



US00D773277S

(12) **United States Design Patent** (10) **Patent No.:** **US D773,277 S**
Houle (45) **Date of Patent:** **** Dec. 6, 2016**

(54) **HANDLE**

(71) Applicant: **PLACEMENTS GASTON HOULE INC., Wickham (CA)**

(72) Inventor: **Gaston Houle, Wickham (CA)**

(73) Assignee: **PLACEMENTS GASTON HOULE INC., Wickham (CA)**

(**) Term: **15 Years**

(21) Appl. No.: **29/532,309**

(22) Filed: **Jul. 6, 2015**

(51) **LOC (10) Cl.** **08-06**

(52) **U.S. Cl.**
USPC **D8/307**

(58) **Field of Classification Search**
USPC D8/301, 302, 313, 315, 316, 318, 319,
D8/320, 331; 16/110.1, 402, 412, 415,
16/416, 443, 444; 292/336.3, 347, 348,
292/DIG. 23, DIG. 53; 70/207, 208, 209,
70/224, 455; D7/393, 394
CPC . Y10T 16/44; Y10T 292/57; Y10T 70/5761;
Y10T 70/5832; Y10T 16/458; Y10T
292/1047; Y10T 16/513; Y10T 70/5889;
Y10T 16/498; Y10T 70/5792; Y10T 16/476;
Y10T 16/86; Y10T 70/7062; Y10T 70/8568;
Y10T 16/4713; Y10T 70/5819; Y10T
70/5155; Y10T 74/20732; Y10T 292/097;
Y10T 292/1059; Y10T 70/7113; Y10T
70/7305; Y10T 292/1014; Y10T 292/1052;
Y10S 292/23; Y10S 292/53; Y10S 292/31;
Y10S 292/64; Y10S 70/31

See application file for complete search history.

(56) **References Cited**

U.S. PATENT DOCUMENTS

D361,256 S * 8/1995 Vennola D8/307
D450,558 S * 11/2001 Ables D8/307
D453,898 S * 2/2002 Barnes D8/307
D550,059 S * 9/2007 Witte D8/302
D682,067 S * 5/2013 Tillet D8/107

* cited by examiner

Primary Examiner — Derrick Holland

Assistant Examiner — Lauren Calve

(74) *Attorney, Agent, or Firm* — Mathieu Audet

(57) **CLAIM**

The ornamental design for a handle, as shown and described.

DESCRIPTION

FIG. 1 is an isometric view of a handle;
FIG. 2 is a bottom plan view thereof;
FIG. 3 is a top plan view thereof;
FIG. 4 is a right elevational view thereof;
FIG. 5 is a left elevational view thereof;
FIG. 6 is a front elevational view thereof; and,
FIG. 7 is a rear elevational view thereof.
The broken lines shown represent unclaimed subject matter
and form no part of the claimed design.

1 Claim, 6 Drawing Sheets

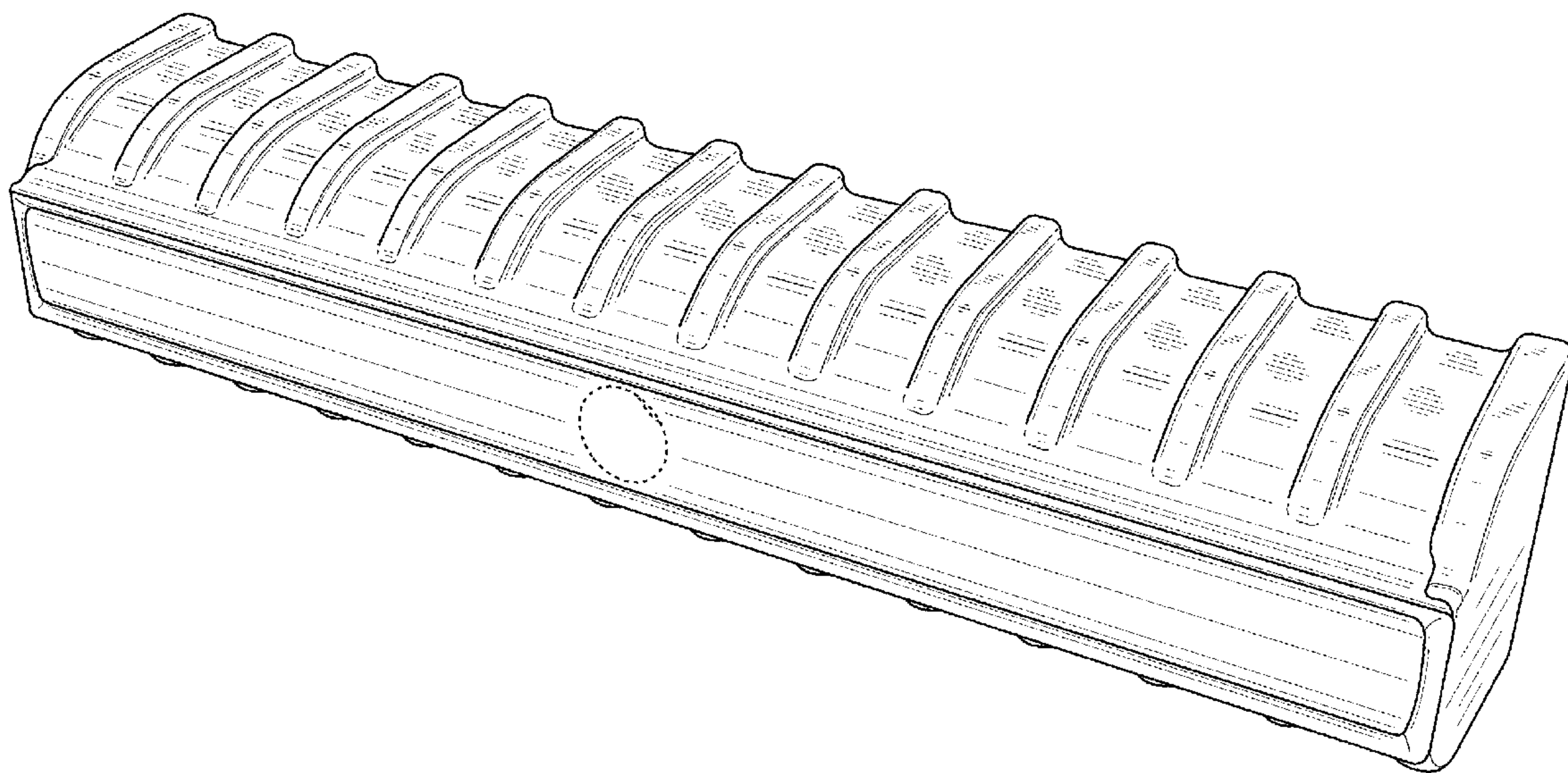

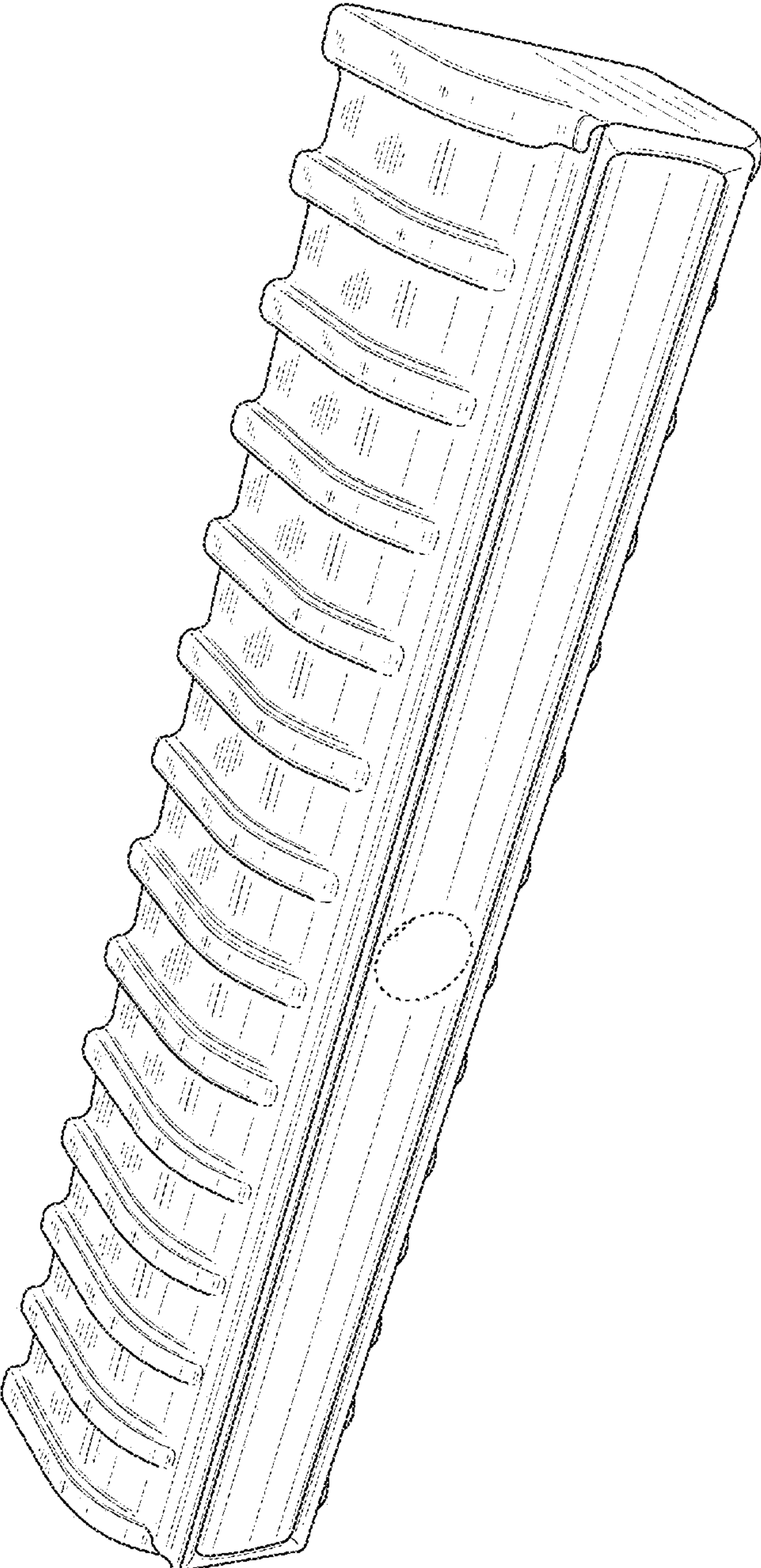

FIG. 1

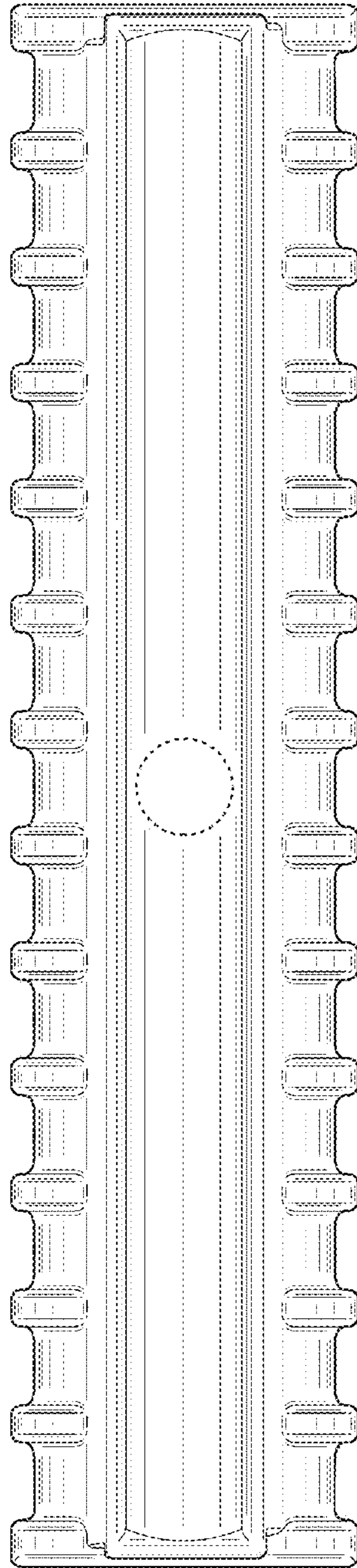

FIG. 2

REPLACEMENT SHEET
Application No.: 29/532,309
Filing Date: 07/06/2015
Confirmation No.: 4139

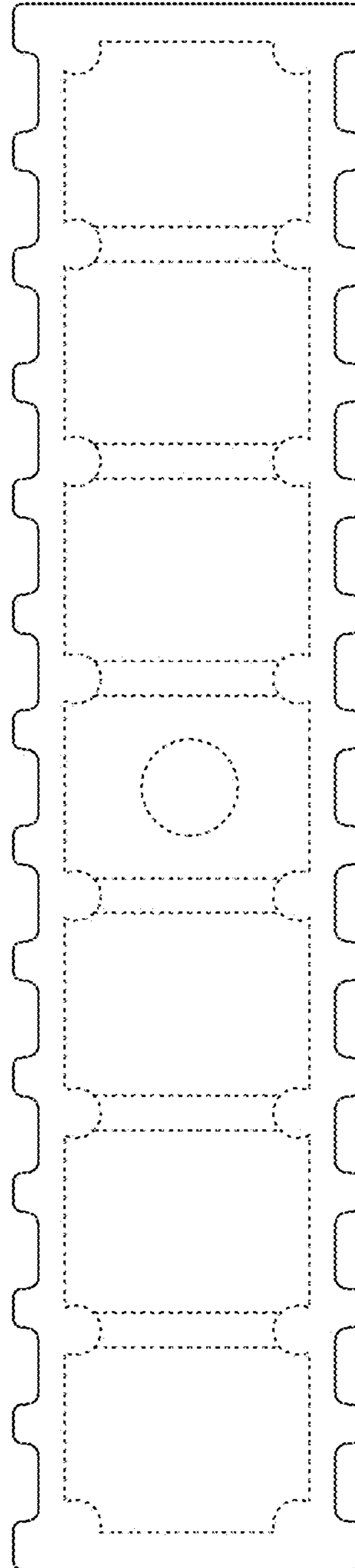

FIG. 3

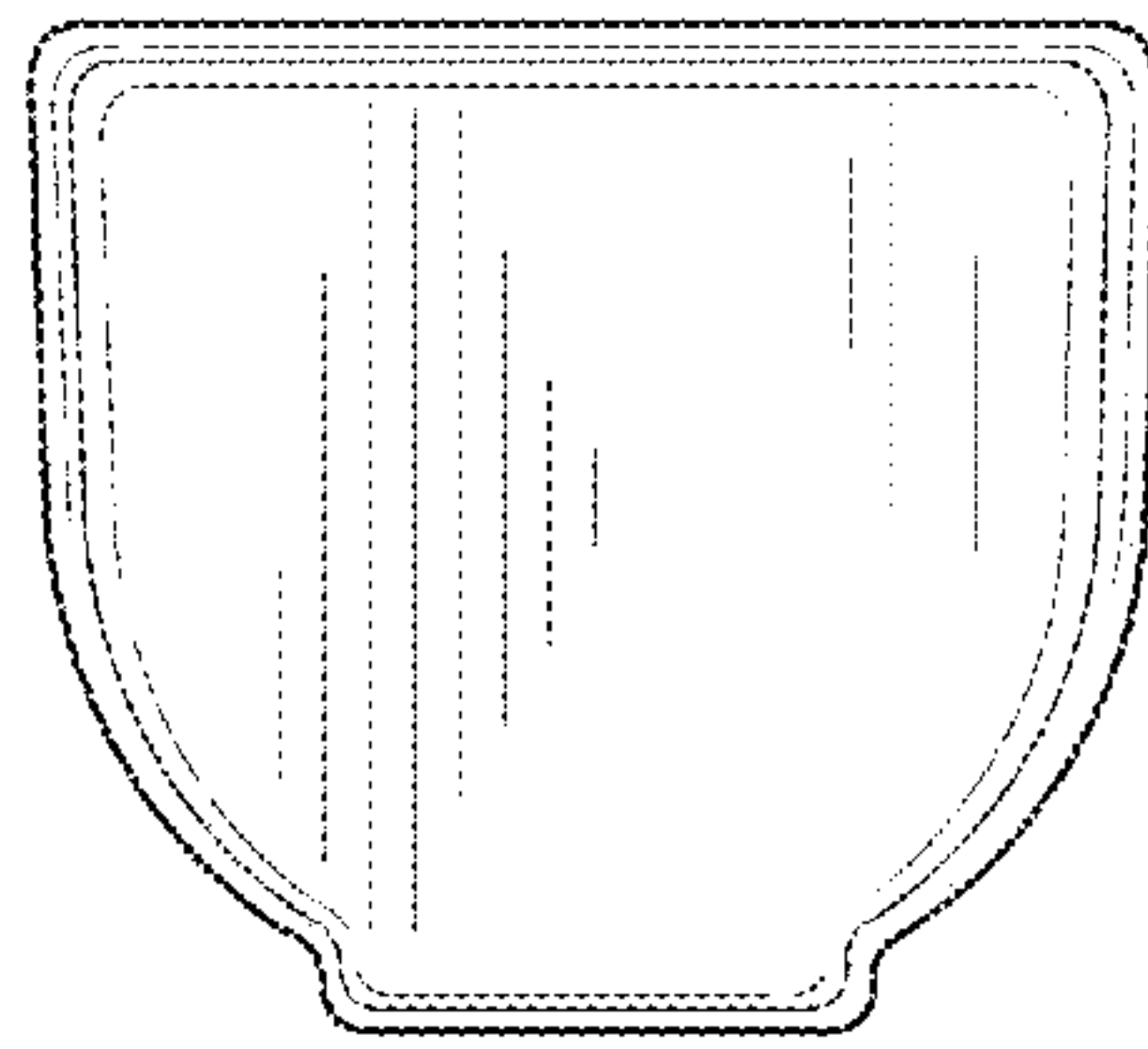

FIG. 5

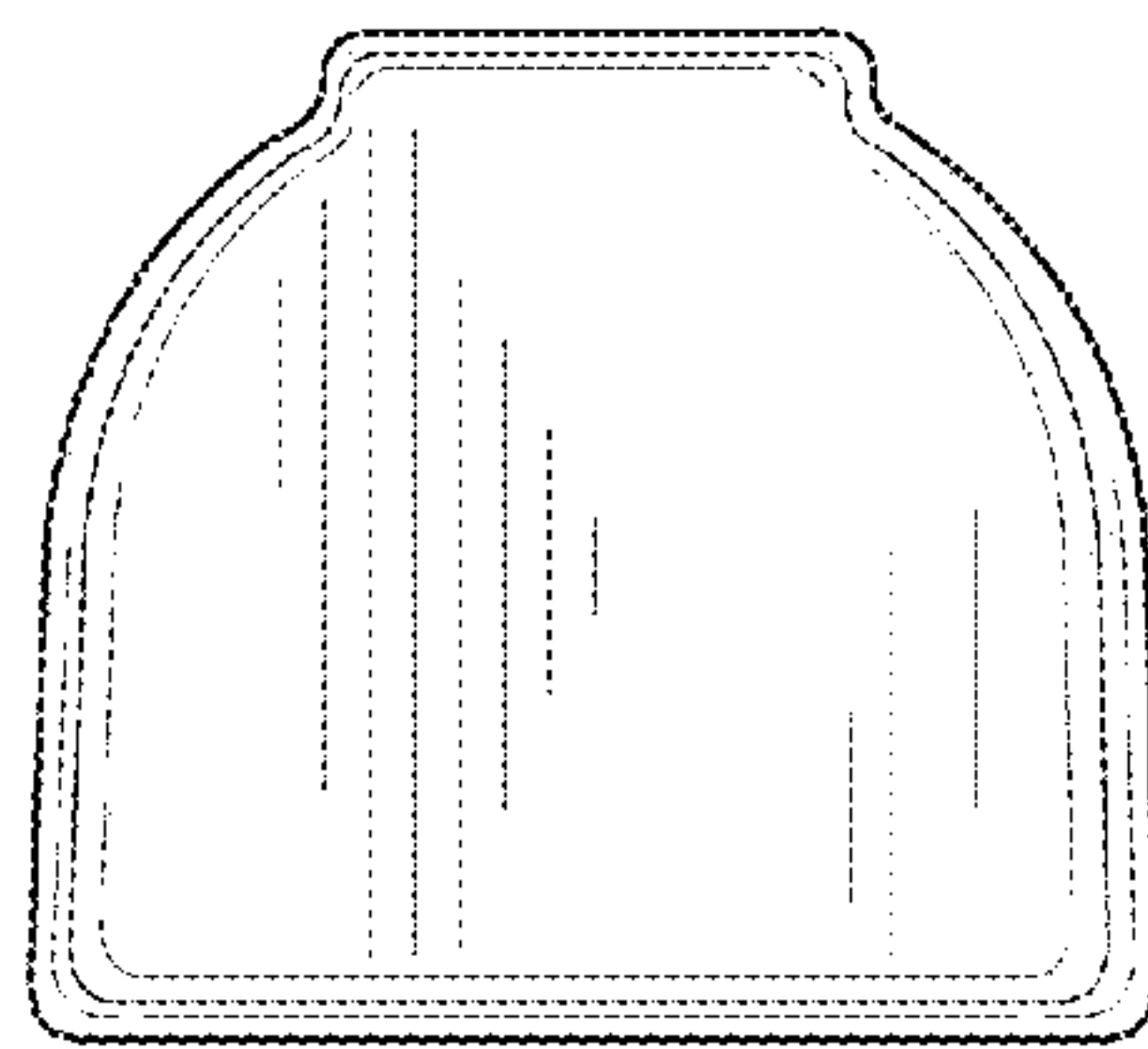

FIG. 4

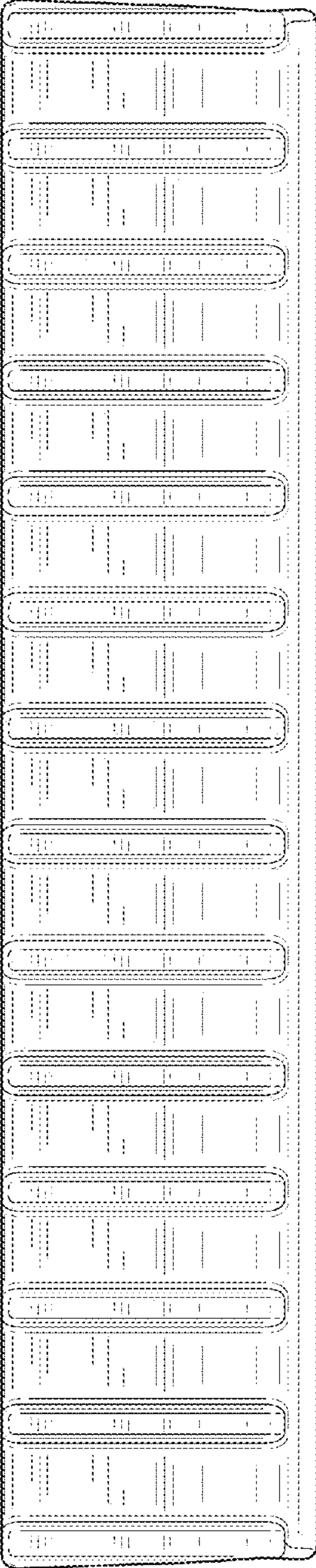

FIG. 6

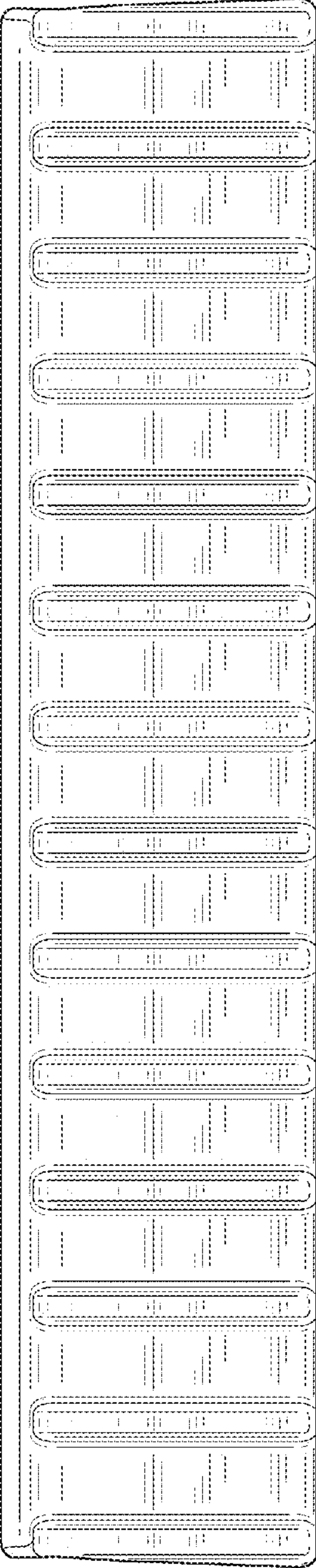

FIG. 7