



US00D773261S

(12) **United States Design Patent**
Ward

(10) **Patent No.:** **US D773,261 S**
(45) **Date of Patent:** **** Dec. 6, 2016**

- (54) **SHOVEL WITH BACKSTOP AND ADJUSTABLE HEAD**
- (71) Applicant: **Brian J. Ward**, Harrodsburg, KY (US)
- (72) Inventor: **Brian J. Ward**, Harrodsburg, KY (US)
- (**) Term: **14 Years**
- (21) Appl. No.: **29/516,120**
- (22) Filed: **Jan. 29, 2015**
- (51) **LOC (10) Cl.** **08-01**
- (52) **U.S. Cl.**
USPC **D8/10**
- (58) **Field of Classification Search**
USPC D8/1, 7, 10; D21/398, 532
CPC A01B 1/00; A01B 1/02; A01B 1/022;
A01B 1/026; B25G 1/102; B25G
1/04; B25G 1/00; Y10T 16/4713
See application file for complete search history.

(56) **References Cited**

U.S. PATENT DOCUMENTS

173,964 A *	2/1876	Wheeler	E01H 5/02 294/54.5
D31,473 S *	8/1899	Jones	D8/10
2,098,609 A	11/1937	Bishop	
2,396,089 A *	3/1946	Cross	E01H 5/02 209/419
2,598,952 A *	6/1952	Weingart	E01H 5/02 280/47.24
4,264,095 A	4/1981	Lemasters	
4,787,661 A	11/1988	Rutledge	
D314,318 S *	2/1991	Uimonen	D8/10
5,727,831 A *	3/1998	Dritlein, Jr.	A01B 1/02 294/51

5,810,408 A	9/1998	Armstrong	
D434,284 S *	11/2000	Gracy	D8/1
6,290,273 B1	9/2001	Moisan	
6,315,341 B1	11/2001	Leon et al.	
6,457,757 B2	10/2002	Hendrick	
D506,654 S *	6/2005	Costa	D8/10
7,032,941 B2	4/2006	Heneveld	
7,070,006 B2 *	7/2006	Villani	A01B 1/02 172/371
D585,252 S *	1/2009	Mullen	D8/7
D604,572 S *	11/2009	Randolph	D8/10
D608,610 S *	1/2010	Boies	D8/7
D688,540 S *	8/2013	Sheinberg Frenkel	D8/10
D688,541 S *	8/2013	Frenkel	D8/10
D699,086 S *	2/2014	Christopher	D8/10
D723,888 S *	3/2015	Pope	D8/7

* cited by examiner

Primary Examiner — Ian Simmons
Assistant Examiner — Ieisha Price
(74) *Attorney, Agent, or Firm* — Robert C. Montgomery;
Montgomery Patent & Design LP.

(57) **CLAIM**

The ornamental design for a shovel with backstop and adjustable head, as shown and described.

DESCRIPTION

FIG. 1 is an isometric view of a shovel with backstop and adjustable head.
FIG. 2 is a front view thereof;
FIG. 3 is a rear view thereof;
FIG. 4 a left-hand side view thereof;
FIG. 5 is a right-hand side view thereof;
FIG. 6 is a top view thereof; and,
FIG. 7 is a bottom view thereof.

1 Claim, 4 Drawing Sheets

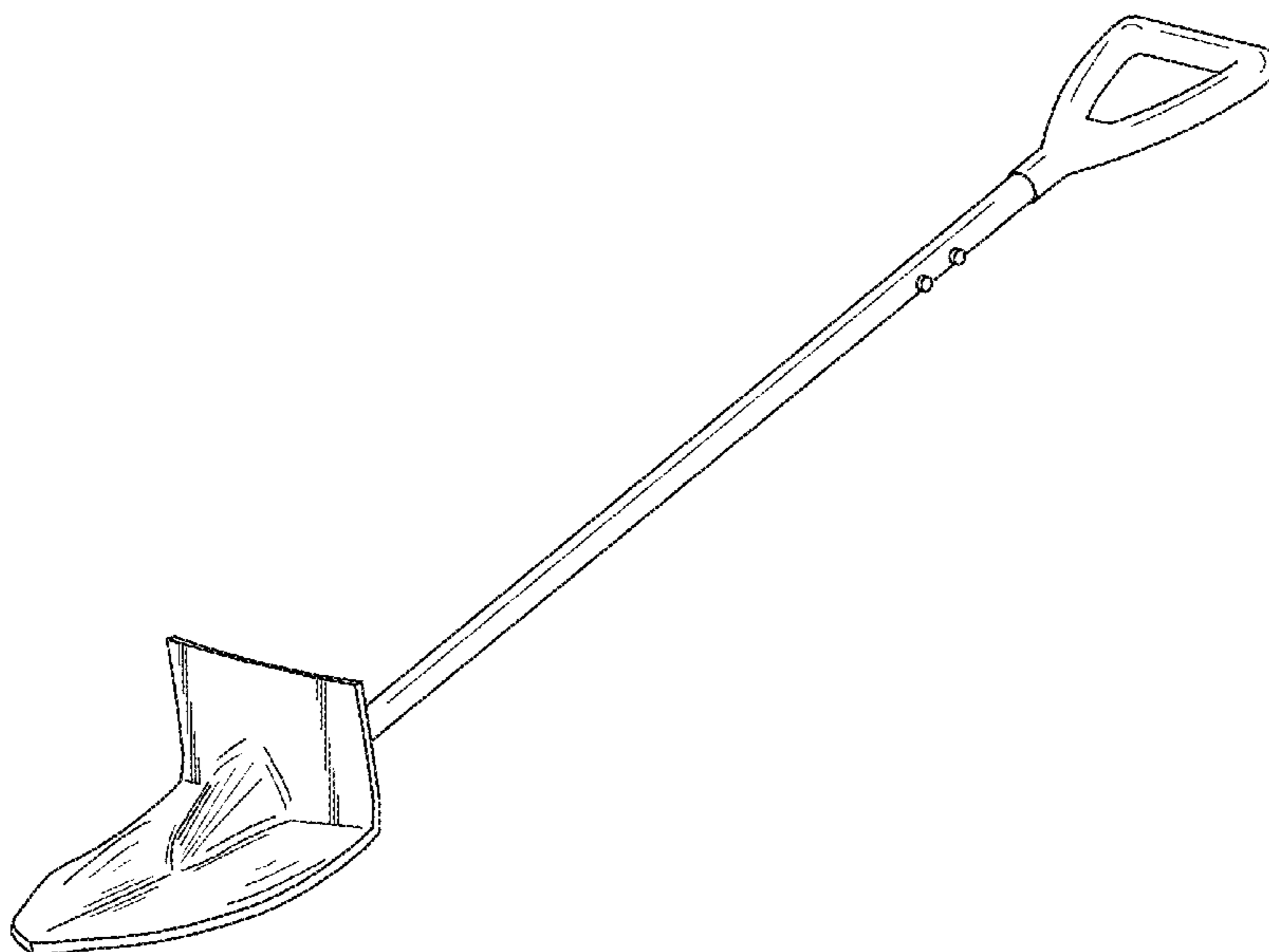

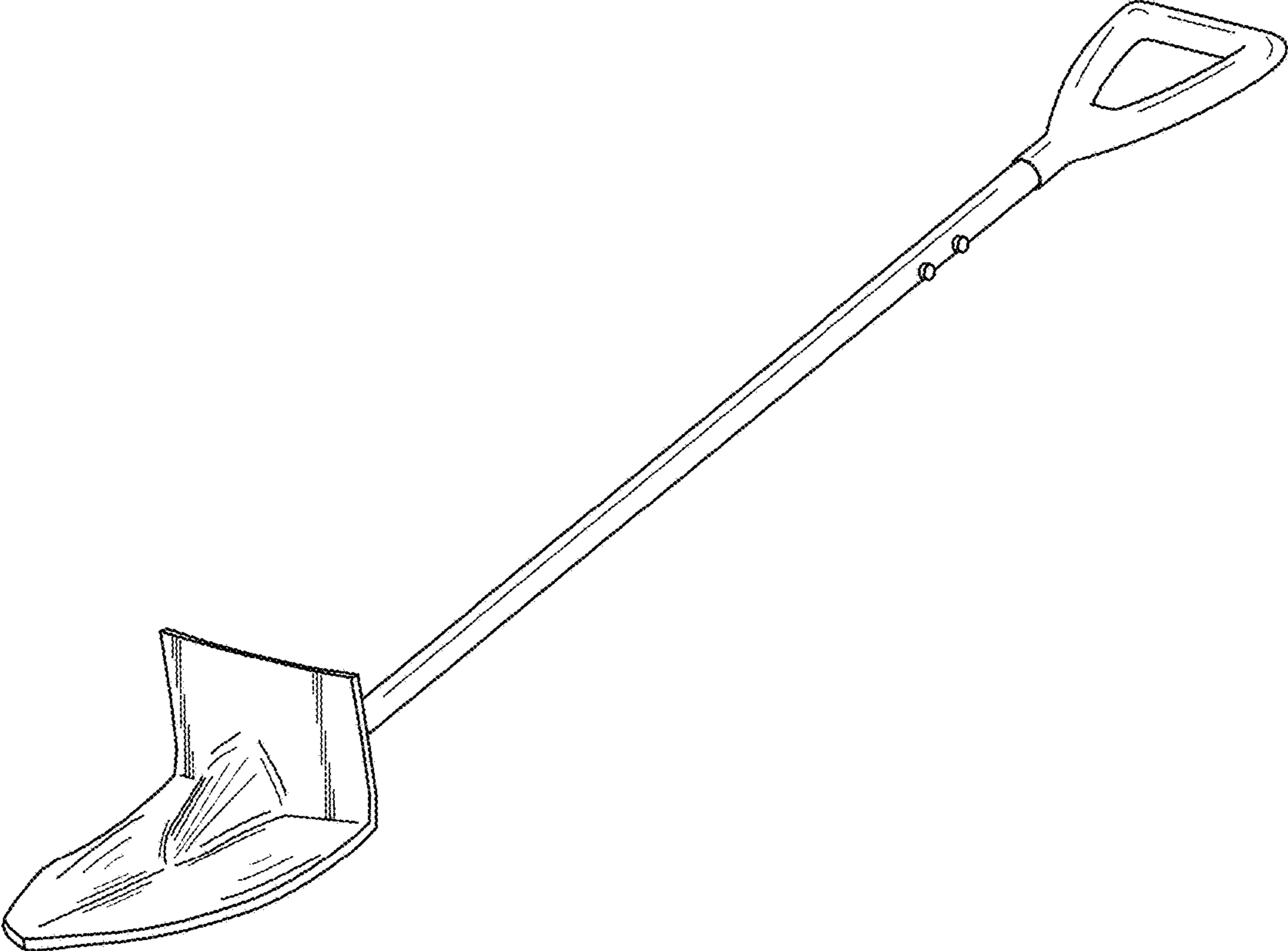

Fig. 1

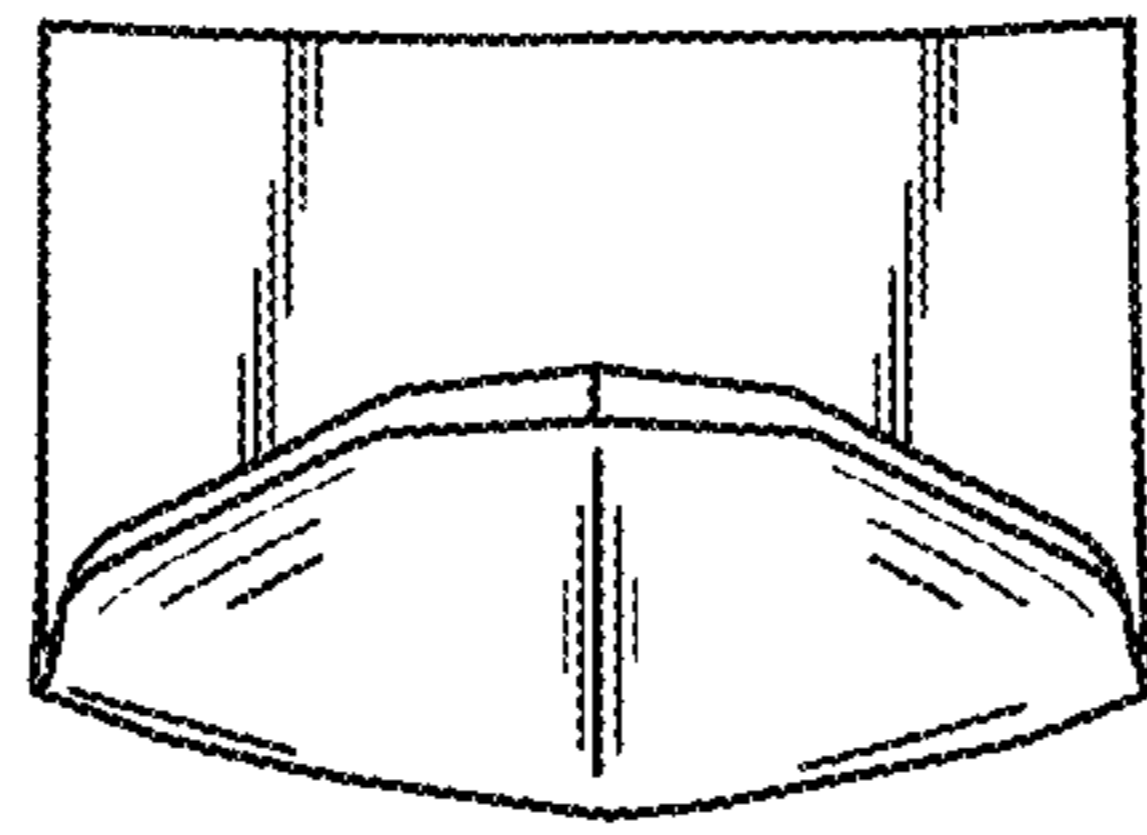

Fig. 2

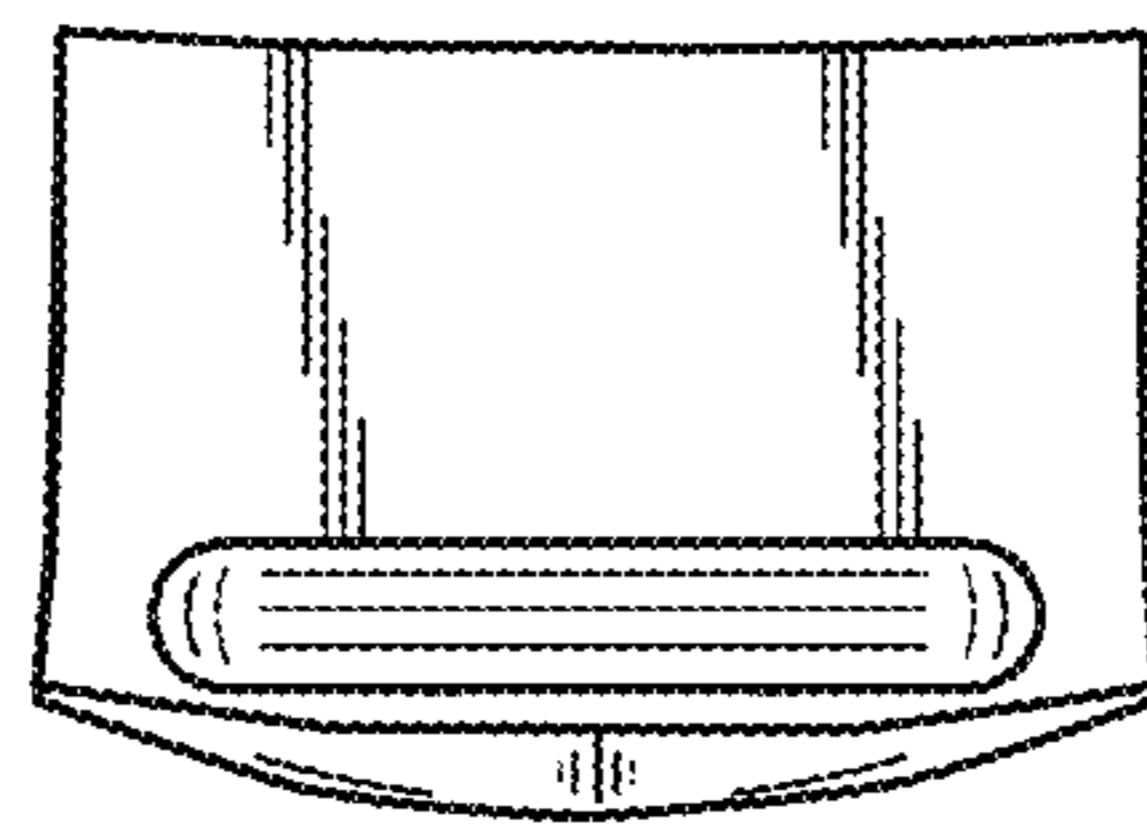

Fig. 3

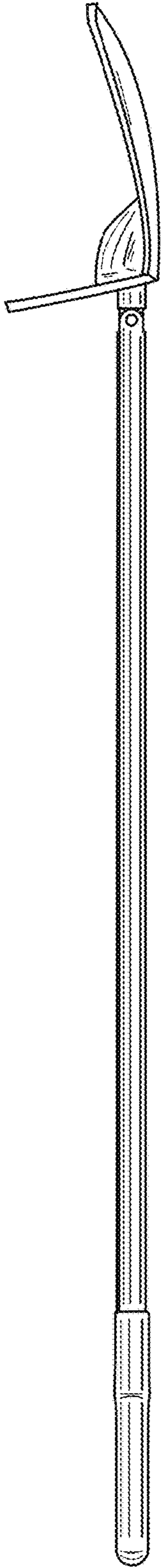

Fig. 4

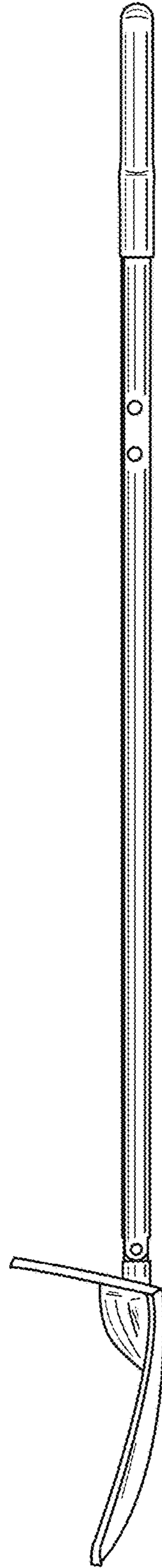

Fig. 5

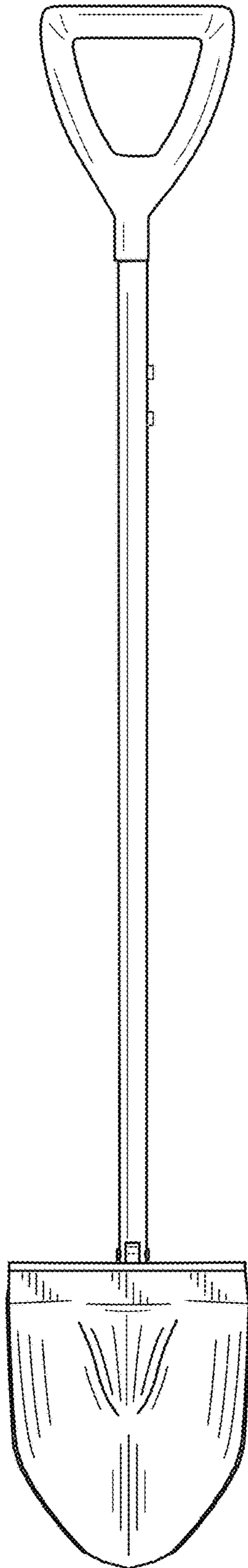

Fig. 6

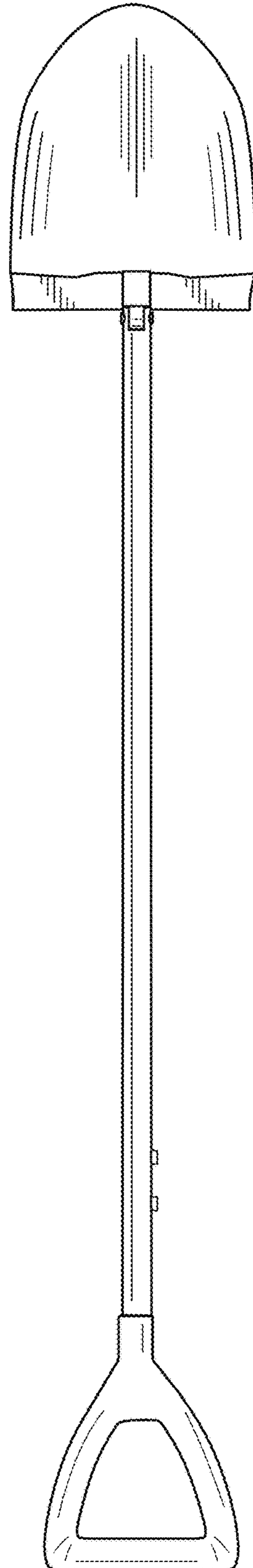

Fig. 7