



US00D773172S

(12) **United States Design Patent** (10) **Patent No.:** **US D773,172 S**
Blythe (45) **Date of Patent:** **** Dec. 6, 2016**

(54) **SPORTS BAND**

(71) Applicant: **Drymax Technologies Inc.**, Paso Robles, CA (US)

(72) Inventor: **William A. Blythe**, Paso Robles, CA (US)

(73) Assignee: **DRYMAX TECHNOLOGIES, INC.**, Paso Robles, CA (US)

(**) Term: **14 Years**

(21) Appl. No.: **29/519,915**

(22) Filed: **Mar. 9, 2015**

(51) **LOC (10) Cl.** **02-99**

(52) **U.S. Cl.**
USPC **D2/999**

(58) **Field of Classification Search**
USPC D2/621, 623, 744, 747, 853, 976, 985,
D2/986, 992, 993, 994, 999; D11/3, 4, 15;
2/162, 169, 917
CPC A41D 13/08; A41D 19/00; A41D 19/015;
A41D 19/02; A41F 1/06
See application file for complete search history.

(56) **References Cited**

U.S. PATENT DOCUMENTS

243,252 A 6/1881 Harbison
413,749 A * 10/1889 Carrier D04D 5/00
112/409

(Continued)

FOREIGN PATENT DOCUMENTS

AU 2007245238 A1 11/2007
AU 2008200440 A1 3/2010

(Continued)

OTHER PUBLICATIONS

“Nike Adult Fielder’s Wrist Guard” First comment: Oct. 8, 2013.
Baseball Savings. <http://reviews.baseballsavings.com/9058/41799/nike-adult-fielders-wrist-guard-reviews/reviews.htm>.*

(Continued)

Primary Examiner — Manpreet Matharu

Assistant Examiner — Suzanne Tisdell

(74) *Attorney, Agent, or Firm* — Christopher J. Knors;
Moore & Van Allen PLLC

(57) **CLAIM**

The ornamental design for an sports band, as shown and described.

DESCRIPTION

FIG. 1 is a perspective view of a first embodiment of a sports band in accordance with our new design;
FIG. 2 first end view showing of the design of FIG. 1;
FIG. 3 is a second end view thereof;
FIG. 4 is a first side view thereof;
FIG. 5 is a second side view thereof, the view rotated 180 degrees relative to the first side view;
FIG. 6 is a top plan view thereof;
FIG. 7 is a bottom plan view thereof; and
FIG. 8 is a perspective view of the sports band of FIG. 1 being worn on a human wrist;
FIG. 9 is a perspective view of a second embodiment of a sports band in accordance with our new design;
FIG. 10 first end view showing of the design of FIG. 9;
FIG. 11 is a second end view thereof;
FIG. 12 is a first side view thereof;
FIG. 13 is a second side view thereof, the view rotated 180 degrees relative to the first side view;
FIG. 14 is a top plan view thereof;
FIG. 15 is a bottom plan view thereof; and,
FIG. 16 is a perspective view of the sports band of FIG. 9 being worn on a human wrist.
The broken lines shown in the drawings are shown for illustrative purposes only and form no part of the claimed design. In addition, the surface shading, if any, illustrated in the drawings is provided merely to highlight the contour of the design; it is not intended to be illustrative of texture or gloss.

1 Claim, 10 Drawing Sheets

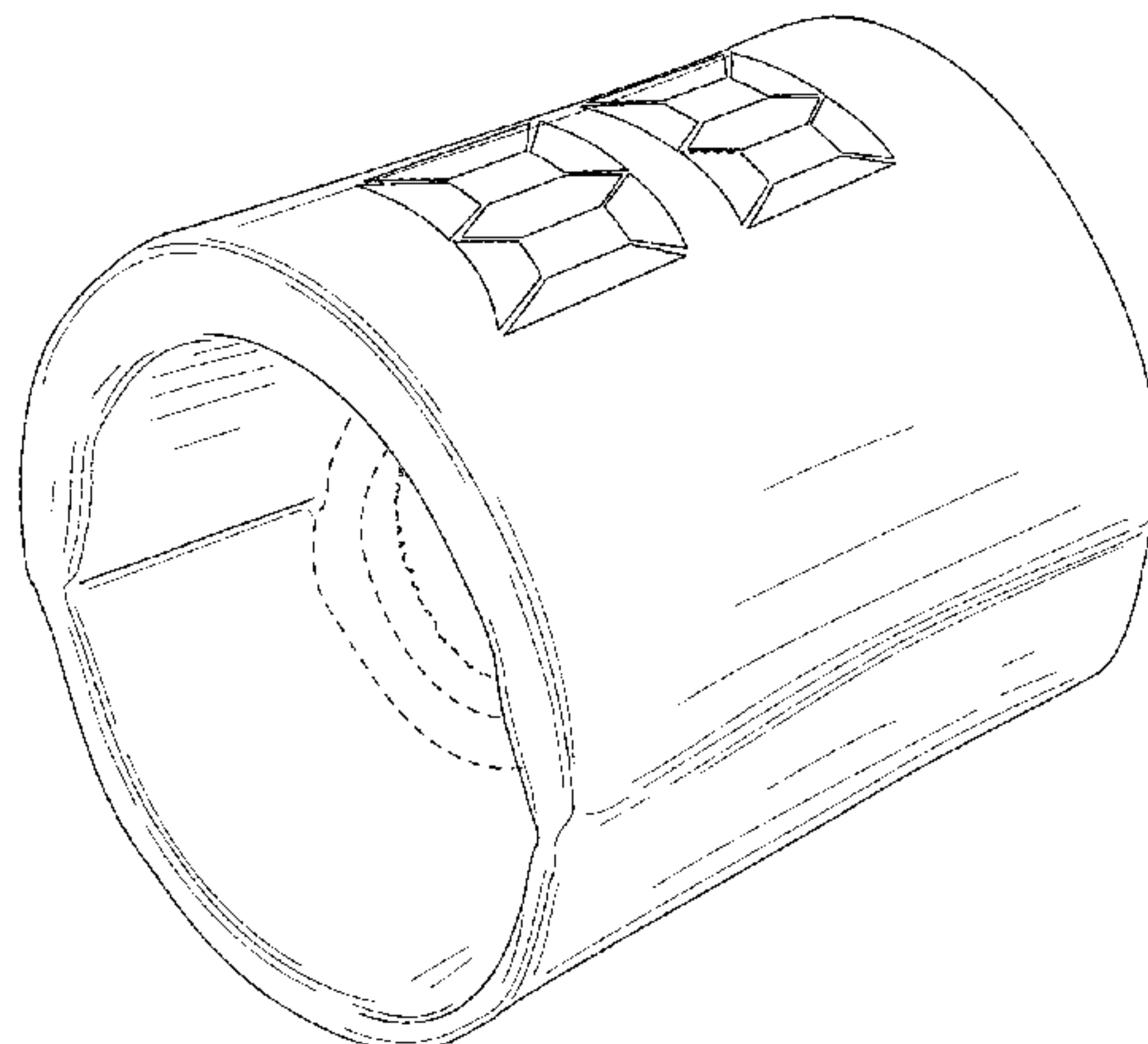

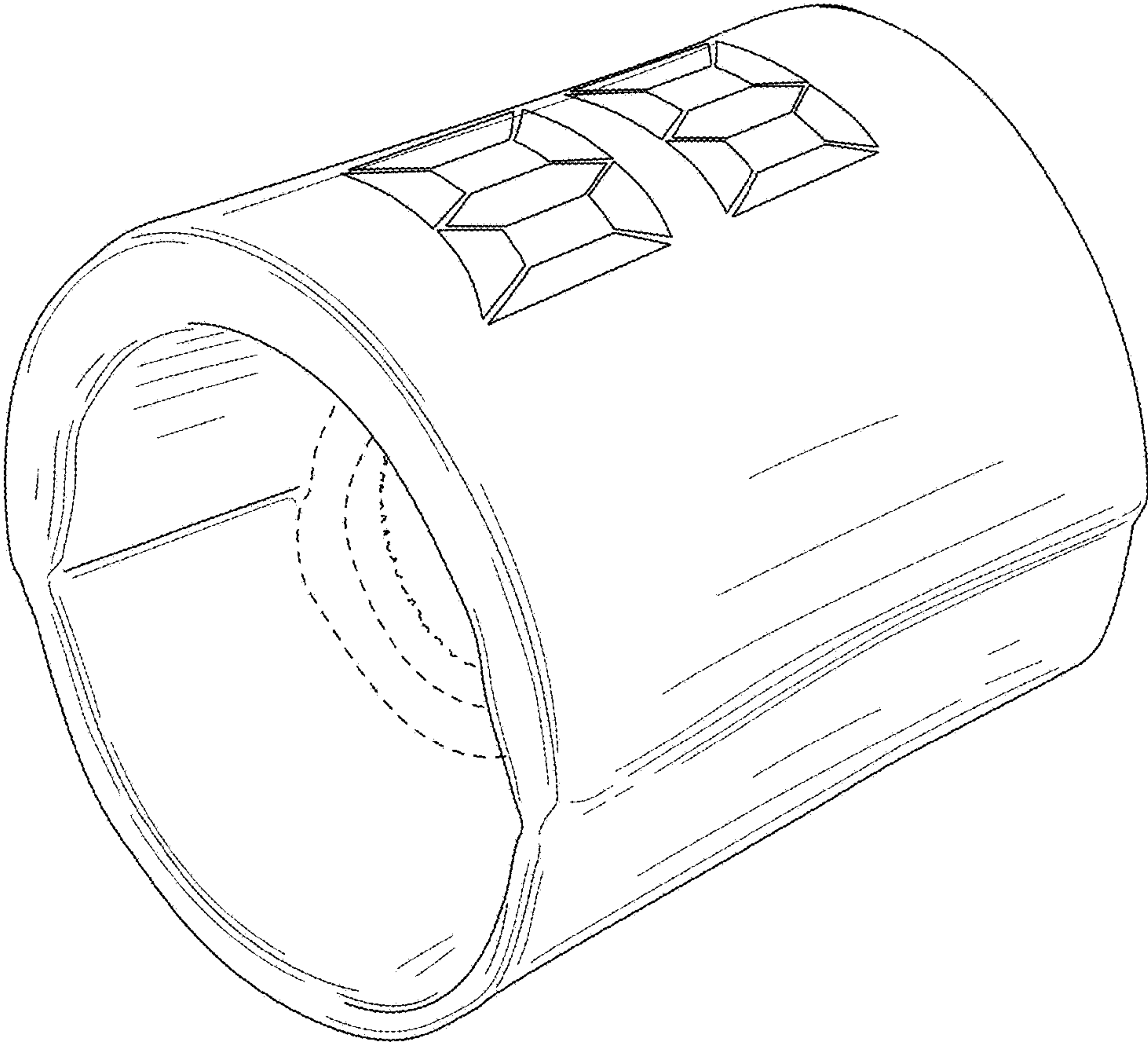

FIG. 1

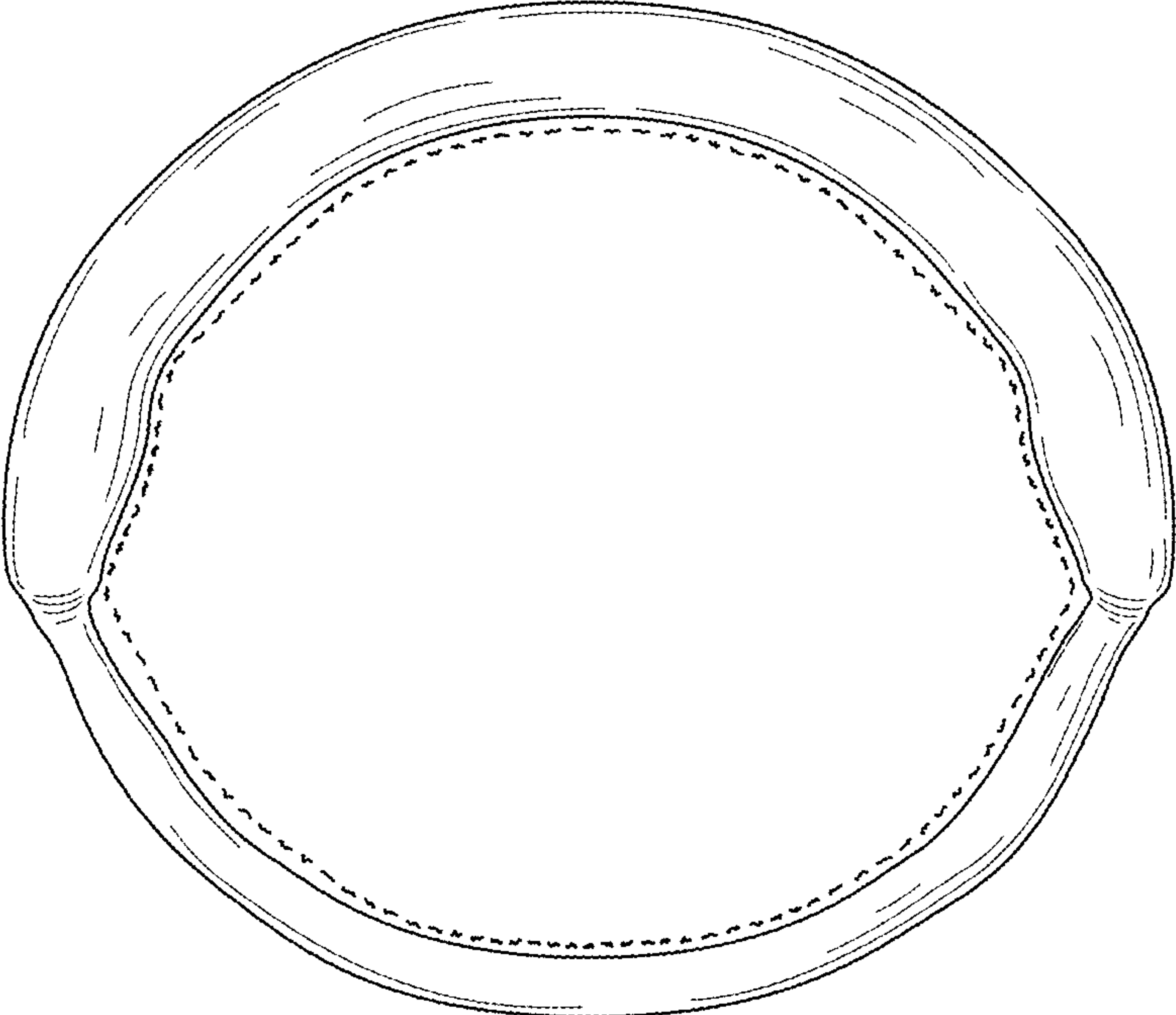

FIG. 2

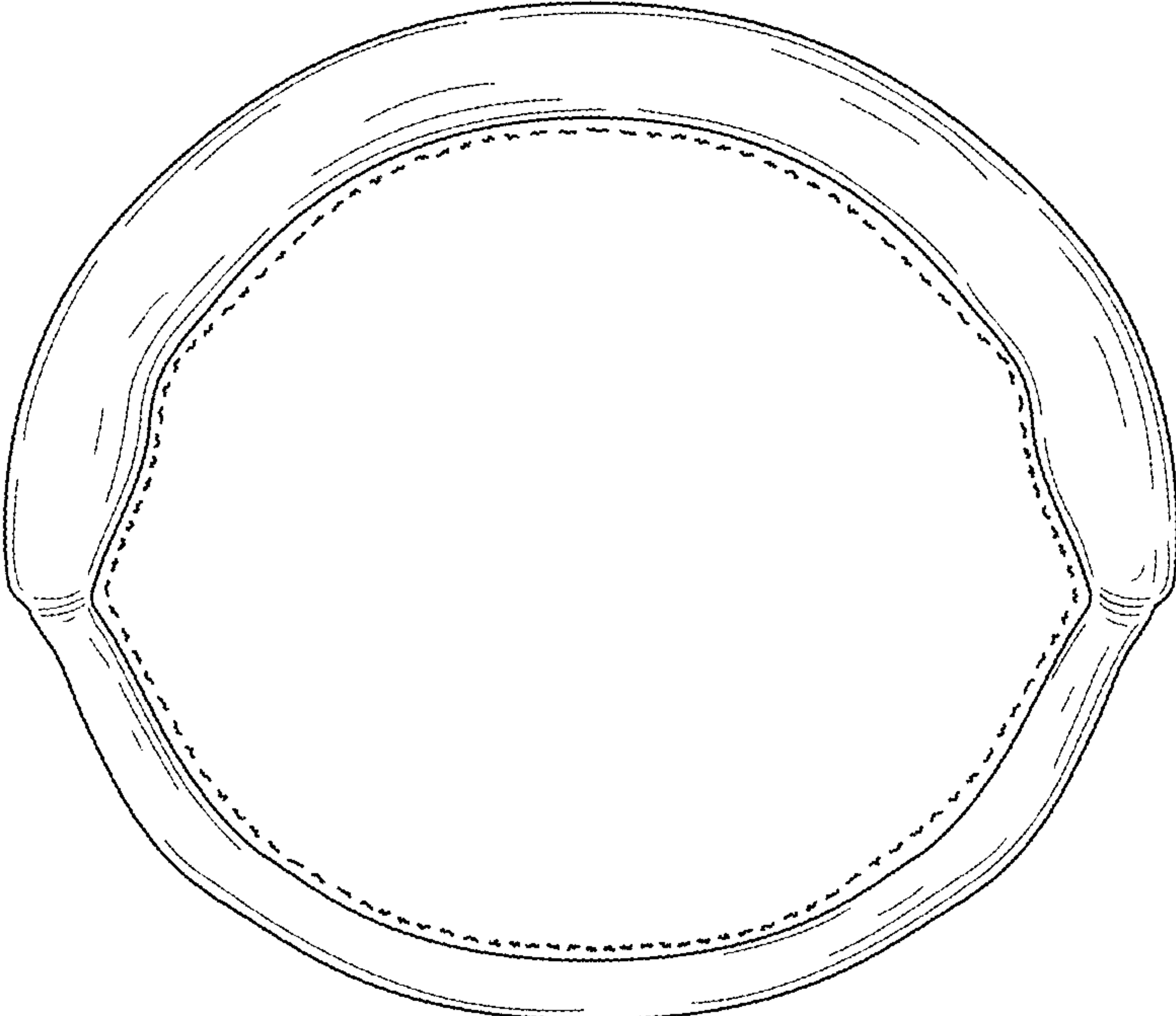

FIG. 3

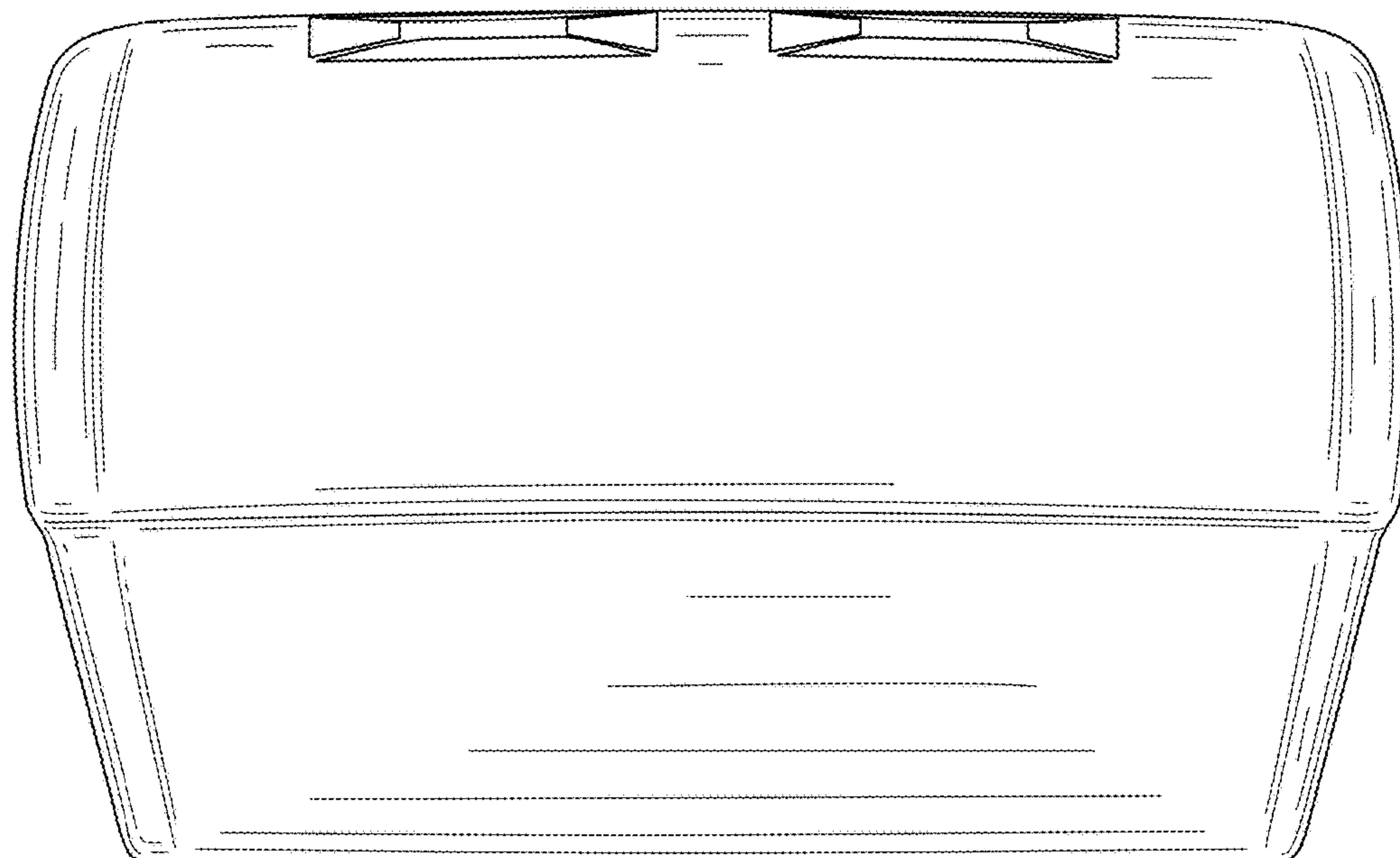

FIG. 4

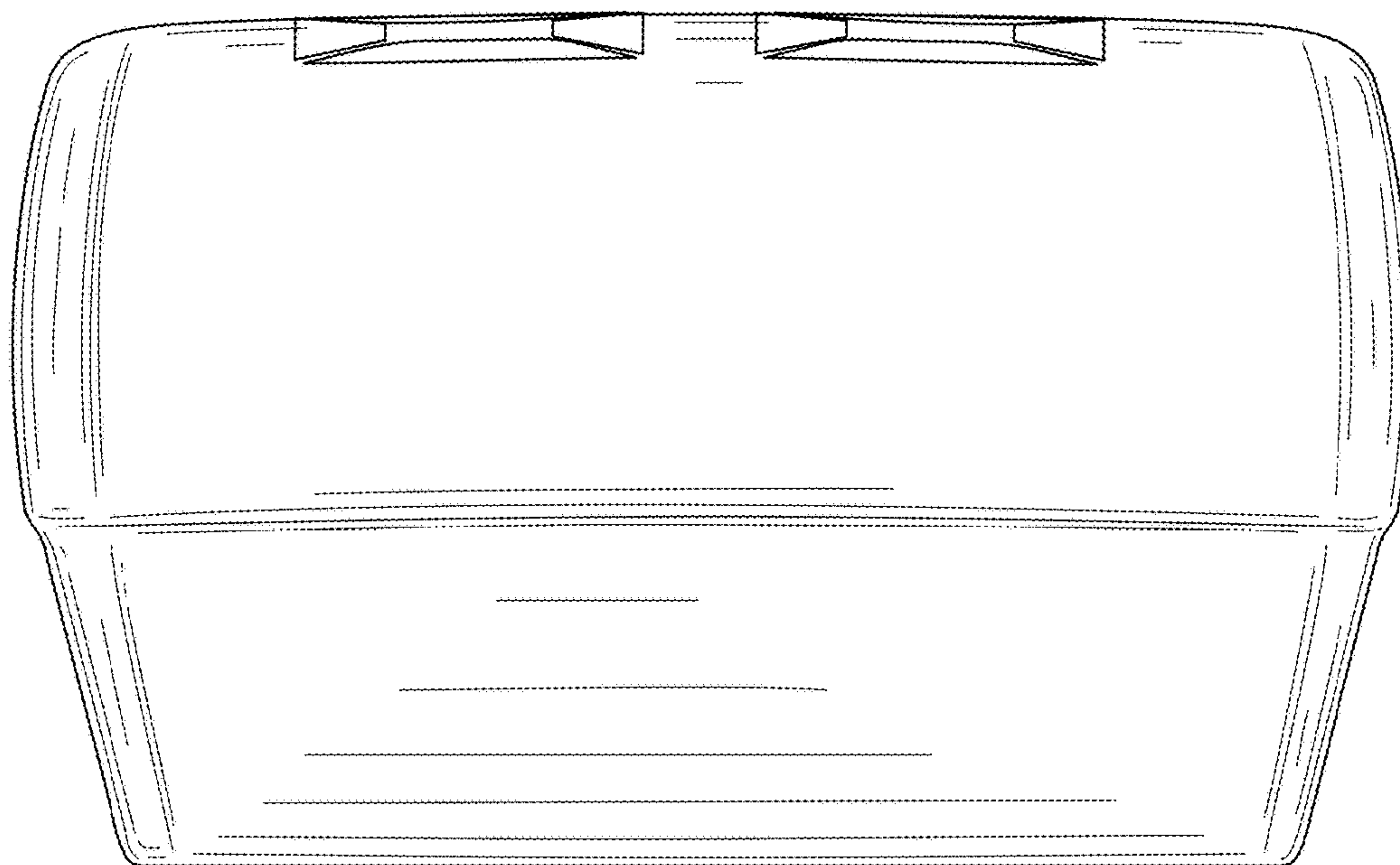

FIG. 5

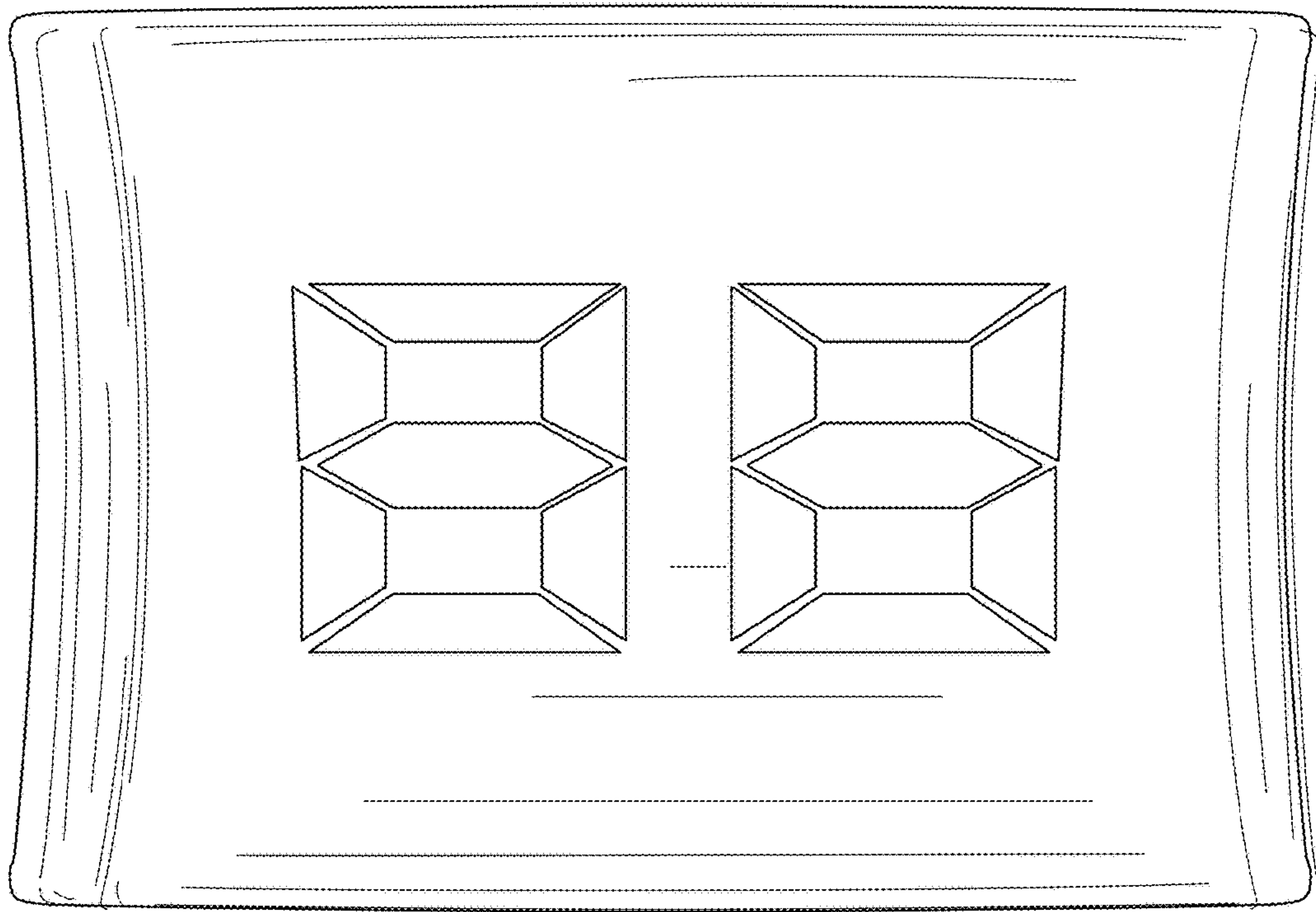

FIG. 6

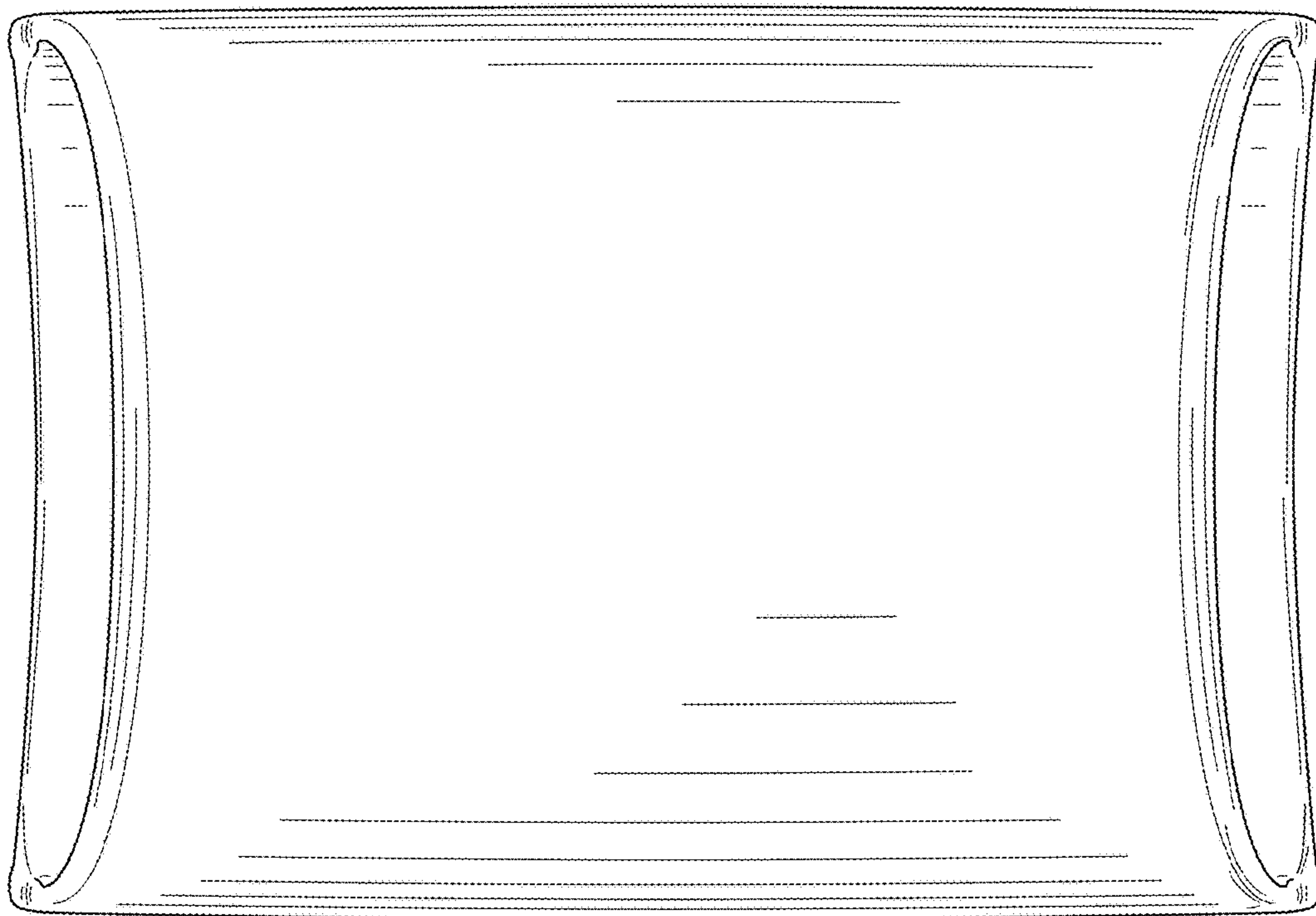

FIG. 7

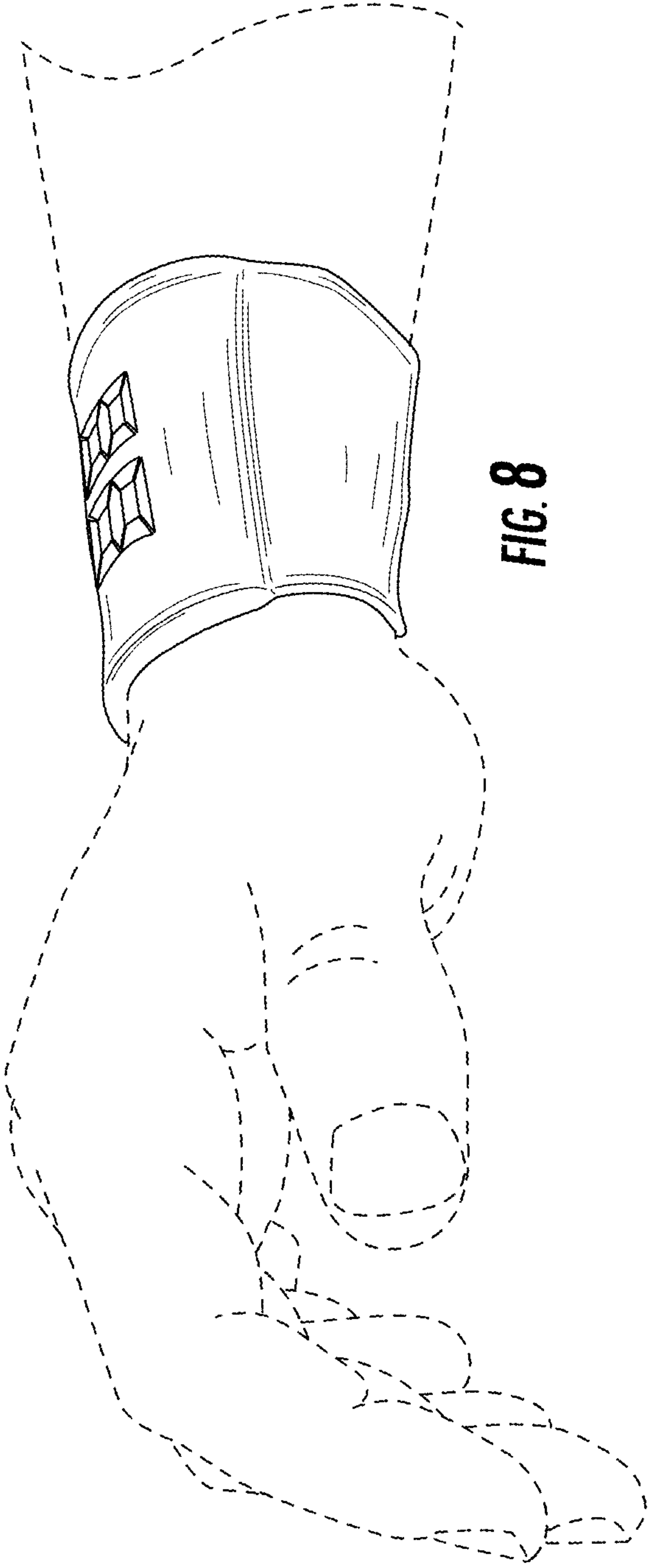

FIG. 8

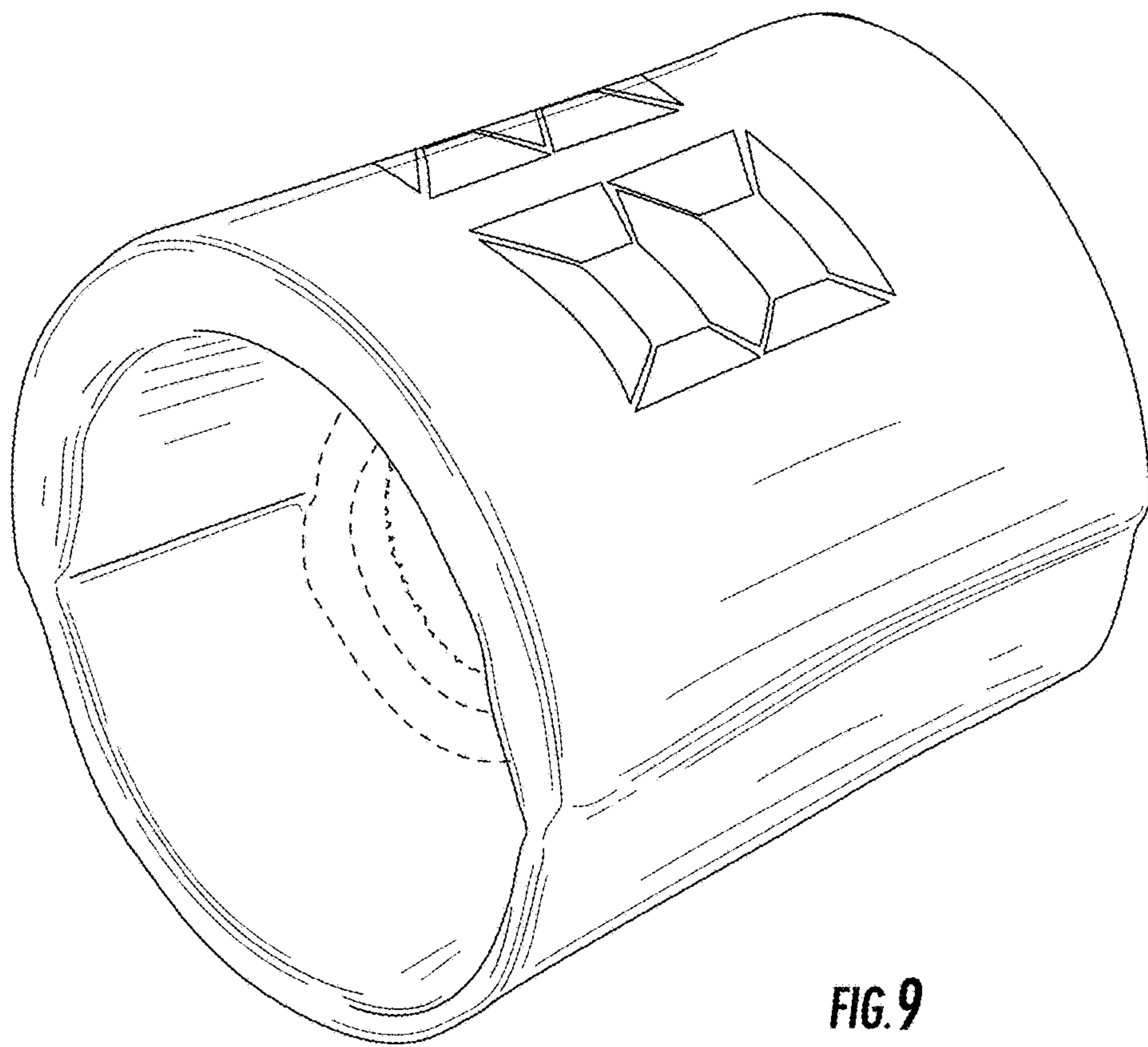

FIG. 9

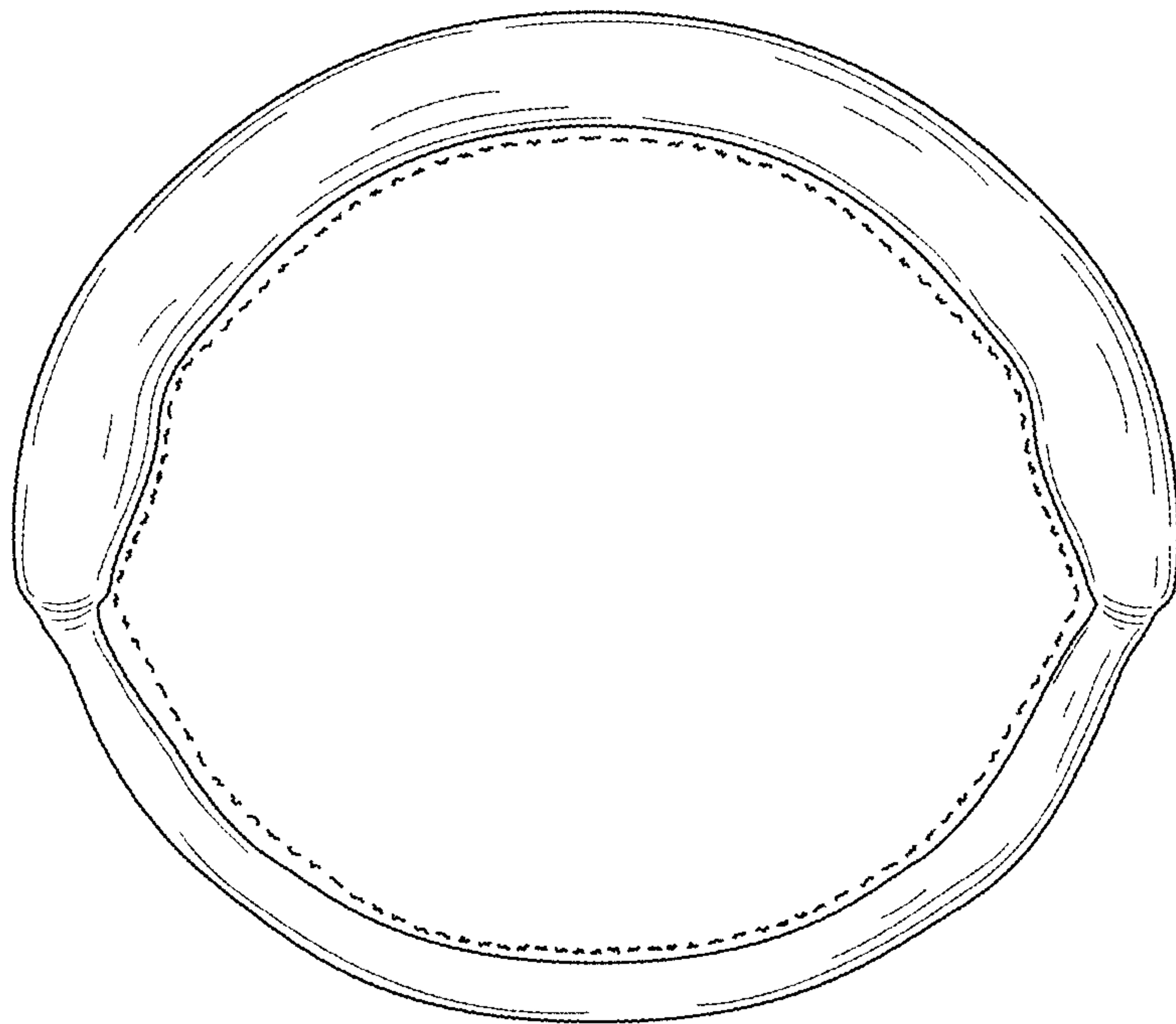

FIG. 10

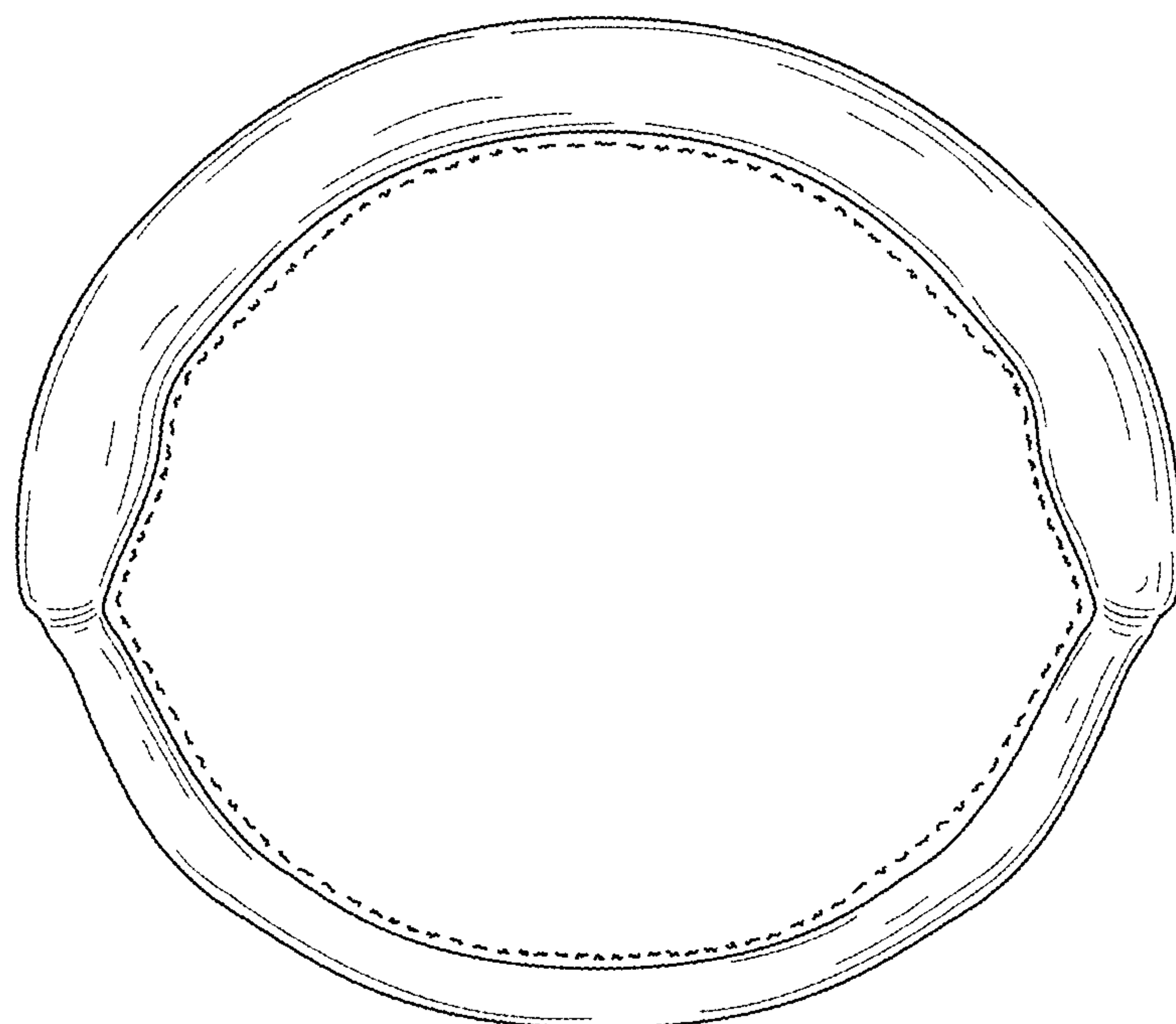

FIG. 11

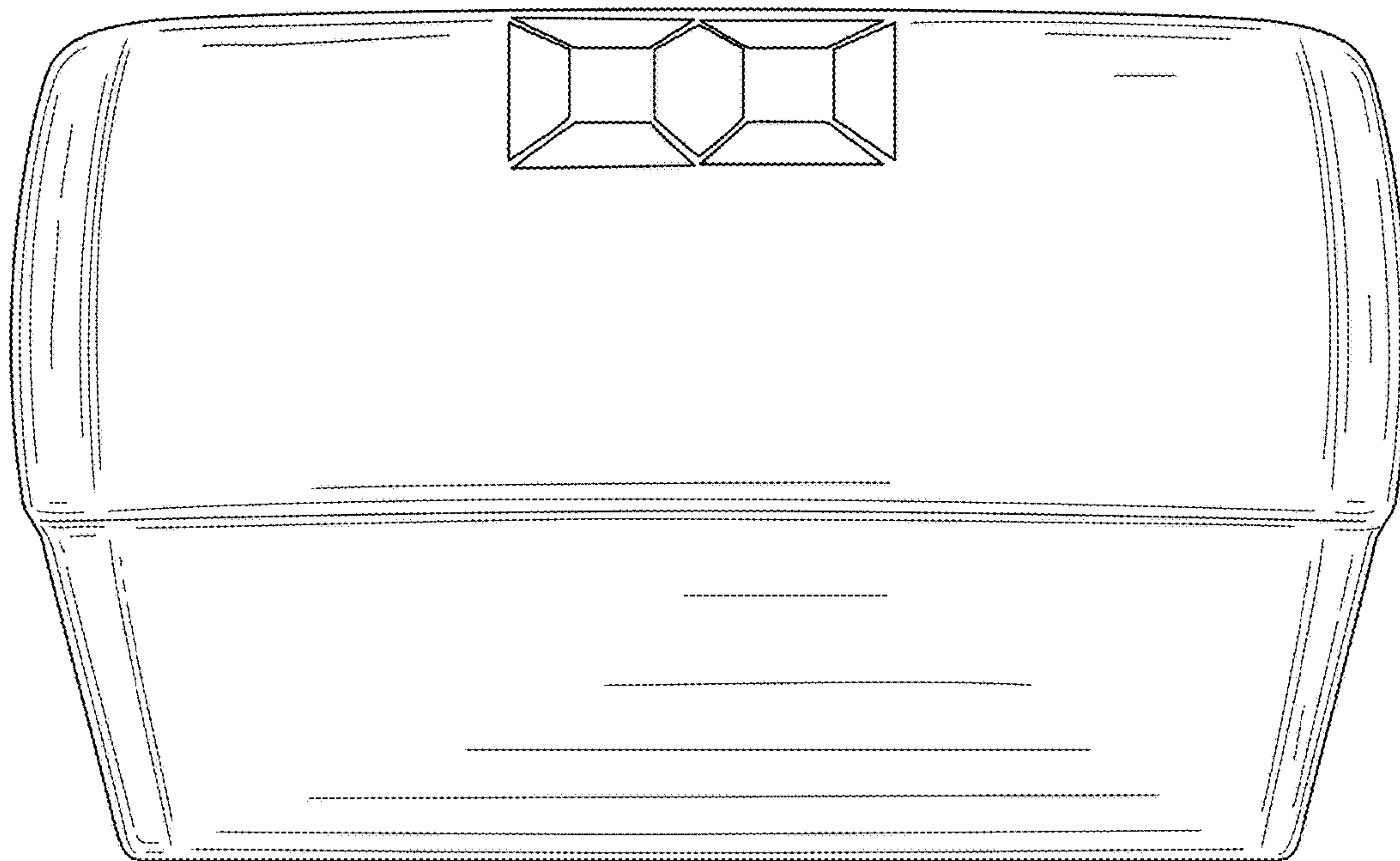

FIG. 12

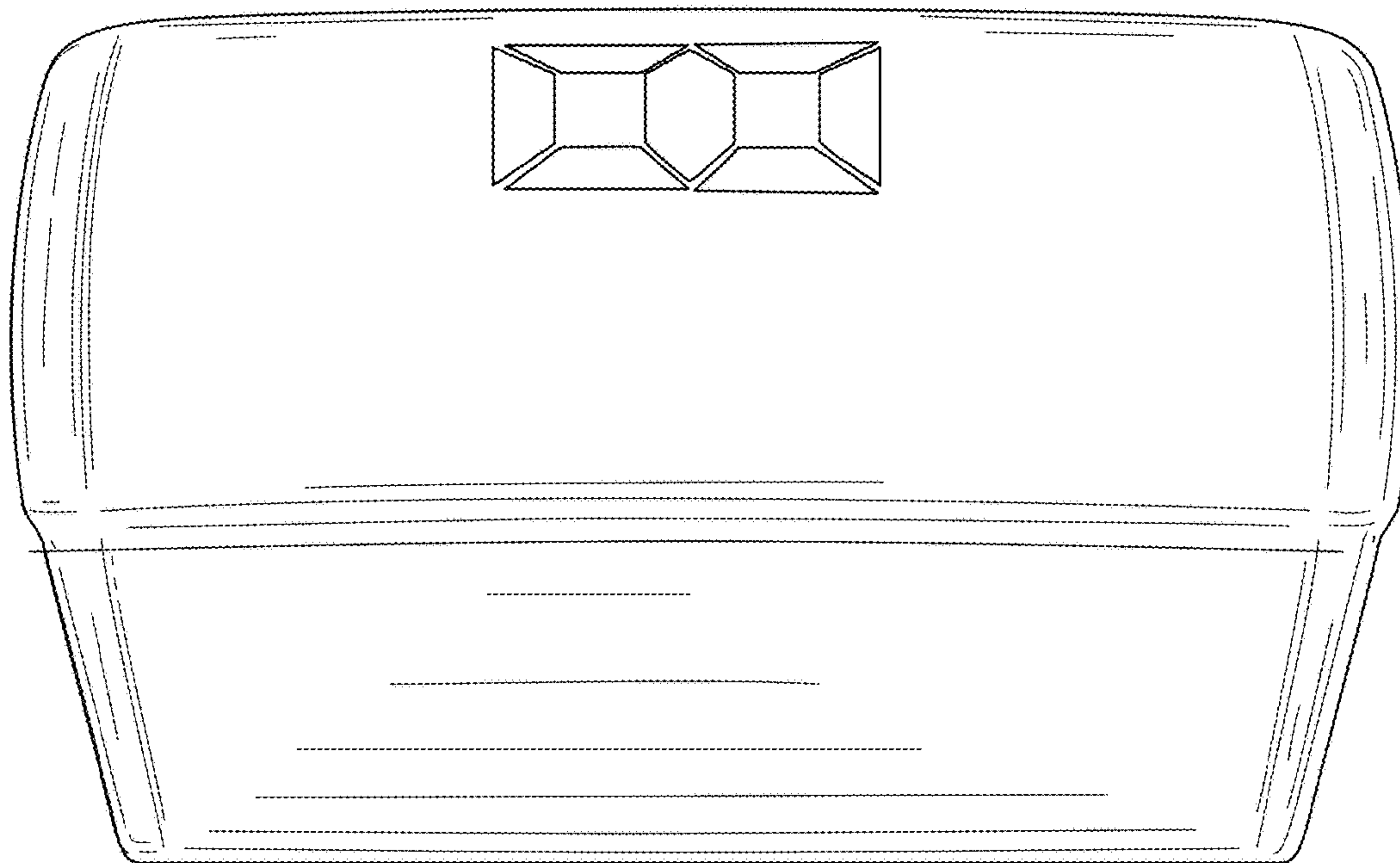

FIG. 13

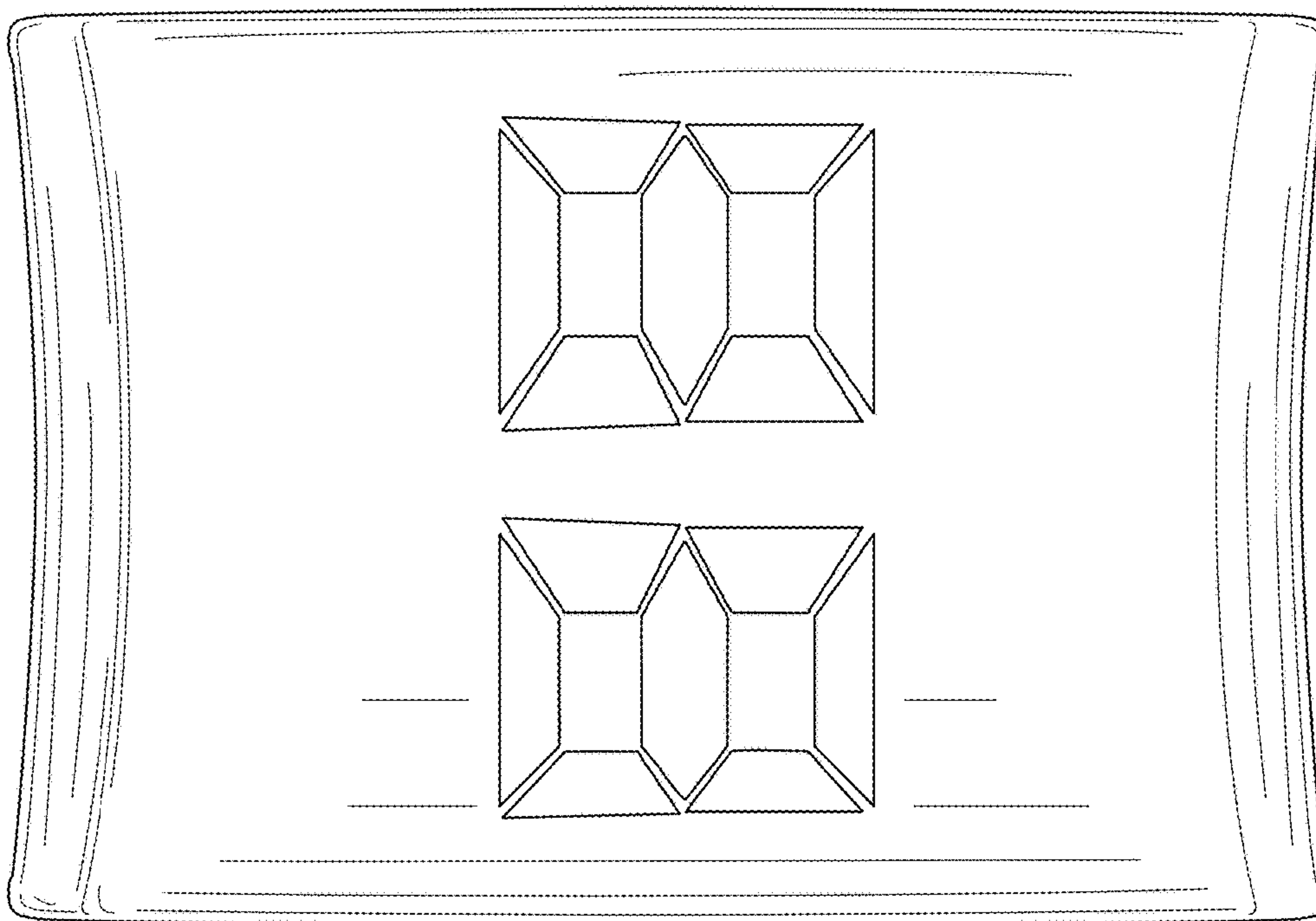

FIG. 14

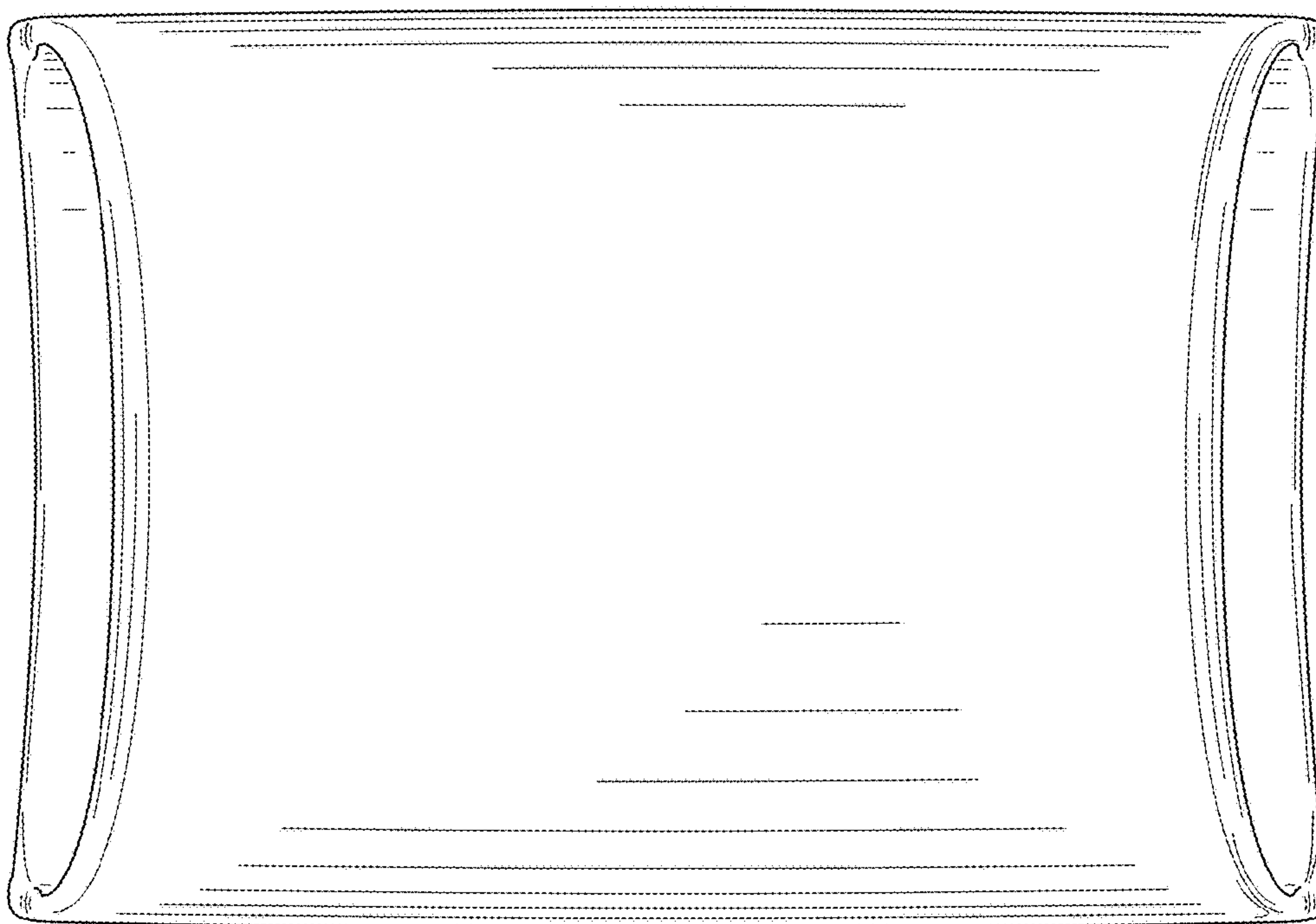

FIG. 15

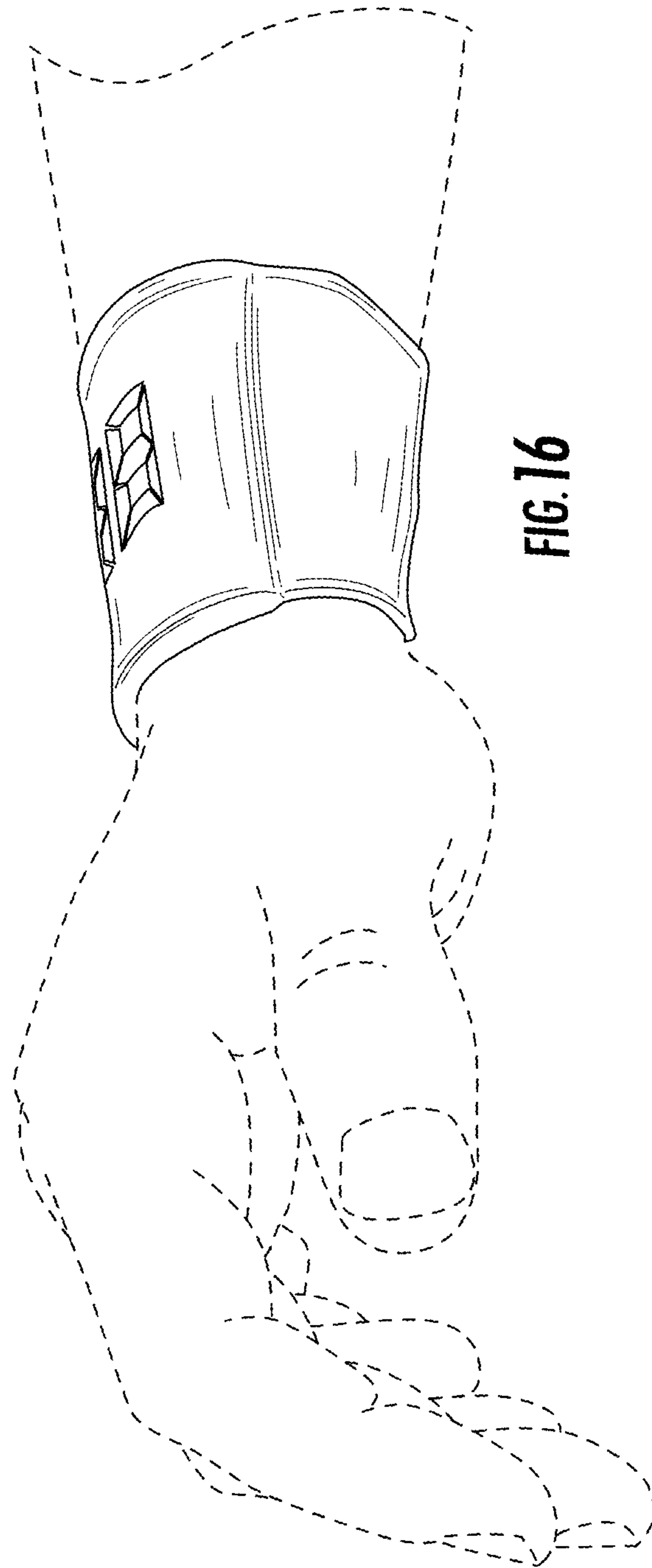

FIG. 16