



US00D773140S

(12) **United States Design Patent Grant** (10) **Patent No.:** **US D773,140 S**  
(45) **Date of Patent:** **\*\* Nov. 29, 2016**

(54) **LAUNDRY BAG**  
(71) Applicant: **The Travel Laundry Company**, Aliso Viejo, CA (US)  
(72) Inventor: **Alyssa Grant**, Aliso Viejo, CA (US)  
(73) Assignee: **The Travel Laundry Company**, Aliso Viejo, CA (US)  
(\*\*) Term: **14 Years**  
(21) Appl. No.: **29/516,163**  
(22) Filed: **Jan. 29, 2015**  
(51) **LOC (10) Cl.** ..... **08-99**  
(52) **U.S. Cl.**  
USPC ..... **D32/36**  
(58) **Field of Classification Search**  
USPC ..... D32/36, 37, 35; D3/216, 215, 318, 319, D3/327, 383, 303; 383/38, 39, 40, 100, 383/103; 206/315.1, 305.3  
CPC ..... B65D 3/00; A63B 55/00; A63B 55/40  
See application file for complete search history.

(56) **References Cited**  
**U.S. PATENT DOCUMENTS**  
2,078,438 A \* 4/1937 Baxter ..... D06F 95/002  
248/100

(Continued)

**OTHER PUBLICATIONS**

Bumkins Laundry Bag, <https://web.archive.org/web/20131026185034/http://www.amazon.com/Bumkins-Laundry-Bag-Blue-Cat/dp/B00A65YM4Y>, apparently available in Oct. 2013, in 4 pages.  
(Continued)

*Primary Examiner* — Susan Bennett Hattan  
*Assistant Examiner* — Rebecca Tshaye  
(74) *Attorney, Agent, or Firm* — Knobbe, Martens, Olson & Bear, LLP

(57) **CLAIM**  
The ornamental design for a laundry bag, as shown and described.

**DESCRIPTION**

FIG. 1 is a top, front, left-side perspective view of a first embodiment of a laundry bag embodying my design;  
FIG. 2 is a front elevation view thereof;

FIG. 3 is a rear elevation view thereof;  
FIG. 4 is a right-side elevation view thereof;  
FIG. 5 is a left-side elevation view thereof;  
FIG. 6 is a top plan view thereof;  
FIG. 7 is a bottom plan view thereof; and  
FIG. 8 is a top, front, left-side perspective view thereof, with the embodiment illustrated in a hanging and open state.  
FIG. 9 a top, front, left-side perspective view of a second embodiment of a laundry bag embodying my design;  
FIG. 10 is a front elevation view thereof;  
FIG. 11 is a rear elevation view thereof;  
FIG. 12 is a right-side elevation view thereof;  
FIG. 13 is a left-side elevation view thereof;  
FIG. 14 is a top plan view thereof;  
FIG. 15 is a bottom plan view thereof; and  
FIG. 16 is a top, front, left-side perspective view thereof, with the embodiment illustrated in a hanging and open state.  
FIG. 17 is a top, front, left-side perspective view of a third embodiment of a laundry bag embodying my design;  
FIG. 18 is a front elevation view thereof;  
FIG. 19 is a rear elevation view thereof;  
FIG. 20 is a right-side elevation view thereof;  
FIG. 21 is a left-side elevation view thereof;  
FIG. 22 is a top plan view thereof;  
FIG. 23 is a bottom plan view thereof; and  
FIG. 24 is a top, front, left-side perspective view thereof, with the embodiment illustrated in a hanging and open state.  
FIG. 25 is a top, front, left-side perspective view of a fourth embodiment of a laundry bag embodying my design;  
FIG. 26 is a front elevation view thereof;  
FIG. 27 is a rear elevation view thereof;  
FIG. 28 is a right-side elevation view thereof;  
FIG. 29 is a left-side elevation view thereof;  
FIG. 30 is a top plan view thereof;  
FIG. 31 is a bottom plan view thereof; and,  
FIG. 32 is a top, front, left-side perspective view thereof, with the embodiment illustrated in a hanging and open state.  
Broken lines illustrate features and environment that form no part of the claimed design. The evenly spaced long dash short dash lines illustrate stitching that forms no part of the claimed design. Cross-hatching illustrates representative and non-limiting surface shading. In the third and fourth embodiments, different cross-hatching is used to indicate that the inside and outside surfaces of the laundry bag are different materials, different colors, or are otherwise ornamentally distinct from each other.

**1 Claim, 24 Drawing Sheets**

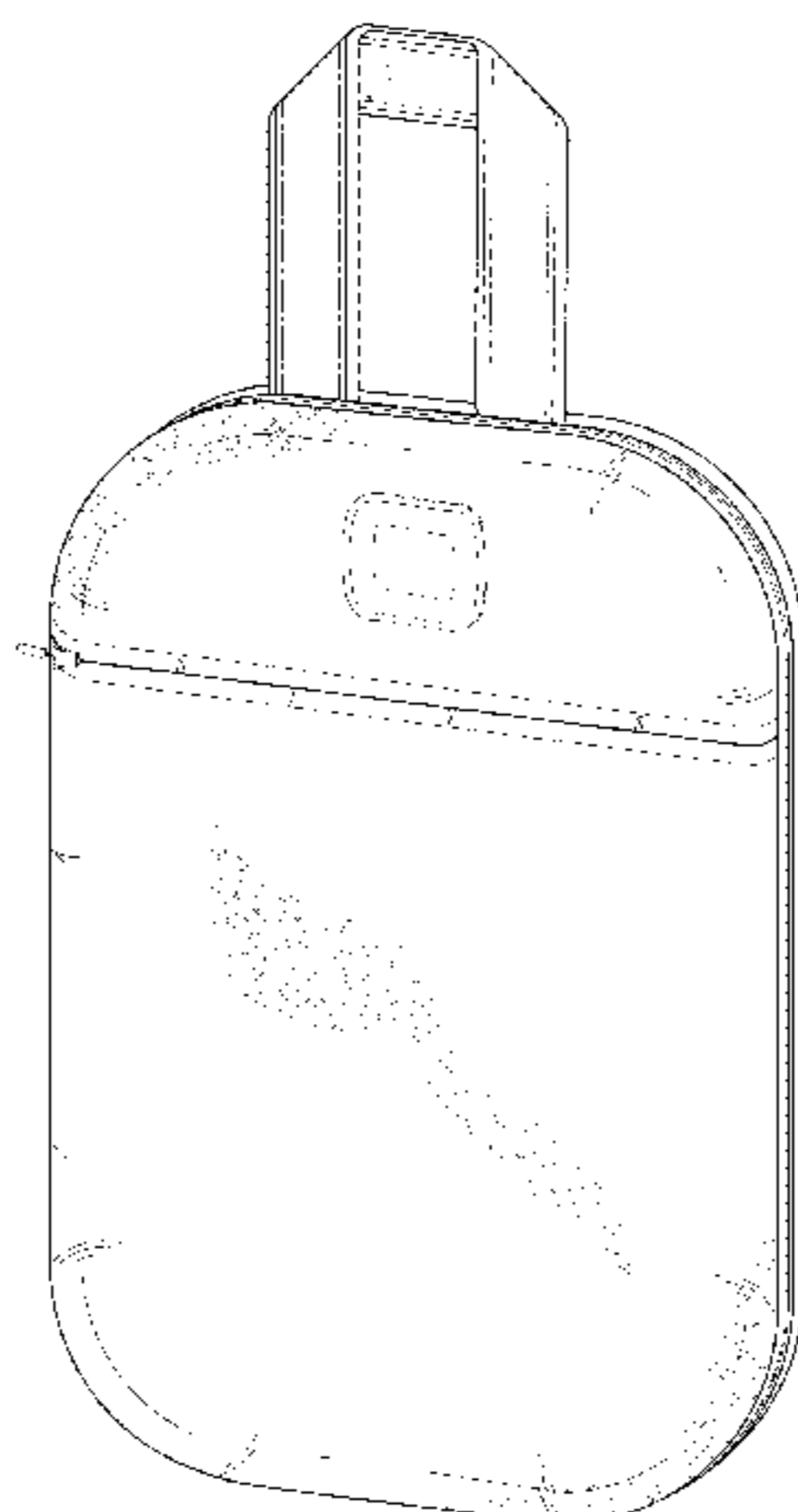

(56)

References Cited

U.S. PATENT DOCUMENTS

2,761,480 A 9/1956 Tames  
2,815,785 A 12/1957 Vail  
3,632,039 A 1/1972 Gayle  
3,943,988 A 3/1976 Consorti  
D247,340 S \* 2/1978 Benstock ..... D3/303  
4,403,636 A 9/1983 Lopez  
4,630,312 A 12/1986 Milstein  
D294,757 S \* 3/1988 Kahane ..... D3/244  
4,773,585 A 9/1988 Lehrman  
D340,963 S \* 11/1993 Hall ..... D3/254  
D363,370 S \* 10/1995 Hamdan ..... D3/216  
D385,074 S \* 10/1997 Soares ..... D3/246

5,803,605 A 9/1998 Masi  
D410,120 S \* 5/1999 Norman ..... D3/278  
D411,671 S \* 6/1999 Hamblin ..... D32/36  
6,398,410 B1 6/2002 Guerra  
D507,871 S \* 8/2005 DiMarchi ..... D3/215  
8,640,506 B1 2/2014 Grear et al.

OTHER PUBLICATIONS

F1 Go Clean Laundry, <https://web.archive.org/web/20130310202717/http://www.flight001.com/fl-go-clean-laundry.html>, apparently available in Mar. 2013, in 2 pages.

\* cited by examiner

FIG. 1

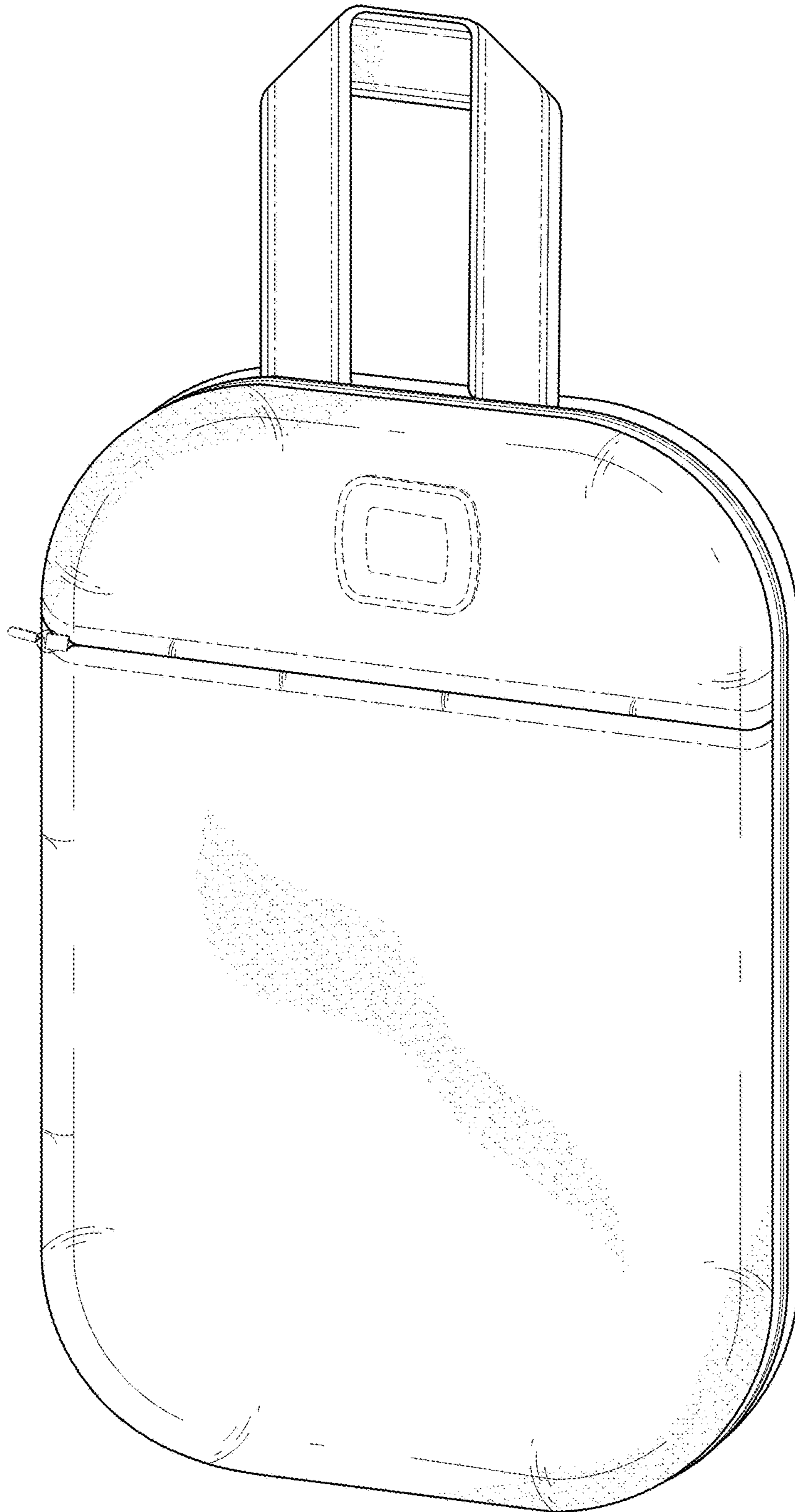

FIG. 2

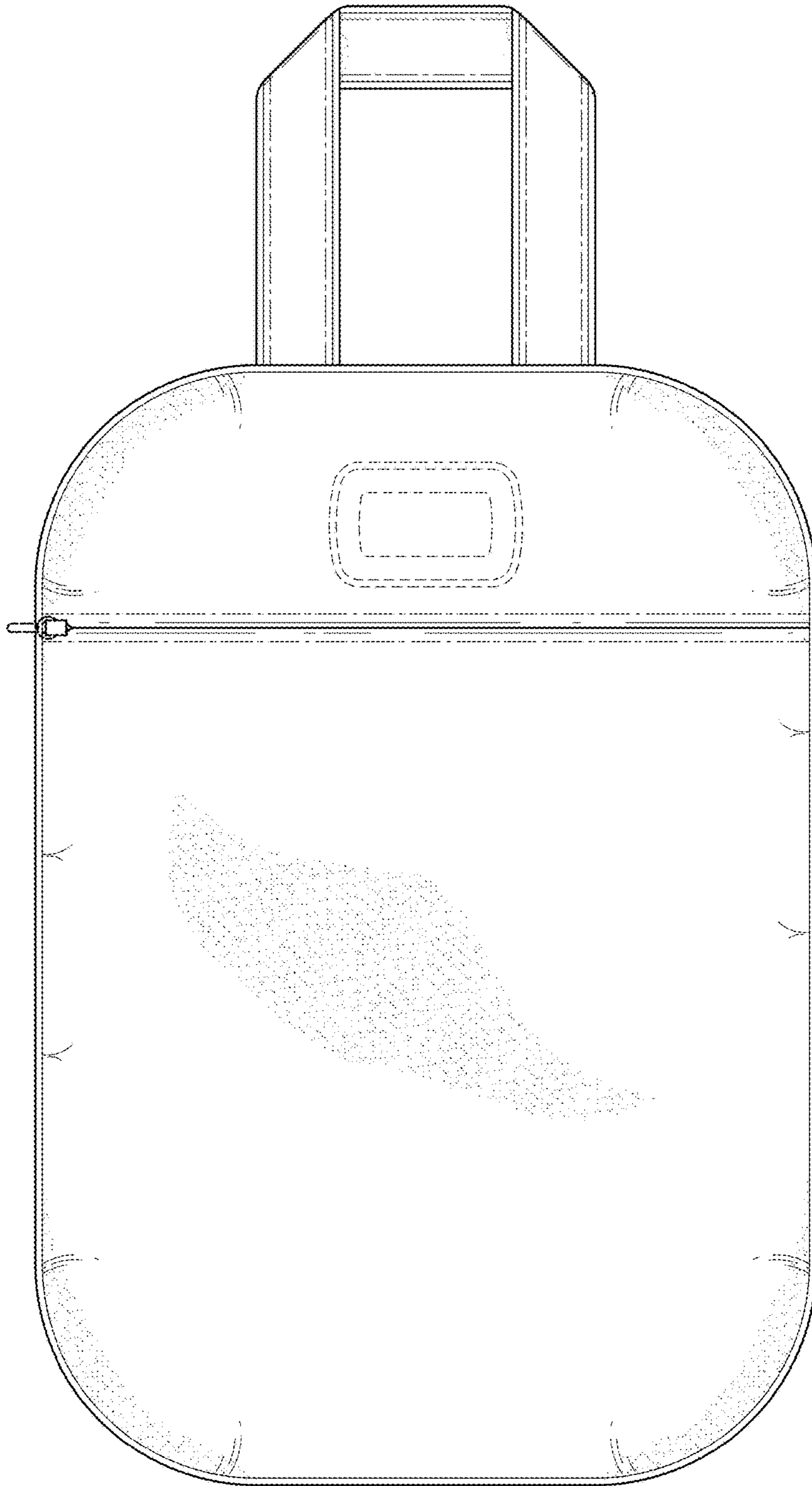
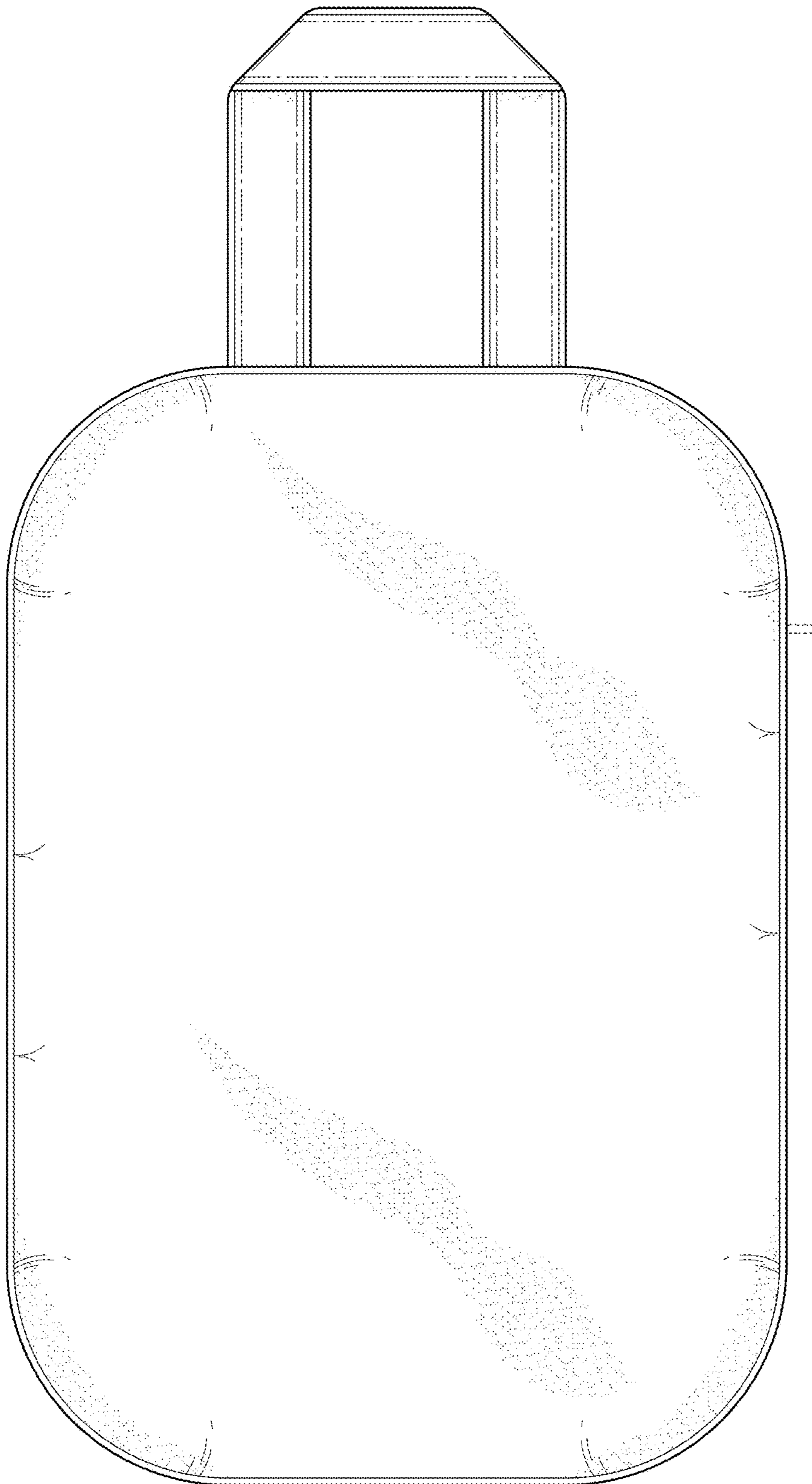

FIG. 3



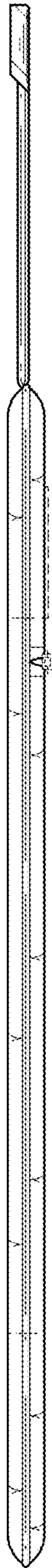

FIG. 4

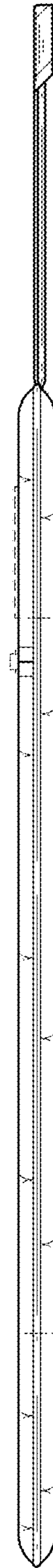

FIG. 5

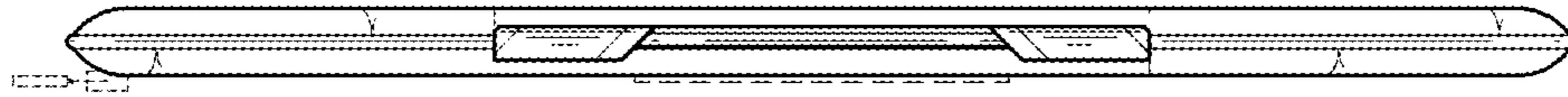

FIG. 6

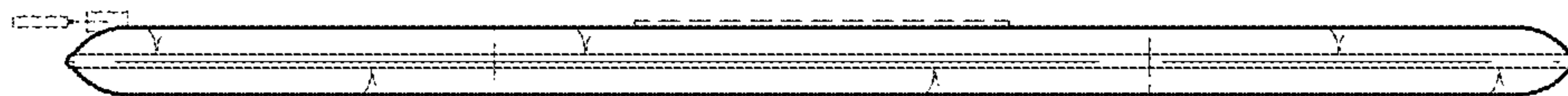

FIG. 7

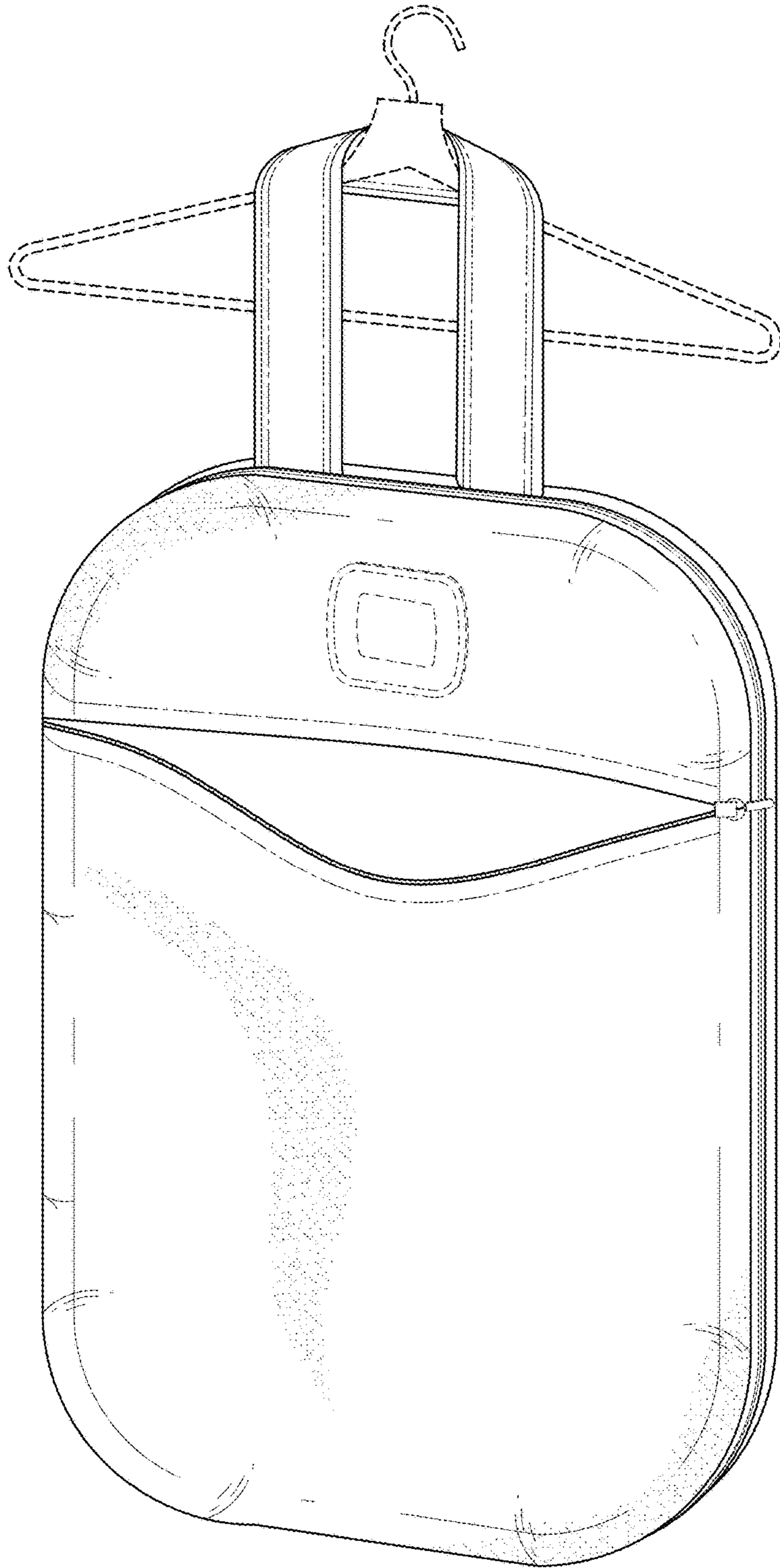

FIG. 8



FIG. 9



FIG. 10



FIG. II



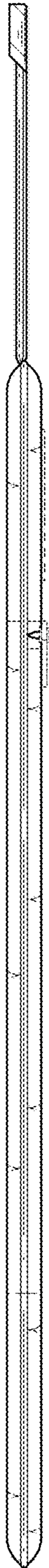

FIG. 12

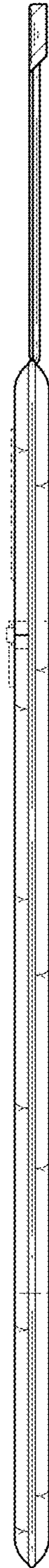

FIG. 13

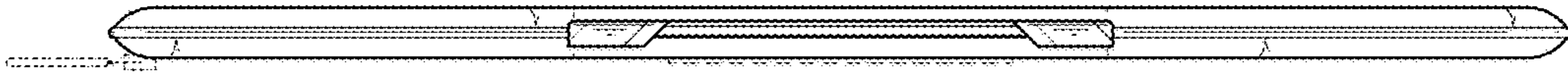

FIG. 14

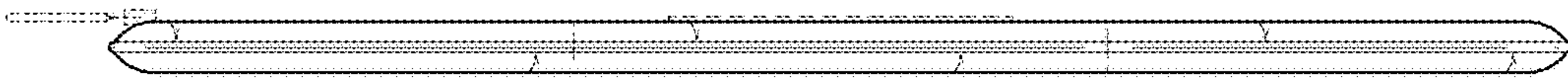

FIG. 15

FIG. 16



FIG. 17

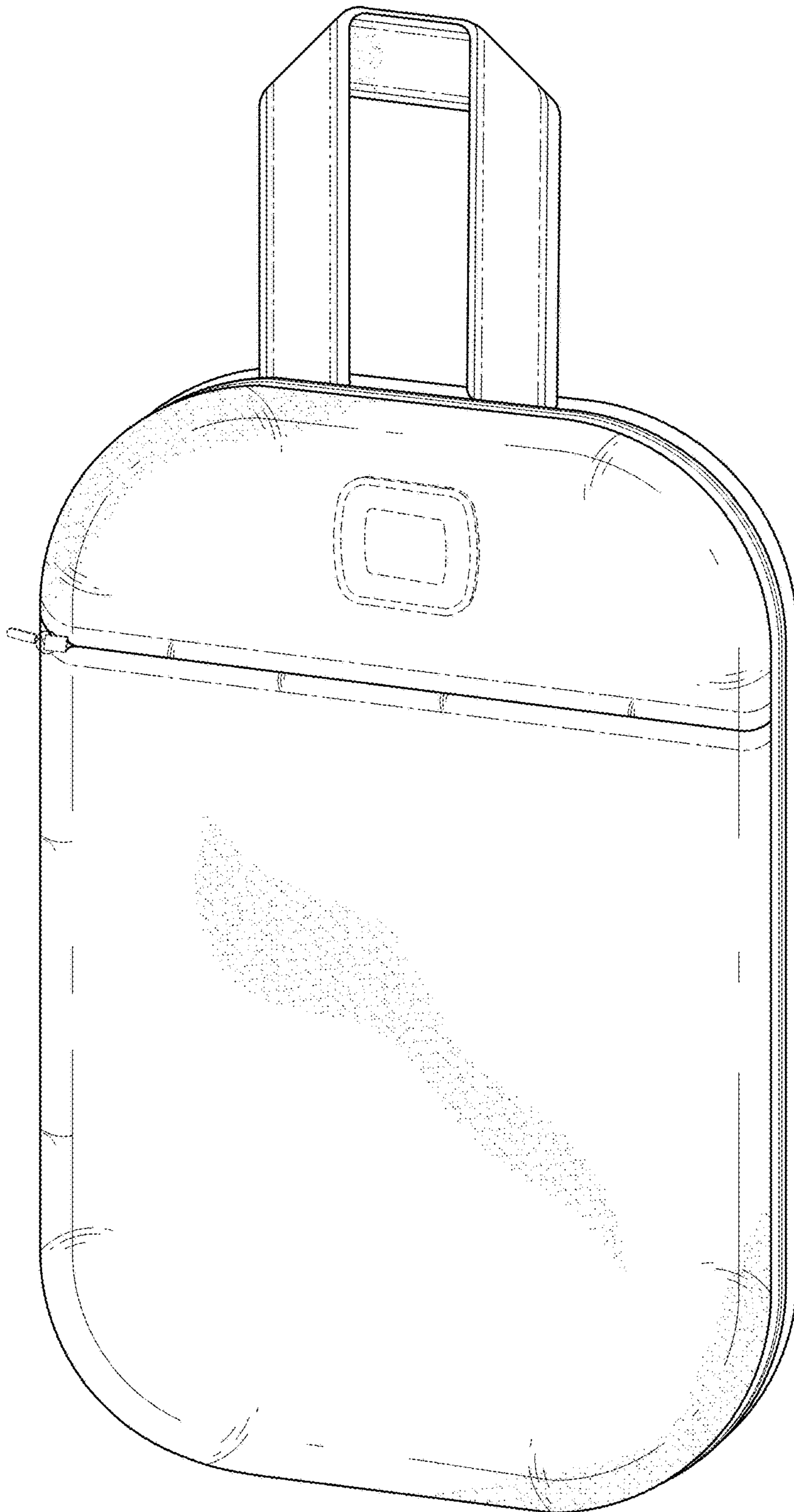

FIG. 18

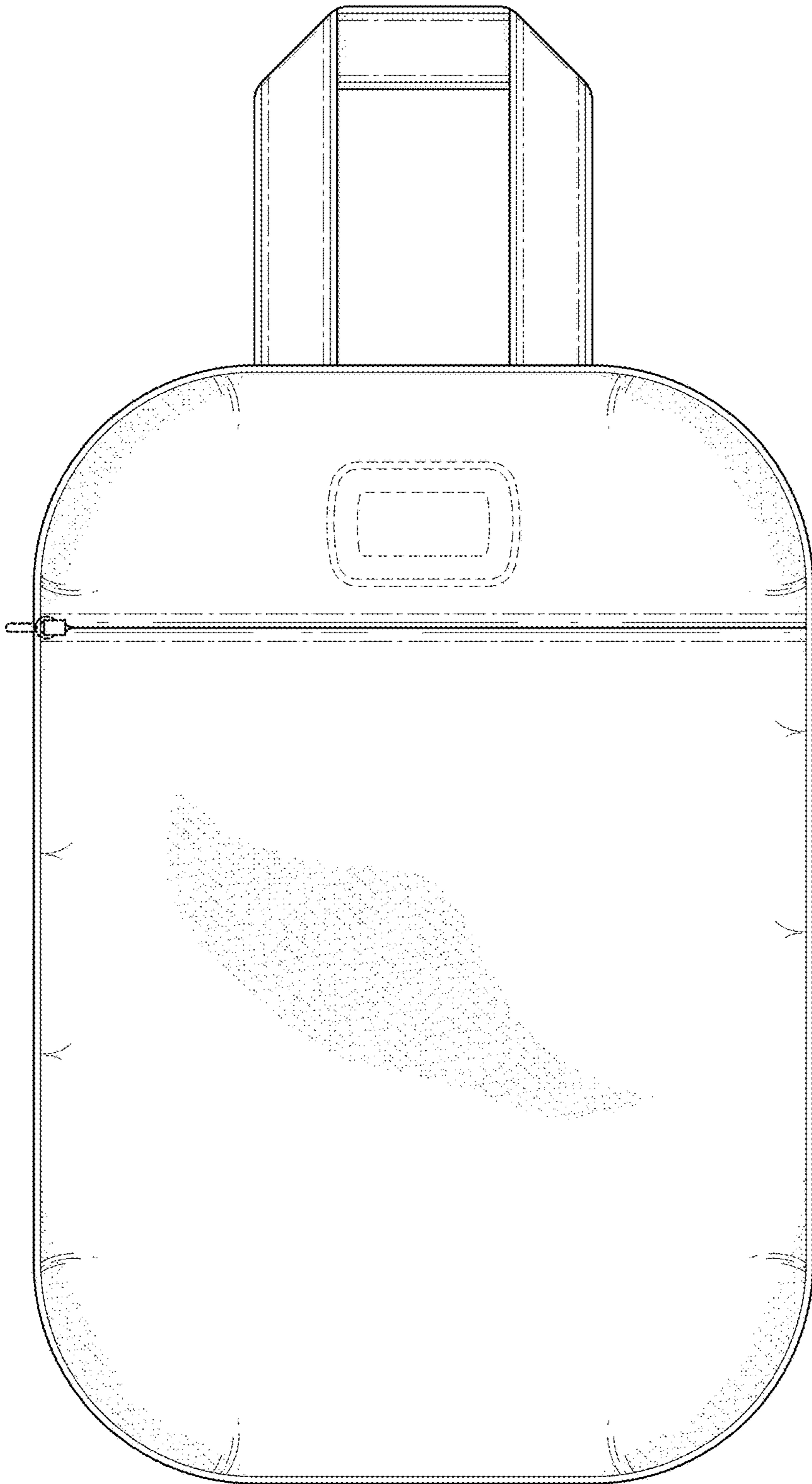
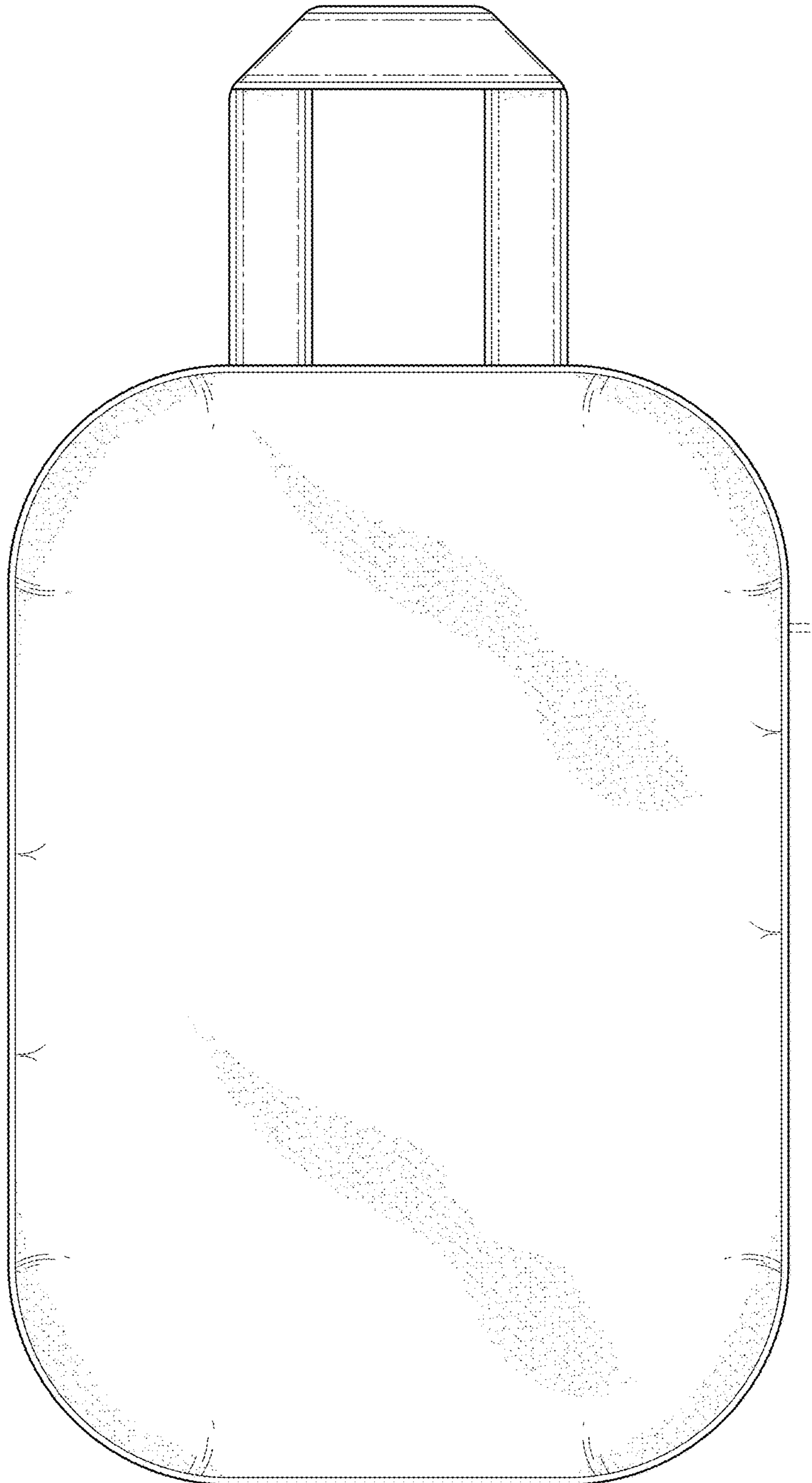



FIG. 19



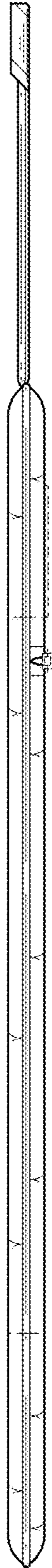

FIG. 20

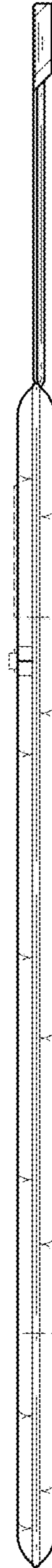

FIG. 21

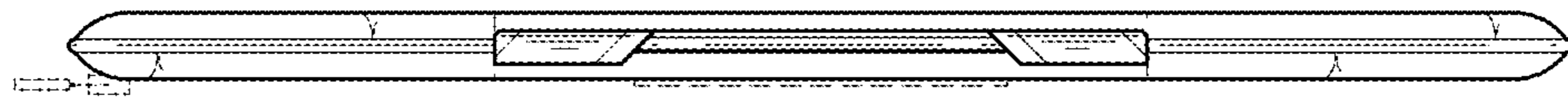

FIG. 22

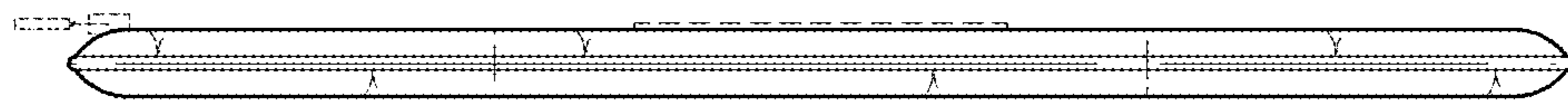

FIG. 23

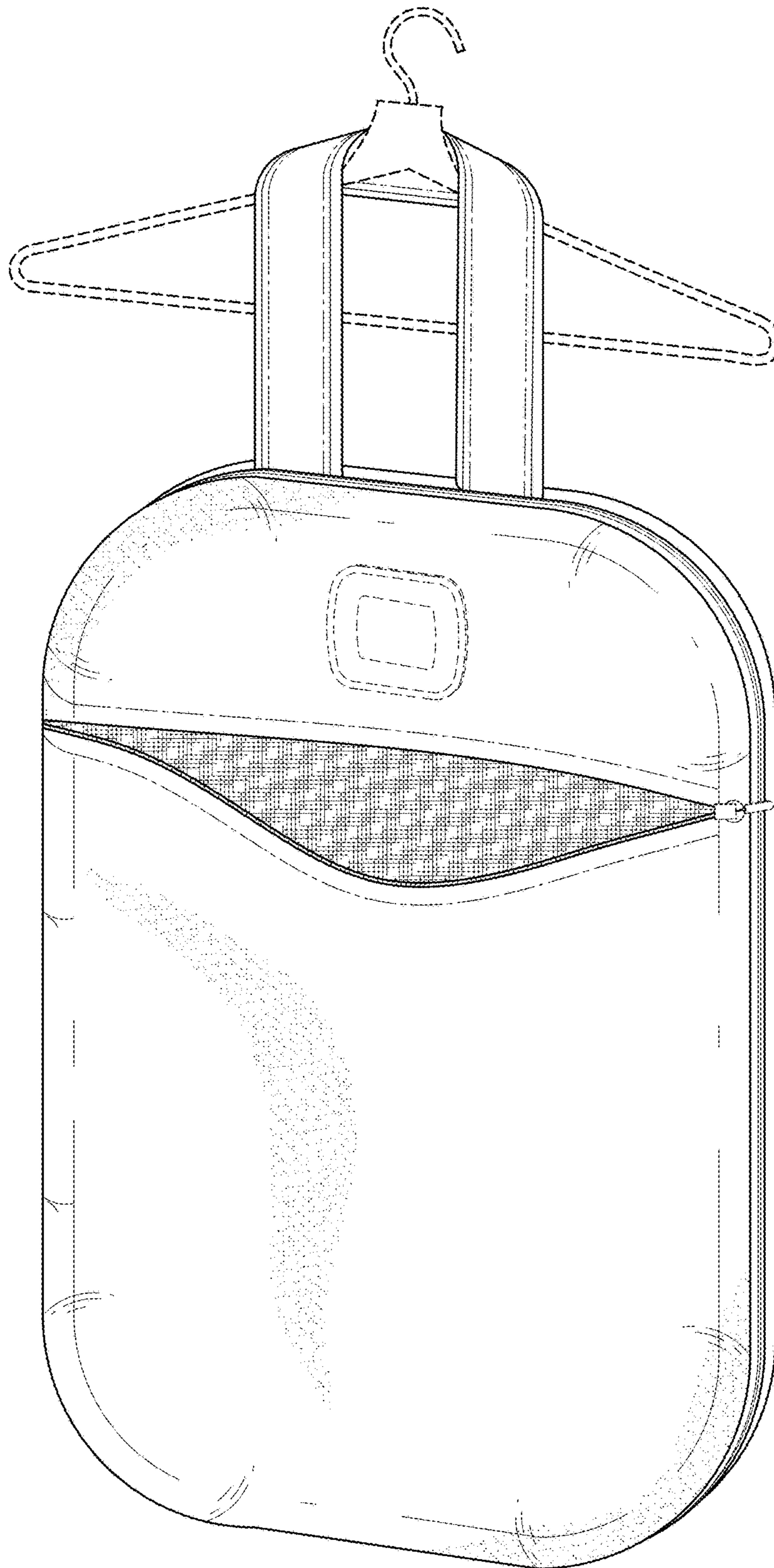

FIG. 24

FIG. 25



FIG. 26



FIG. 27



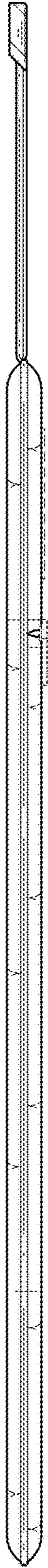

FIG. 28

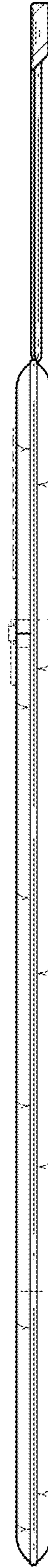

FIG. 29



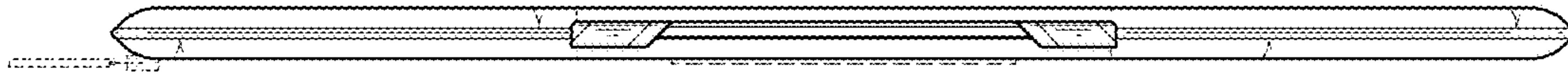

FIG. 30

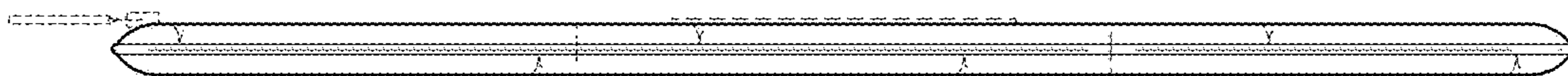

FIG. 31

FIG. 32

