



US00D772958S

(12) **United States Design Patent** (10) **Patent No.:** **US D772,958 S**  
**Lonati et al.** (45) **Date of Patent:** **\*\* Nov. 29, 2016**

(54) **DEVICE FOR FEEDING THREAD TO NEEDLES OF A KNITTING MACHINE**

(71) Applicant: **SANTONI S.P.A.**, Brescia (IT)

(72) Inventors: **Ettore Lonati**, Botticino (IT); **Fausto Lonati**, Brescia (IT)

(73) Assignee: **Santoni S.P.A.**, Brescia (IT)

(\*\*) Term: **14 Years**

(21) Appl. No.: **29/496,373**

(22) Filed: **Jul. 11, 2014**

(30) **Foreign Application Priority Data**

Jan. 15, 2014 (IT) ..... BS2014O0002

(51) **LOC (10) Cl.** ..... **15-06**

(52) **U.S. Cl.**  
USPC ..... **D15/78**

(58) **Field of Classification Search**  
USPC ..... D15/66-78  
CPC D04B 13/00; D04B 13/02; D04B 9/00-9/58  
See application file for complete search history.

(56) **References Cited**

**U.S. PATENT DOCUMENTS**

2,153,019	A *	4/1939	Holmes	.....	66/24
D198,581	S *	7/1964	Kamp	.....	D15/66
3,859,822	A *	1/1975	Renda et al.	.....	66/8
3,959,992	A *	6/1976	Eschenbach	.....	66/8
4,033,147	A *	7/1977	King	.....	66/8
D246,244	S *	11/1977	Current et al.	.....	D15/66

D247,900	S *	5/1978	Current	.....	D15/66
4,539,825	A *	9/1985	Colosio	.....	66/24
D311,745	S *	10/1990	Wieland	.....	D15/66
5,761,931	A *	6/1998	Lonati et al.	.....	66/148
6,101,848	A *	8/2000	Wang	.....	66/31
6,223,564	B1 *	5/2001	Lonati et al.	.....	66/8
7,310,976	B1 *	12/2007	Renda	.....	66/125 R
8,245,544	B2 *	8/2012	Lonati et al.	.....	66/31
2010/0192637	A1 *	8/2010	Lonati et al.	.....	66/19

\* cited by examiner

*Primary Examiner* — Mitchell Siegel

(74) *Attorney, Agent, or Firm* — Fish & Richardson P.C.

(57) **CLAIM**

The ornamental design of a device for feeding thread to needles of a knitting machine, substantially as shown and described.

**DESCRIPTION**

FIG. 1 is a perspective view of a device for feeding thread to needles of a knitting machine in accordance with the present design;

FIG. 2 is a top view thereof;

FIG. 3 is a right side view thereof;

FIG. 4 is a bottom view thereof;

FIG. 5 is a left side view thereof;

FIG. 6 is a front side view thereof; and,

FIG. 7 is a rear side view thereof.

Generally, the invention pertains to an ornamental design for an article of manufacture. The article is not limited to the scale shown herein.

The broken line portions of the figures are included to show unclaimed subject matter only and form no part of the claimed design.

**1 Claim, 7 Drawing Sheets**

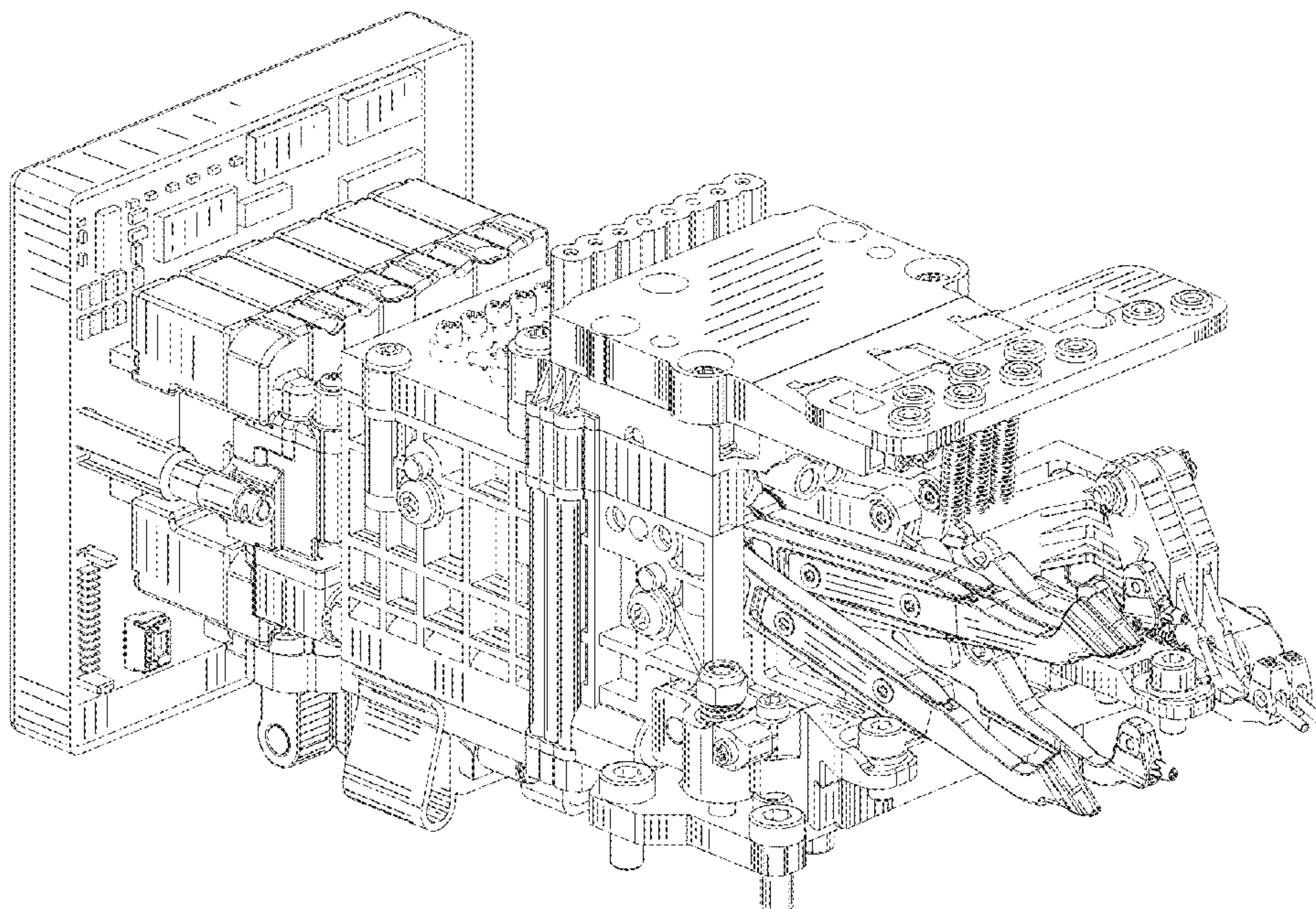

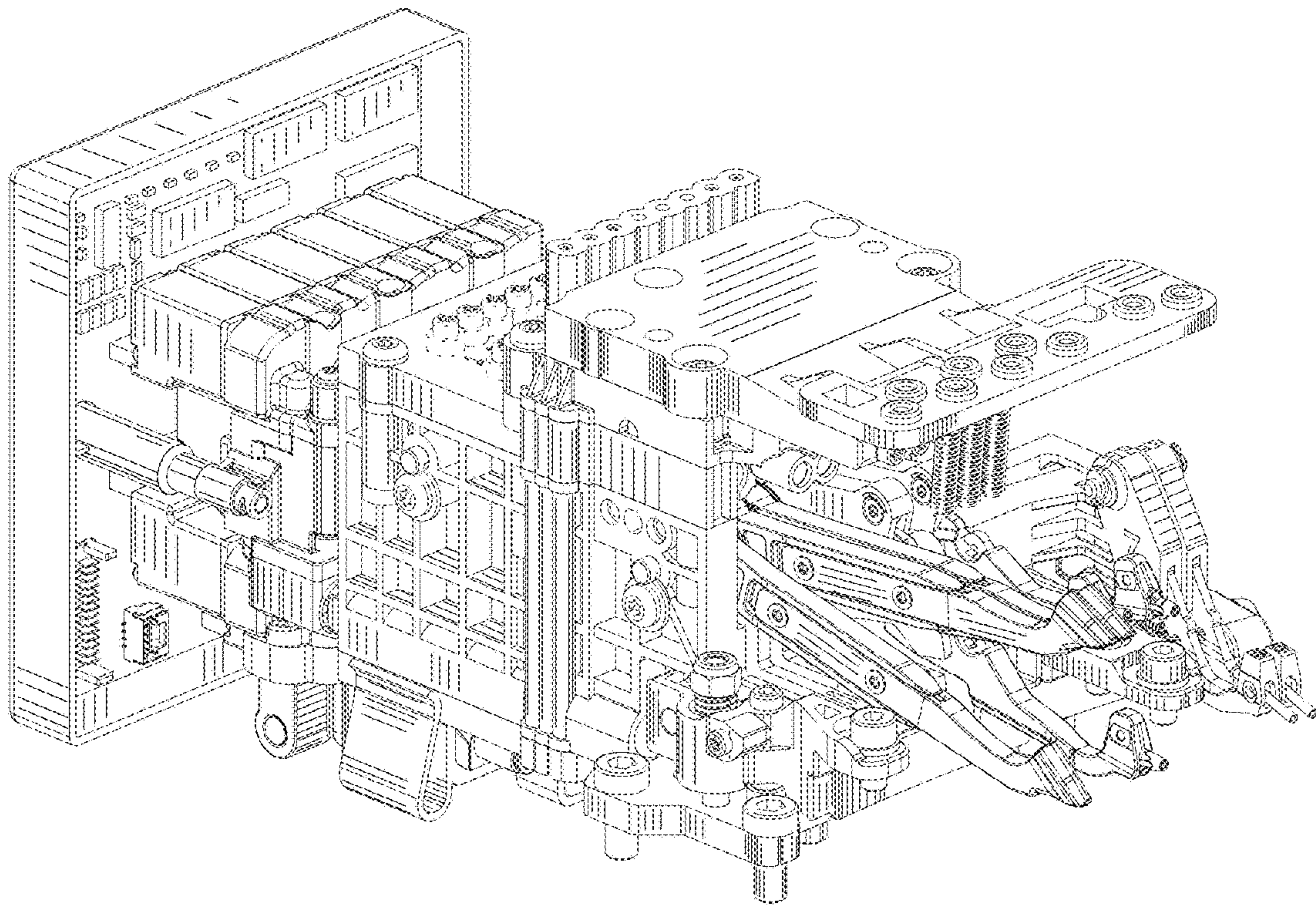

Fig. 1



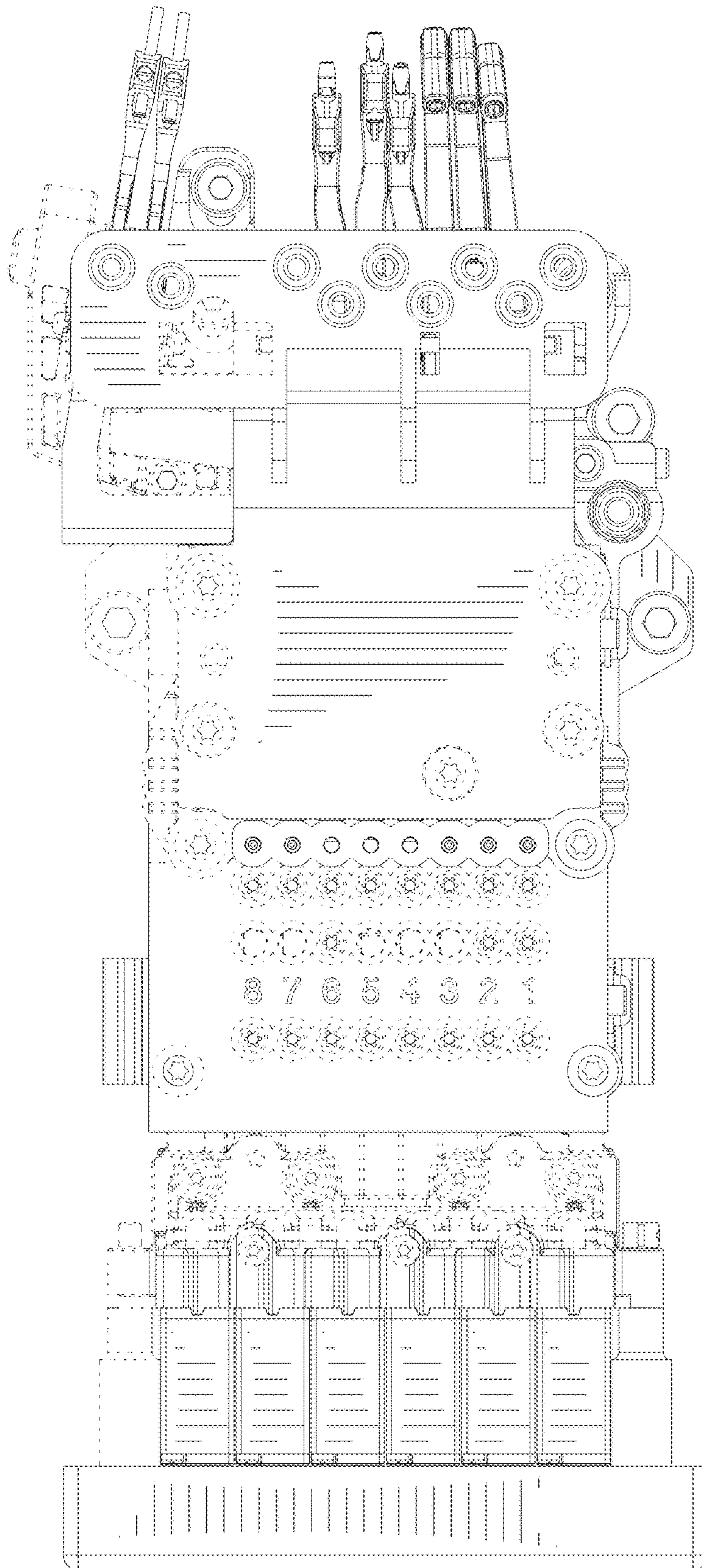

Fig. 2

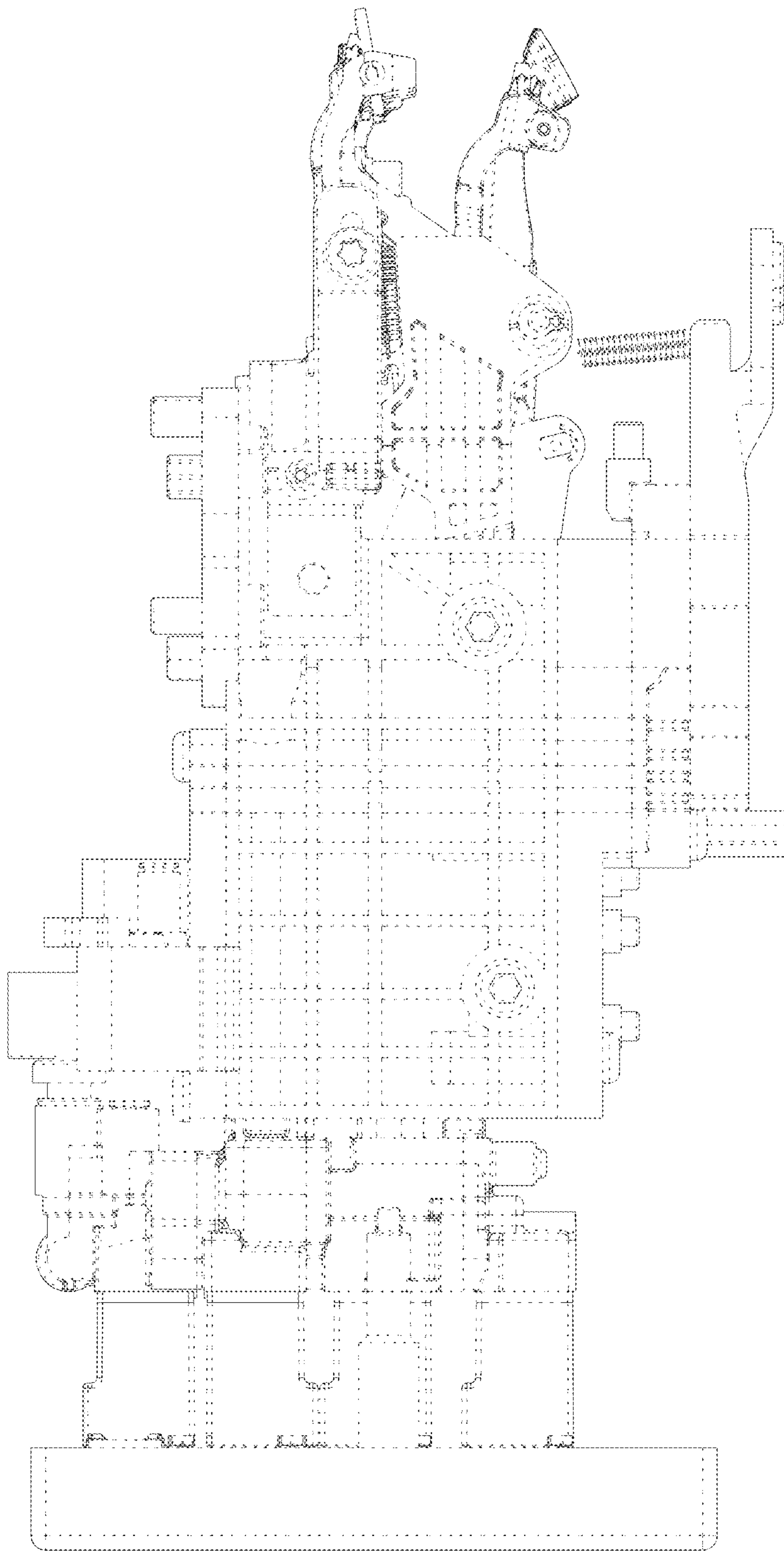

Fig. 3

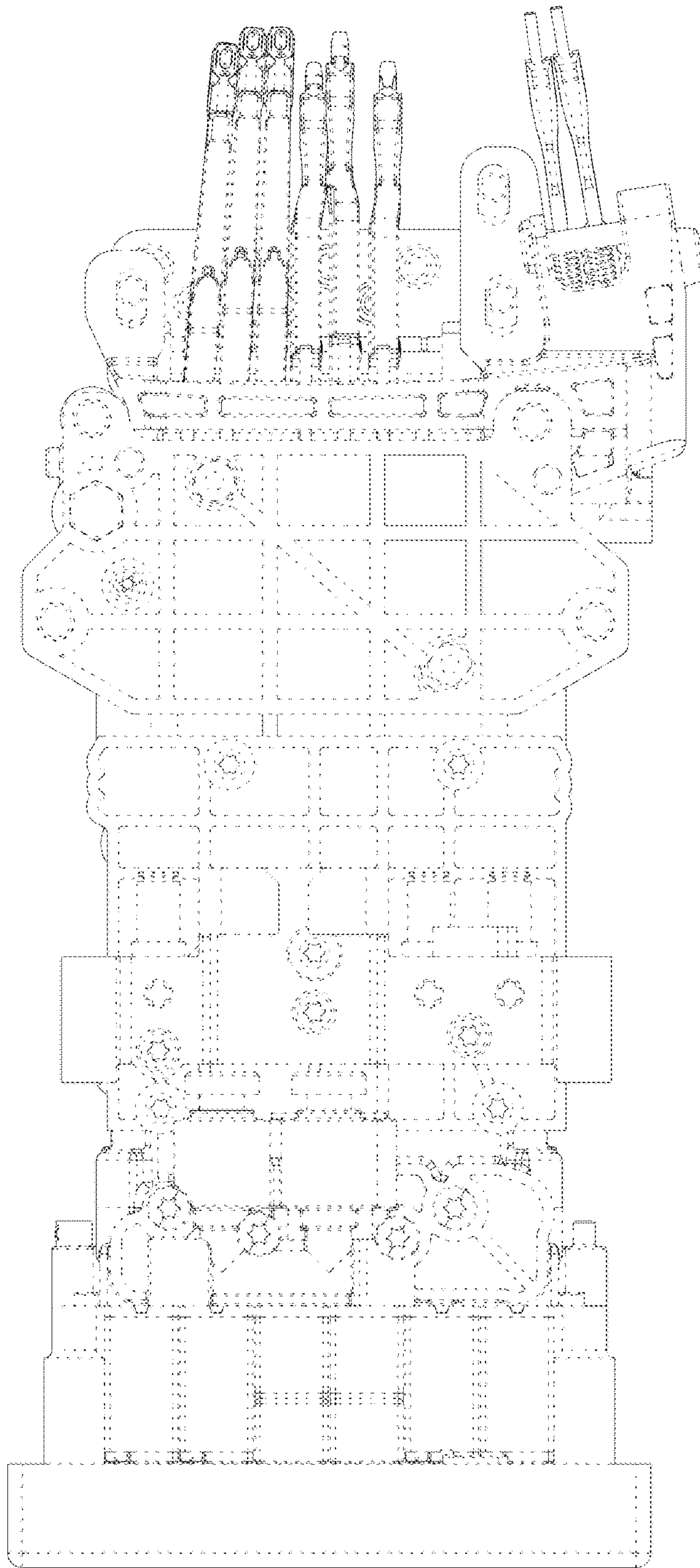

Fig. 4



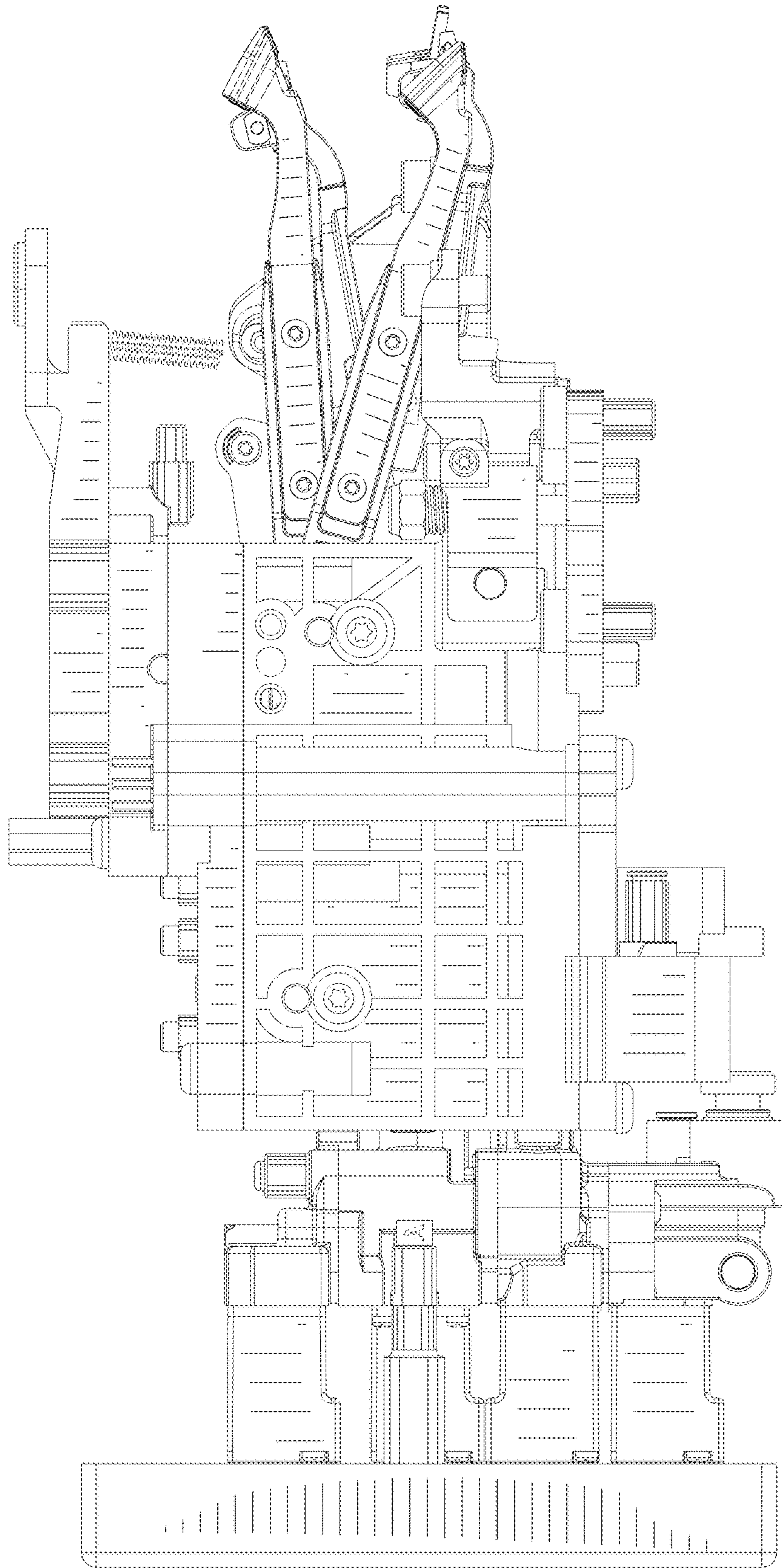

Fig. 5

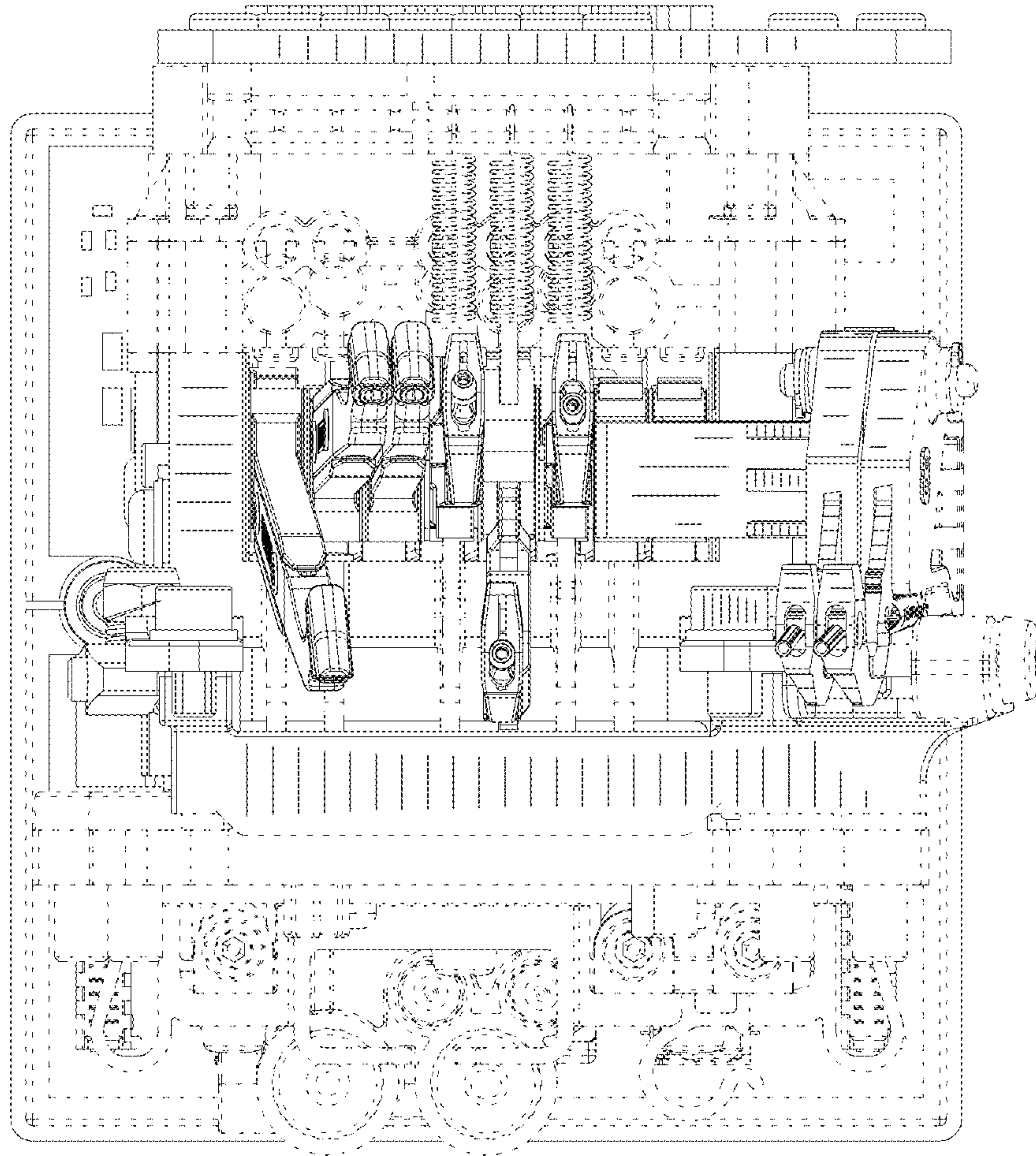

Fig. 6

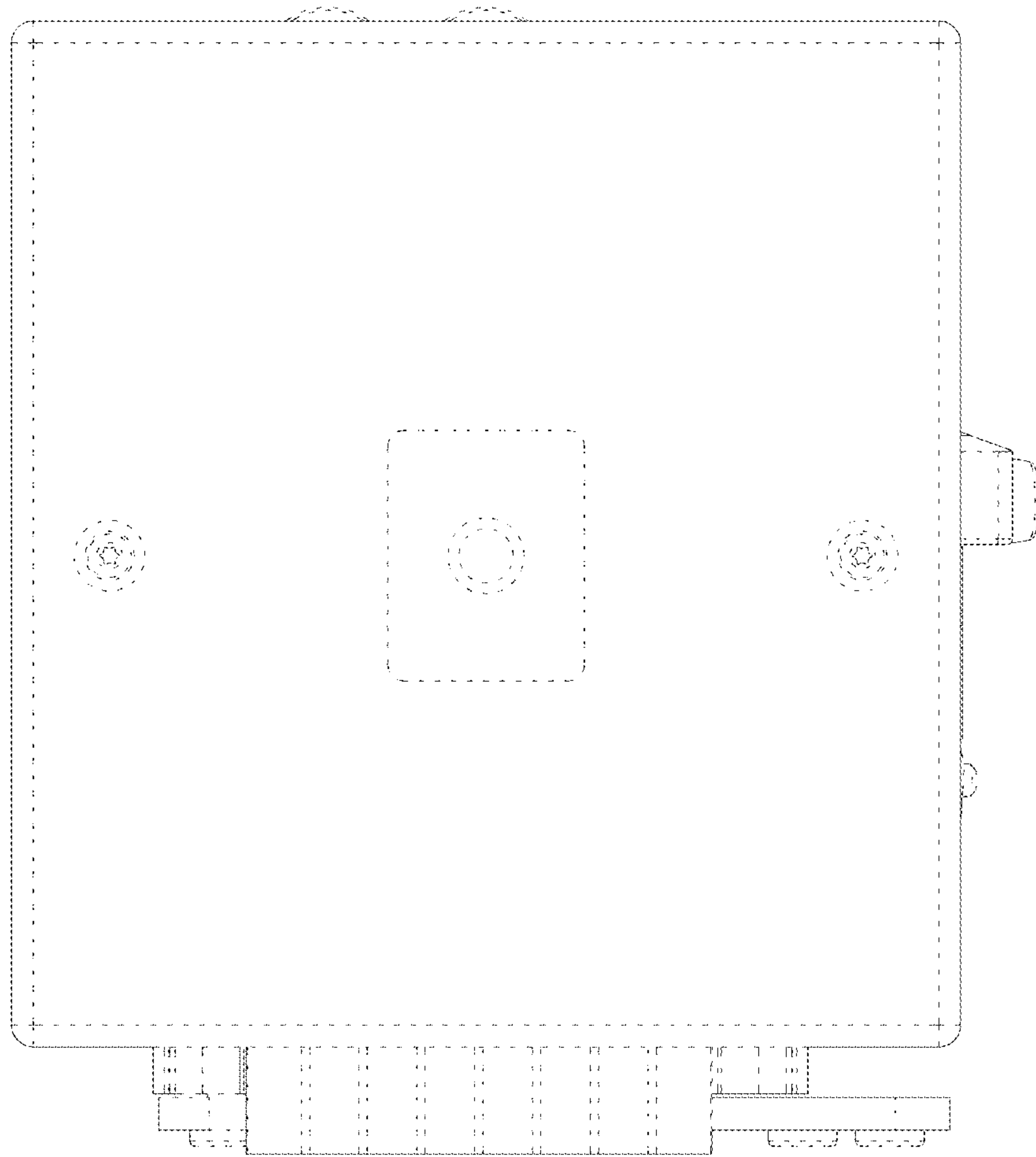

Fig. 7