



US00D772883S

(12) **United States Design Patent**  
**Sun**

(10) **Patent No.:** **US D772,883 S**

(45) **Date of Patent:** **\*\* Nov. 29, 2016**

(54) **SUPPORTER FOR PORTABLE DEVICE**

8,534,635 B2 \* 9/2013 Yang ..... F16M 11/10  
248/454

(71) Applicant: **HON HAI PRECISION INDUSTRY CO., LTD.**, New Taipei (TW)

9,151,439 B2 \* 10/2015 Liang ..... F16M 11/046  
9,207,714 B2 \* 12/2015 Boomhour ..... G06F 1/1632

(72) Inventor: **Lin Sun**, ShenZhen (CN)

\* cited by examiner

(73) Assignee: **HON HAI PRECISION INDUSTRY CO., LTD.**, New Taipei (TW)

*Primary Examiner* — Holly Baynham

(74) *Attorney, Agent, or Firm* — Zhigang Ma

(\*\*) Term: **14 Years**

(21) Appl. No.: **29/516,510**

(22) Filed: **Feb. 3, 2015**

(57) **CLAIM**

I claim the ornamental design for a supporter for portable device, as shown and described.

(30) **Foreign Application Priority Data**

Dec. 18, 2014 (CN) ..... 2014 3 0536473

**DESCRIPTION**

(51) **LOC (10) Cl.** ..... **08-07**

(52) **U.S. Cl.**  
USPC ..... **D14/447**

(58) **Field of Classification Search**  
USPC ..... D14/447  
CPC ..... G06F 1/16; A47G 1/24; A47F 7/00;  
F16M 11/38  
See application file for complete search history.

FIG. 1 is a perspective view of a supporter for portable device showing my new design;  
FIG. 2 is a front elevational view thereof;  
FIG. 3 is a rear elevational view thereof;  
FIG. 4 is a left side elevational view thereof;  
FIG. 5 is a right side elevational view thereof;  
FIG. 6 is a top plan view thereof;  
FIG. 7 is a bottom plan view thereof; and,  
FIG. 8 is a reference perspective view showing the supporter for portable device in use.

The broken lines are for illustrating unclaimed portions of the supporter for portable device; the broken lines form no part of the claimed design.

(56) **References Cited**

**U.S. PATENT DOCUMENTS**

6,843,380 B1 \* 1/2005 Fickett ..... B62H 3/12  
211/17  
D689,500 S \* 9/2013 Faulk ..... D14/447

**1 Claim, 8 Drawing Sheets**

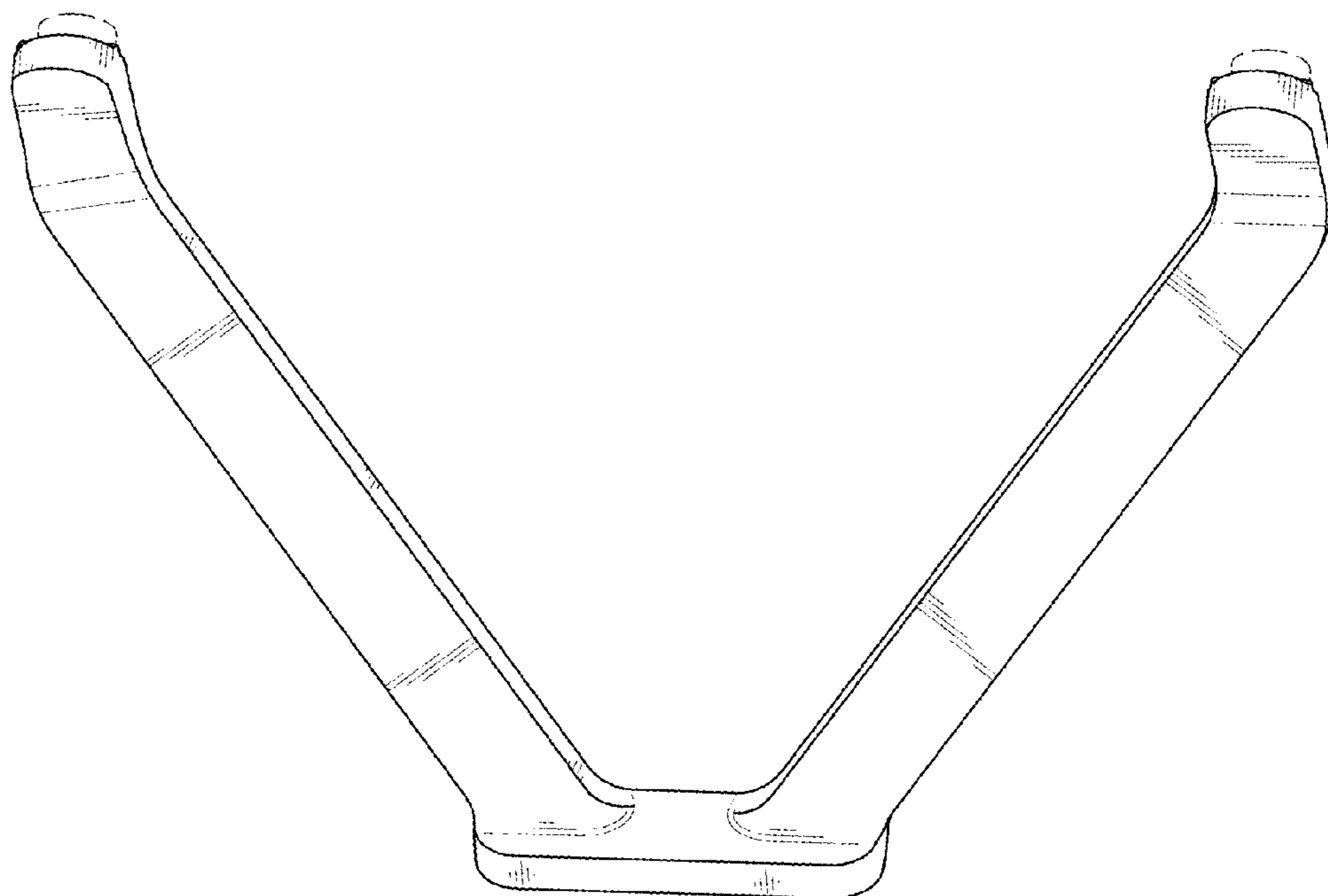

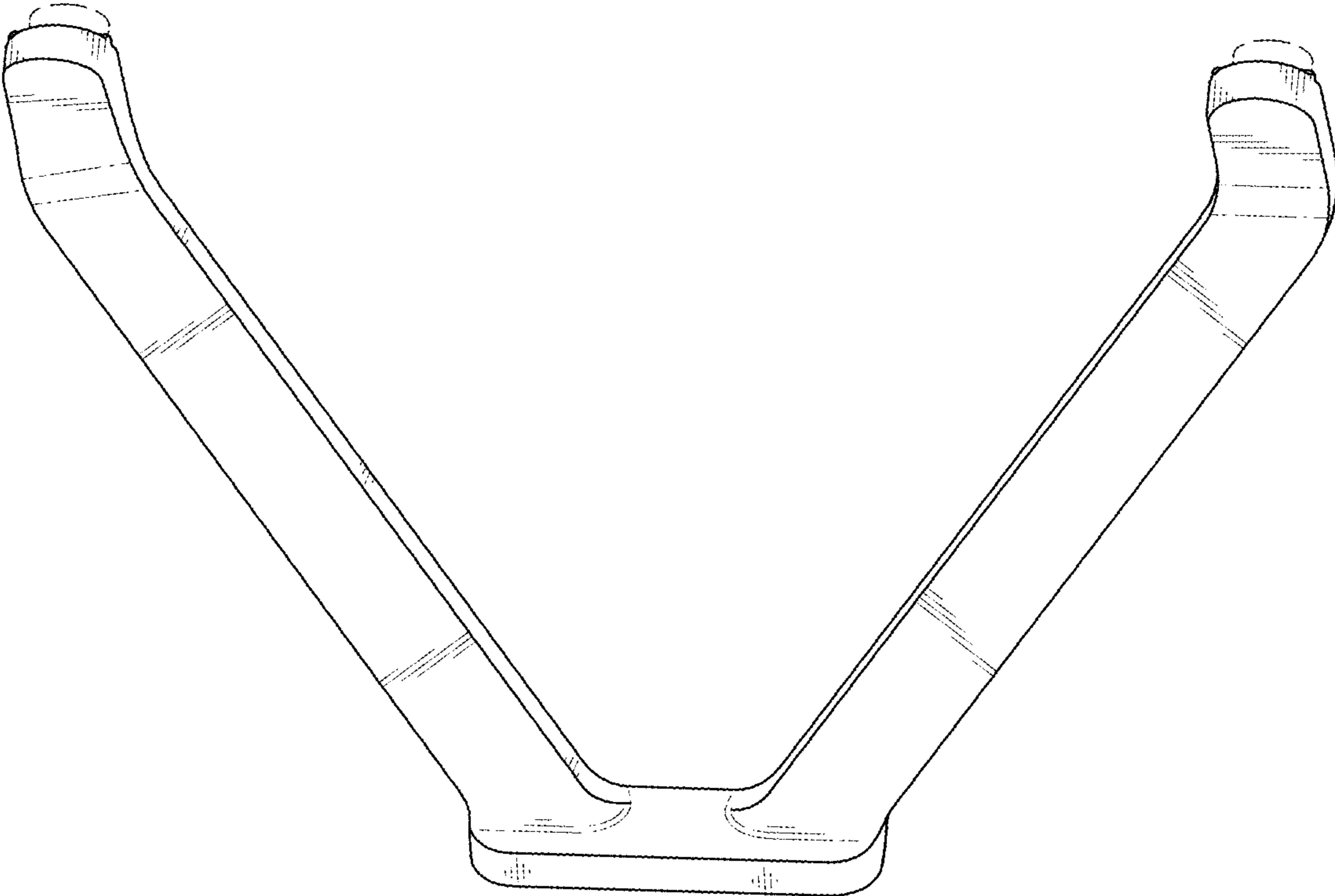

FIG. 1

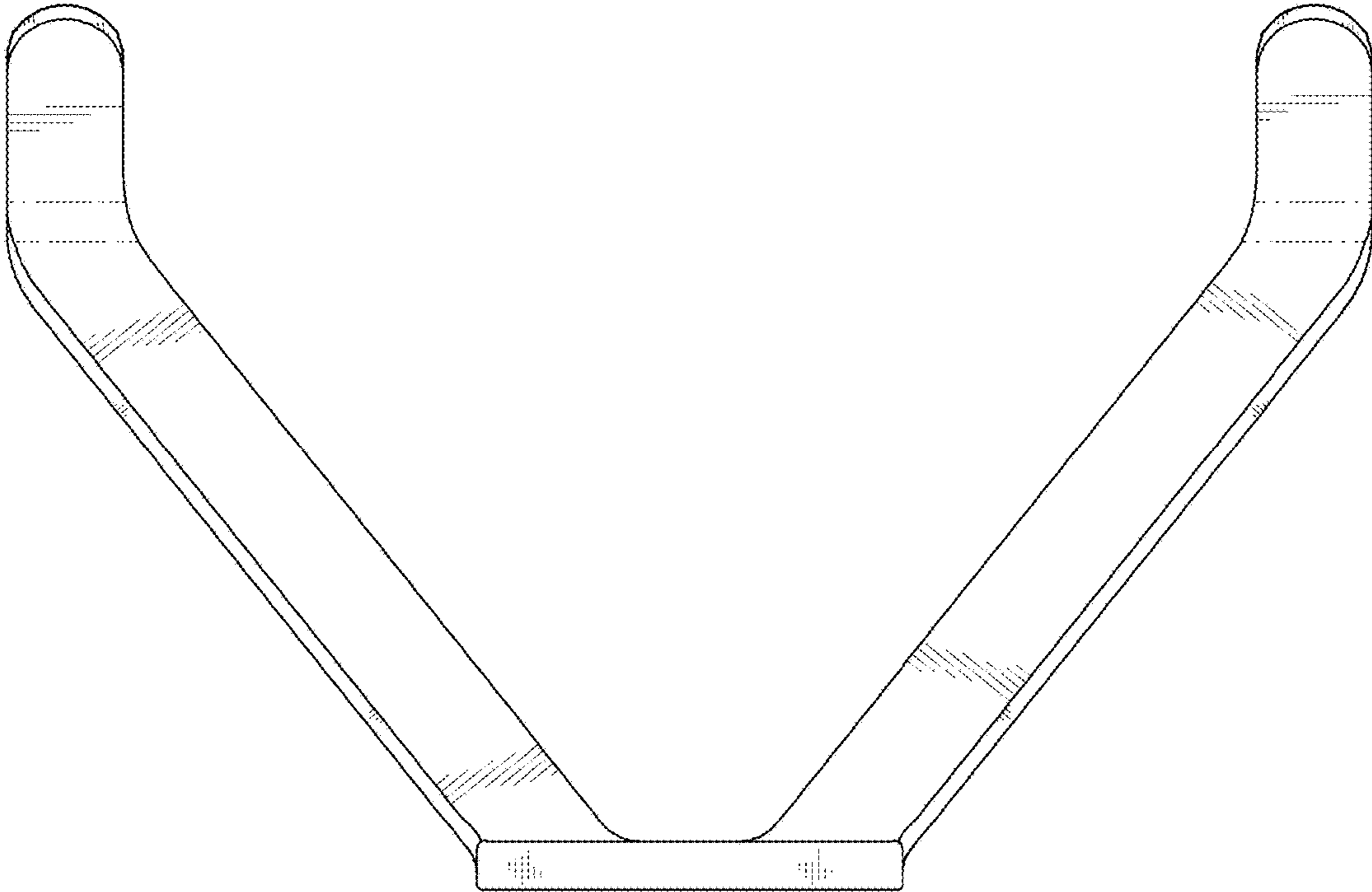

FIG. 2

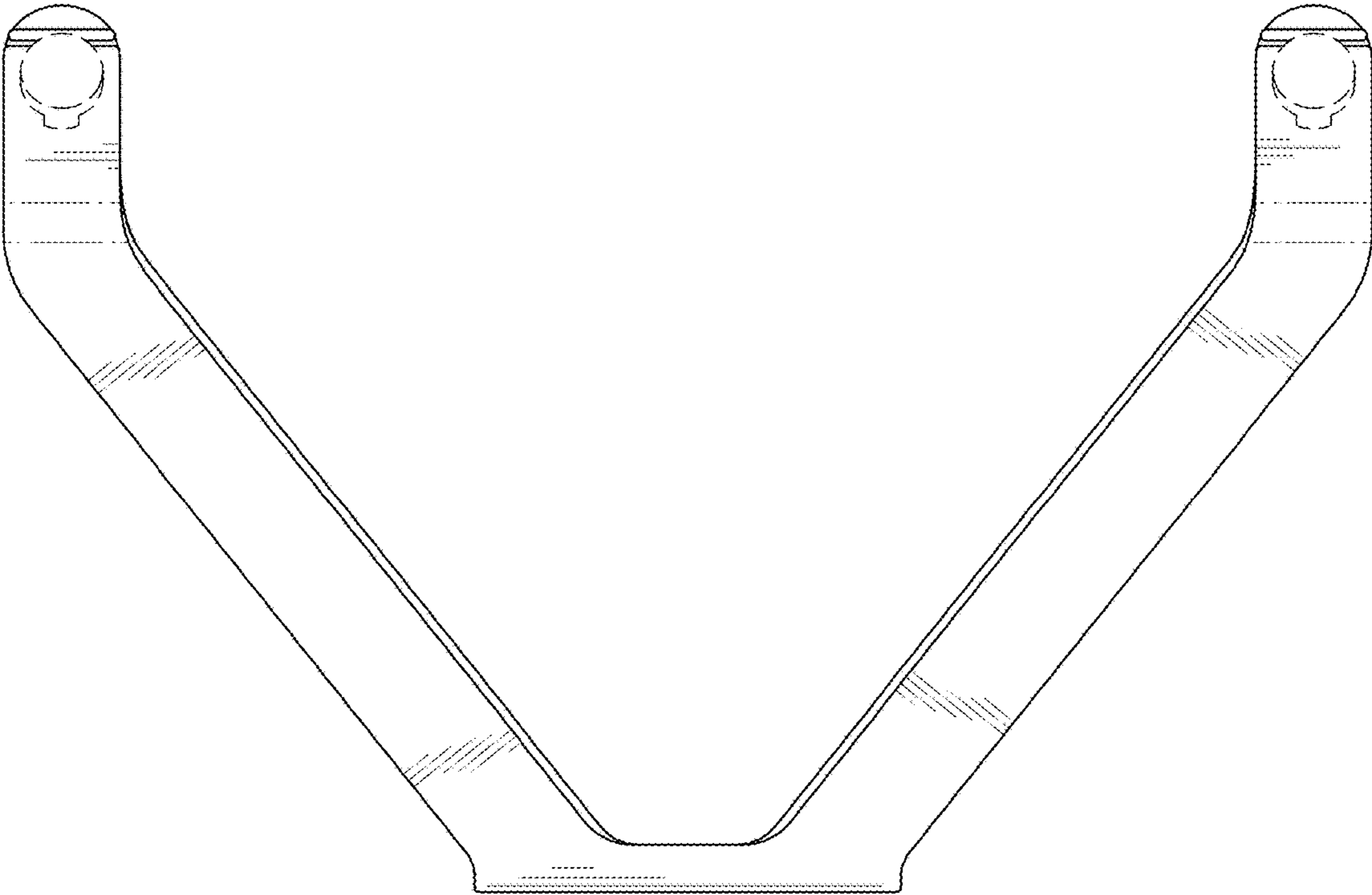

FIG. 3

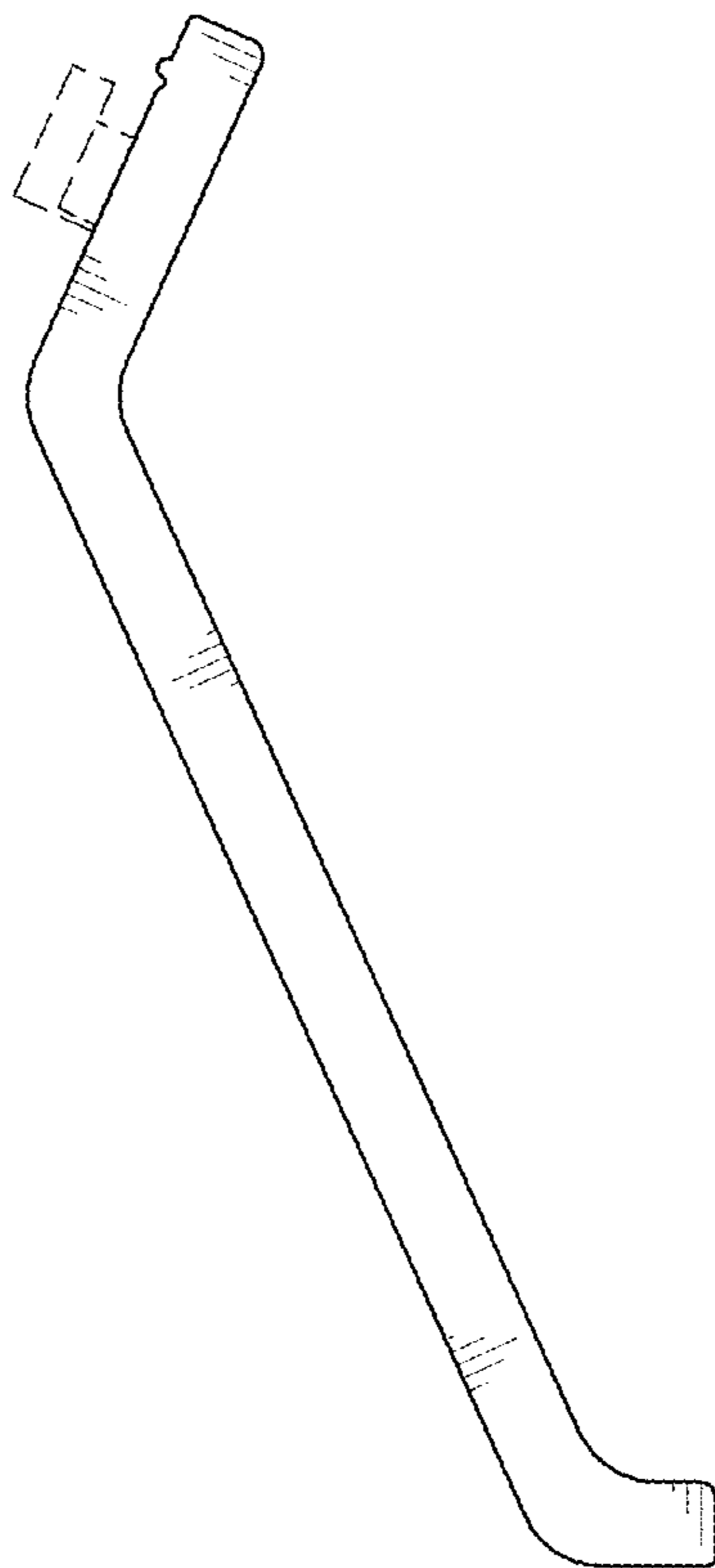

FIG. 4

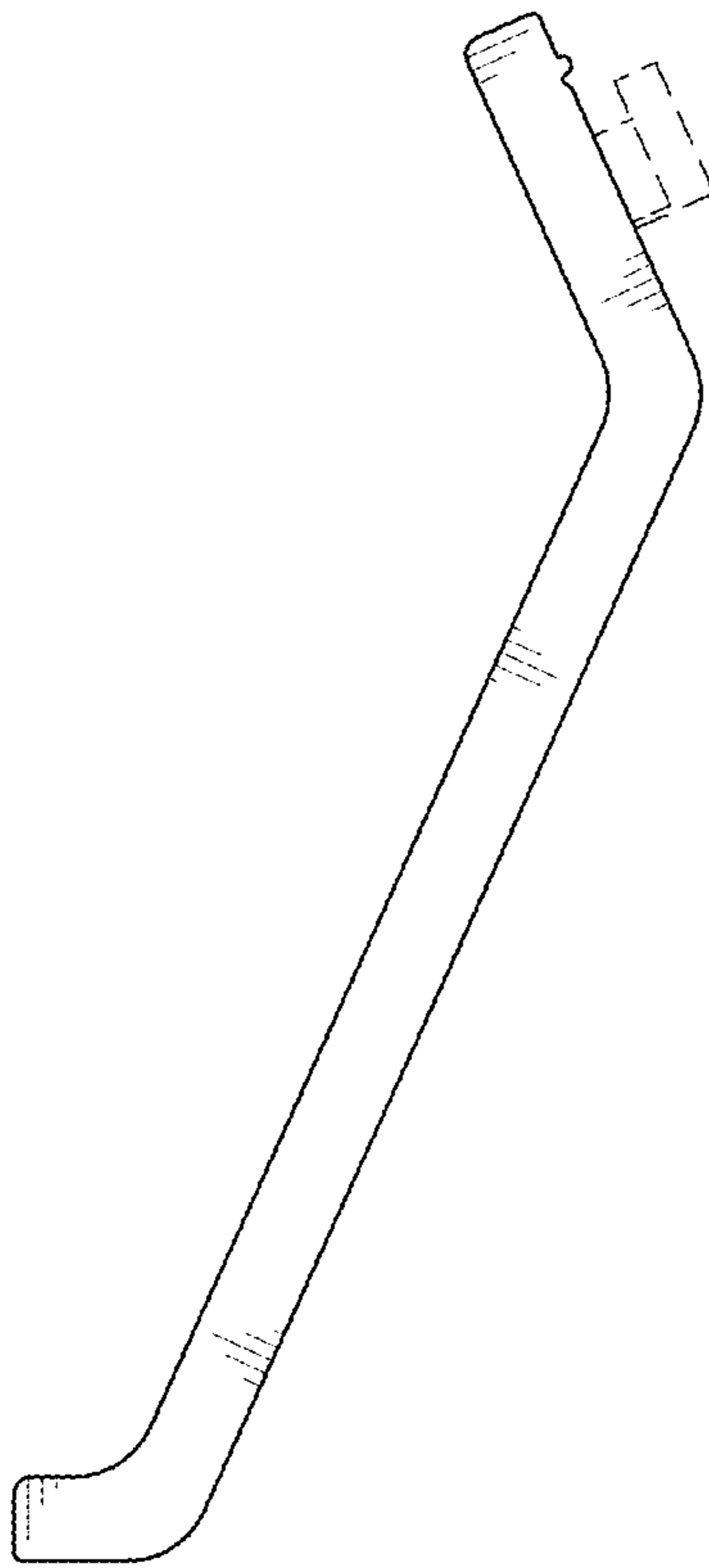

FIG. 5

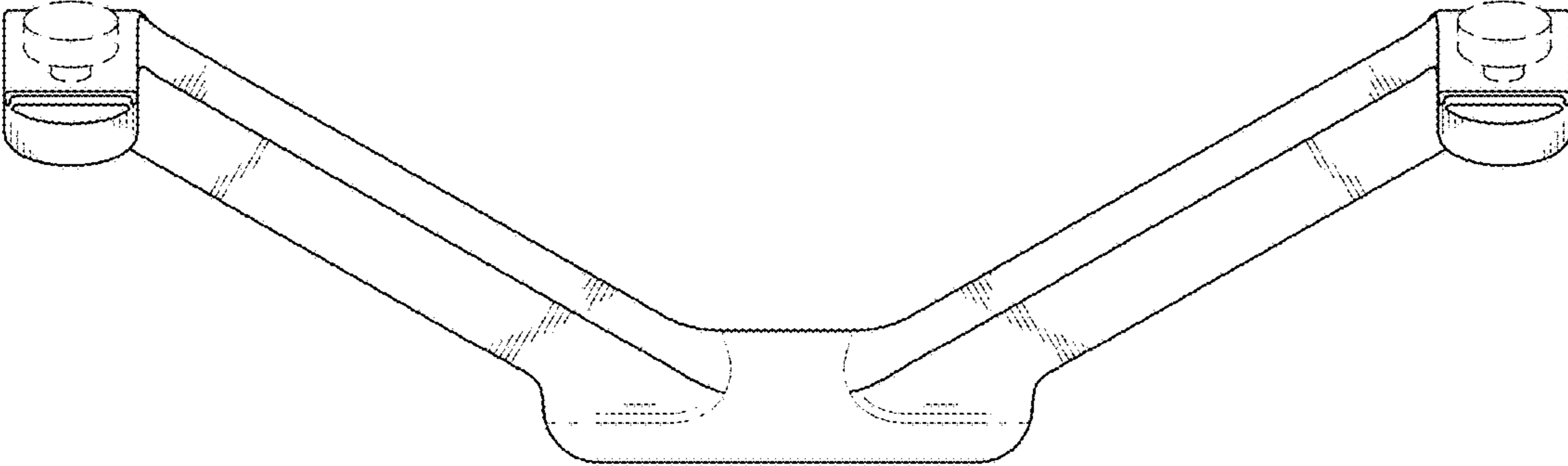

FIG. 6

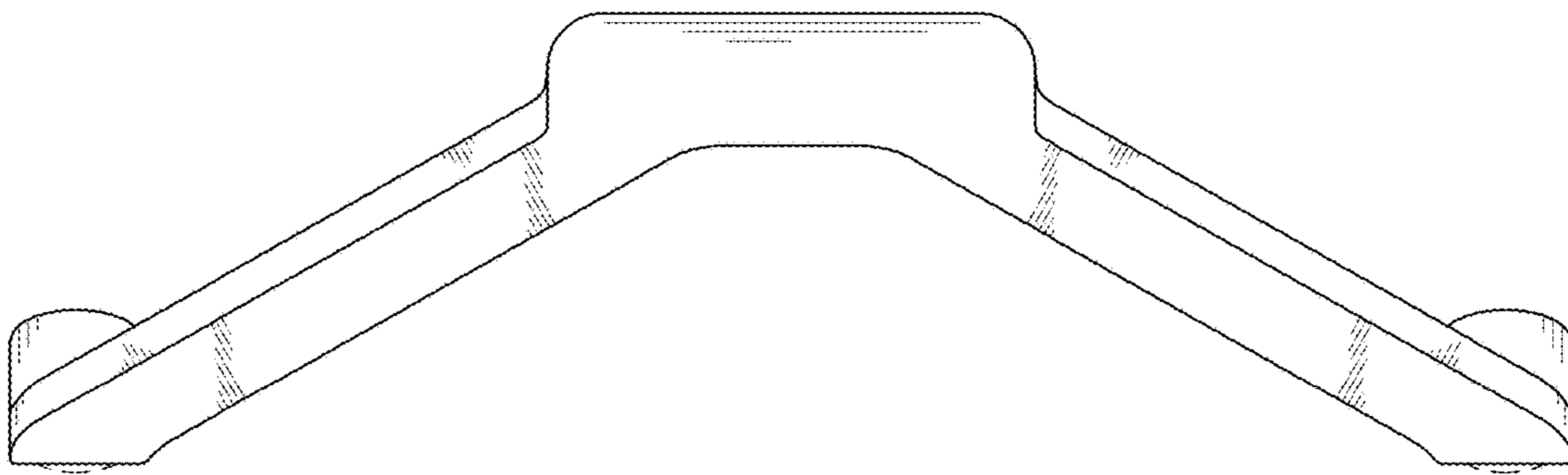

FIG. 7



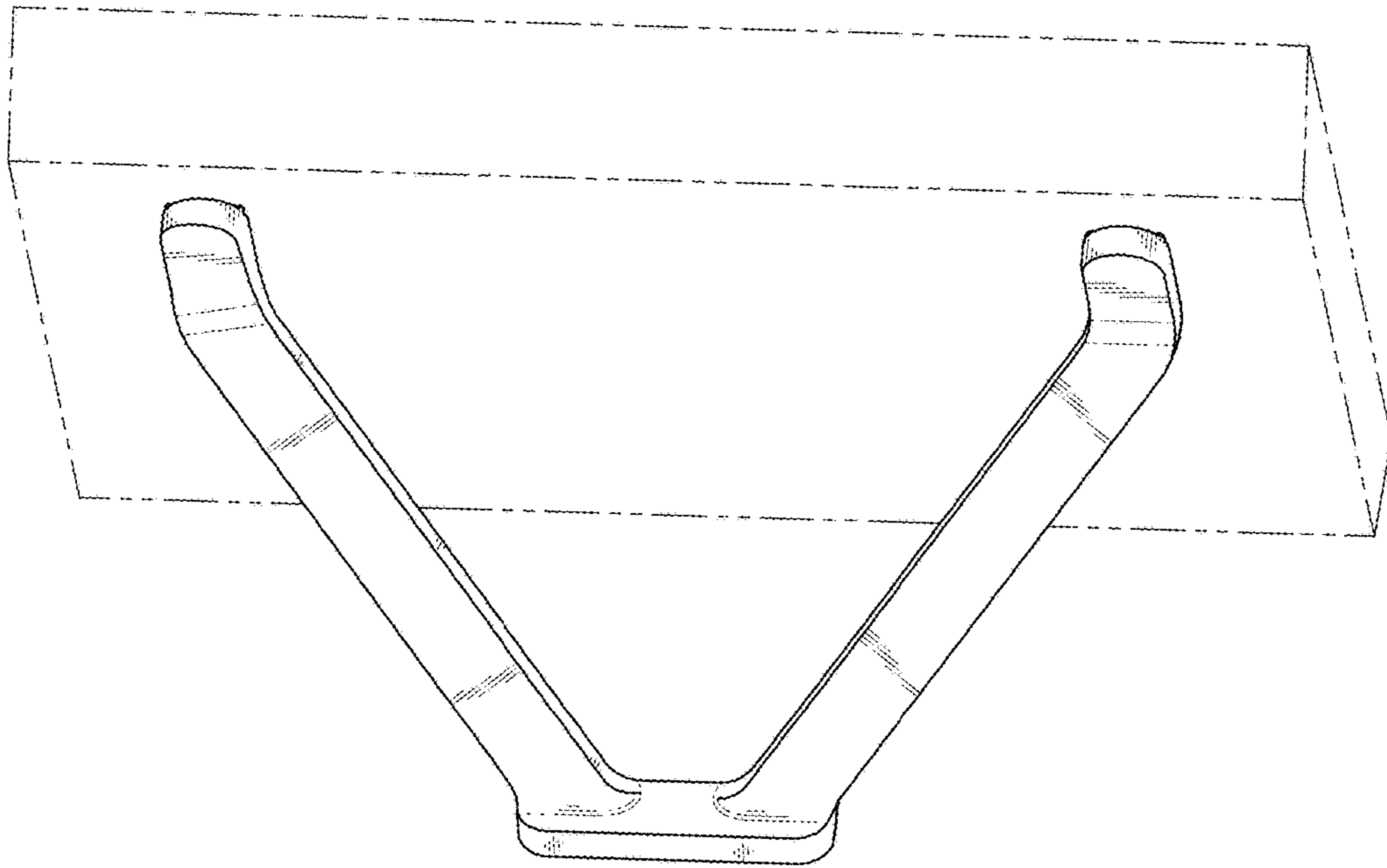

FIG. 8