



US00D772846S

(12) **United States Design Patent** (10) **Patent No.:** **US D772,846 S**
Watanabe (45) **Date of Patent:** **** Nov. 29, 2016**

(54) **COMBINED HEADPHONE AND AUDIO PLAYER**

(71) Applicant: **Sony Corporation**, Tokyo (JP)

(72) Inventor: **Koki Watanabe**, Saitama (JP)

(73) Assignee: **Sony Corporation**, Tokyo (JP)

(**) Term: **15 Years**

(21) Appl. No.: **29/529,762**

(22) Filed: **Jun. 10, 2015**

Related U.S. Application Data

(63) Continuation-in-part of application No. 29/496,002, filed on Jul. 8, 2014, now Pat. No. Des. 745,862, which is a continuation-in-part of application No. 29/421,750, filed on Sep. 14, 2012, now Pat. No. Des. 709,051, which is a continuation-in-part of application No. 29/371,743, filed on Aug. 18, 2011, now Pat. No. Des. 667,817.

(30) **Foreign Application Priority Data**

Feb. 18, 2011 (CN) 2011 3 0025880

(51) **LOC (10) Cl.** **14-01**

(52) **U.S. Cl.**
USPC **D14/223; D14/217**

(58) **Field of Classification Search**

USPC D14/192, 194, 204, 205, 156, 223, 248, D14/249, 137, 138, 142, 138 AD, 147, 148, D14/188, 496, 160, 168, 217, 265; D8/349, D8/14, 21, 29.1, 61, 63; D24/106, 110; 381/312, 315, 72, 74, 73.1, 23.1, 328, 381/329, 150, 151, 370, 376; 181/122, 129, 181/130, 135, 137; 455/1, 440, 344-351, 455/90.3, 575.1, 565; 200/5 B, 5 EB, 200/547-550

CPC H04R 1/10; H04R 1/105; H04R 25/00; H04R 25/02

See application file for complete search history.

(56) **References Cited**

U.S. PATENT DOCUMENTS

4,571,746 A 2/1986 Gorike
5,279,294 A 1/1994 Anderson et al.
5,579,669 A 12/1996 Kind et al.

(Continued)

Primary Examiner — Prabhakar Deshmukh

(74) *Attorney, Agent, or Firm* — Michael Best and Friedrich LLP

(57) **CLAIM**

The ornamental design for a combined headphone and audio player, as shown.

DESCRIPTION

FIG. 1 is a rear, bottom, left perspective view of a first embodiment of a combined headphone and audio player showing our new design;

FIG. 2 is a front elevational view thereof;

FIG. 3 is a rear elevational view thereof;

FIG. 4 is a left side elevational view thereof;

FIG. 5 is a right side elevational view thereof;

FIG. 6 is a top plan view thereof; and

FIG. 7 is a bottom plan view thereof;

FIG. 8 is a front, top, right perspective view of a second embodiment of a combined headphone and audio player showing our new design;

FIG. 9 is a rear, bottom, right perspective view thereof;

FIG. 10 is a front elevational view thereof;

FIG. 11 is a rear elevational view thereof;

FIG. 12 is a left side elevational view thereof;

FIG. 13 is a right side elevational view thereof;

FIG. 14 is a top plan view thereof; and,

FIG. 15 is a bottom plan view thereof.

The broken lines illustrate unclaimed portions of the combined headphone and audio player and form no part of the claimed design.

1 Claim, 11 Drawing Sheets

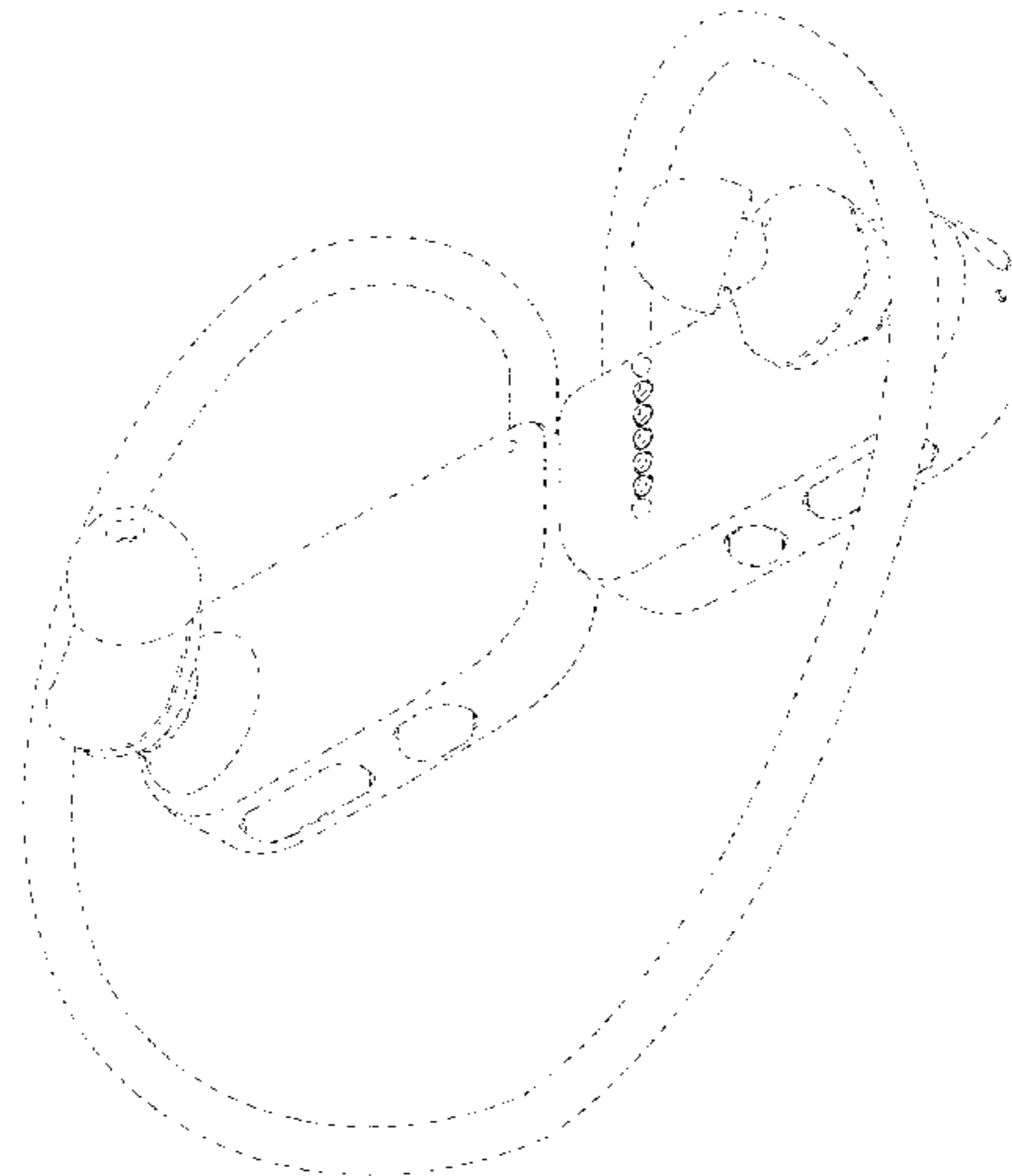
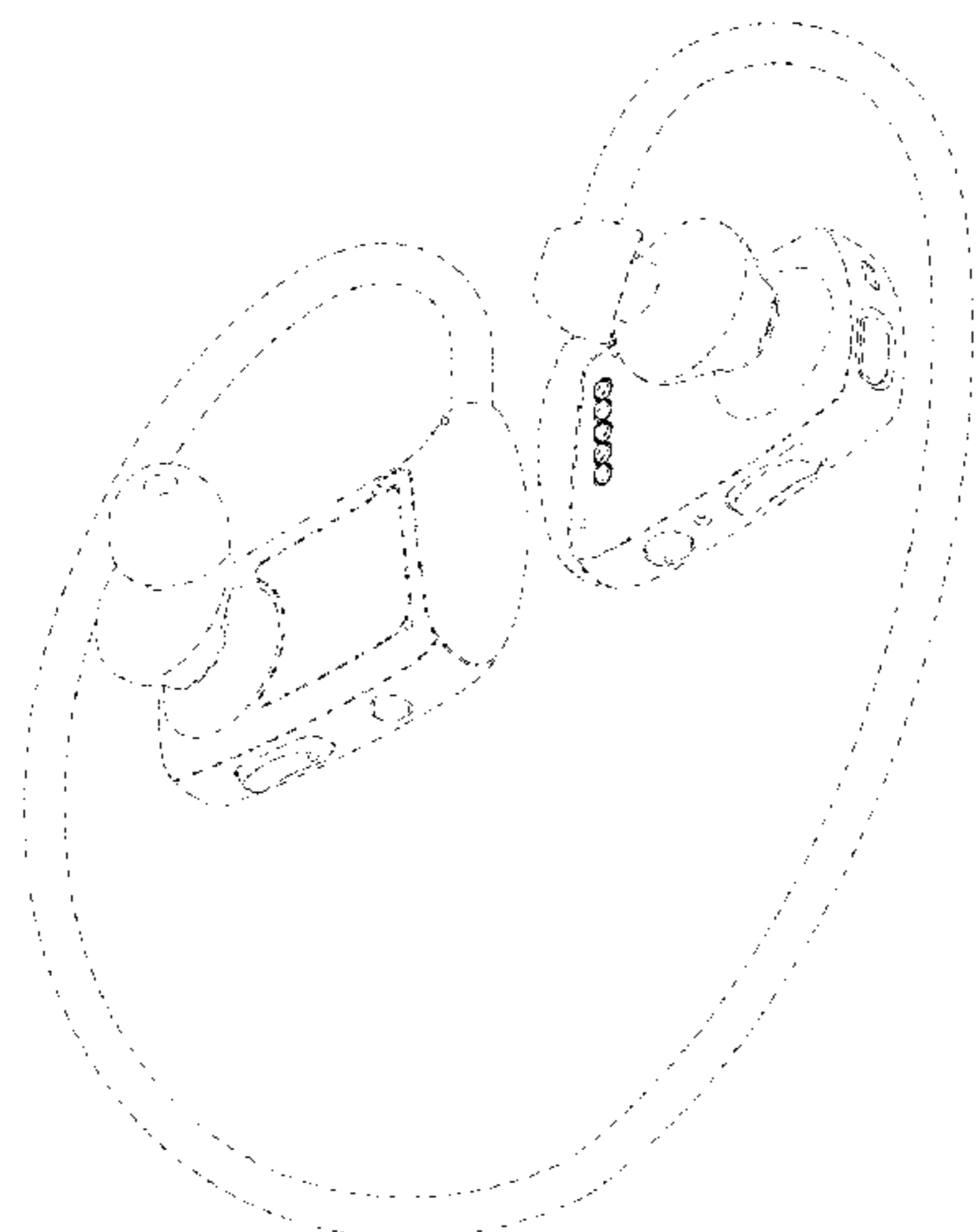

FIG.1

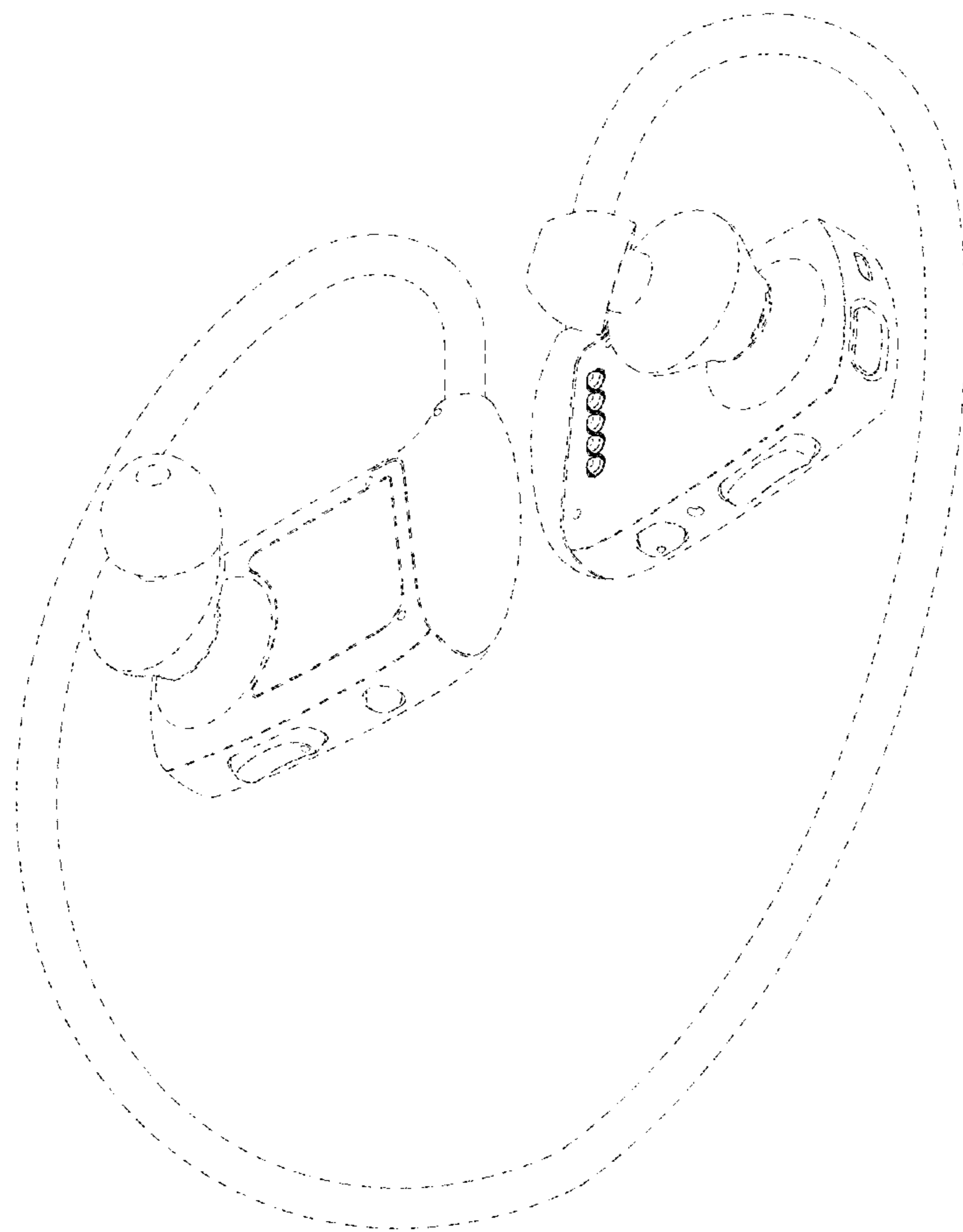

FIG.2

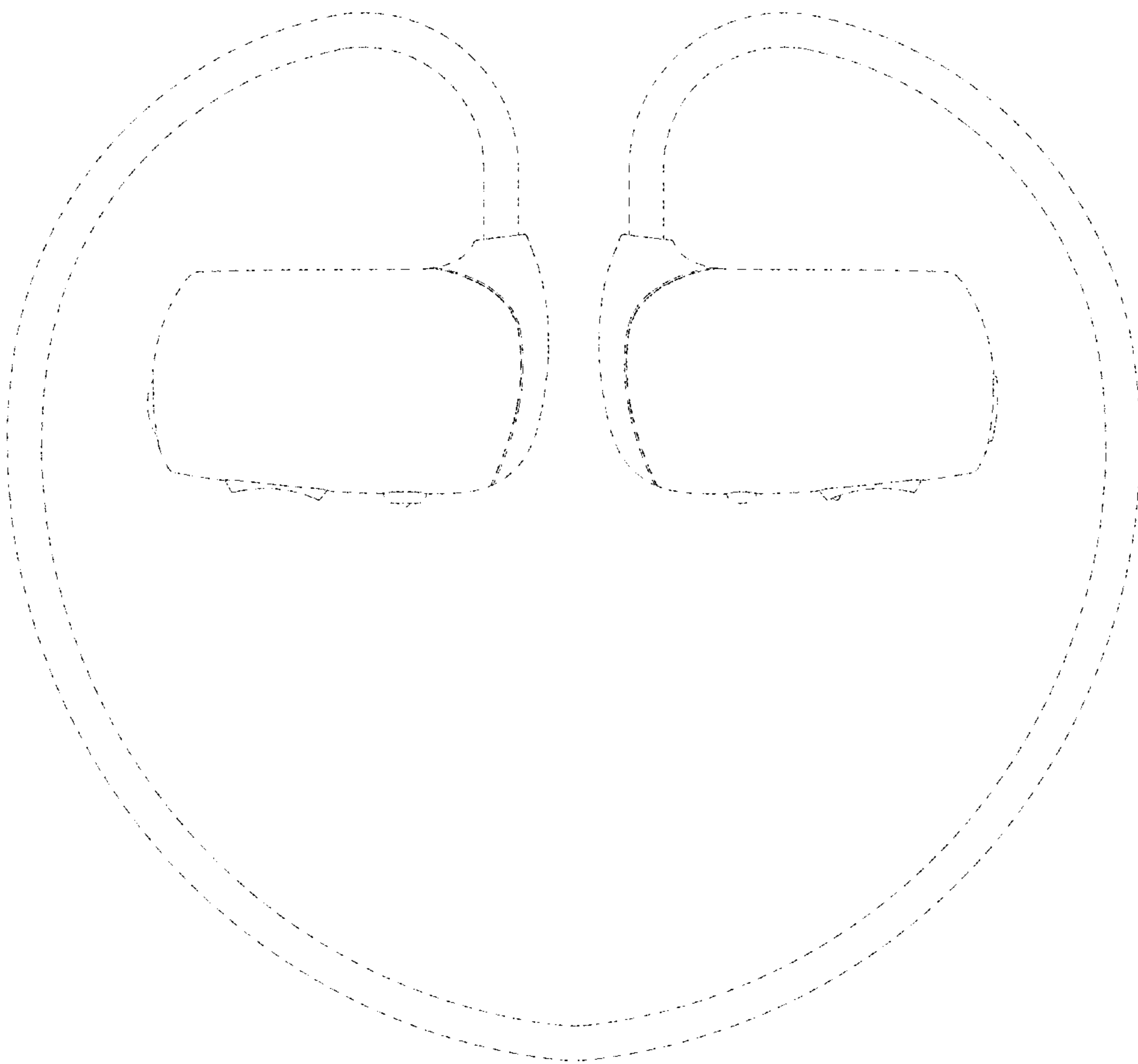

FIG.3

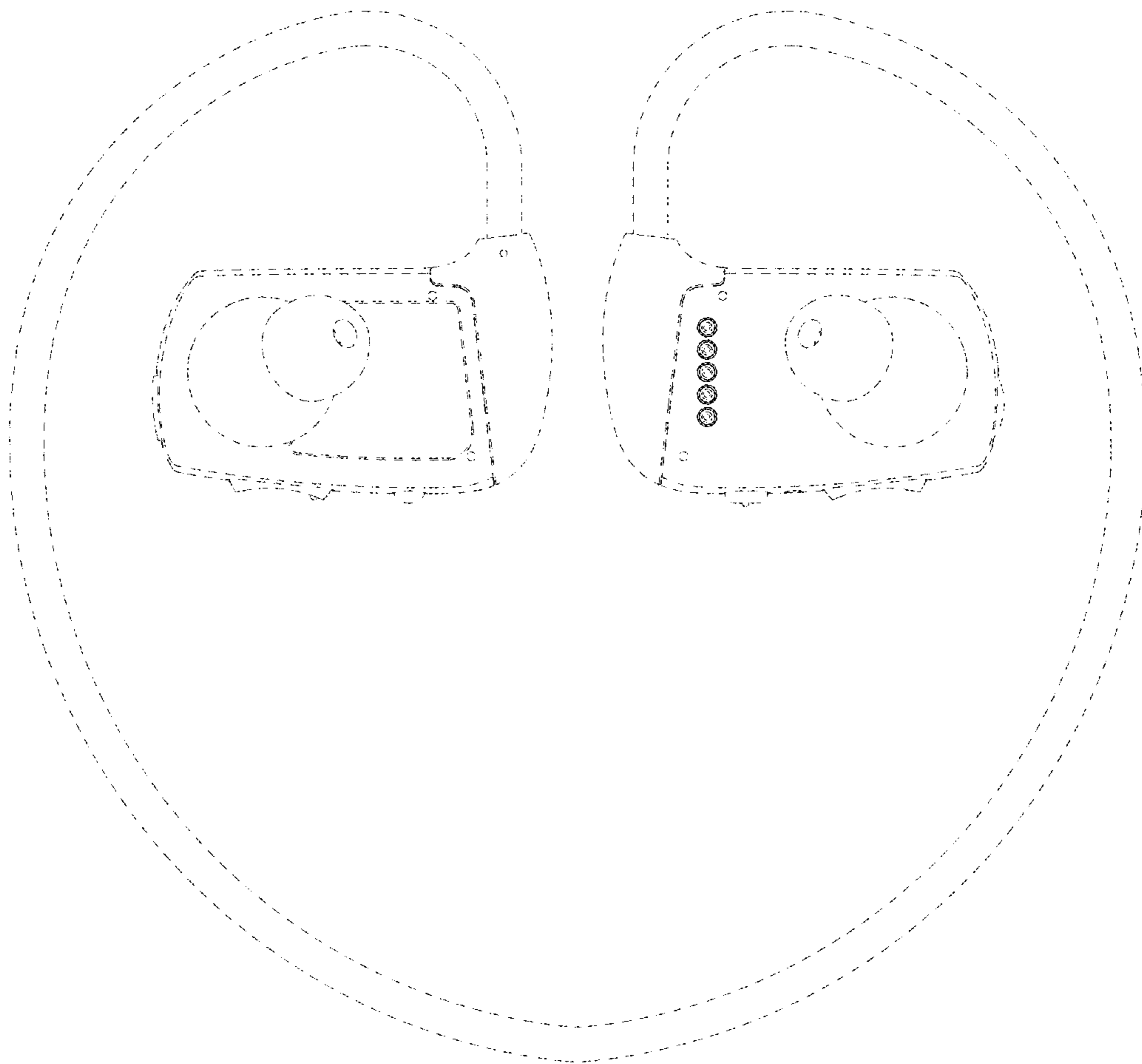

FIG.4

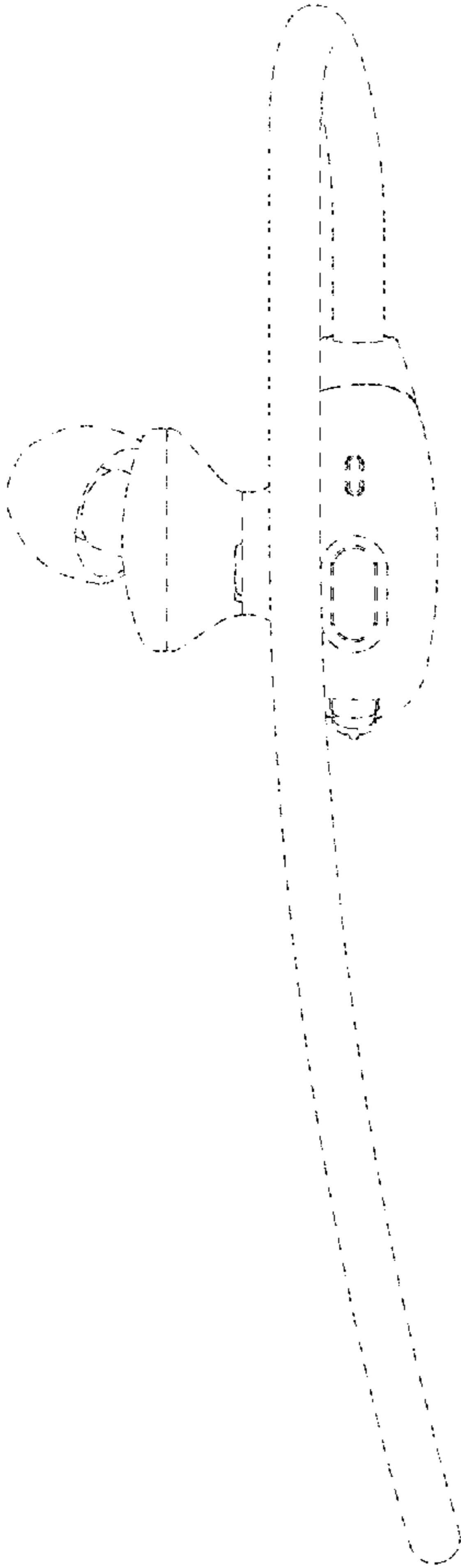

FIG.5

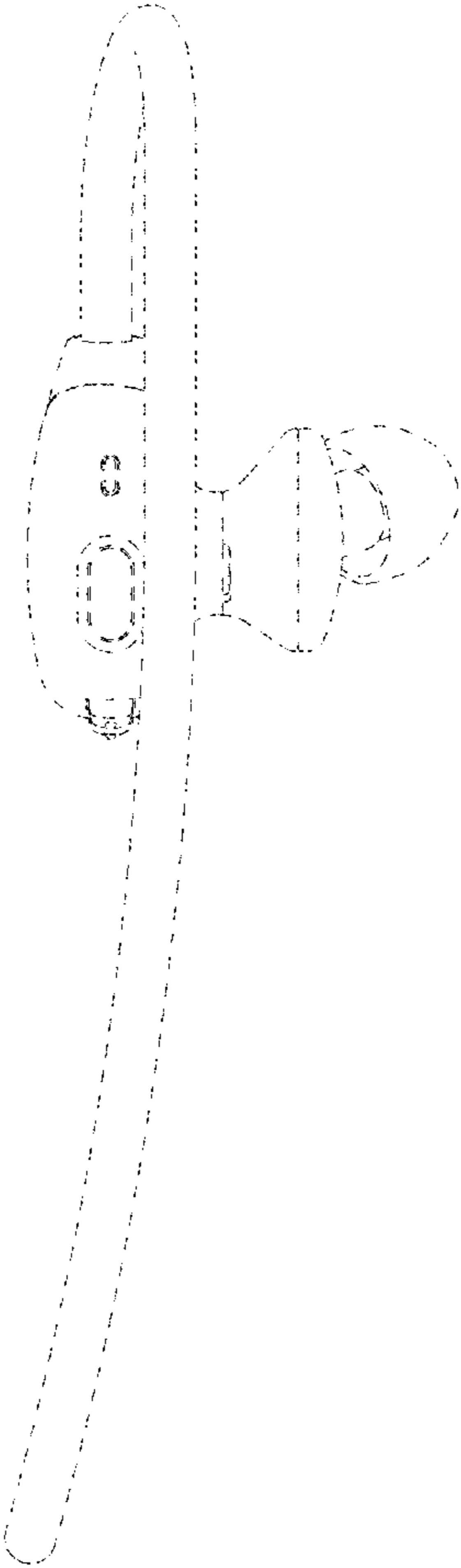

FIG.6

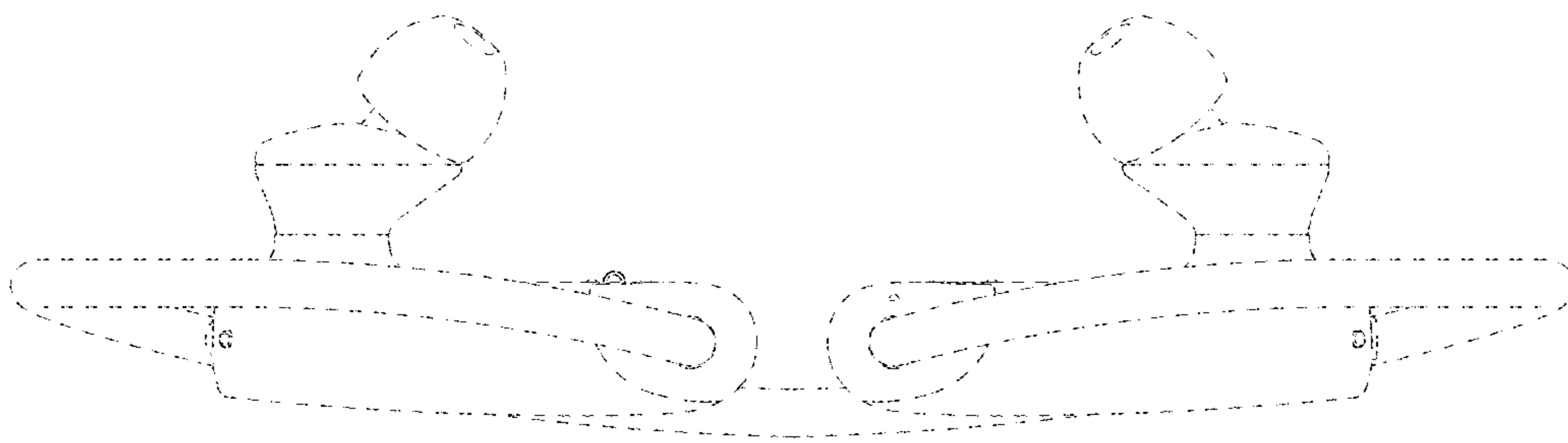

FIG.7

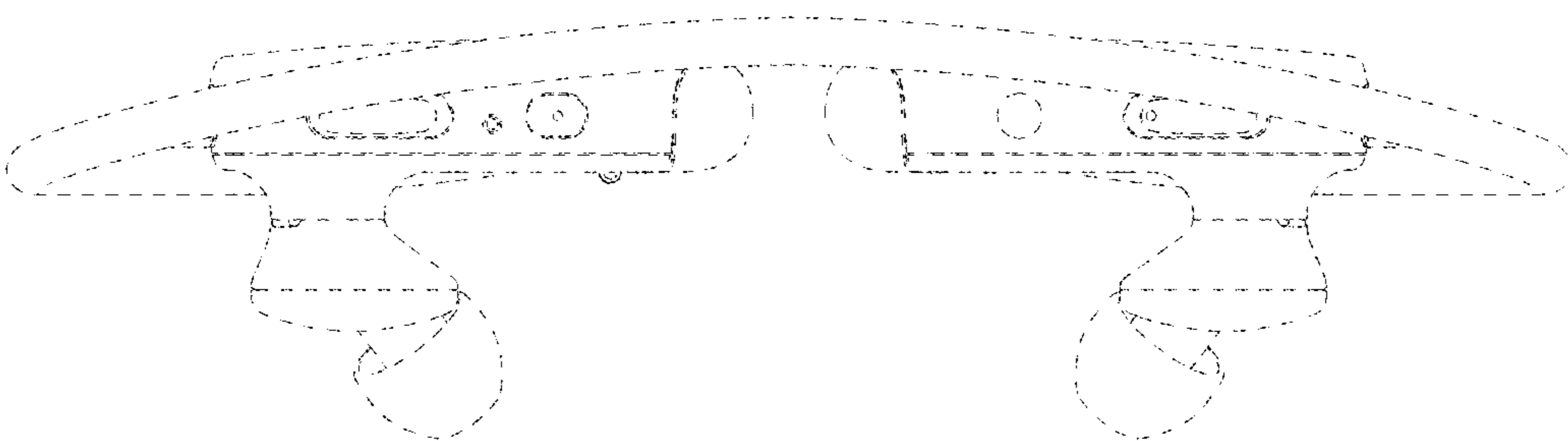

FIG.8

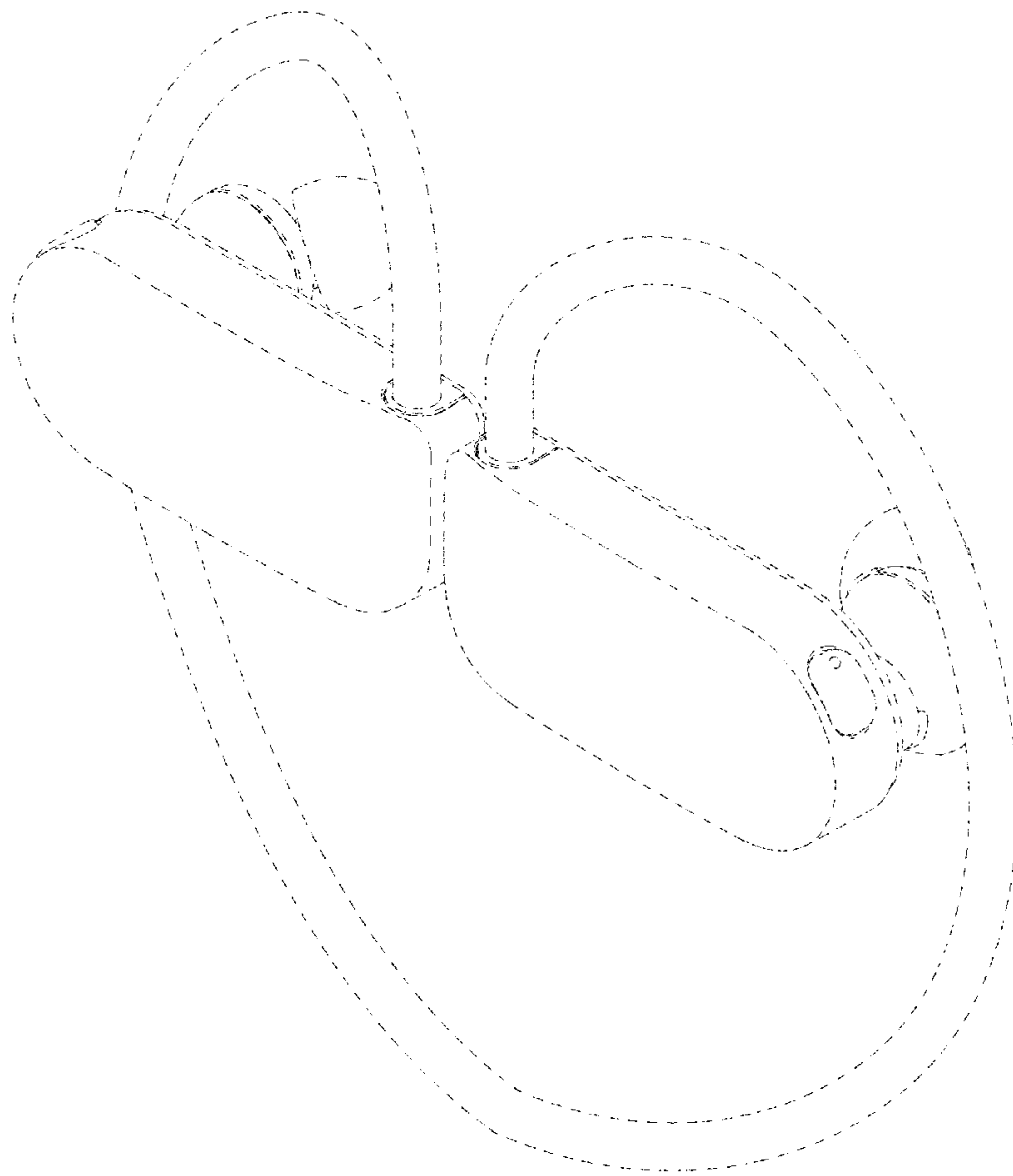

FIG.9

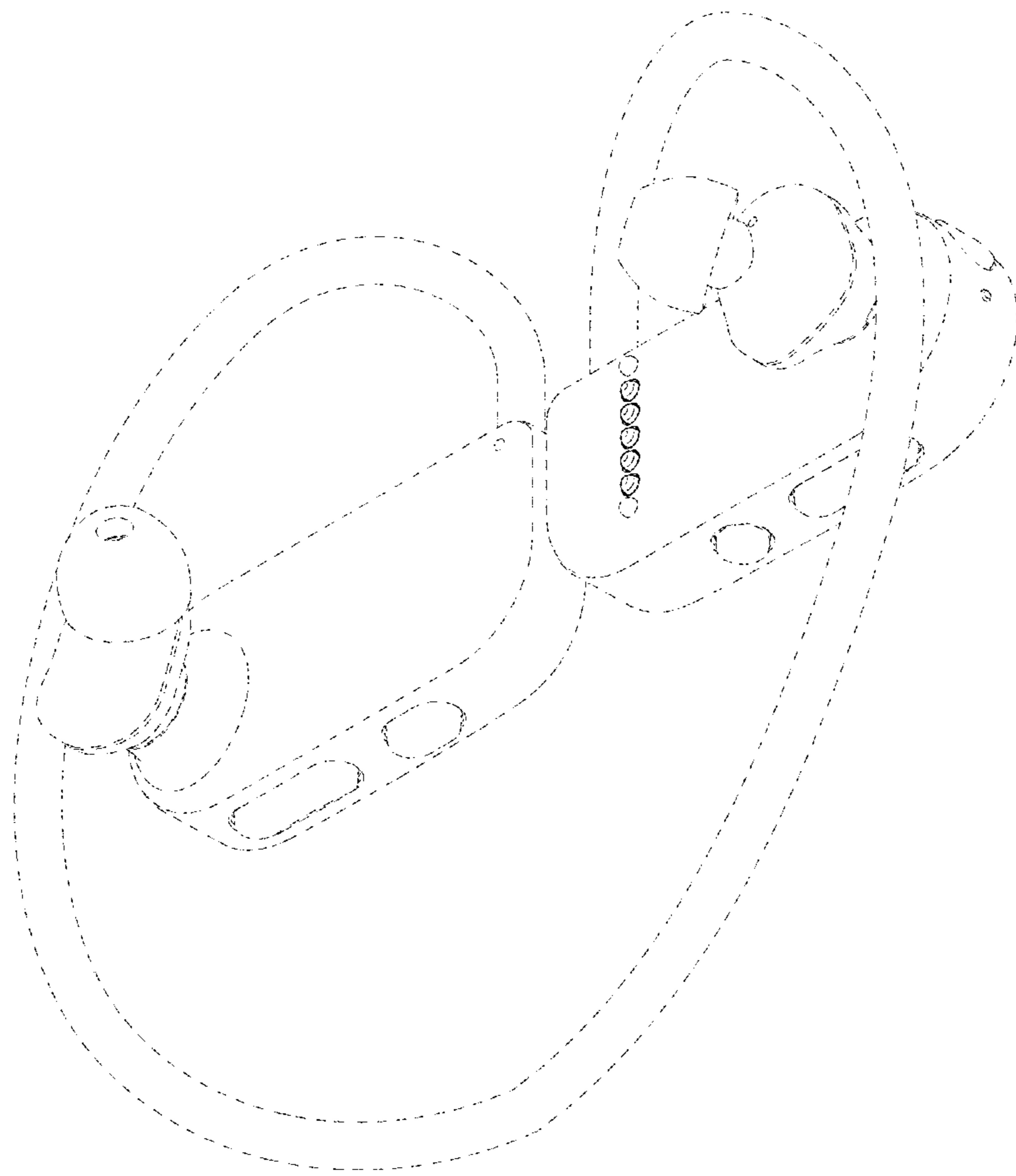

FIG.10

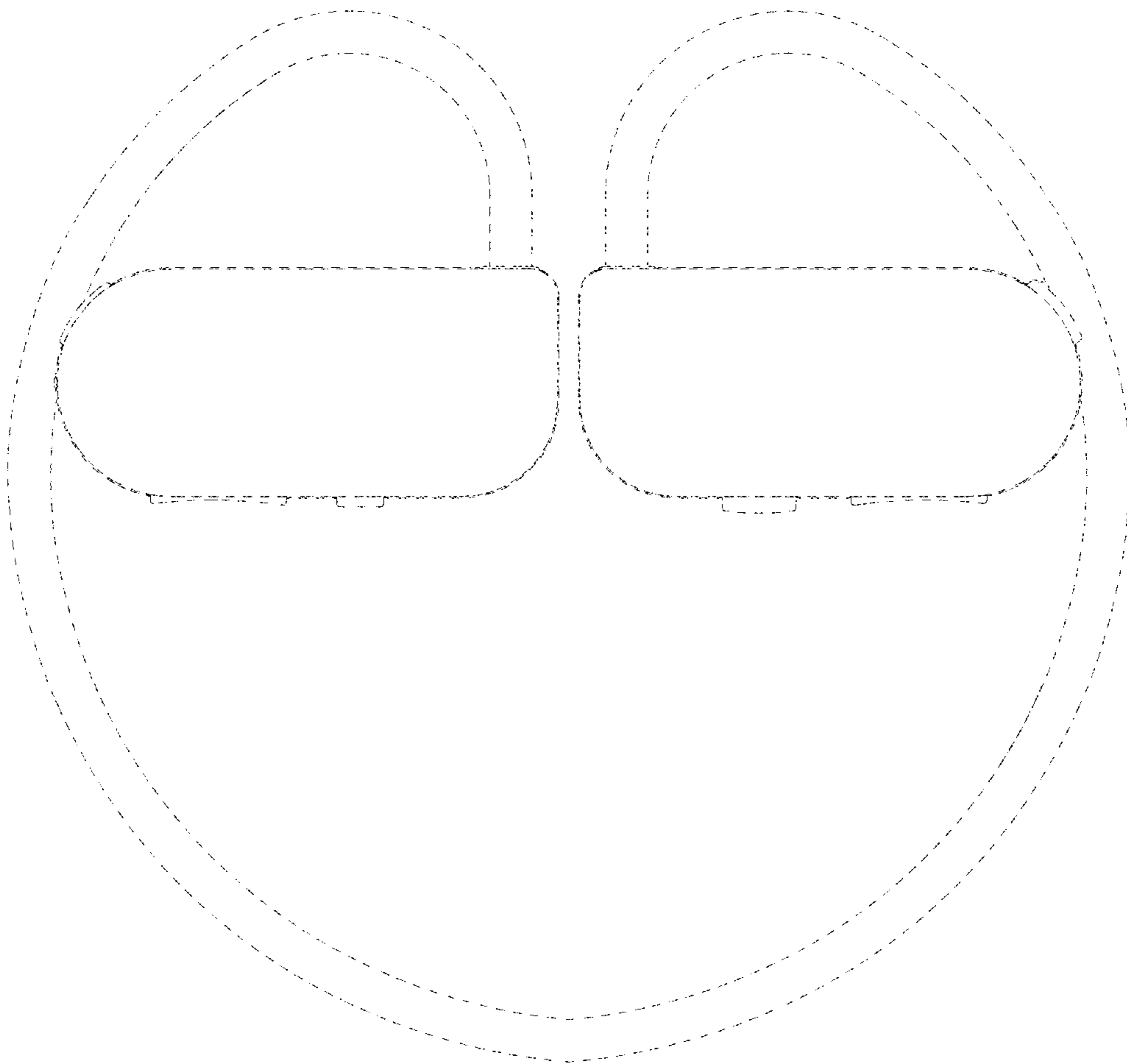

FIG.11

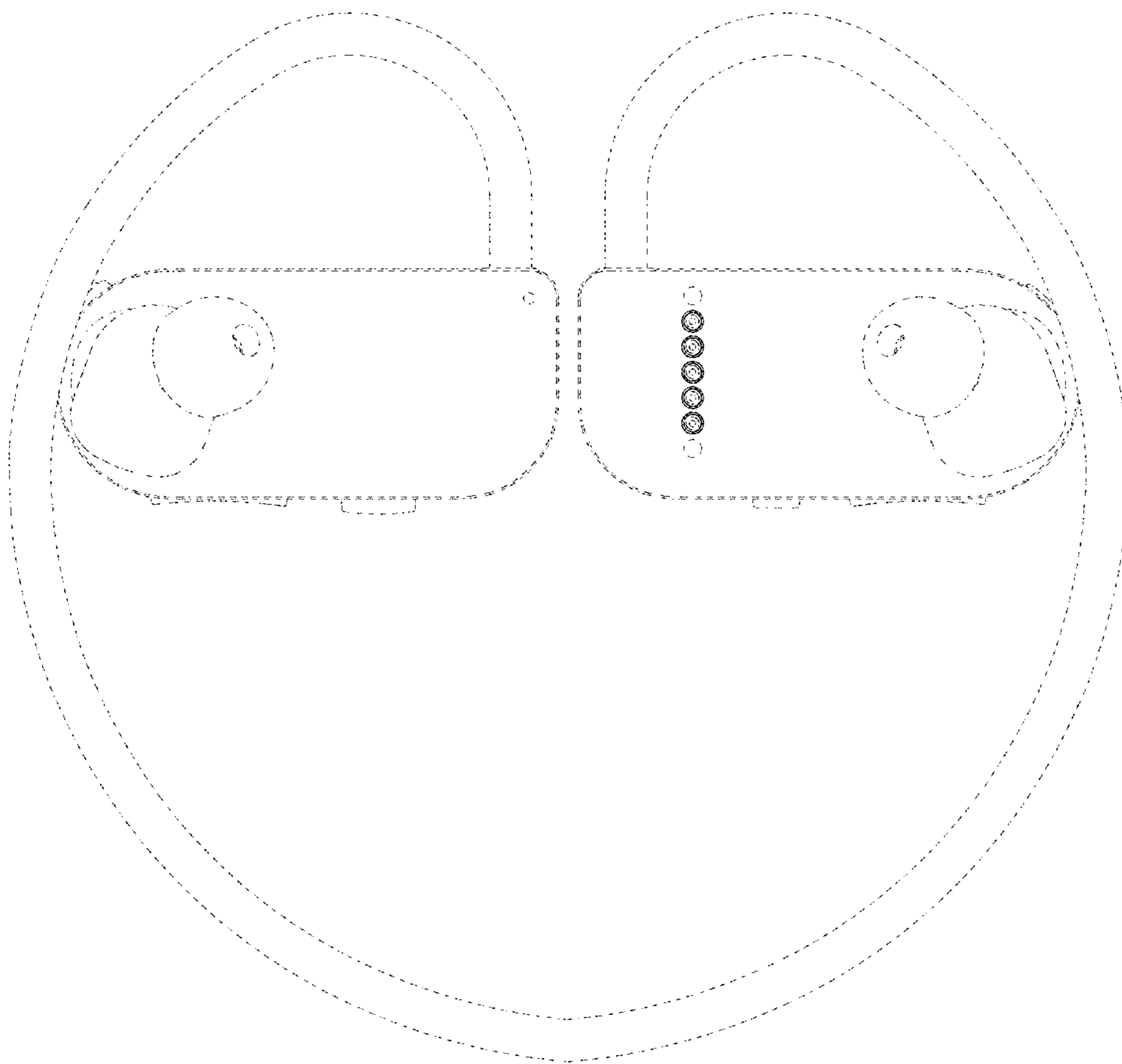

FIG.12

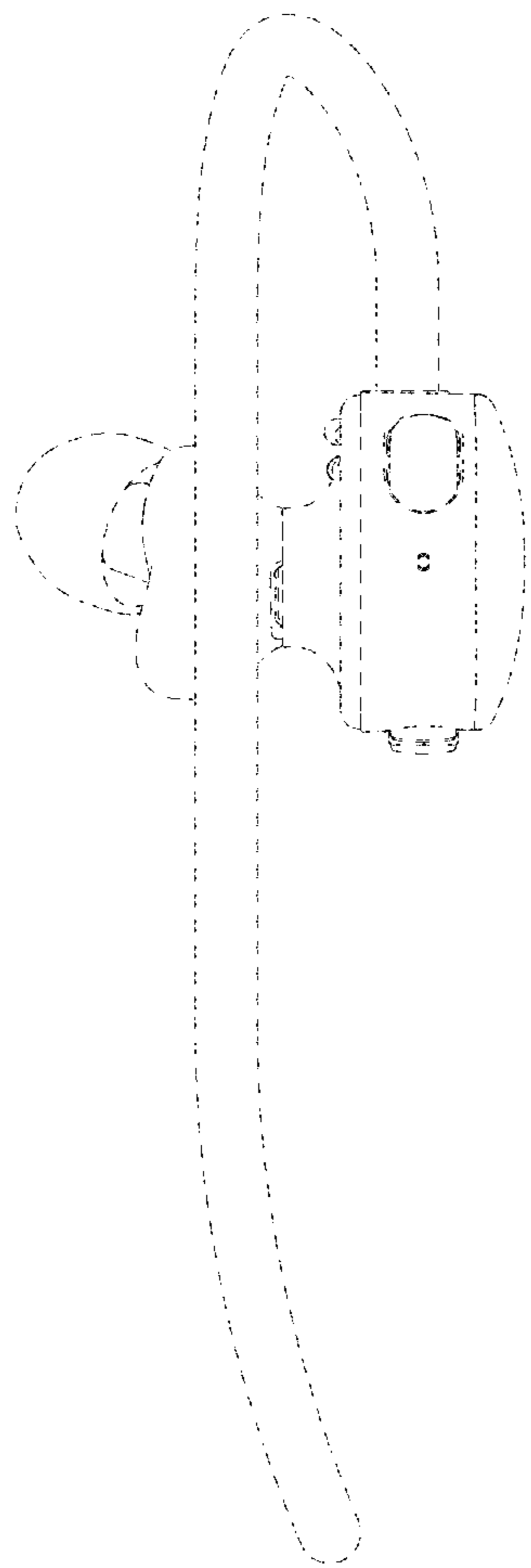

FIG.13

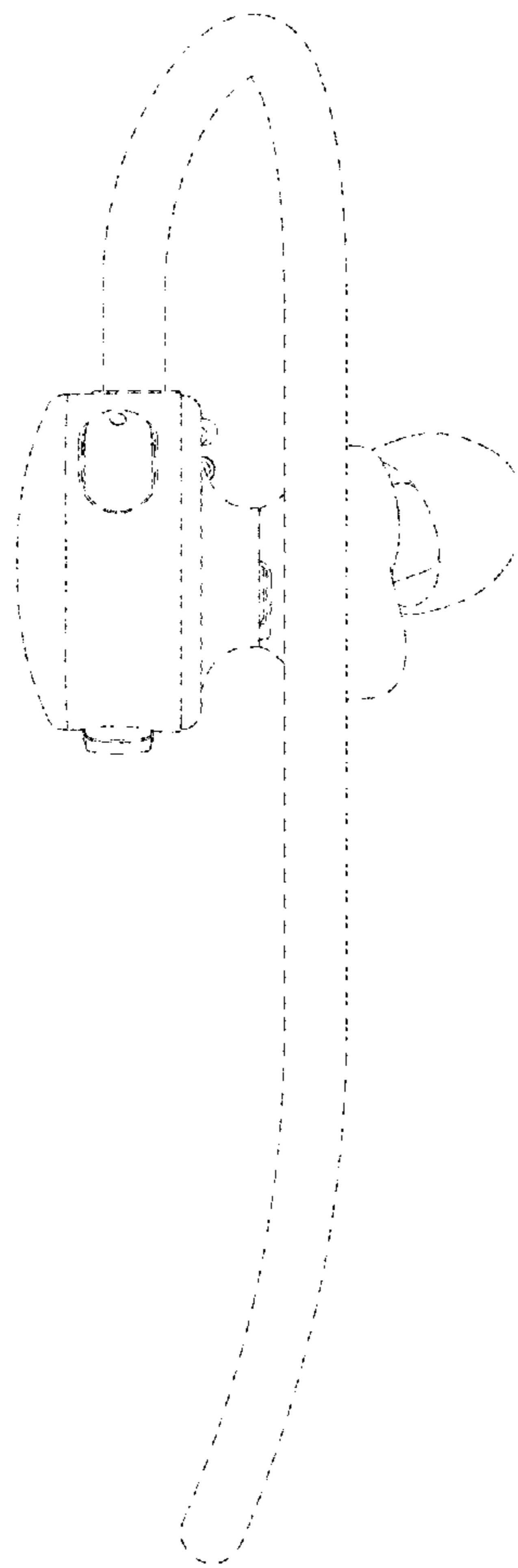

FIG.14

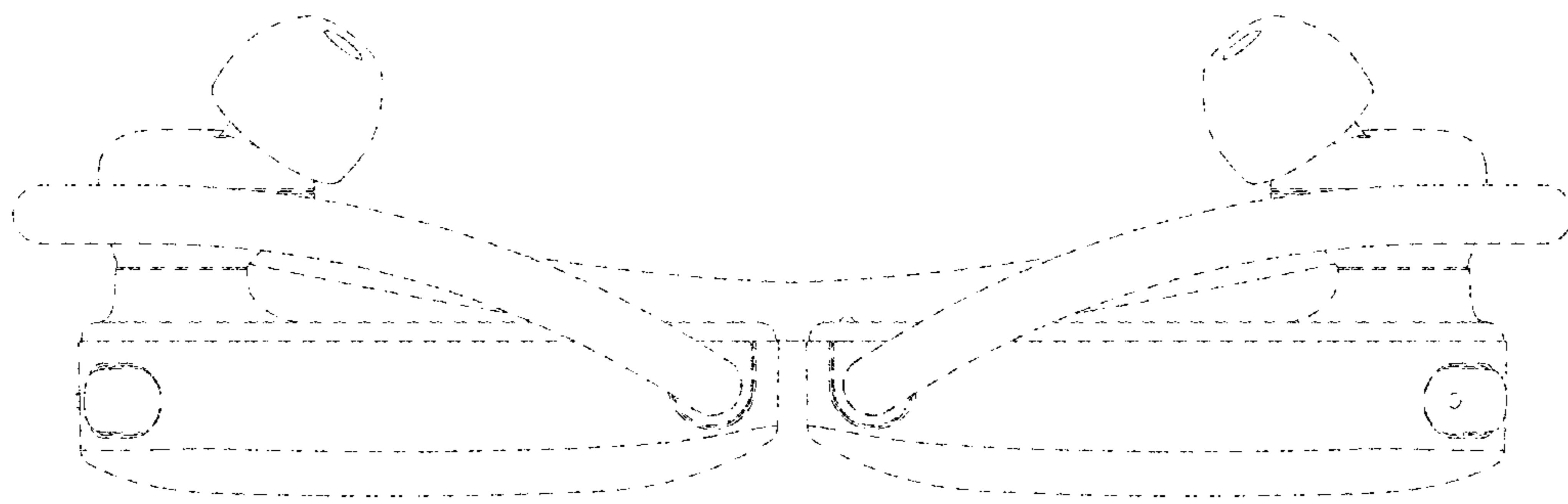

FIG.15

