



US00D772843S

(12) **United States Design Patent**  
**Lee et al.**

(10) **Patent No.:** **US D772,843 S**  
(45) **Date of Patent:** **\*\* Nov. 29, 2016**

- (54) **WIRELESS HEADSET**
- (71) Applicant: **LG ELECTRONICS INC., Seoul (KR)**
- (72) Inventors: **Jonghak Lee, Seoul (KR); Kyubong Choi, Seoul (KR)**
- (73) Assignee: **LG ELECTRONICS INC., Seoul (KR)**
- (\*\*) Term: **15 Years**
- (21) Appl. No.: **29/534,910**
- (22) Filed: **Jul. 31, 2015**
- (30) **Foreign Application Priority Data**  
Feb. 2, 2015 (KR) ..... 30-2015-0005723
- (51) **LOC (10) Cl.** ..... **14-01**
- (52) **U.S. Cl.**  
USPC ..... **D14/205**
- (58) **Field of Classification Search**  
USPC ..... D14/205, 188, 192, 372; D24/106;  
128/864, 865; D16/309; 2/209.3;  
181/129, 130, 135; 379/430, 431;  
381/74, 374, 380, 381, 183, 151, 311,  
381/326, 384, 378, 379, 351, 377; 351/157,  
351/158; 455/90.3, 100, 569.1, 575.2  
CPC ..... H04R 25/00; H04R 1/10; H04R 1/1066;  
H04R 1/1016; H04R 5/033; H04R 5/0335;  
H04R 1/1033; H04R 1/105  
See application file for complete search history.

- (56) **References Cited**  
**U.S. PATENT DOCUMENTS**  
2,481,946 A \* 9/1949 Pendleton ..... G02C 3/003  
2/450  
2,891,116 A \* 6/1959 Nichols ..... H04R 25/602  
381/323  
D318,669 S \* 7/1991 Nakayama ..... D14/205  
D331,057 S \* 11/1992 Isonaga ..... D14/205

- D337,587 S \* 7/1993 Nakayama ..... D14/205
- D350,354 S \* 9/1994 Nakamura ..... D14/205
- D351,597 S \* 10/1994 Nakamura ..... D14/205
- D394,436 S \* 5/1998 Hall ..... D14/206
- 6,010,216 A \* 1/2000 Jesiek ..... H04B 1/385  
351/158
- D449,290 S \* 10/2001 Taylor ..... D14/206
- D458,245 S \* 6/2002 Masuda ..... D14/192
- 6,603,863 B1 \* 8/2003 Nagayoshi ..... H04R 5/0335  
381/370
- D550,202 S \* 9/2007 Meier ..... D14/206
- D560,206 S \* 1/2008 Hermansen ..... D14/206
- D575,268 S \* 8/2008 Christopher ..... D14/205
- D579,442 S \* 10/2008 Kim ..... D14/205
- D583,800 S \* 12/2008 Jaakkola ..... D14/205
- D587,678 S \* 3/2009 Yuyama ..... D14/205
- D587,680 S \* 3/2009 Komiyama ..... D14/205
- D593,067 S \* 5/2009 Millora ..... D14/205
- D593,538 S \* 6/2009 Chon ..... D14/205
- D594,442 S \* 6/2009 Chon ..... D14/205
- D596,617 S \* 7/2009 Devlas ..... D14/205
- D604,269 S \* 11/2009 Choe ..... D14/205

(Continued)

*Primary Examiner* — Paula Greene  
(74) *Attorney, Agent, or Firm* — Birch, Stewart, Kolasch & Birch, LLP

(57) **CLAIM**  
The ornamental design for a wireless headset, as shown and described.

**DESCRIPTION**

FIG. 1 is a perspective view of a wireless headset showing our new design;  
FIG. 2 is a front view thereof;  
FIG. 3 is a rear view thereof;  
FIG. 4 is a left side view thereof where the right side view is a mirror image;  
FIG. 5 is a top plan view thereof;  
FIG. 6 is a bottom plan view thereof; and,  
FIG. 7 is a reference view thereof showing an example of the usage of the subject design.  
The broken lines depict portions of the wireless headset that form no part of the claimed design.

**1 Claim, 6 Drawing Sheets**

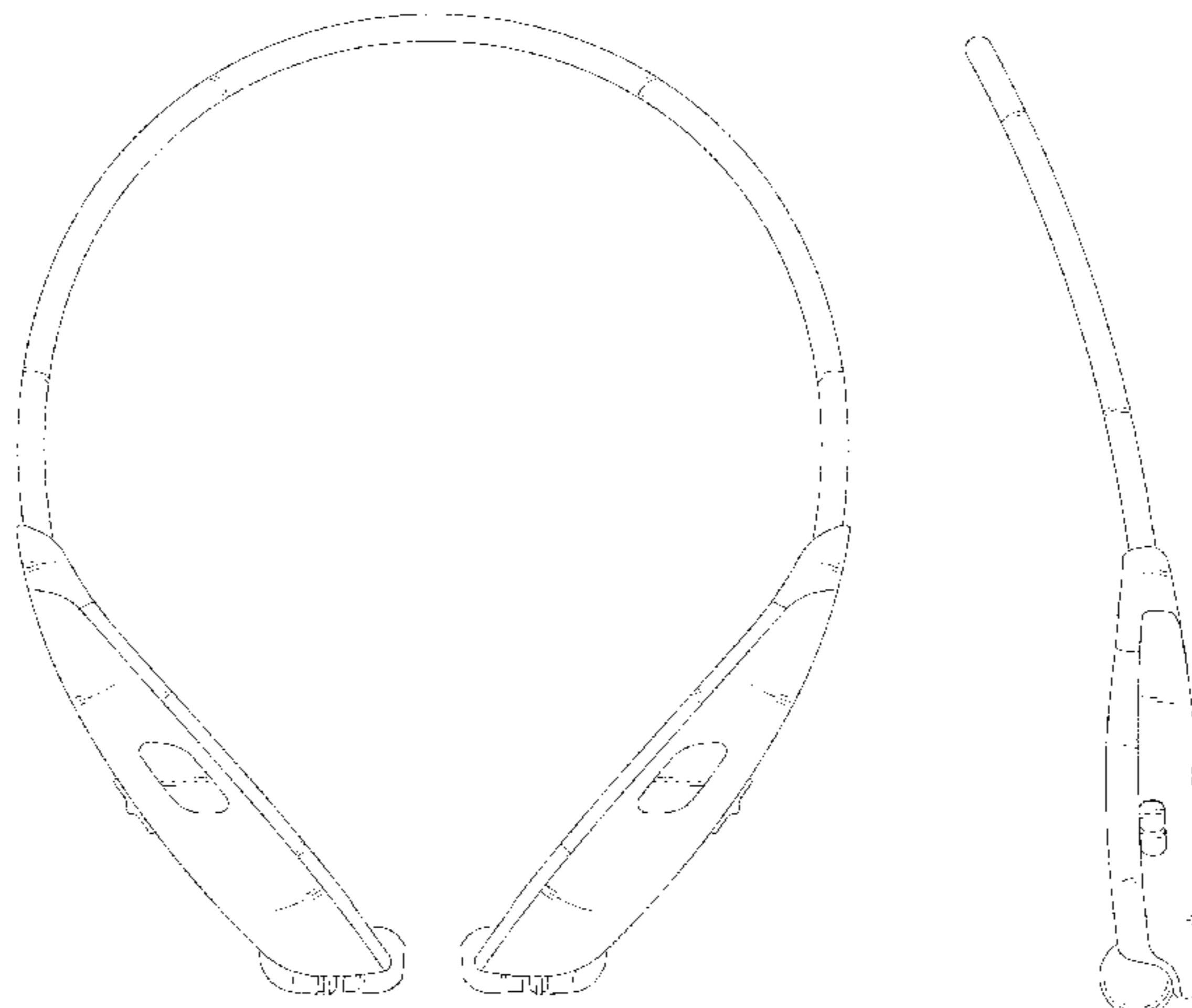

(56)

References Cited

U.S. PATENT DOCUMENTS

D605,168 S \* 12/2009 Jaakkola ..... D14/205  
 D617,308 S \* 6/2010 Nousiainen ..... D14/205  
 7,920,902 B2 \* 4/2011 Carroll ..... H04M 1/6066  
 381/74  
 D643,830 S \* 8/2011 Fish ..... D14/205  
 8,009,853 B2 \* 8/2011 Ito ..... H04R 1/1066  
 381/370  
 D645,444 S \* 9/2011 Quek ..... D14/205  
 D653,234 S \* 1/2012 Lee ..... D14/205  
 8,094,858 B2 \* 1/2012 Thiel ..... G02C 3/003  
 381/327  
 D663,714 S \* 7/2012 Kang ..... D14/205  
 D669,881 S \* 10/2012 Clements ..... D14/205  
 8,290,193 B2 \* 10/2012 Pang ..... H04R 1/1033  
 381/370  
 8,363,875 B2 \* 1/2013 Ito ..... H04R 1/1066  
 381/379  
 D678,857 S \* 3/2013 Feng ..... D14/205  
 8,411,893 B2 \* 4/2013 Ito ..... H04R 1/105  
 181/135  
 8,433,082 B2 \* 4/2013 Abolfathi ..... H04R 1/46  
 381/151  
 D686,189 S \* 7/2013 Lu ..... D14/205  
 D703,634 S \* 4/2014 Han ..... D14/205  
 D706,745 S \* 6/2014 Nakagawa ..... D14/205  
 D707,199 S \* 6/2014 Cephress ..... D14/205  
 8,761,430 B2 \* 6/2014 Zimmerman ..... H04R 1/1033  
 381/374

D712,371 S \* 9/2014 Henning ..... D14/205  
 8,873,250 B2 \* 10/2014 Kroupa ..... B65H 75/4434  
 242/400  
 D716,759 S \* 11/2014 Ha ..... D14/205  
 D721,673 S \* 1/2015 Park ..... D14/205  
 D723,510 S \* 3/2015 Ishikura ..... D14/205  
 D730,867 S \* 6/2015 Park ..... D14/205  
 D731,999 S \* 6/2015 Cephress ..... D14/205  
 9,055,795 B2 \* 6/2015 Larkin ..... A45C 11/00  
 D740,785 S \* 10/2015 Chen ..... D14/205  
 D743,933 S \* 11/2015 Park ..... D14/205  
 D743,935 S \* 11/2015 Wapler ..... D14/205  
 D745,490 S \* 12/2015 Zheng ..... D14/205  
 D752,026 S \* 3/2016 Yang ..... D14/223  
 D756,958 S \* 5/2016 Lee ..... D14/205  
 D756,959 S \* 5/2016 Lee ..... D14/205  
 2007/0003093 A1 \* 1/2007 Ito ..... H04R 5/0335  
 381/378  
 2009/0274335 A1 \* 11/2009 Cheung ..... H04R 5/0335  
 381/374  
 2010/0283962 A1 \* 11/2010 Williams ..... G02C 3/003  
 351/157  
 2011/0170702 A1 \* 7/2011 Bays ..... H04R 5/0335  
 381/74  
 2012/0170702 A1 \* 7/2012 Song ..... F22B 35/004  
 376/210  
 2013/0329903 A1 \* 12/2013 Ting ..... H04R 1/105  
 381/74  
 2014/0185837 A1 \* 7/2014 Kunimoto ..... H04R 1/1075  
 381/151

\* cited by examiner

FIG. 1

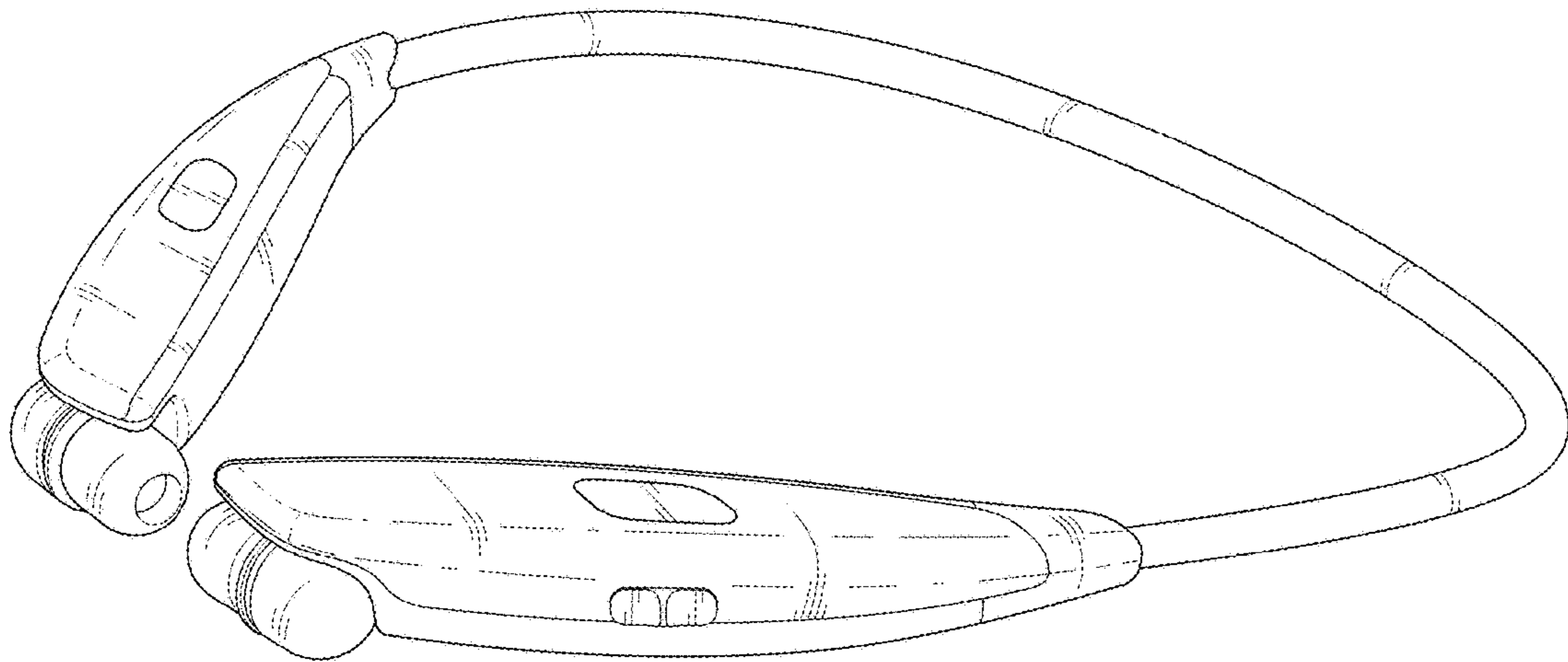

FIG. 2

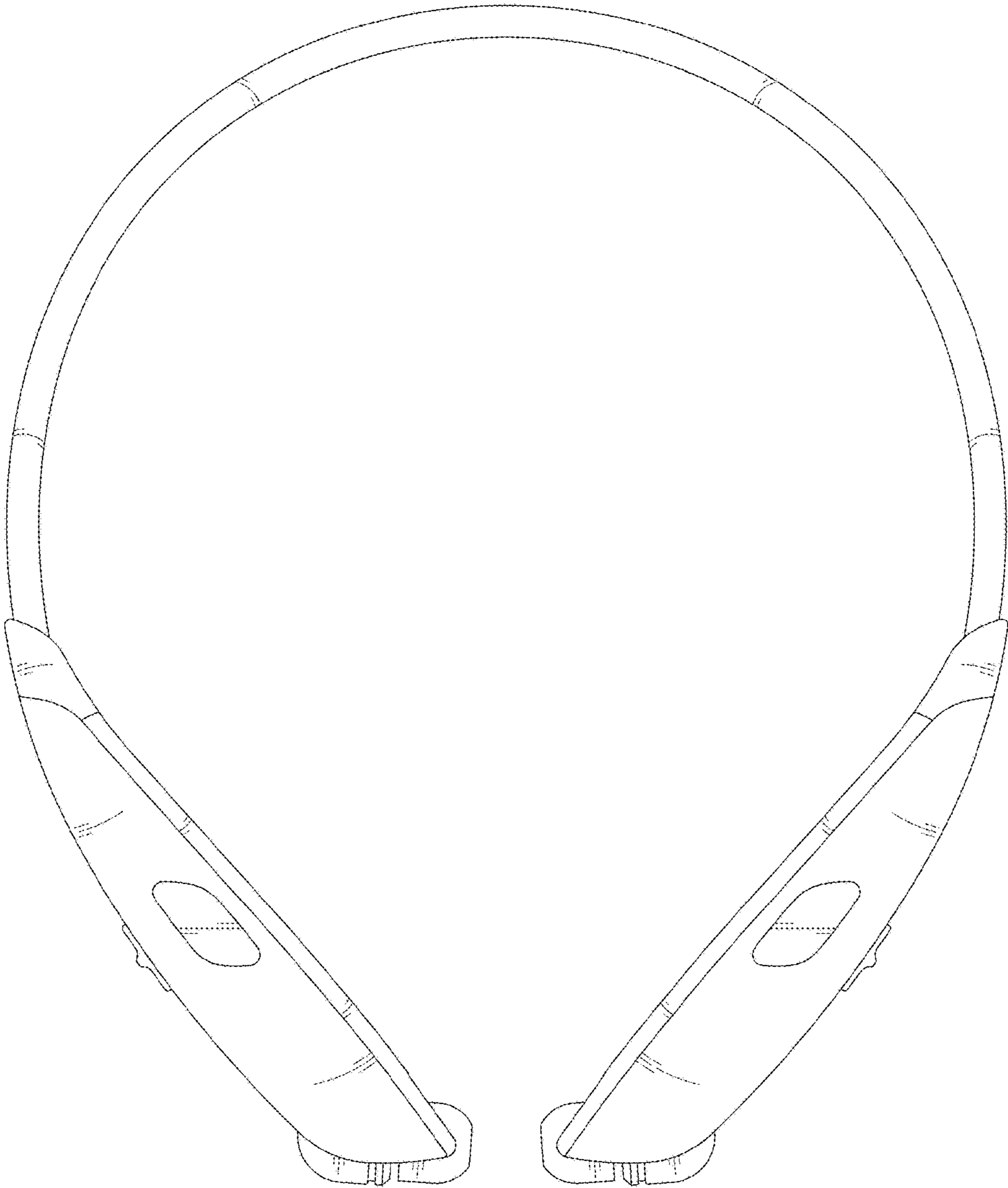

FIG. 3

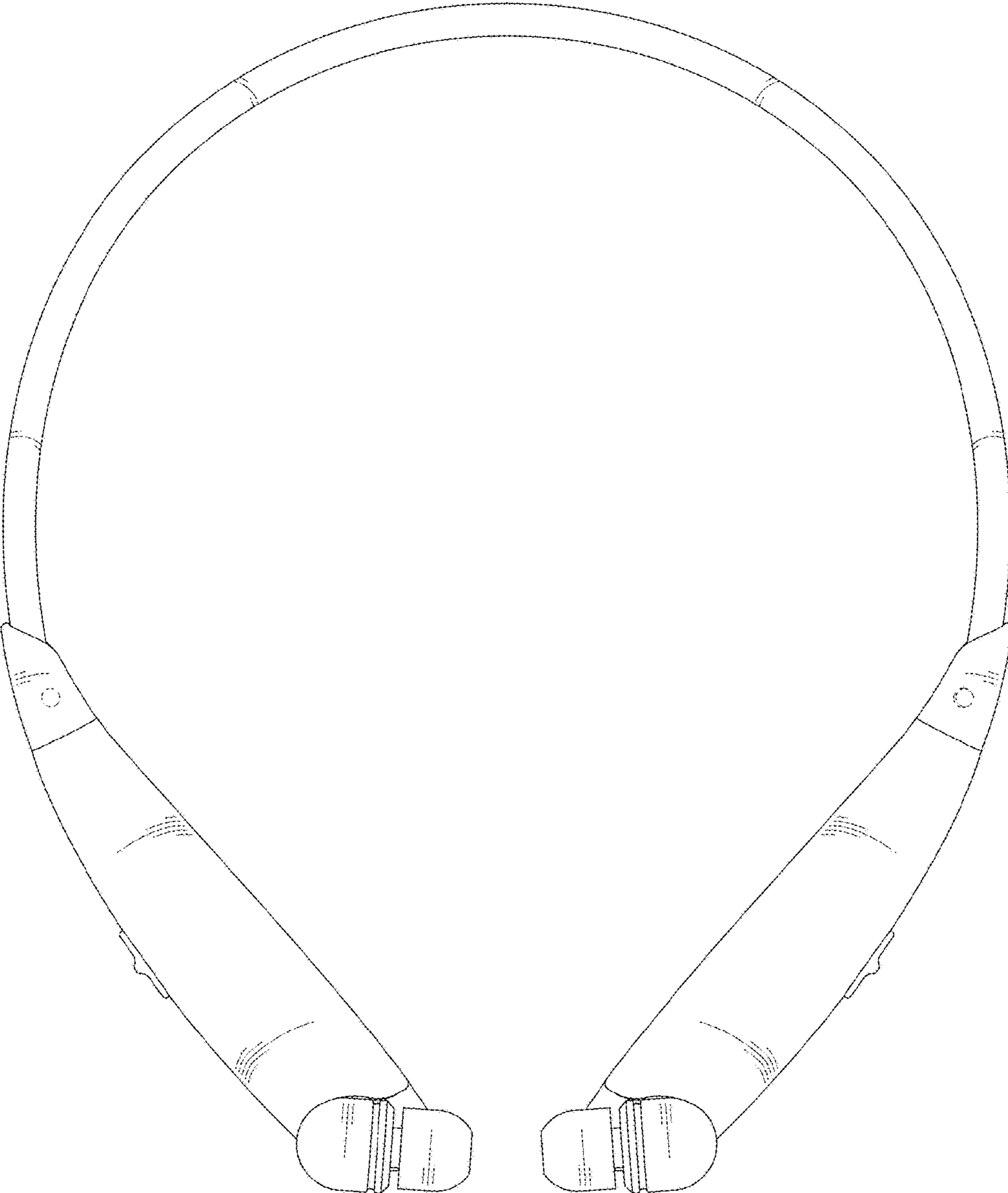

FIG. 4

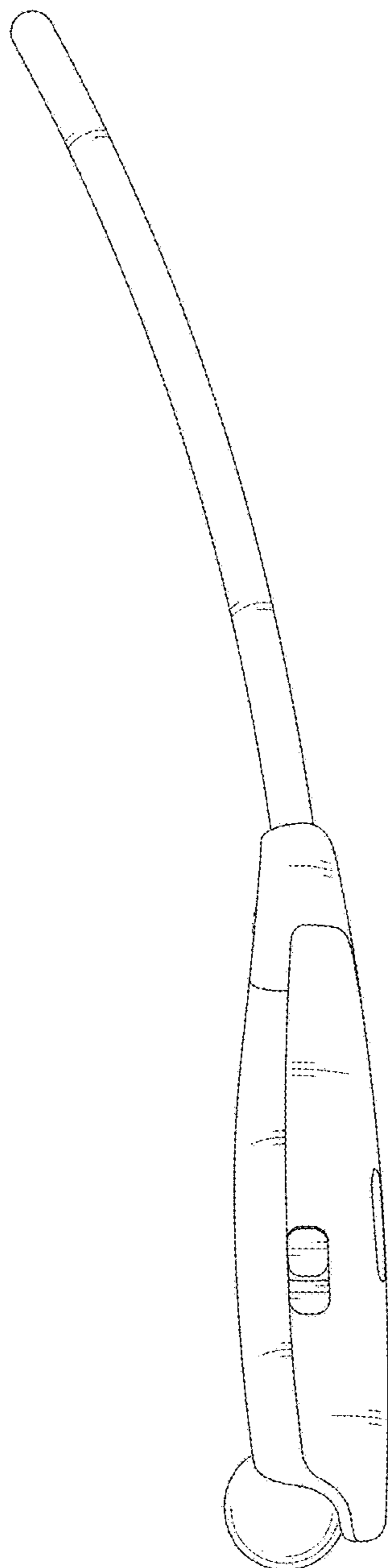

FIG. 5

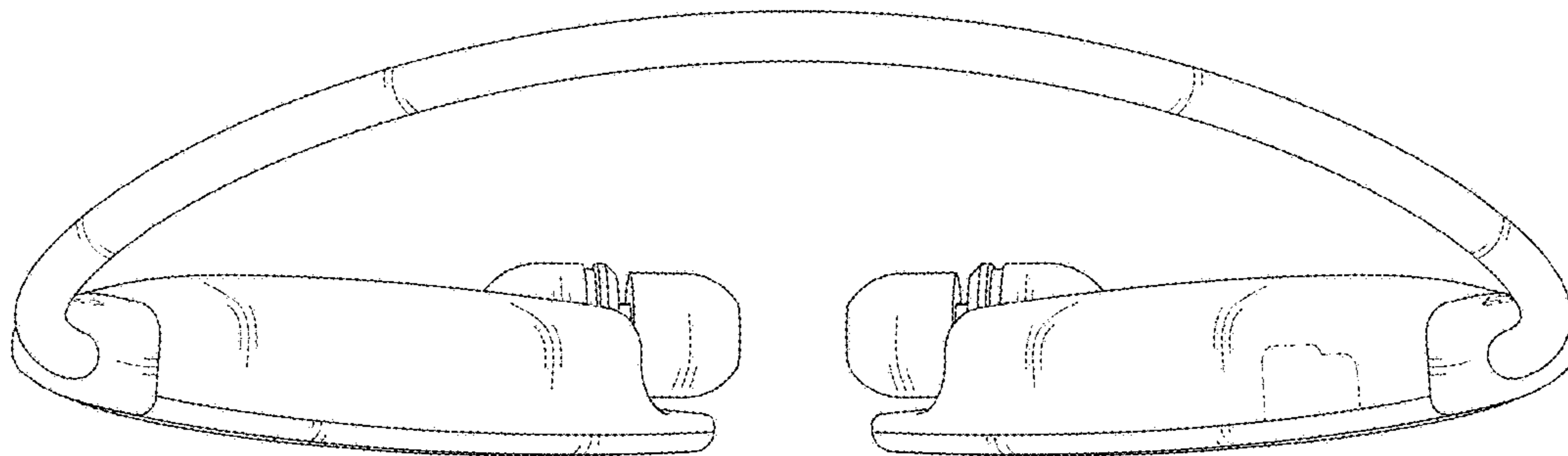

FIG. 6

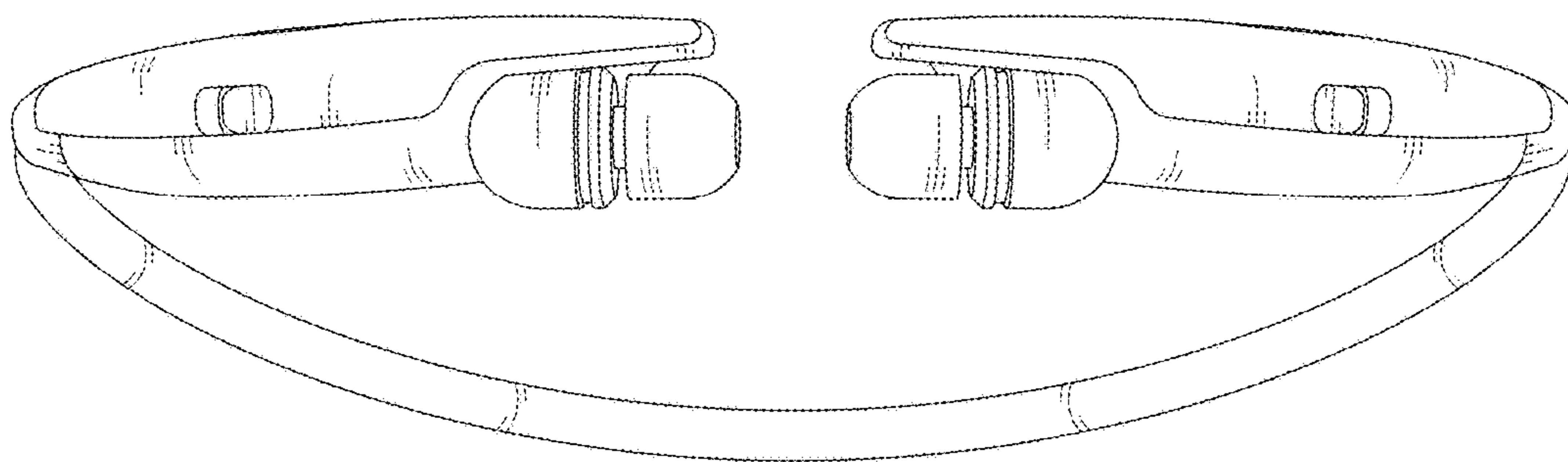

FIG. 7

