



US00D772842S

(12) **United States Design Patent**  
**Sharp et al.**

(10) **Patent No.:** **US D772,842 S**

(45) **Date of Patent:** **\*\* Nov. 29, 2016**

(54) **HEADSET WITH MICROPHONE**

(71) Applicant: **Logitech Europe S.A.**, Lausanne (CH)

(72) Inventors: **Douglas Paul Sharp**, San Francisco, CA (US); **Cormac O’Conaire**, Cabinteely (IE); **James Rennick**, Dublin (IE)

(73) Assignee: **LOGITECH EUROPE S.A.**, Lausanne (CH)

(\*\*) Term: **15 Years**

(21) Appl. No.: **29/533,975**

(22) Filed: **Jul. 23, 2015**

(51) **LOC (10) Cl.** ..... **14-01**

(52) **U.S. Cl.**  
USPC ..... **D14/205**

(58) **Field of Classification Search**  
USPC ..... D14/205, 225, 206, 188, 192; D29/112, D29/122, 117.2; 2/209; 181/129, 130, 135; 379/430, 431; 381/74, 380, 381, 370, 381/374, 378, 183, 187, 327, 385, 379; 455/90.3, 575.2  
CPC ..... H04R 1/1066; H04R 25/00; H04R 1/10; H04R 1/105  
See application file for complete search history.

(56) **References Cited**

**U.S. PATENT DOCUMENTS**

D103,525 S *	3/1937	Bloch	.....	D5/54
2,139,512 A *	12/1938	Nagorny	.....	A44C 15/00 428/52
D195,960 S *	8/1963	Spilman	.....	D14/225
D222,361 S *	10/1971	Hart	.....	D14/205
3,984,885 A *	10/1976	Yoshimura	.....	H04R 5/033 381/19
D254,183 S *	2/1980	Doodson	.....	D14/205
D286,632 S *	11/1986	Teunis	.....	D14/205
D299,337 S *	1/1989	Wiegel	.....	D14/206
4,821,318 A *	4/1989	Wu	.....	H04M 1/05 379/430

D302,429 S *	7/1989	Leer	.....	D14/137
D313,092 S *	12/1990	Nilsson	.....	D14/205
5,068,923 A *	12/1991	Sjoqvist	.....	A61F 11/14 181/129

(Continued)

*Primary Examiner* — Paula Greene

(74) *Attorney, Agent, or Firm* — Patterson & Sheridan LLP

(57) **CLAIM**

The ornamental design for a headset with a microphone, as shown and described.

**DESCRIPTION**

FIG. 1 is a top front perspective view of a headset with a microphone in an extended position showing our new design;

FIG. 2 is a bottom rear perspective view thereof;

FIG. 3 another top front perspective view thereof;

FIG. 4 is another bottom rear perspective view thereof;

FIG. 5 is a front elevational view thereof;

FIG. 6 is a right side elevational view thereof;

FIG. 7 is a rear elevational view thereof;

FIG. 8 is a left side elevational view thereof;

FIG. 9 is a top plan view thereof;

FIG. 10 is a bottom plan view thereof;

FIG. 11 is a top front perspective view of the headset with the microphone in a retracted position;

FIG. 12 is a bottom rear perspective view thereof;

FIG. 13 another top front perspective view thereof;

FIG. 14 is another bottom rear perspective view thereof;

FIG. 15 is a front elevational view thereof;

FIG. 16 is a right side elevational view thereof;

FIG. 17 is a rear elevational view thereof;

FIG. 18 is a left side elevational view thereof;

FIG. 19 is a top plan view thereof;

FIG. 20 is a bottom plan view thereof;

FIG. 21 is a top front perspective view of the headset with the microphone in a fully extended position;

FIG. 22 is a bottom rear perspective view thereof;

FIG. 23 is a right side elevational view thereof;

FIG. 24 is a left side elevational view thereof;

FIG. 25 is a top plan view thereof; and,

FIG. 26 is a bottom plan view thereof.

**1 Claim, 25 Drawing Sheets**

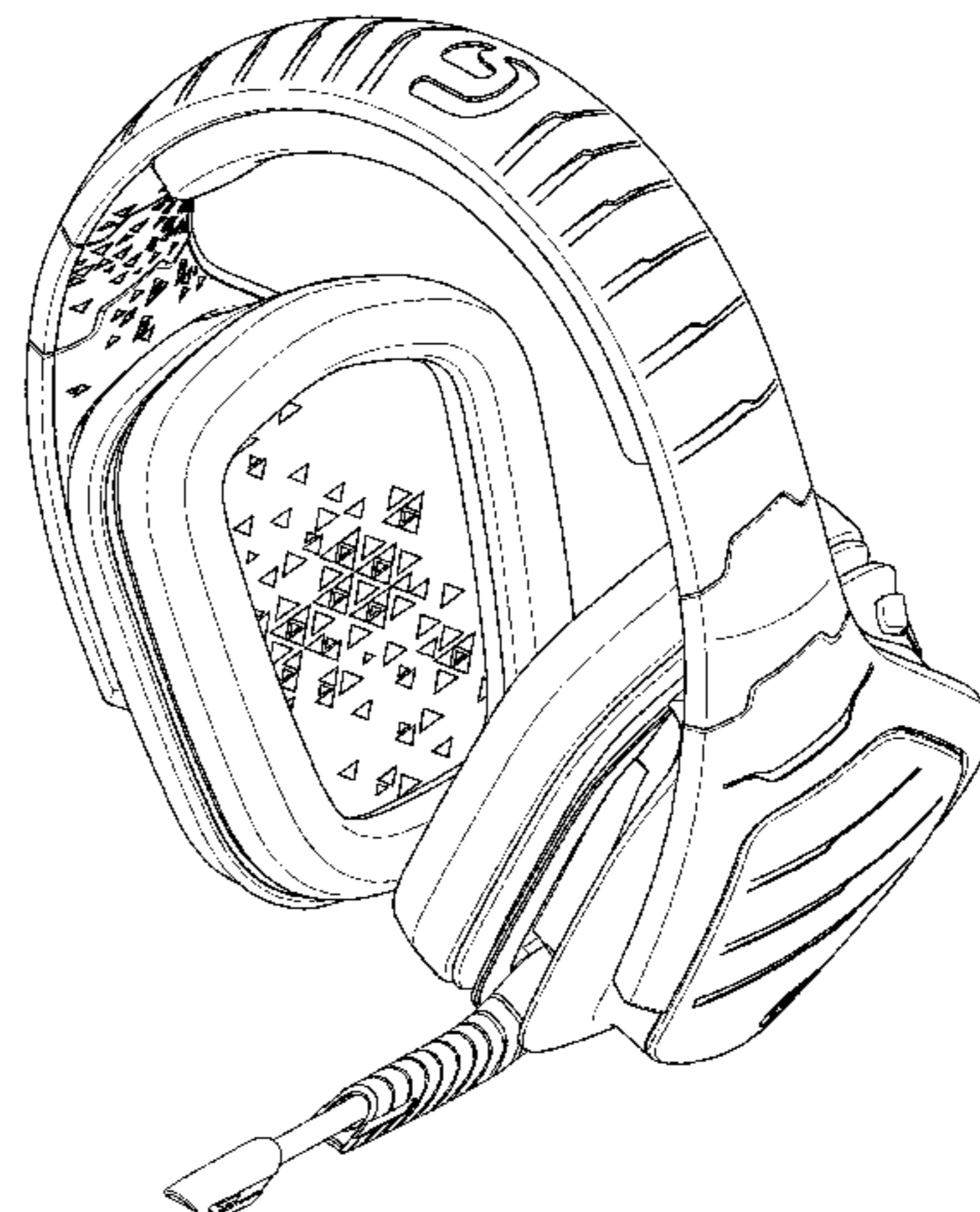

(56)

References Cited

U.S. PATENT DOCUMENTS

5,113,428	A *	5/1992	Fitzgerald	.....	H04B 1/3816 379/430
D327,888	S *	7/1992	Fitzgerald	.....	D14/138 R
D333,137	S *	2/1993	Burke	.....	D14/206
5,185,807	A *	2/1993	Bergin	.....	H04R 1/1066 181/128
D345,981	S *	4/1994	Burke	.....	D14/206
D346,380	S *	4/1994	Fitzgerald	.....	D14/138 R
D357,477	S *	4/1995	Mueller	.....	D14/206
D358,390	S *	5/1995	Hayashi	.....	D14/205
5,793,865	A *	8/1998	Leifer	.....	H04M 1/05 379/430
5,794,127	A *	8/1998	Lansang	.....	H04R 1/1041 340/12.5
D406,140	S *	2/1999	Hall	.....	D14/205
D411,200	S *	6/1999	Almqvist	.....	D14/192
D418,509	S *	1/2000	Zeitman	.....	D14/192
D443,603	S *	6/2001	Taylor	.....	D14/206
D456,379	S *	4/2002	Fitzgerald	.....	D14/142
D491,917	S *	6/2004	Asai	.....	D14/205
D497,608	S *	10/2004	Birgersson	.....	D14/205
D520,492	S *	5/2006	Chen	.....	D14/205
D542,774	S *	5/2007	Rausch	.....	D14/206
D566,688	S *	4/2008	Wang	.....	D14/206
D576,604	S *	9/2008	Suzuki	.....	D14/205
D589,492	S *	3/2009	Mistry	.....	D14/205
D592,639	S *	5/2009	Kuh	.....	D14/205
D613,266	S *	4/2010	Barry	.....	D14/205
D628,554	S *	12/2010	Tedja	.....	D14/205
D641,727	S *	7/2011	Krauss	.....	D14/206
D652,017	S *	1/2012	Groves	.....	D14/206
D658,629	S *	5/2012	Nomura	.....	D14/205
D658,630	S *	5/2012	Gondo	.....	D14/205
D672,745	S *	12/2012	Abed	.....	D14/205
D689,464	S *	9/2013	Bonahoom	.....	D14/206
D691,111	S *	10/2013	Lee	.....	D14/206
D691,582	S *	10/2013	Nguyen	.....	D14/205
D693,327	S *	11/2013	Chiu	.....	D14/206
D699,216	S *	2/2014	Bonahoom	.....	D14/205
D707,654	S *	6/2014	Nguyen	.....	D14/205
D716,762	S *	11/2014	Greve	.....	D14/206
D729,196	S *	5/2015	Liu	.....	D14/205
9,036,849	B2 *	5/2015	Thompson	.....	H04R 1/083 381/122
D733,091	S *	6/2015	Heinonen	.....	D14/205
D739,843	S *	9/2015	Daniel	.....	D14/205
D741,286	S *	10/2015	Brennwald	.....	D14/205
D745,860	S *	12/2015	Logan	.....	D14/206
D746,793	S *	1/2016	Logan	.....	D14/206
2001/0017925	A1 *	8/2001	Ceravolo	.....	H04M 1/05 381/370
2007/0223766	A1 *	9/2007	Davis	.....	H04M 1/05 381/379
2011/0194721	A1 *	8/2011	Schmidt	.....	H04R 1/1066 381/370

\* cited by examiner



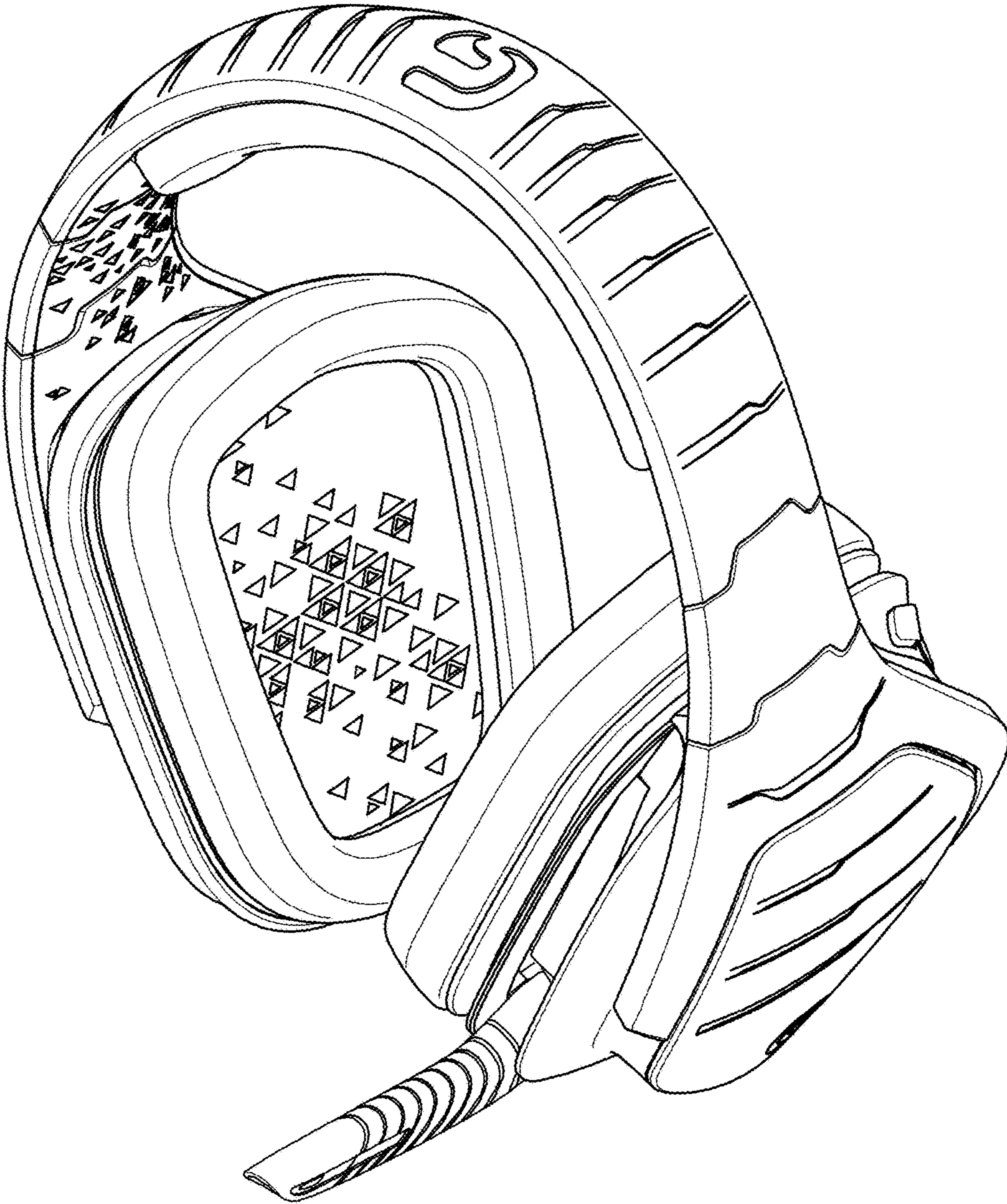

Fig. 1

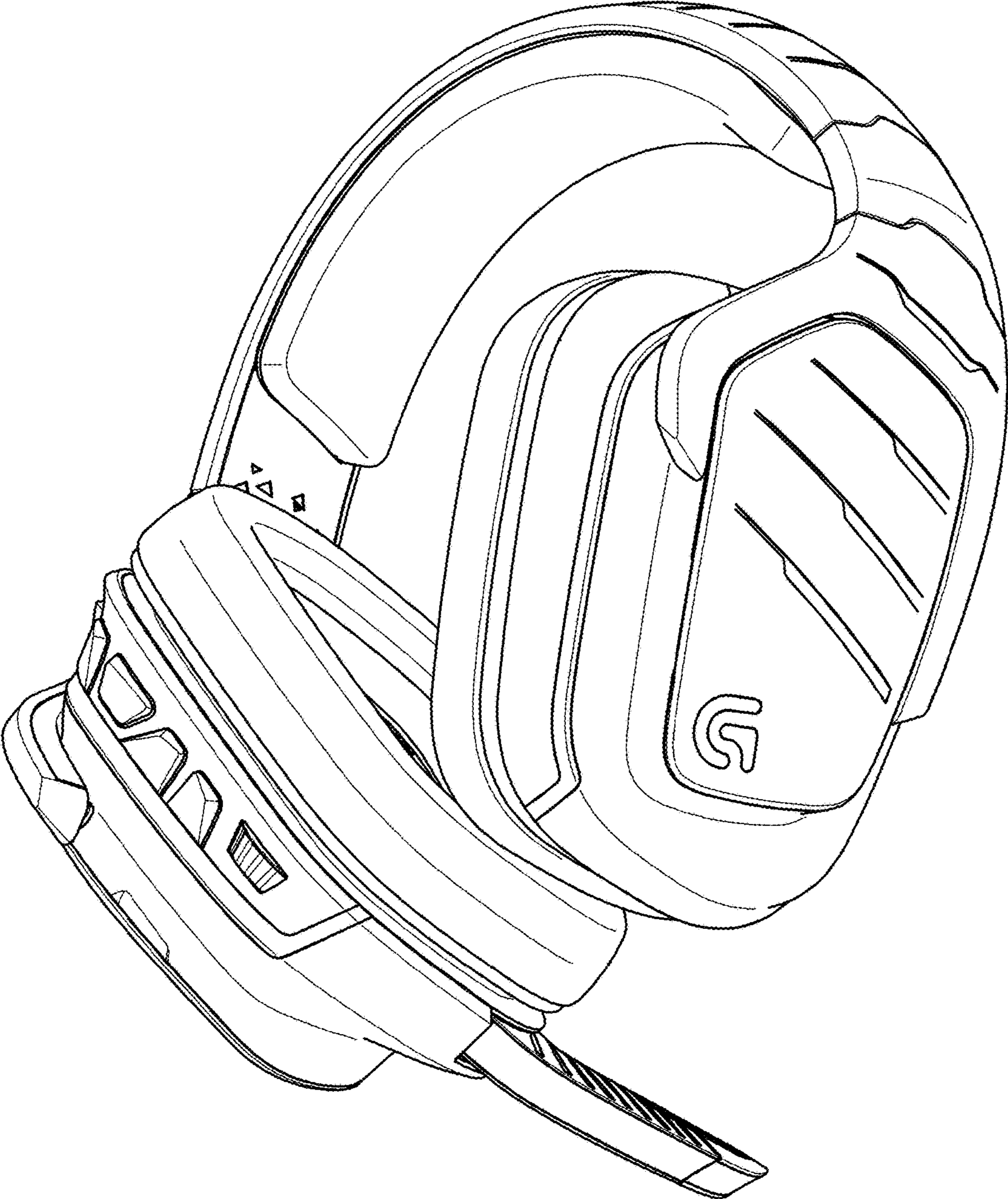

Fig. 2

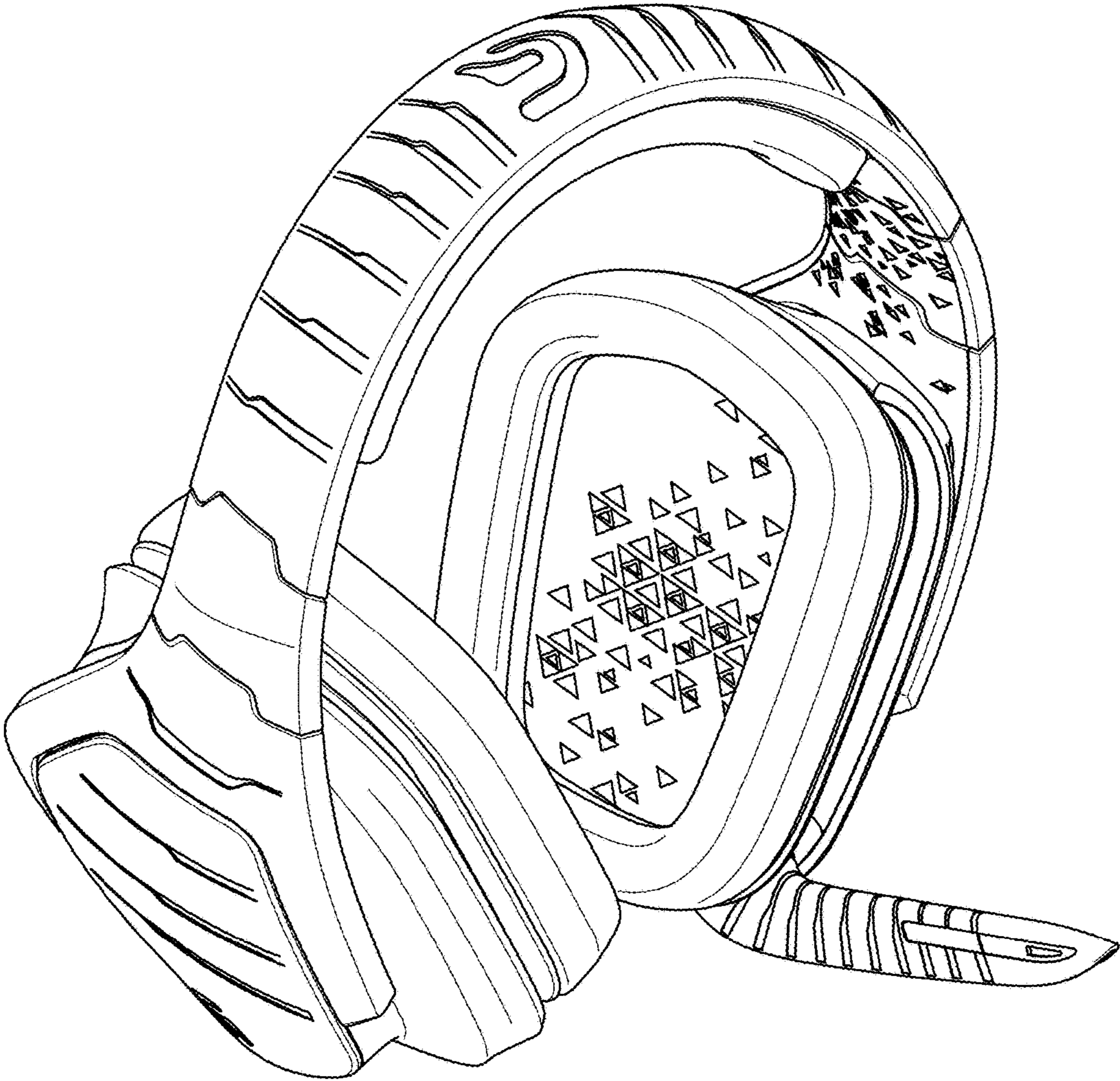

Fig. 3





Fig. 4



Fig. 5



*Fig. 6*

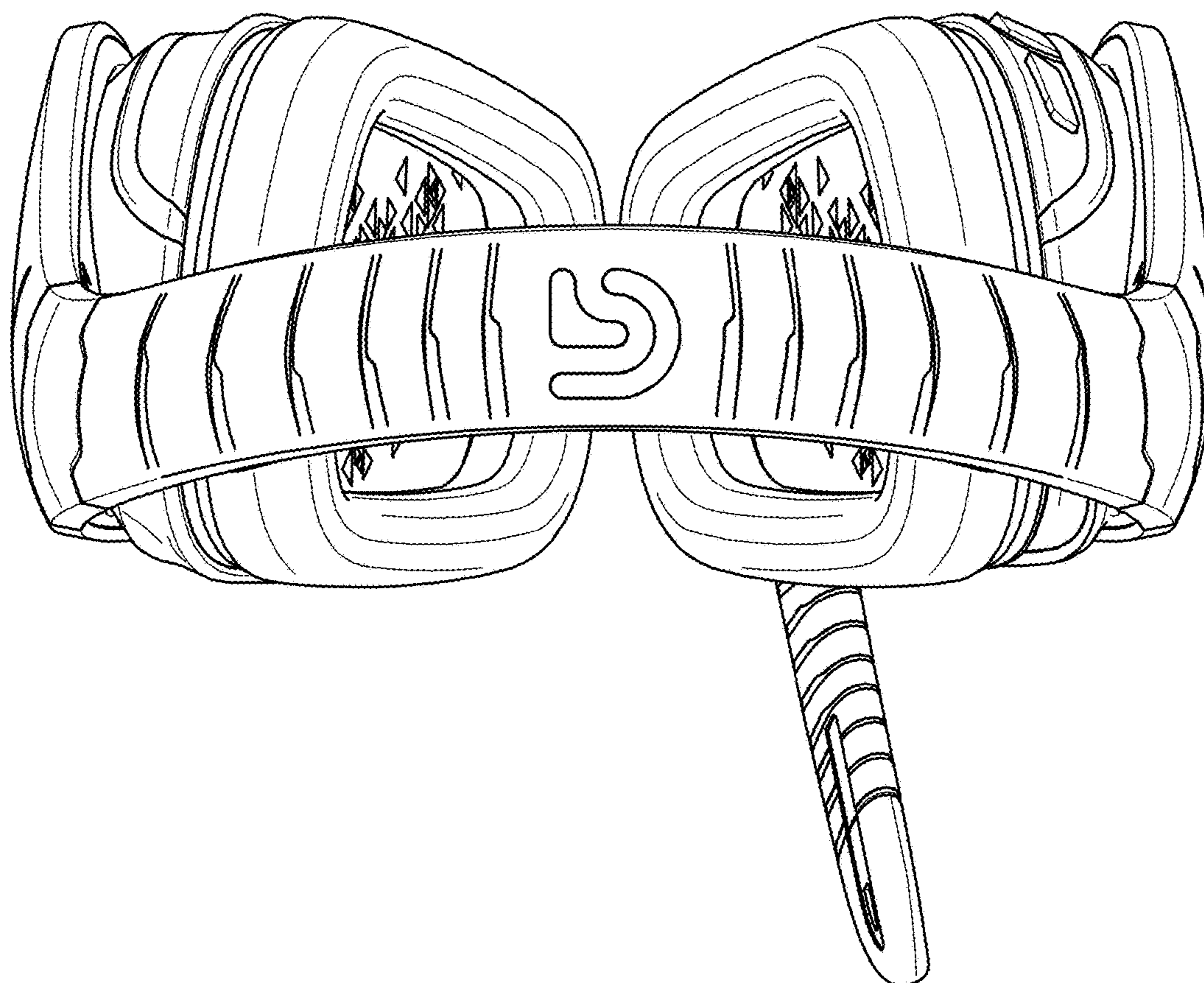



Fig. 7

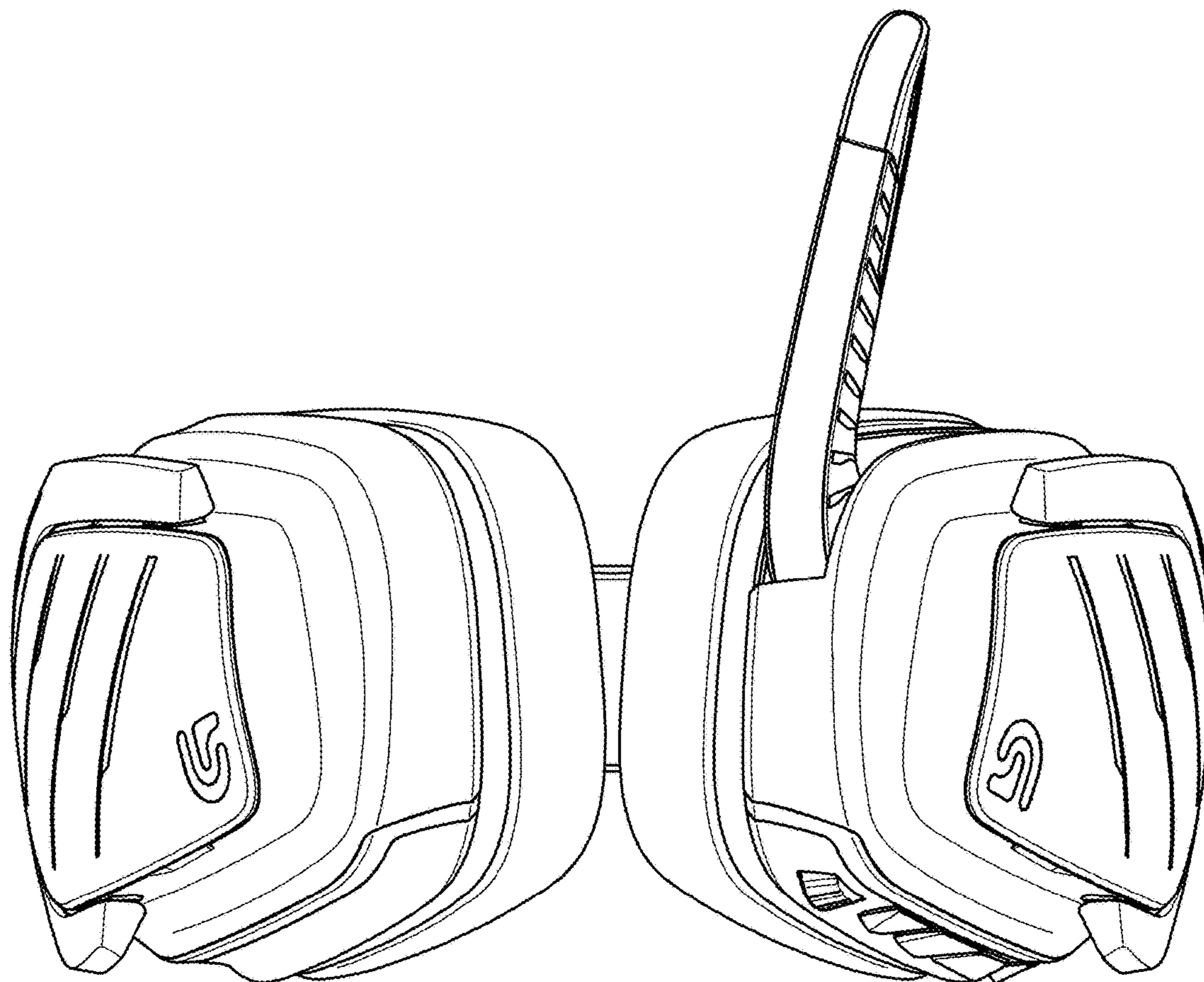

*Fig. 8*



*Fig. 9*





*Fig. 10*

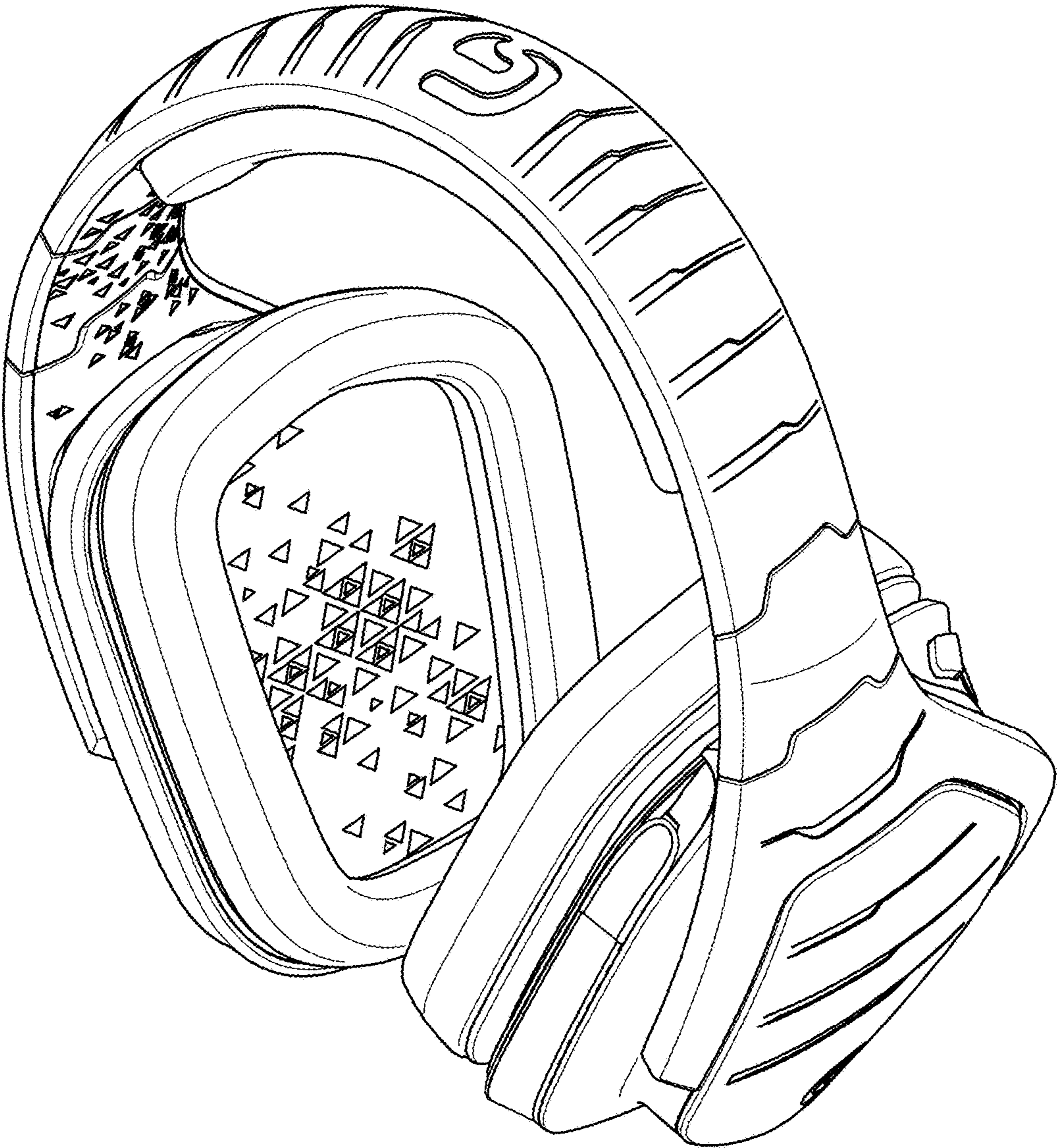
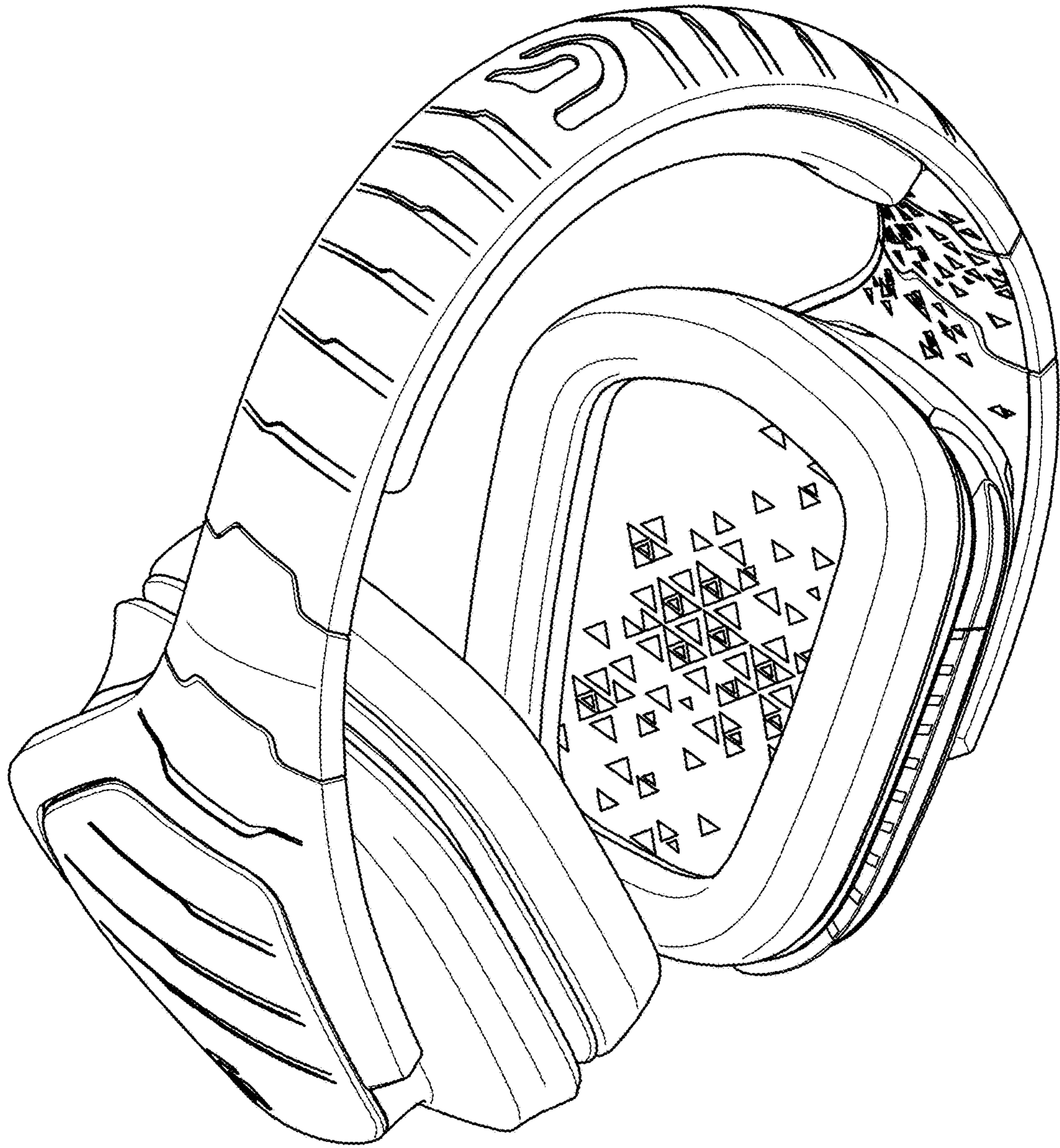

Fig. 11



*Fig. 12*





*Fig. 13*

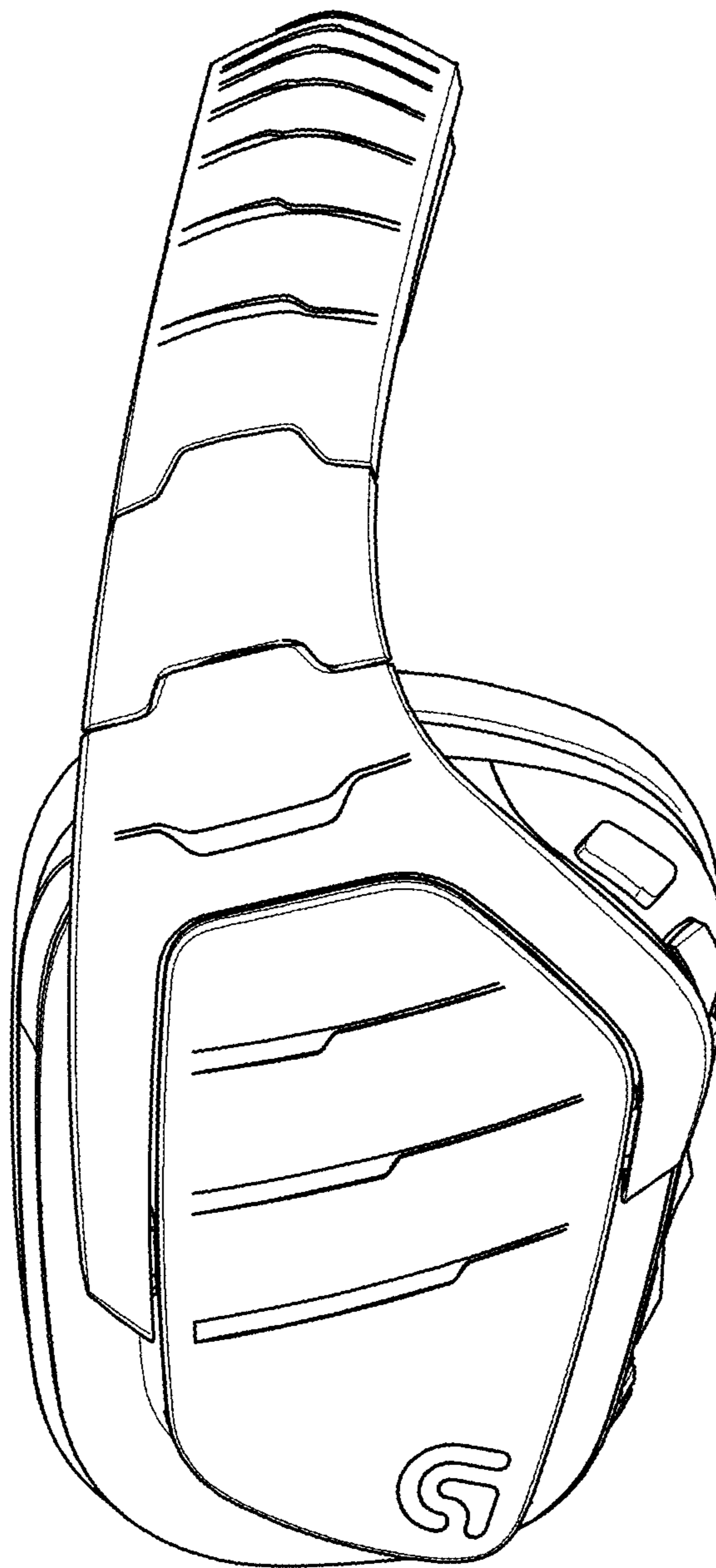

Fig. 14



*Fig. 15*

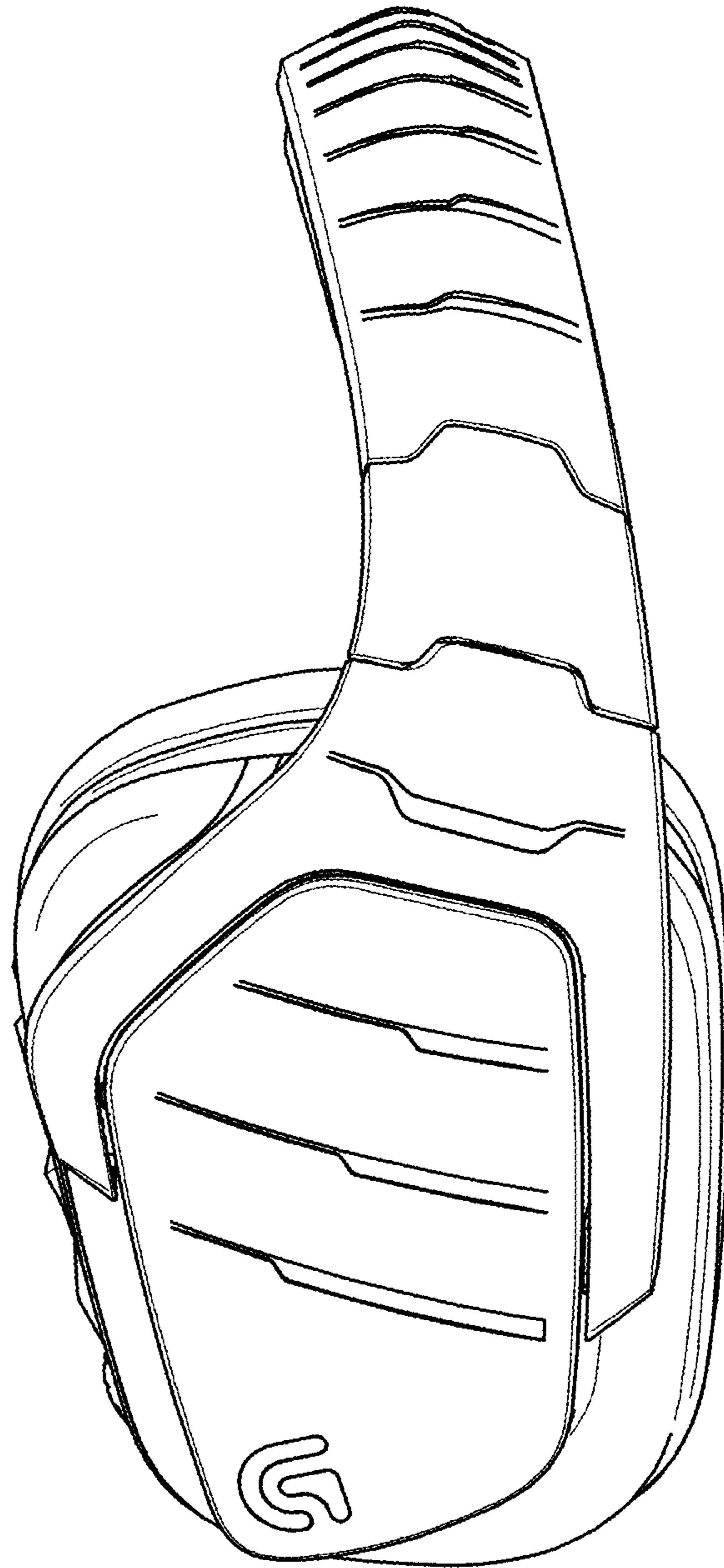



*Fig. 16*

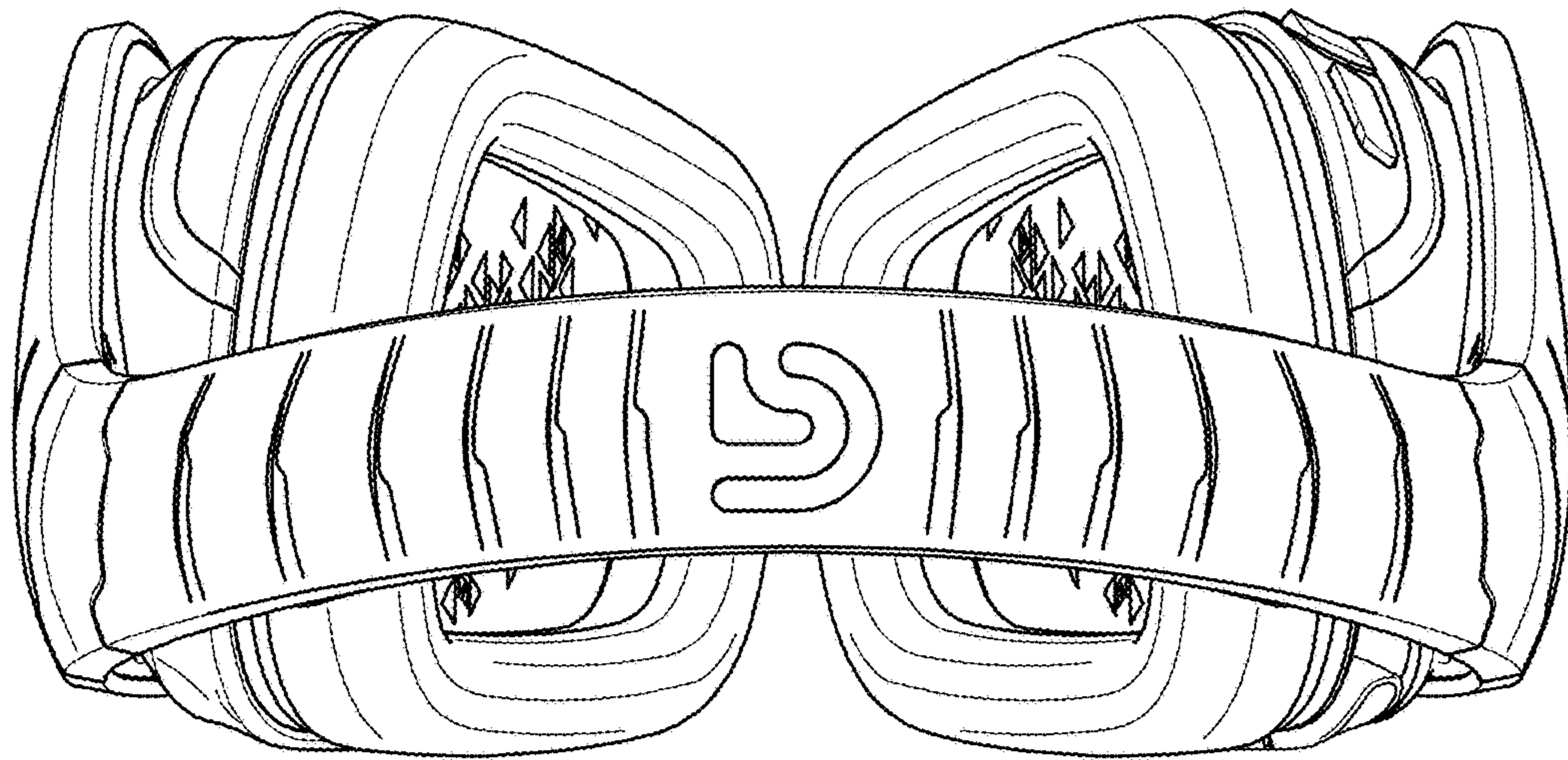

*Fig. 17*

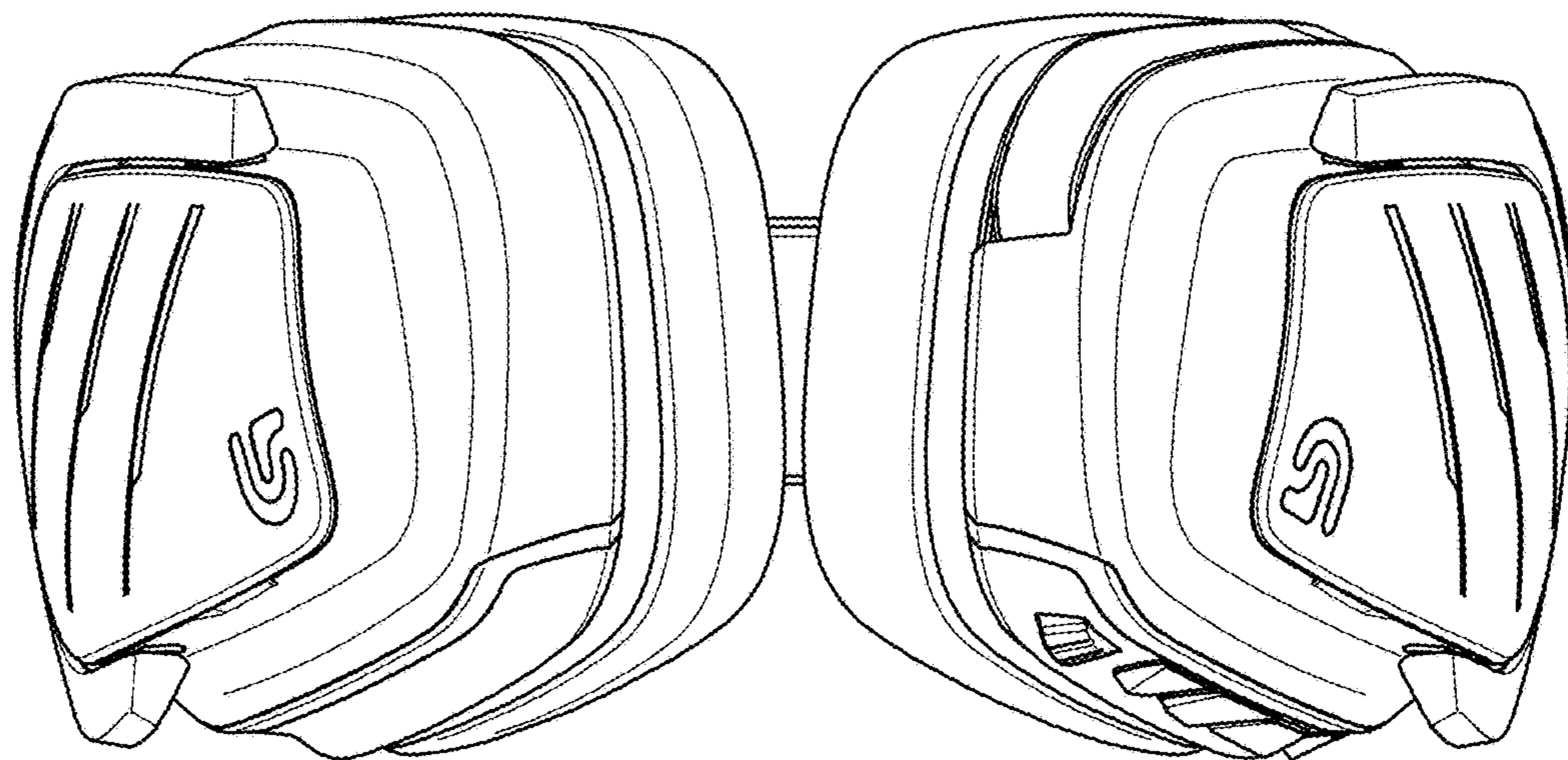

*Fig. 18*





*Fig. 19*



*Fig. 20*

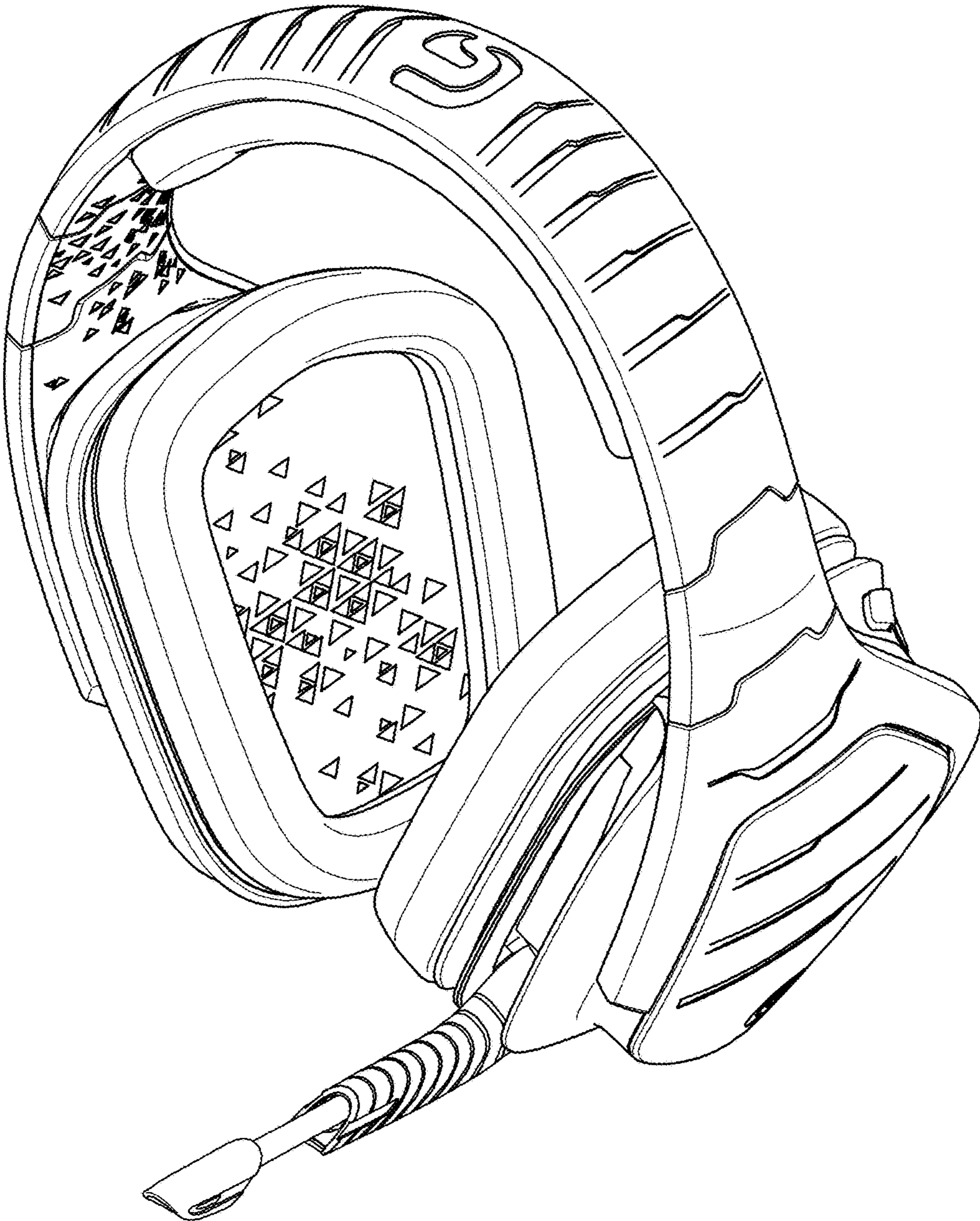

Fig. 21





*Fig. 22*



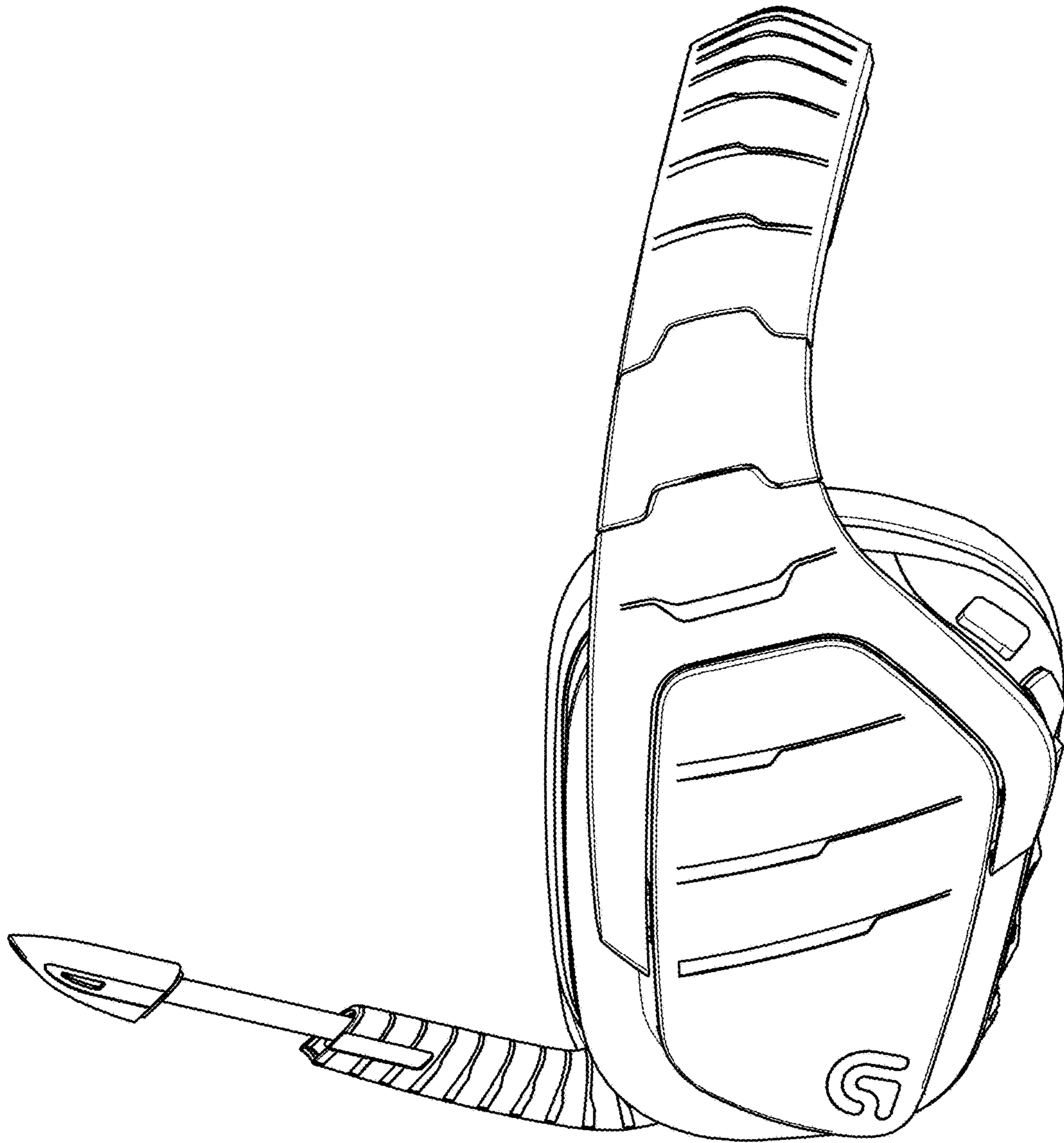
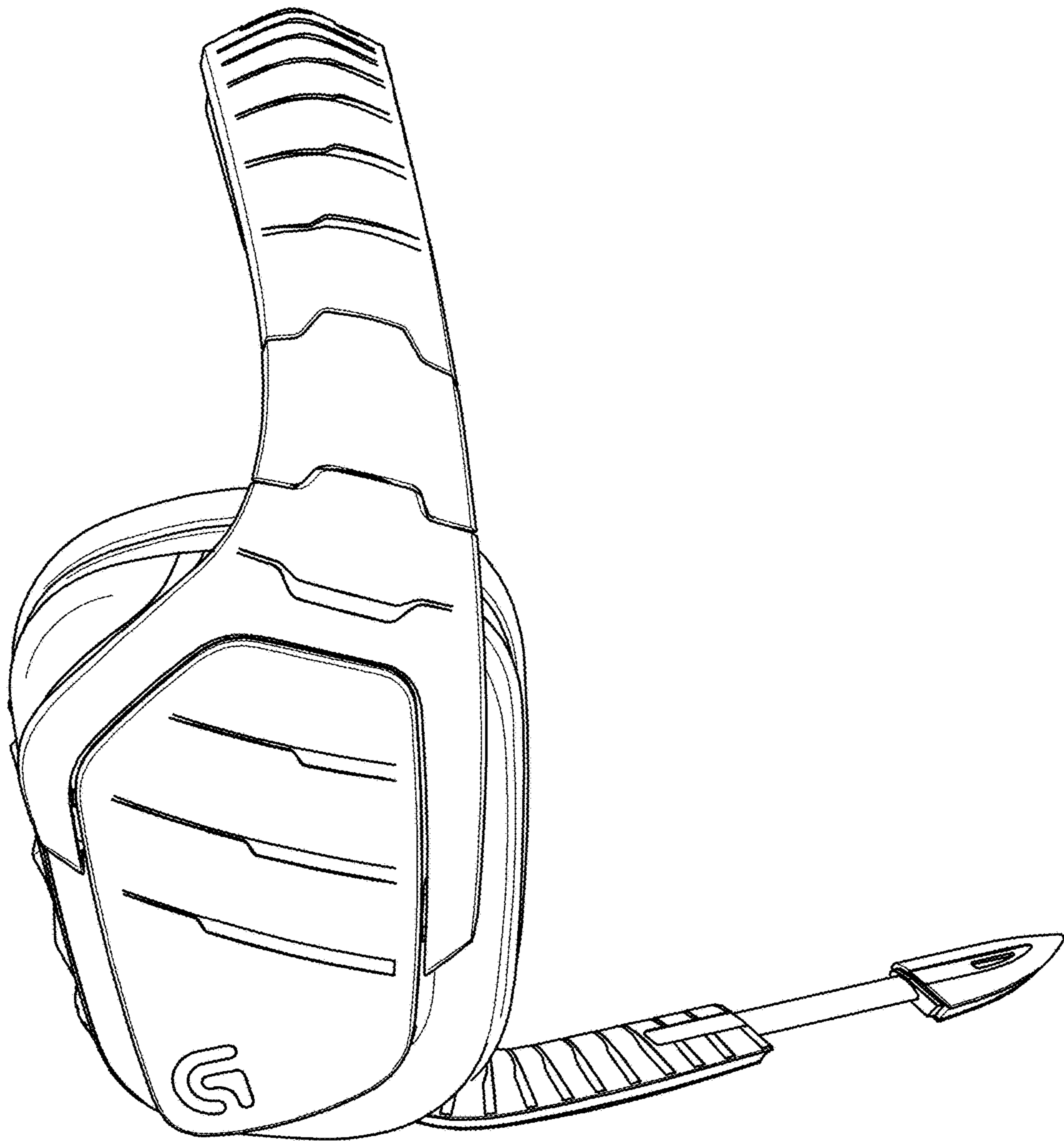
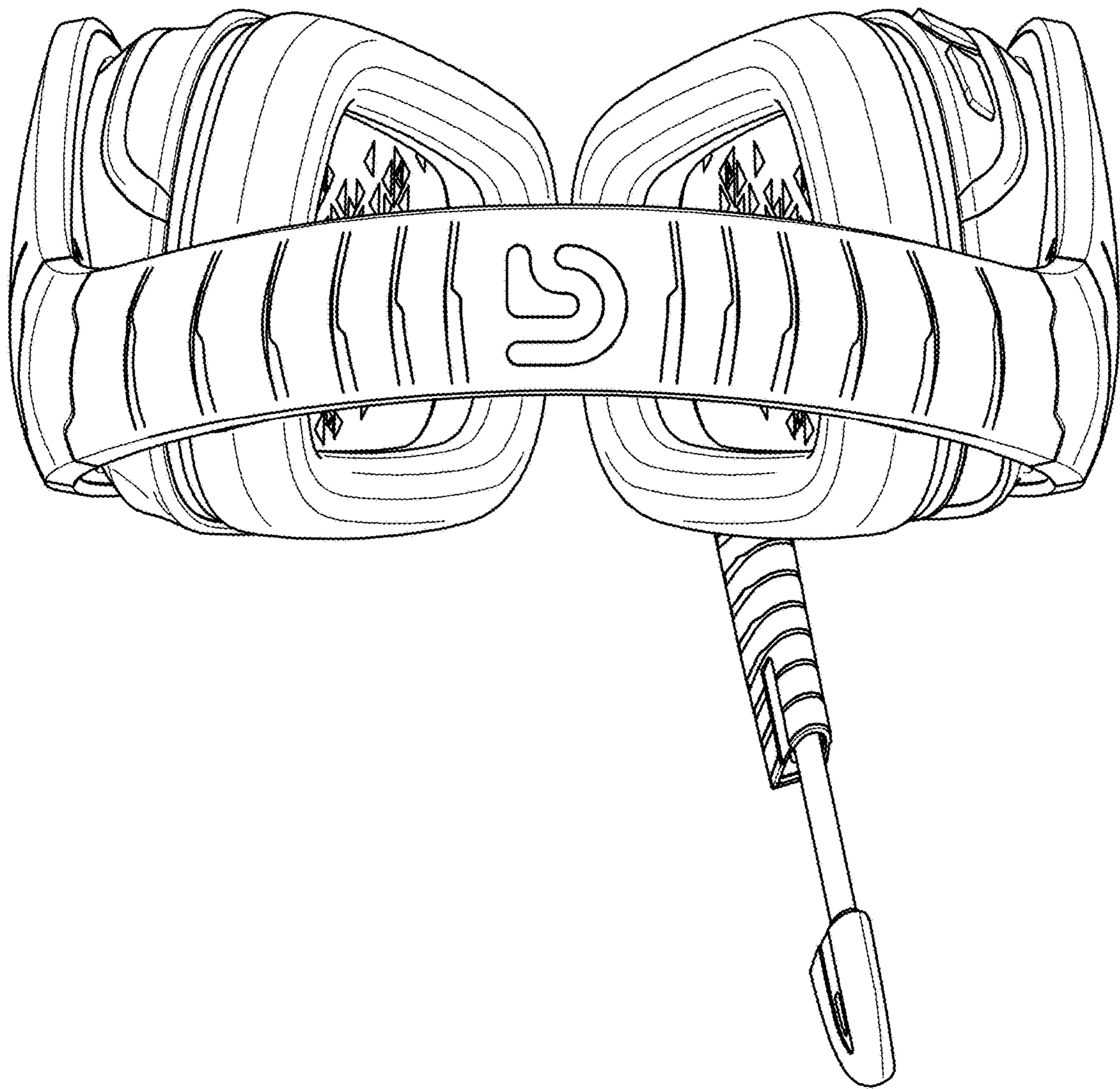

Fig. 23

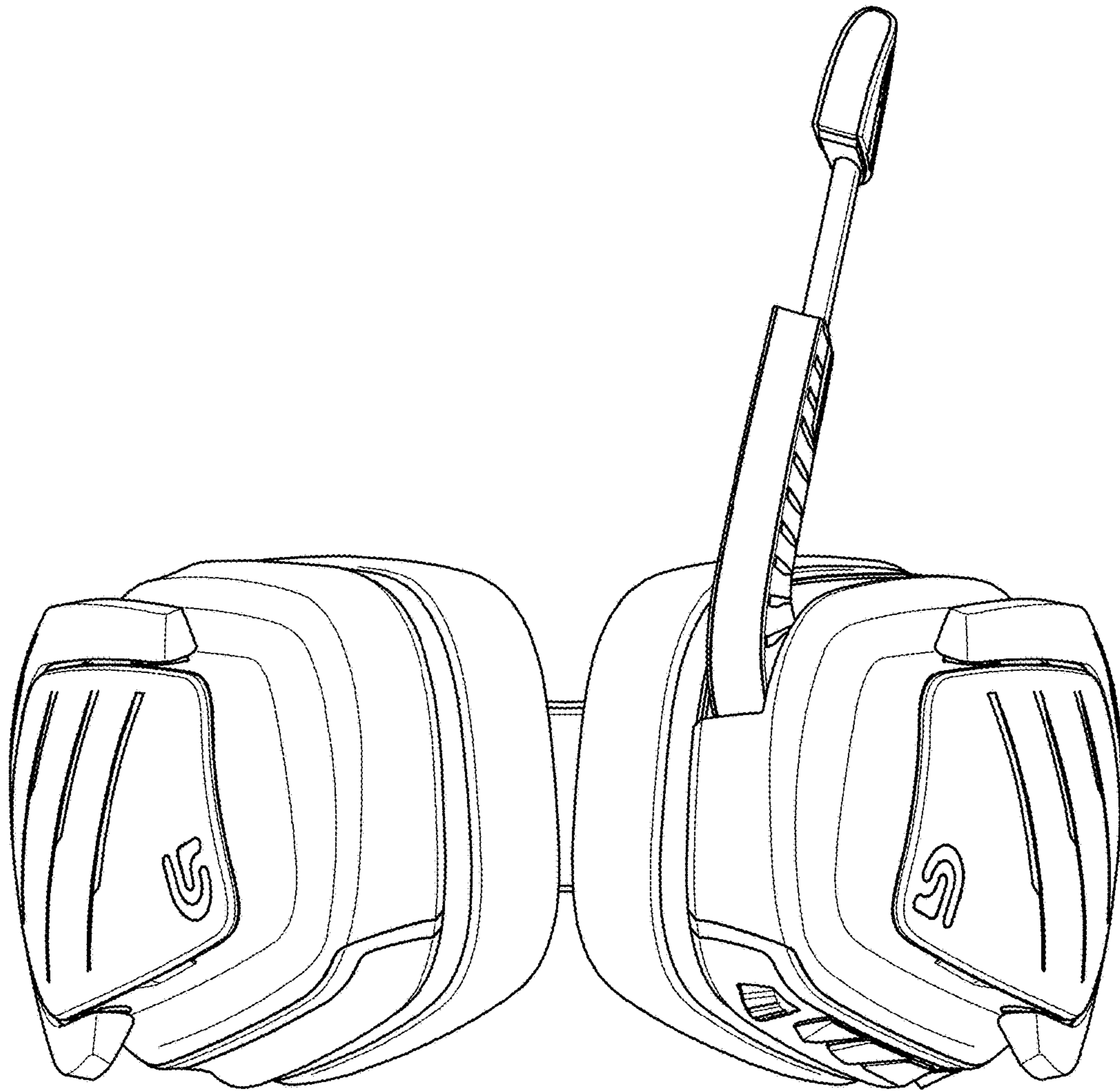

*Fig. 24*



*Fig. 25*





*Fig. 26*