



US00D772835S

(12) **United States Design Patent**
Kim et al.

(10) **Patent No.:** **US D772,835 S**

(45) **Date of Patent:** **** Nov. 29, 2016**

(54) **CELLULAR PHONE**

(71) Applicant: **LG ELECTRONICS INC.**, Seoul
(KR)

(72) Inventors: **Byeongwook Kim**, Seoul (KR); **Hyon Kim**, Seoul (KR); **Youngho Kim**, Seoul
(KR)

(73) Assignee: **LG ELECTRONICS INC.**, Seoul
(KR)

(**) Term: **14 Years**

(21) Appl. No.: **29/503,398**

(22) Filed: **Sep. 25, 2014**

(30) **Foreign Application Priority Data**

Mar. 26, 2014 (KR) 30-2014-0015025

(51) **LOC (10) Cl.** **14-03**

(52) **U.S. Cl.**
USPC **D14/138 AB**

(58) **Field of Classification Search**

USPC D14/138 AA, 138 AB, 138 AD, 138 G,
D14/138 R, 341, 345, 203.7, 248, 496;
D10/65; 361/679.27

CPC .. G06F 1/1652; G06F 1/1616; G06F 1/1618;
G06F 1/1624; H04M 1/0222; H04M 1/0254;
H04M 1/0256

See application file for complete search history.

(56) **References Cited**

U.S. PATENT DOCUMENTS

D543,183 S * 5/2007 Cho D14/138 AA
D545,843 S * 7/2007 Song D14/496
D547,295 S * 7/2007 Park D14/138 AB

(Continued)

OTHER PUBLICATIONS

Samsung, Flexible OLED Phone, as posted at Inhabit [online],
posted on Nov. 7, 2011 [site visited Jul. 28, 2016] Available from the
Internet, <URL: <http://inhabitat.com/samsung-to-launch-flexible-oled-cell-phone-next-year/>>.*

(Continued)

Primary Examiner — Jeffrey D Asch

Assistant Examiner — Rebekah A Caruso

(74) *Attorney, Agent, or Firm* — Birch, Stewart, Kolasch
& Birch, LLP

(57) **CLAIM**

The ornamental design for a cellular phone, as shown and
described.

DESCRIPTION

FIG. 1 is a front, right side, perspective view of a cellular
phone showing our new design;

FIG. 2 is a front view thereof;

FIG. 3 is a rear view thereof;

FIG. 4 is a left side view thereof;

FIG. 5 is a right side view thereof;

FIG. 6 is a top view thereof;

FIG. 7 is a bottom view thereof;

FIG. 8 is a front, right side, perspective view in an open state
thereof;

FIG. 9 is a front view in an open state thereof;

FIG. 10 is a rear view in an open state thereof;

FIG. 11 is a left side view in an open state thereof;

FIG. 12 is a right side view in an open state thereof;

FIG. 13 is a top view in an open state thereof; and,

FIG. 14 is a bottom view in an open state thereof.

The broken lines shown in the figures that are immediately
adjacent to the shaded areas and define unshaded regions
represent the bounds of the claim. All other broken lines, i.e.
the features within broken line boundaries, are directed to
environment. The broken lines form no part of the claimed
design.

1 Claim, 13 Drawing Sheets

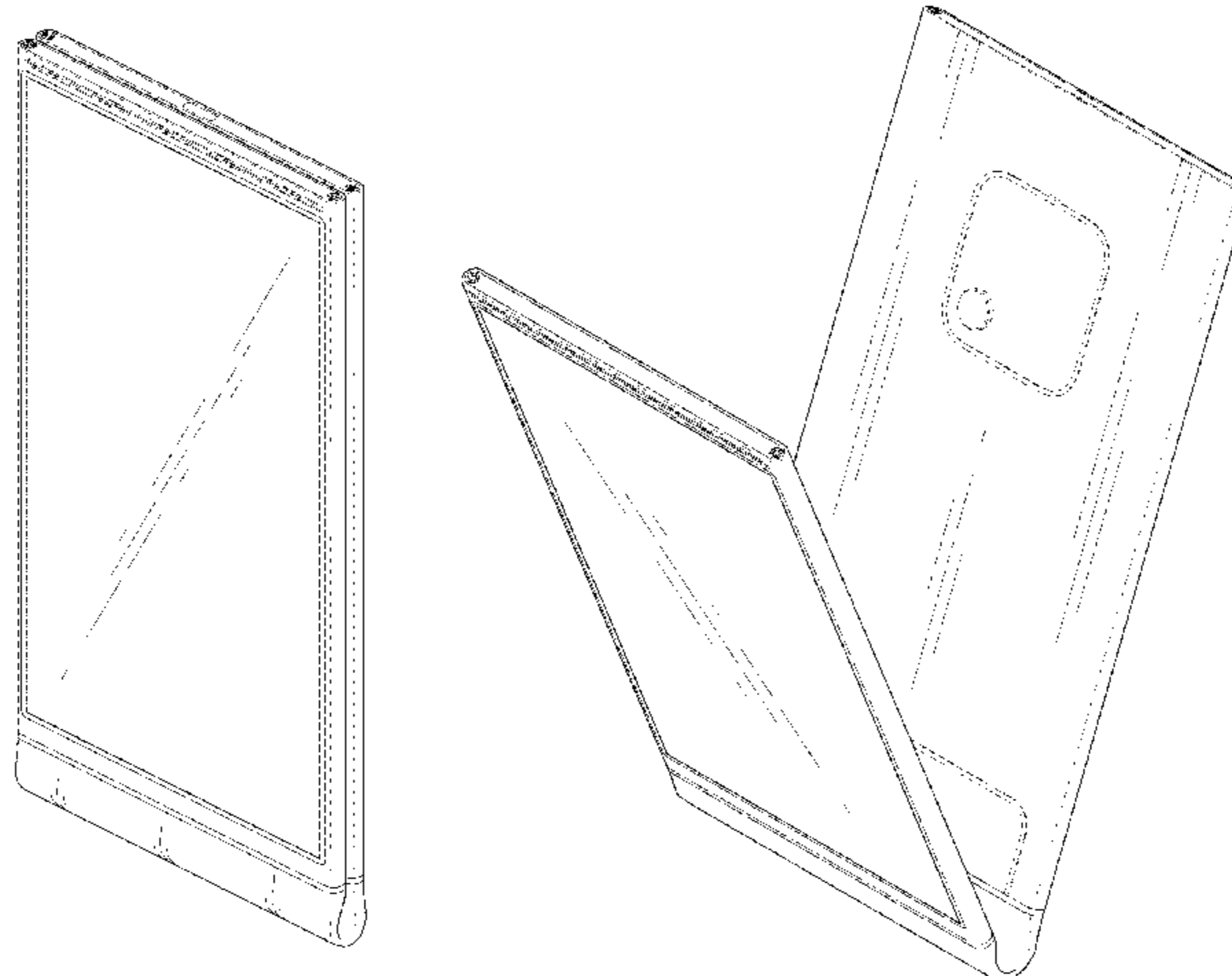

(56)

References Cited

U.S. PATENT DOCUMENTS

D579,906 S * 11/2008 Kim D14/138 AB
 D601,110 S * 9/2009 Chang D14/138 AD
 D603,363 S * 11/2009 Choi D14/138 AB
 D614,602 S * 4/2010 Yoo D14/203.7
 D615,057 S * 5/2010 Kim D14/138 AB
 D676,008 S * 2/2013 Park D14/138 G
 D718,266 S * 11/2014 Zhang D14/138 G
 D718,268 S * 11/2014 Wu D14/138 G
 D746,250 S * 12/2015 Chu D14/138 G
 D749,573 S * 2/2016 Park D14/203.4
 9,298,221 B2 * 3/2016 Choi G06F 1/1677
 D753,088 S * 4/2016 Wu D14/138 G
 2014/0126133 A1 * 5/2014 Griffin G06F 1/1652
 361/679.27
 2014/0226275 A1 * 8/2014 Ko G06F 1/1626
 361/679.27
 2014/0362513 A1 * 12/2014 Nurmi G06F 1/1652
 361/679.27
 2015/0185782 A1 * 7/2015 Kim G06F 1/1652
 349/12
 2015/0193036 A1 * 7/2015 Yoo G06F 3/017
 345/173
 2016/0062412 A1 * 3/2016 Park G06F 1/1656
 361/679.27
 2016/0070306 A1 * 3/2016 Shin G06F 1/1652
 361/679.27

2016/0085268 A1 * 3/2016 Aurongzeb G06F 1/1652
 345/156
 2016/0110010 A1 * 4/2016 Lee G06F 3/0416
 345/173
 2016/0116944 A1 * 4/2016 Lee H04M 1/022
 361/679.26
 2016/0132076 A1 * 5/2016 Bitz G06F 1/1681
 361/679.27
 2016/0139629 A1 * 5/2016 Yeo G06F 1/1624
 361/679.27
 2016/0139634 A1 * 5/2016 Cho G06F 1/1652
 361/679.27
 2016/0147263 A1 * 5/2016 Choi G06F 1/1616
 361/679.3
 2016/0147362 A1 * 5/2016 Eim G06F 1/1641
 345/173
 2016/0195901 A1 * 7/2016 Kauhaniemi G06F 1/1681
 361/679.27

OTHER PUBLICATIONS

Samsung, Foldable Phone, as posted at Concept Phones [online],
 posted on Sep. 18, 2015 [site visited Jul. 28, 2016] Available from
 the Internet, <URL: [http://www.concept-phones.com/samsung/
 samsung-foldable-phone-coming-year-supposedly/](http://www.concept-phones.com/samsung/samsung-foldable-phone-coming-year-supposedly/)>.*

* cited by examiner

FIG. 1

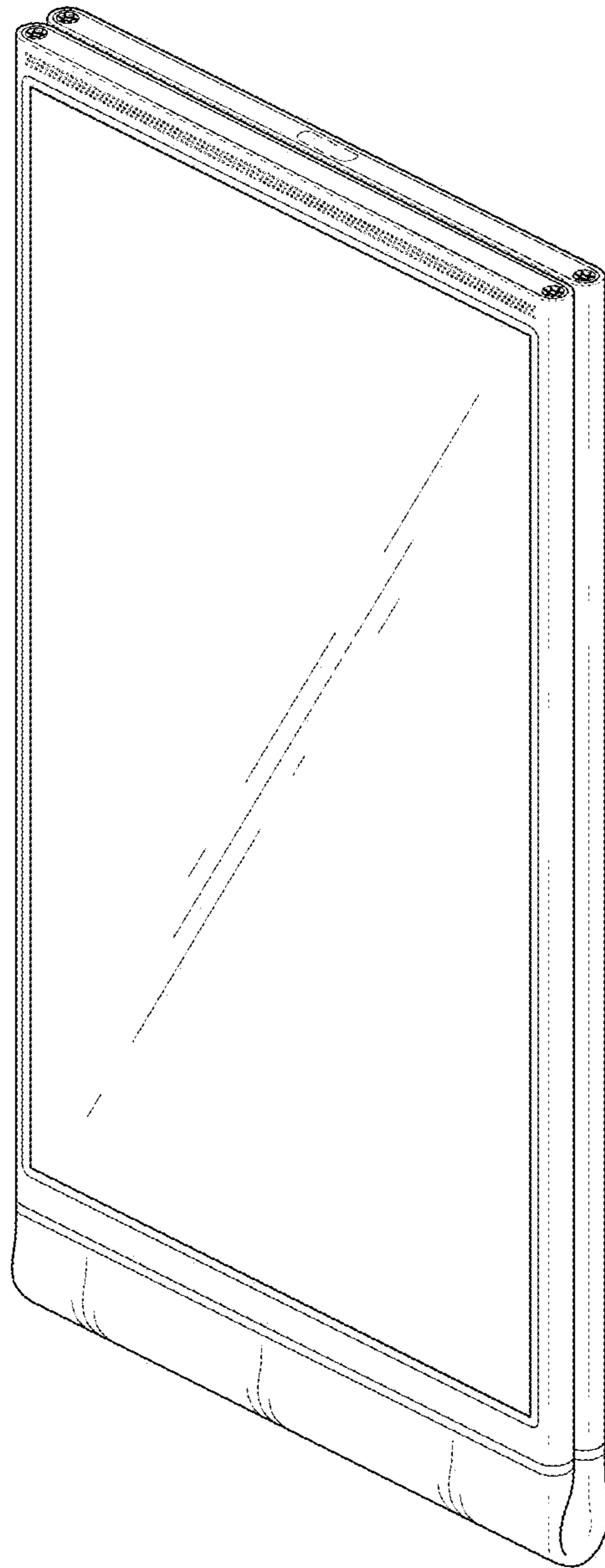

FIG. 2

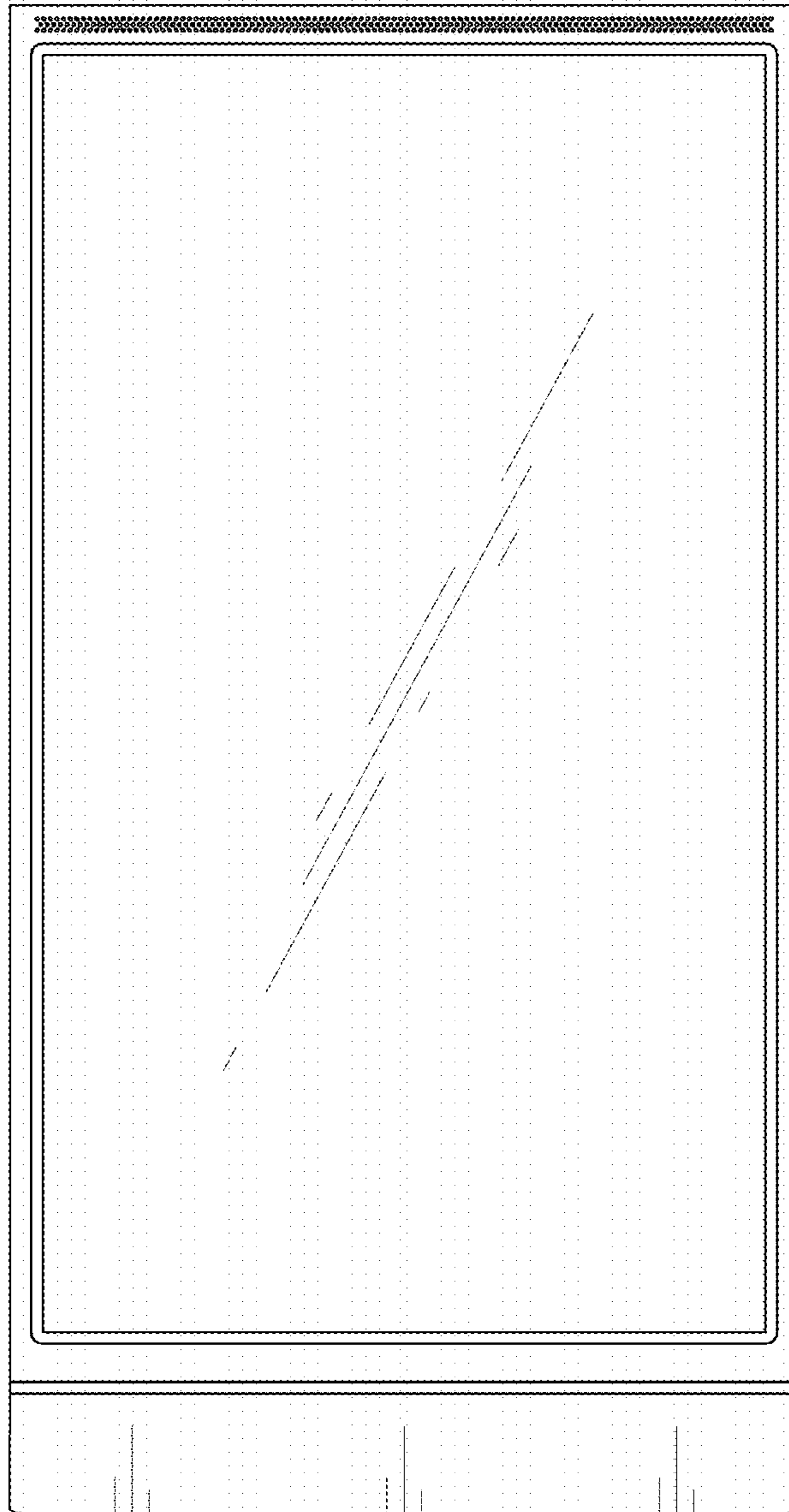

FIG. 3

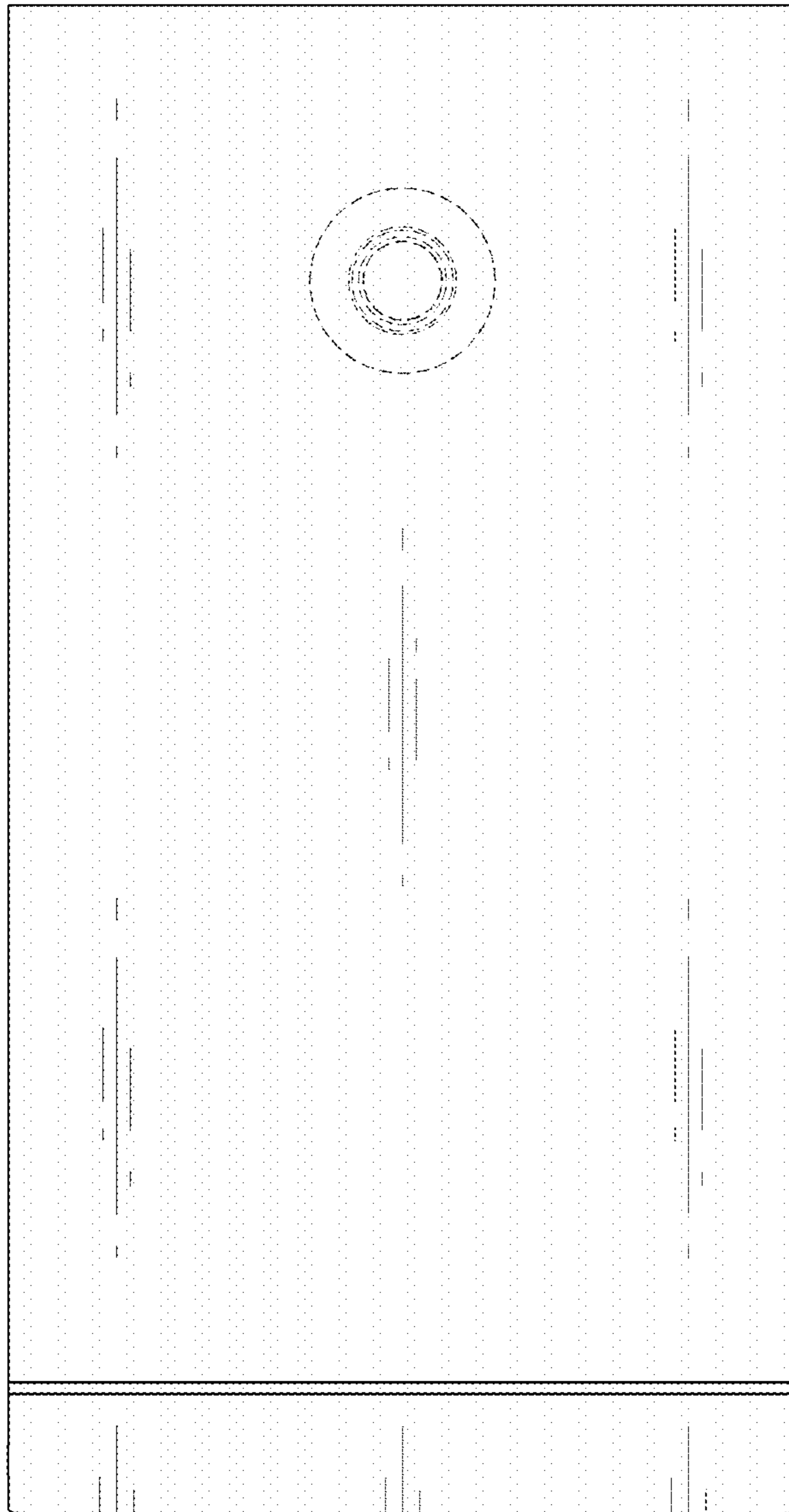

FIG. 4

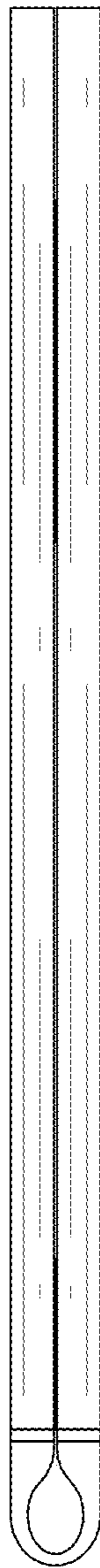

FIG. 5

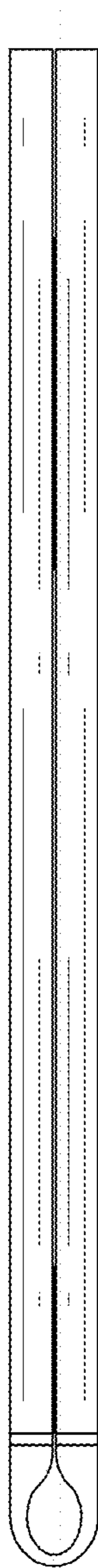

FIG. 6

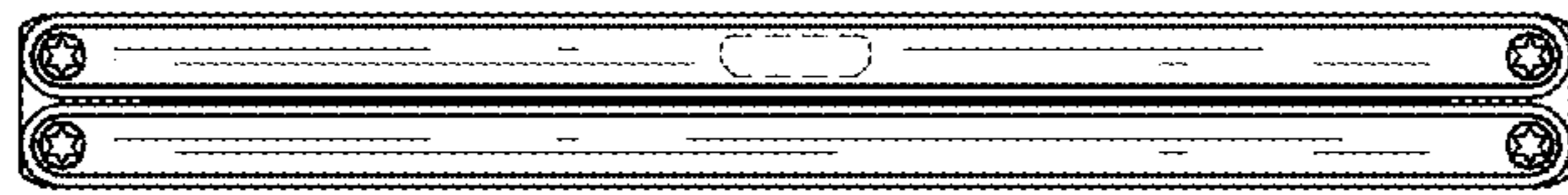

FIG. 7

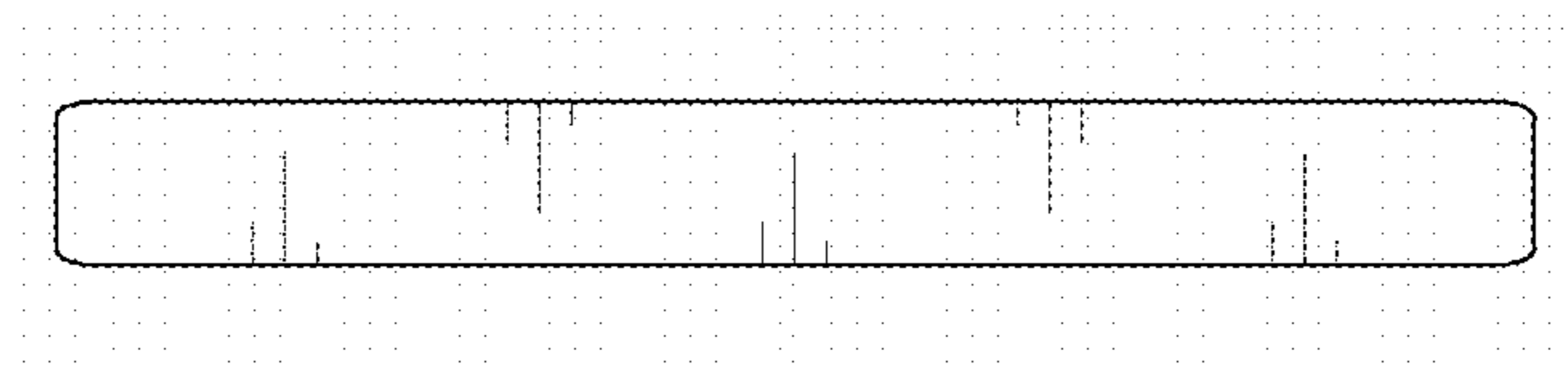

FIG. 8

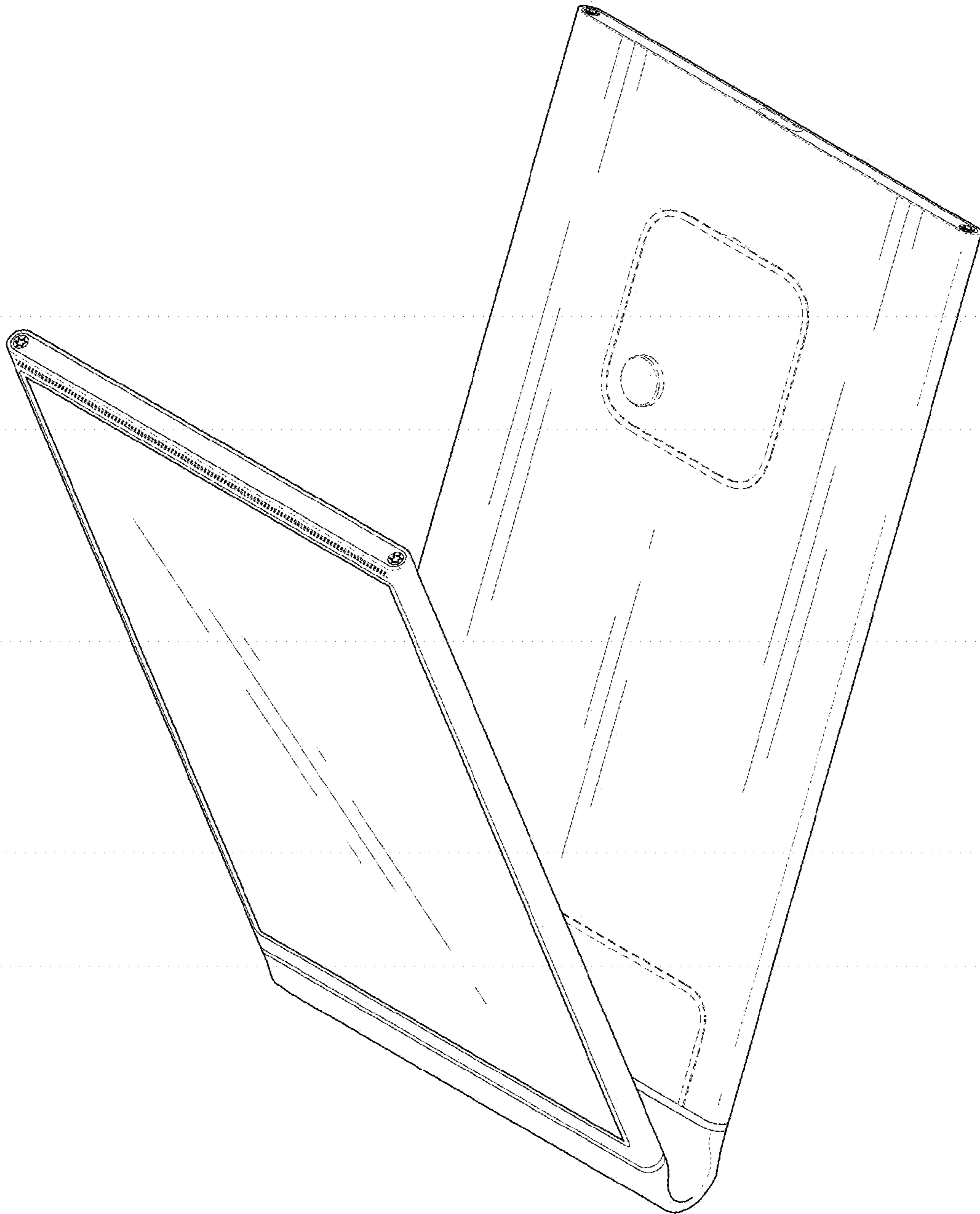

FIG. 9

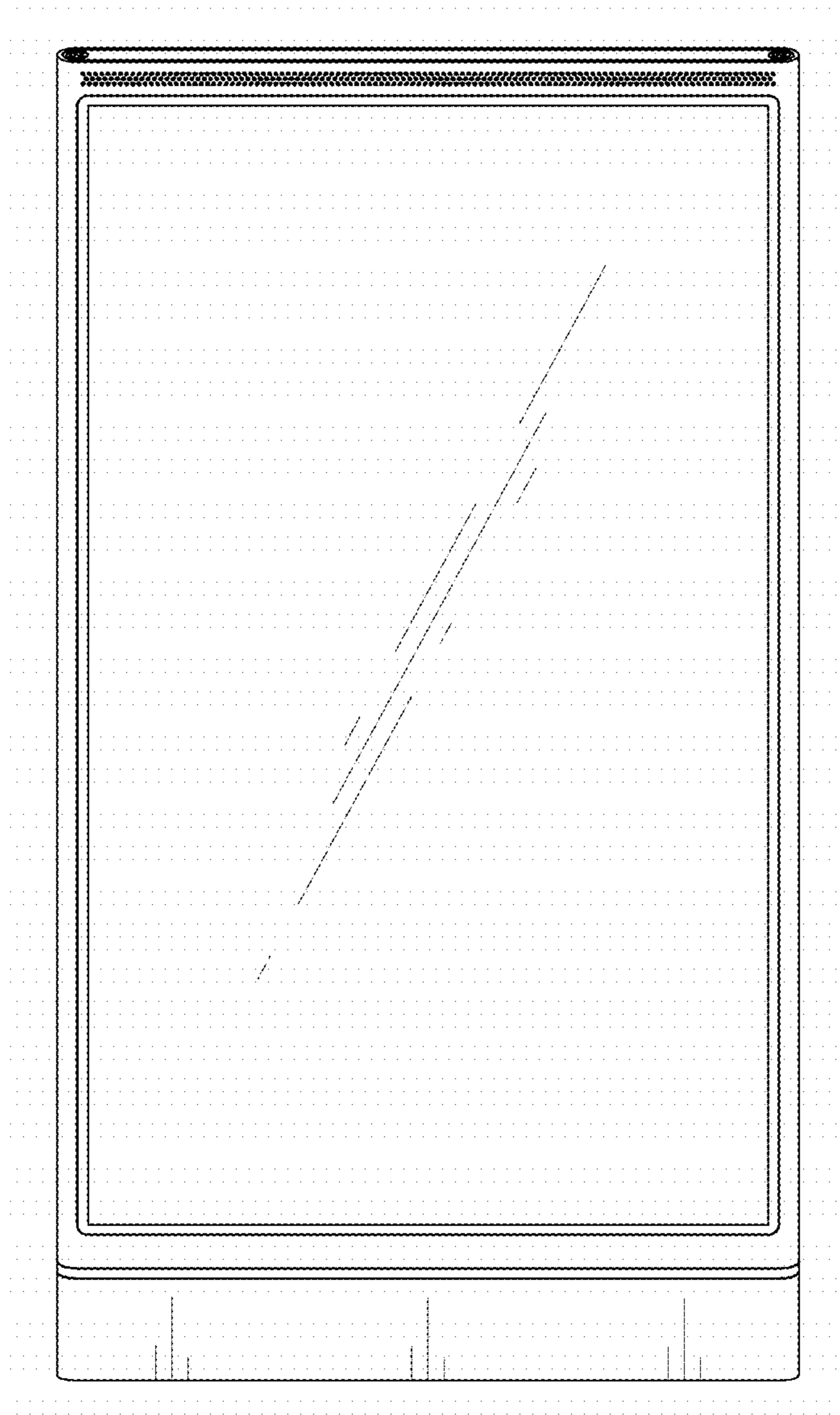

FIG. 10

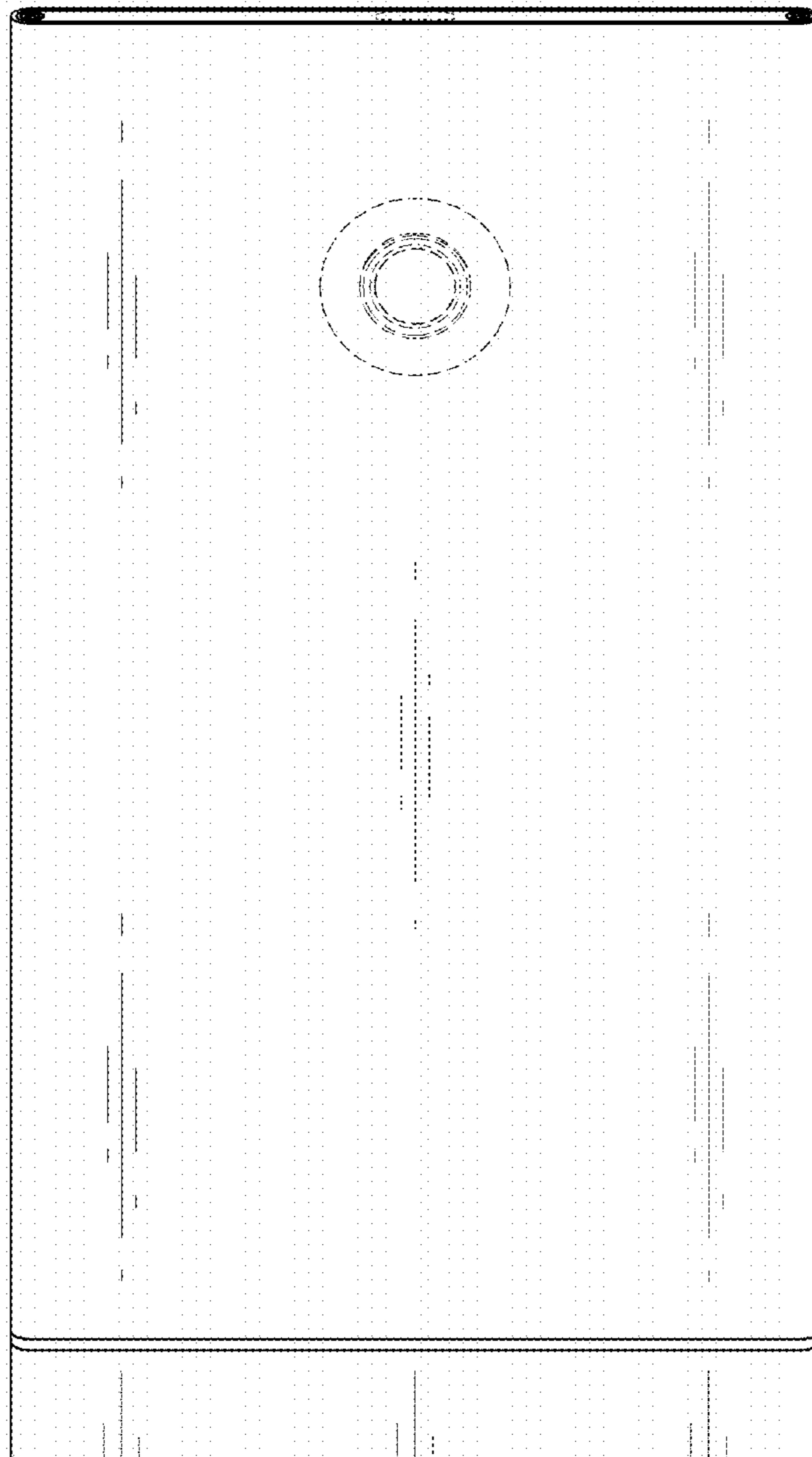

FIG. 11

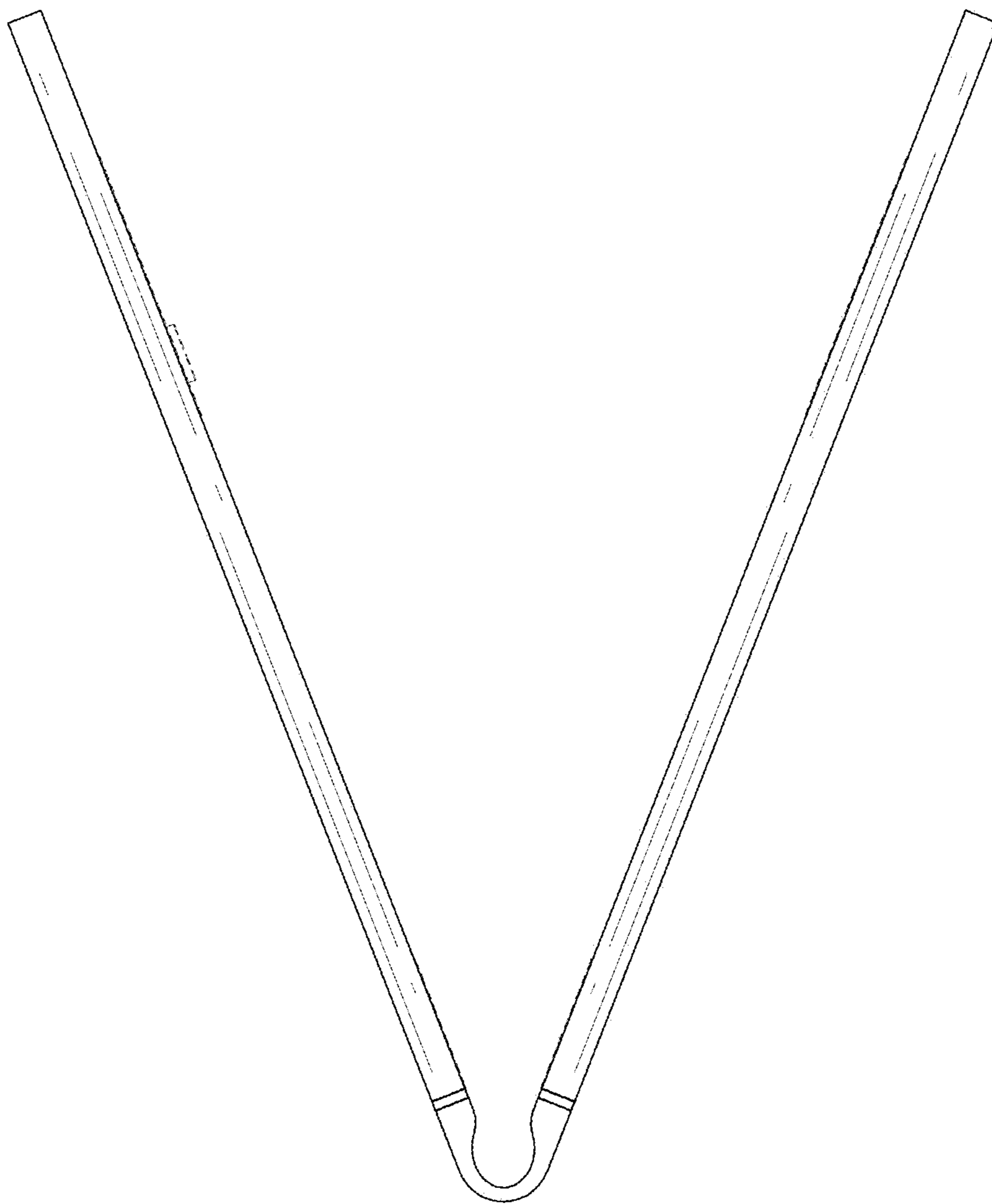

FIG. 12

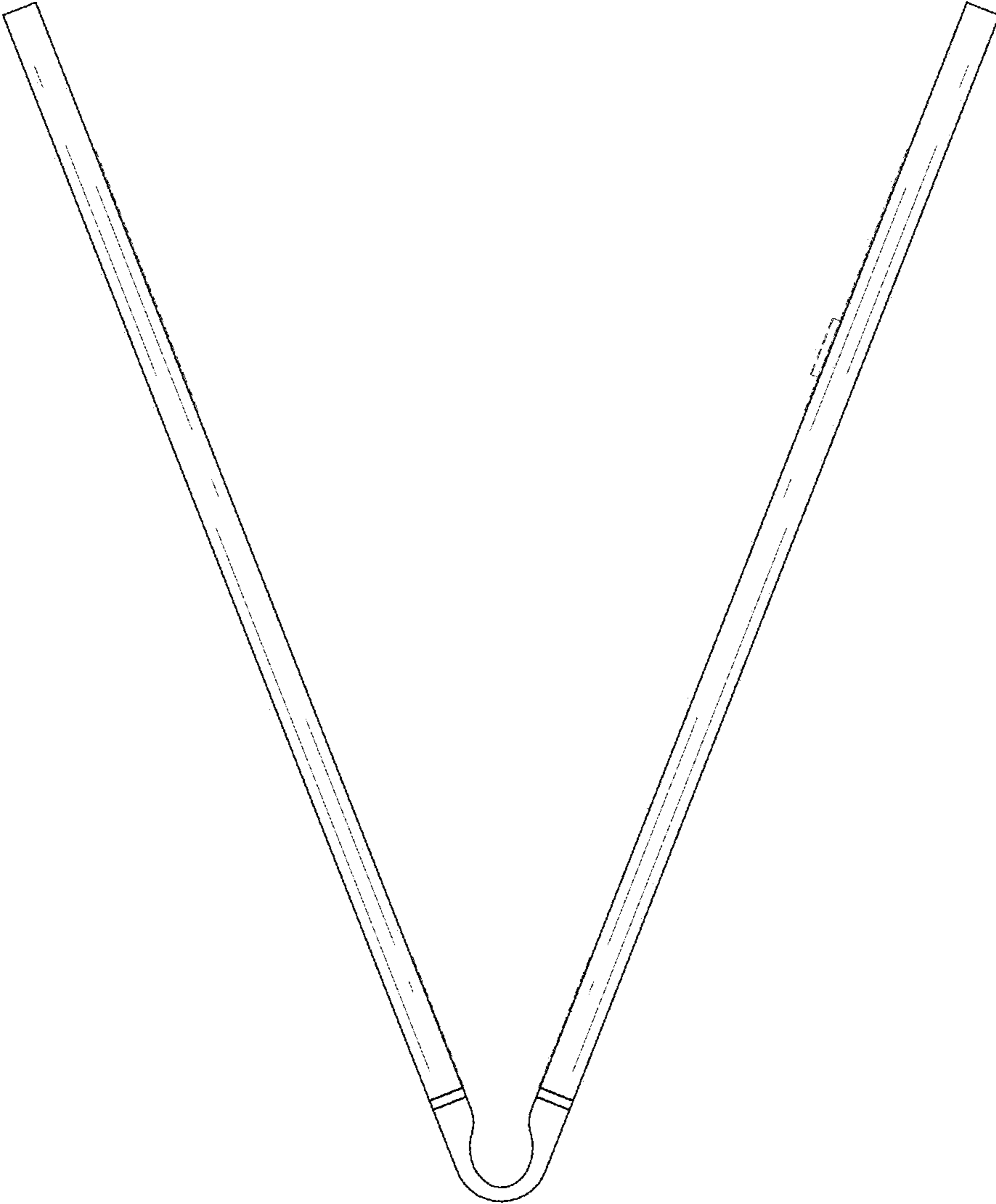

FIG. 13

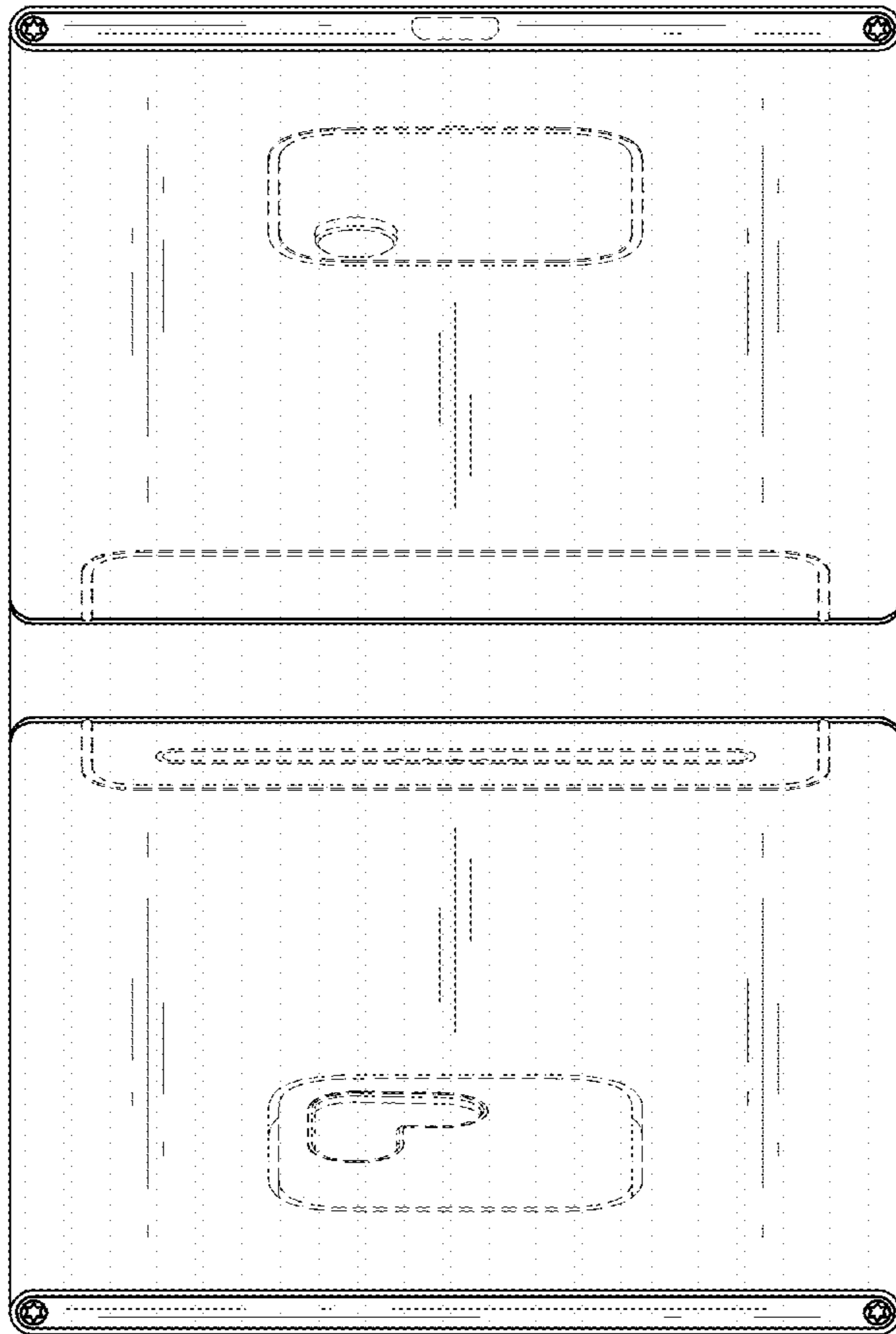

FIG. 14

