



US00D772829S

(12) **United States Design Patent**  
**Han et al.**

(10) **Patent No.:** **US D772,829 S**

(45) **Date of Patent:** **\*\* Nov. 29, 2016**

(54) **TV RECEIVER**

(56) **References Cited**

(71) Applicant: **LG ELECTRONICS INC.**, Seoul (KR)

U.S. PATENT DOCUMENTS

(72) Inventors: **Youngsoo Han**, Seoul (KR); **Jongho Kim**, Seoul (KR); **Sunha Park**, Seoul (KR); **Youngkyoung Kim**, Seoul (KR); **Nari Lee**, Seoul (KR)

D529,005 S *	9/2006	Hong	.....	D14/126
D535,630 S *	1/2007	Yokota	.....	D14/126
D539,245 S *	3/2007	Bischoff	.....	D14/126
D540,760 S *	4/2007	Macey	.....	D14/126
D597,976 S *	8/2009	Gredler	.....	D14/126
D599,791 S *	9/2009	Kuang	.....	D14/314
D680,980 S *	4/2013	Park	.....	D14/126
D715,756 S *	10/2014	Lim	.....	D14/126
D722,300 S *	2/2015	Won	.....	D14/126
D743,922 S *	11/2015	Li	.....	D14/126
D744,439 S *	12/2015	Shin	.....	D14/126
D755,785 S *	5/2016	Sirotych	.....	D14/341
D759,619 S *	6/2016	Seo	.....	D14/126

(73) Assignee: **LG ELECTRONICS INC.**, Seoul (KR)

(\*\*) Term: **15 Years**

\* cited by examiner

(21) Appl. No.: **29/550,729**

*Primary Examiner* — Raphael Barkai

(22) Filed: **Jan. 6, 2016**

(74) *Attorney, Agent, or Firm* — Birch, Stewart, Kolasch & Birch, LLP

(30) **Foreign Application Priority Data**

Jul. 6, 2015 (KR) ..... 30-2015-0034026

(51) **LOC (10) Cl.** ..... **14-03**

(57) **CLAIM**

(52) **U.S. Cl.**  
USPC ..... **D14/126**

The ornamental design for a TV receiver, as shown and described.

(58) **Field of Classification Search**

**DESCRIPTION**

USPC ..... D14/125-134, 239, 371, 136, 374-377, D14/440, 450, 448, 336, 342, 159; 312/7.2; 348/836, 838, 180, 184, 325, 739; 248/917-924, 465; 345/104, 133, 156, 345/168, 87, 173; D21/329, 515, 577, 622, D21/333, 433, 448, 452, 450, 331, 505; D10/15, 26; 446/484, 175, 356; D6/477, 479, 300; D20/10, 19, 39; D16/203, 241; 160/24

CPC .. G06F 1/1601; G06F 1/1643; G06F 1/1652; G06F 1/1647; G06F 3/0412; H05K 5/0004; H05K 5/0017; H05K 5/02; H05K 5/0217; H04N 13/0459

FIG. 1 is a front, right side, perspective view of a TV receiver showing our new design;  
 FIG. 2 is a front view thereof;  
 FIG. 3 is a rear view thereof;  
 FIG. 4 is a left side view thereof;  
 FIG. 5 is a right side view thereof;  
 FIG. 6 is a top view thereof; and,  
 FIG. 7 is a bottom view thereof.

The broken lines indicate unclaimed portion of the article that form no part of the claimed design.

See application file for complete search history.

**1 Claim, 4 Drawing Sheets**

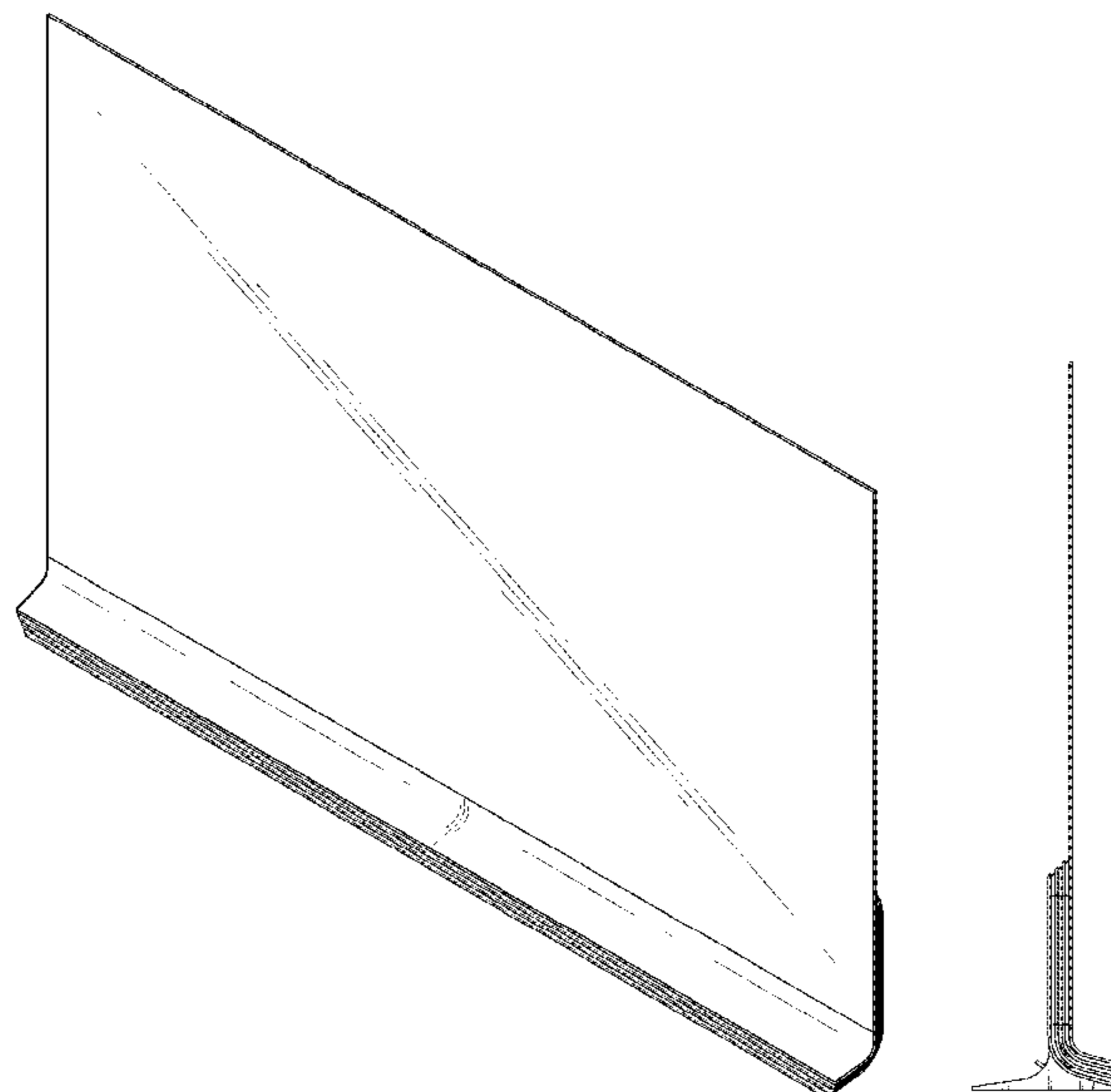

FIG. 1

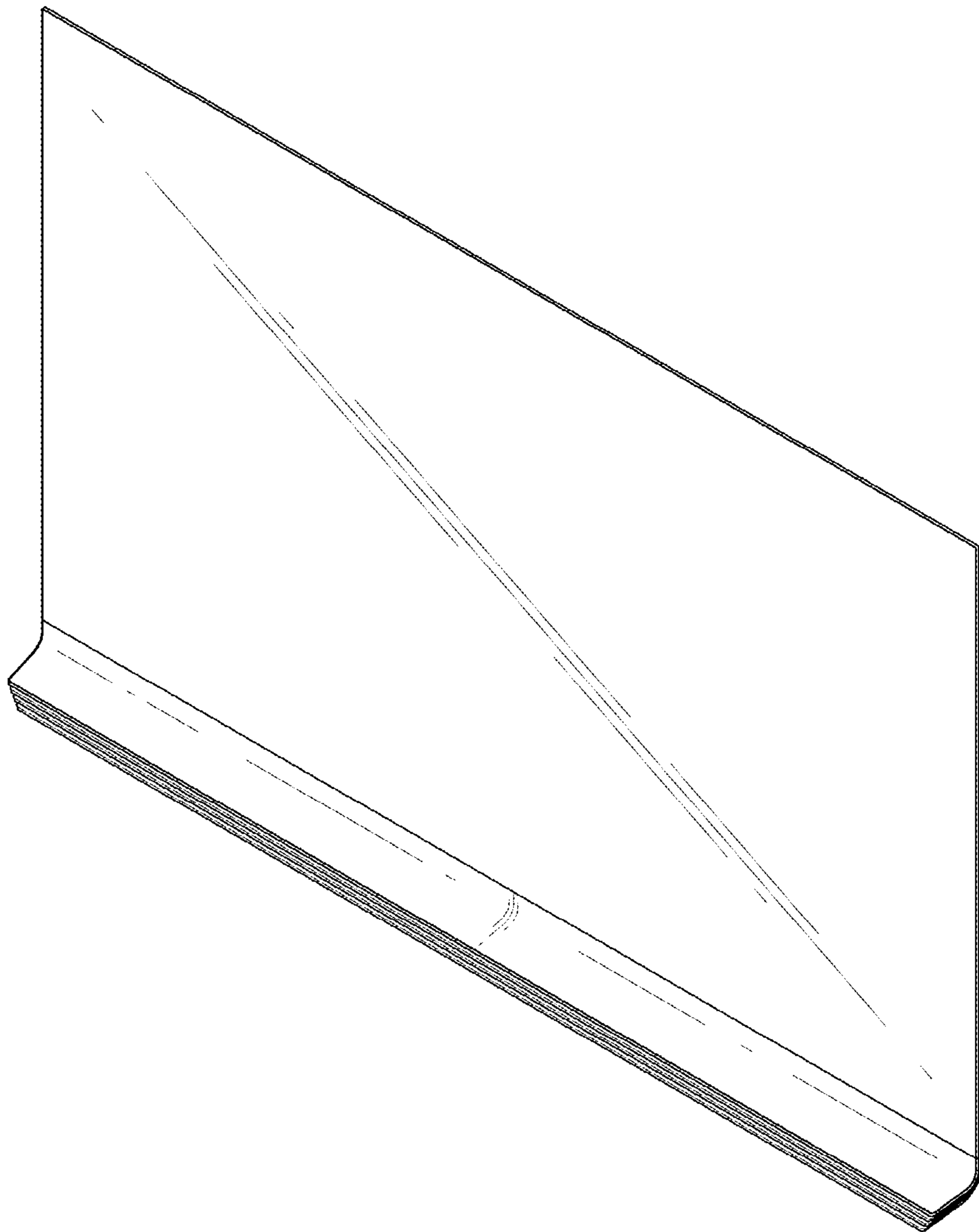

FIG. 2

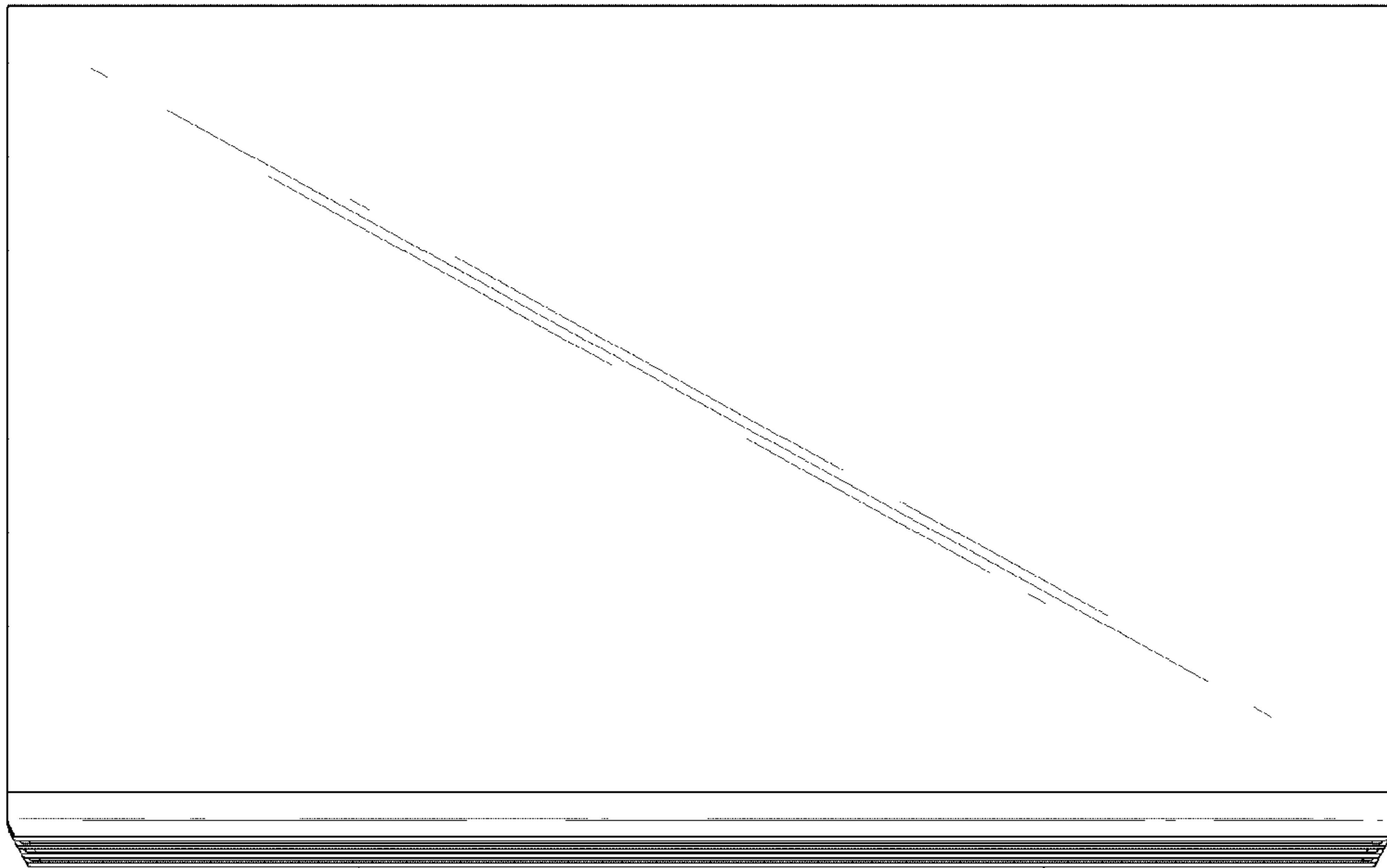

FIG. 3

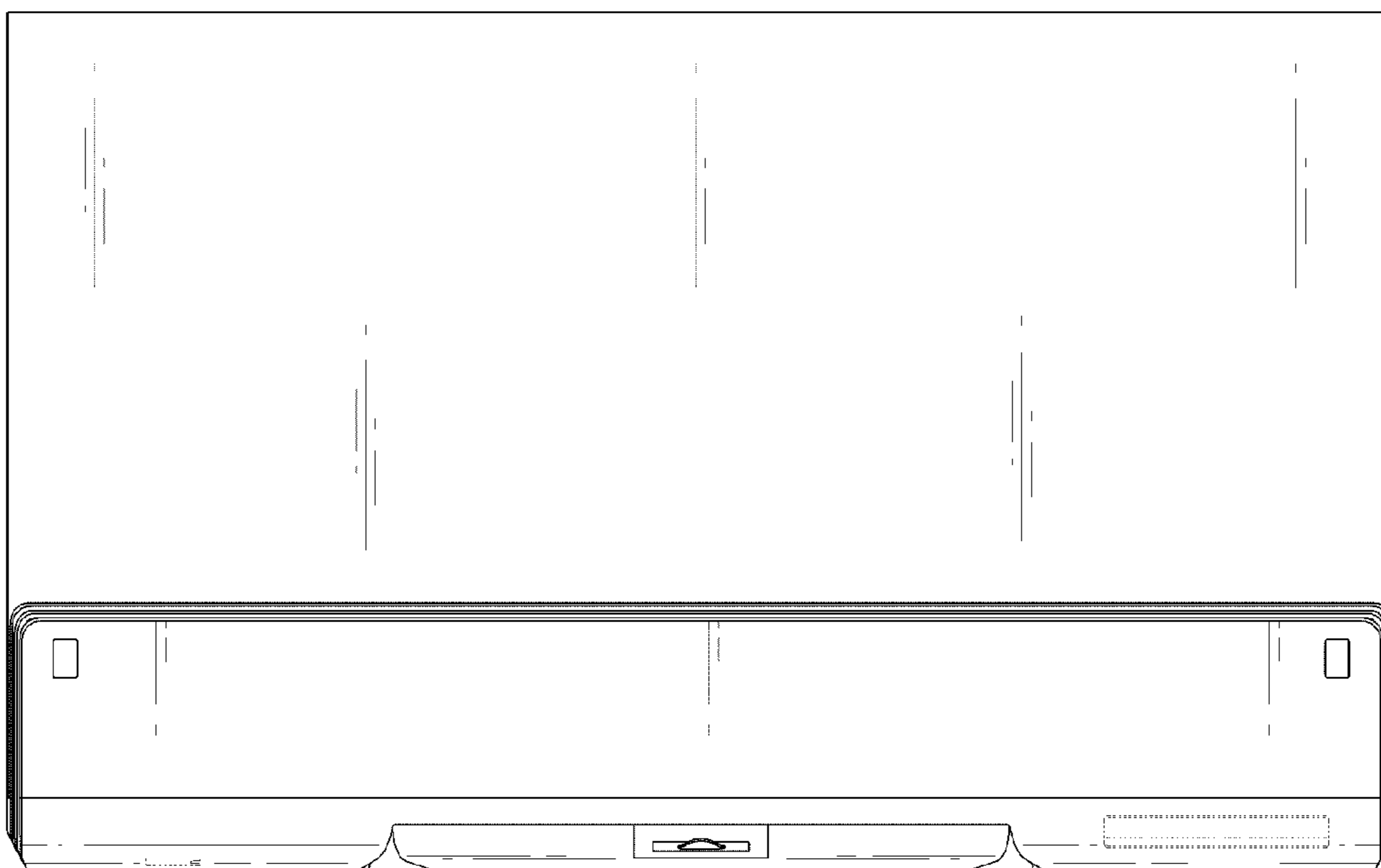

FIG. 4

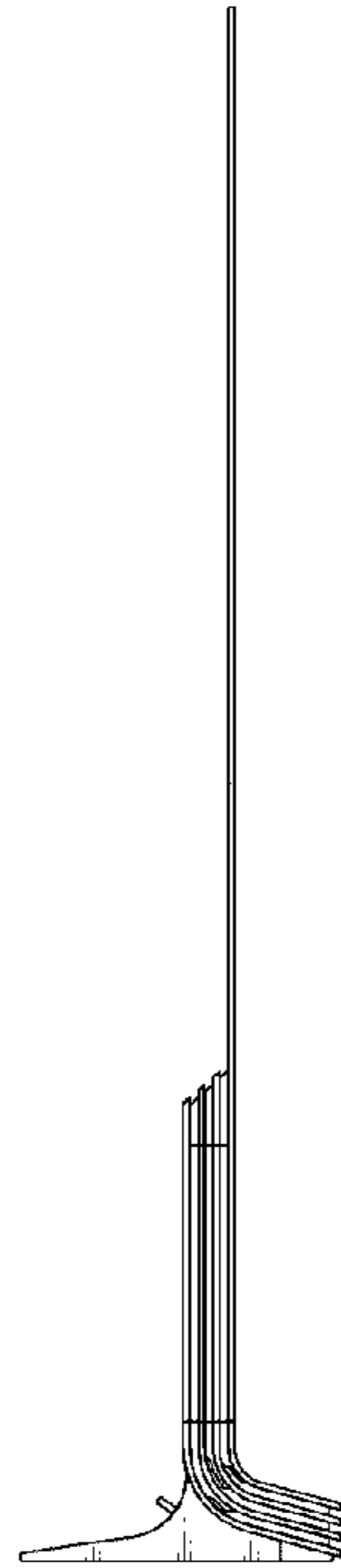

FIG. 5

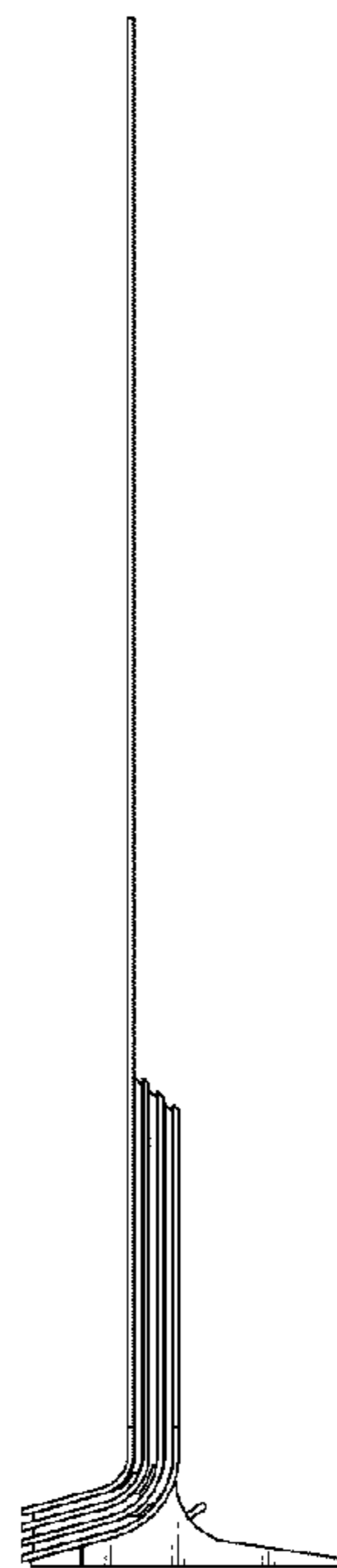

FIG. 6

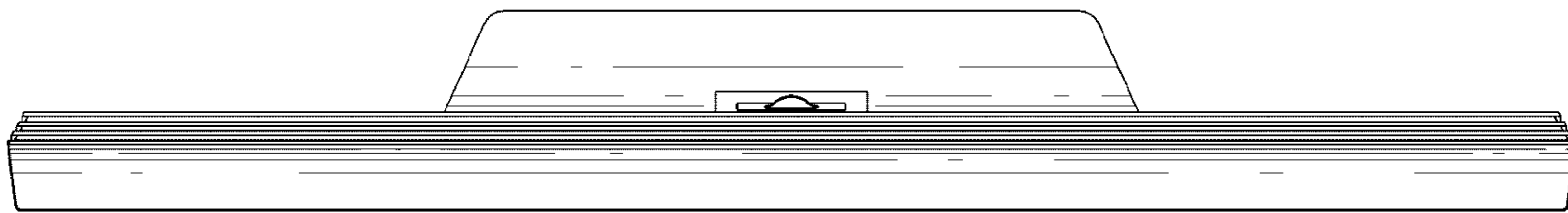

FIG. 7

