



US00D772726S

(12) **United States Design Patent**
Ramsey

(10) **Patent No.:** **US D772,726 S**

(45) **Date of Patent:** **** Nov. 29, 2016**

(54) **BEVERAGE CAN**

(71) Applicant: **CROWN Packaging Technology, Inc.**,
Alsip, IL (US)

(72) Inventor: **Christopher Paul Ramsey**, Wantage
(GB)

(73) Assignee: **Crown Packaging Technology, Inc.**,
Alsip, IL (US)

(**) Term: **15 Years**

(21) Appl. No.: **29/541,832**

(22) Filed: **Oct. 8, 2015**

(51) **LOC (10) Cl.** **09-01**

(52) **U.S. Cl.**
USPC **D9/772**

(58) **Field of Classification Search**

USPC D9/500, 502, 516, 530, 537, 539, 542,
D9/549, 763-783; 215/381-385; 220/660,
220/669, 675

CPC B65D 1/00; B65D 1/02; B65D 1/12;
B65D 1/14; B65D 1/40; B65D 1/44;
B65D 1/023; B65D 1/0223; B65D
1/165; B65D 1/238; B65D 1/246; B65D
1/253; B65D 7/04; B65D 21/0209;
B65D 21/0233; B65D 25/00; B65D
25/28; B65D 41/0457; B65D 41/17;
B65D 53/06; B65D 75/56; B65D
79/005; B65D 2501/0036; B65D
2543/00064; B65D 2543/00074; B65D
2543/00083; B65D 2543/00092; B65D
2543/00101; B65D 2543/00111

See application file for complete search history.

(56) **References Cited**

U.S. PATENT DOCUMENTS

D570,228 S * 6/2008 van Dam D9/772
D603,722 S * 11/2009 Reimer D9/766
D605,060 S * 12/2009 Reimer D9/766
D632,588 S * 2/2011 George D9/772

D641,644 S * 7/2011 George D9/772
D693,120 S * 11/2013 Roth D3/271.1
D693,698 S * 11/2013 Miller, Jr. D9/772
D701,464 S * 3/2014 Ogata D9/772
D713,268 S * 9/2014 Jones D9/772
D732,402 S * 6/2015 Jones D9/772

* cited by examiner

Primary Examiner — Keli L Hill

(74) *Attorney, Agent, or Firm* — Baker & Hostetler LLP

(57) **CLAIM**

I claim the ornamental design for a beverage can, as shown and described.

DESCRIPTION

FIG. 1 is a top perspective view of a first embodiment of a beverage can, showing my new design in an unopened configuration;

FIG. 2 is a bottom perspective view thereof;

FIG. 3 is a front view thereof, the rear, left and right side views being identical thereto;

FIG. 4 is a top view thereof;

FIG. 5 is a bottom view thereof;

FIG. 6 is an alternate top perspective view thereof, shown in an opened configuration;

FIG. 7 is a top view of FIG. 6;

FIG. 8 is a top perspective view of a second embodiment of a beverage can, showing my new design in an unopened configuration;

FIG. 9 is a bottom perspective view thereof;

FIG. 10 is a front view thereof, the rear, left and right side views being identical thereto;

FIG. 11 is a top view thereof;

FIG. 12 is a bottom view thereof;

FIG. 13 is an alternate top perspective view thereof, shown in an opened configuration;

FIG. 14 is a top view of FIG. 13;

FIG. 15 is a top perspective view of a third embodiment of a beverage can, showing my new design in an unopened configuration;

FIG. 16 is a bottom perspective view thereof;

FIG. 17 is a front view thereof, the rear, left and right side views being identical thereto;

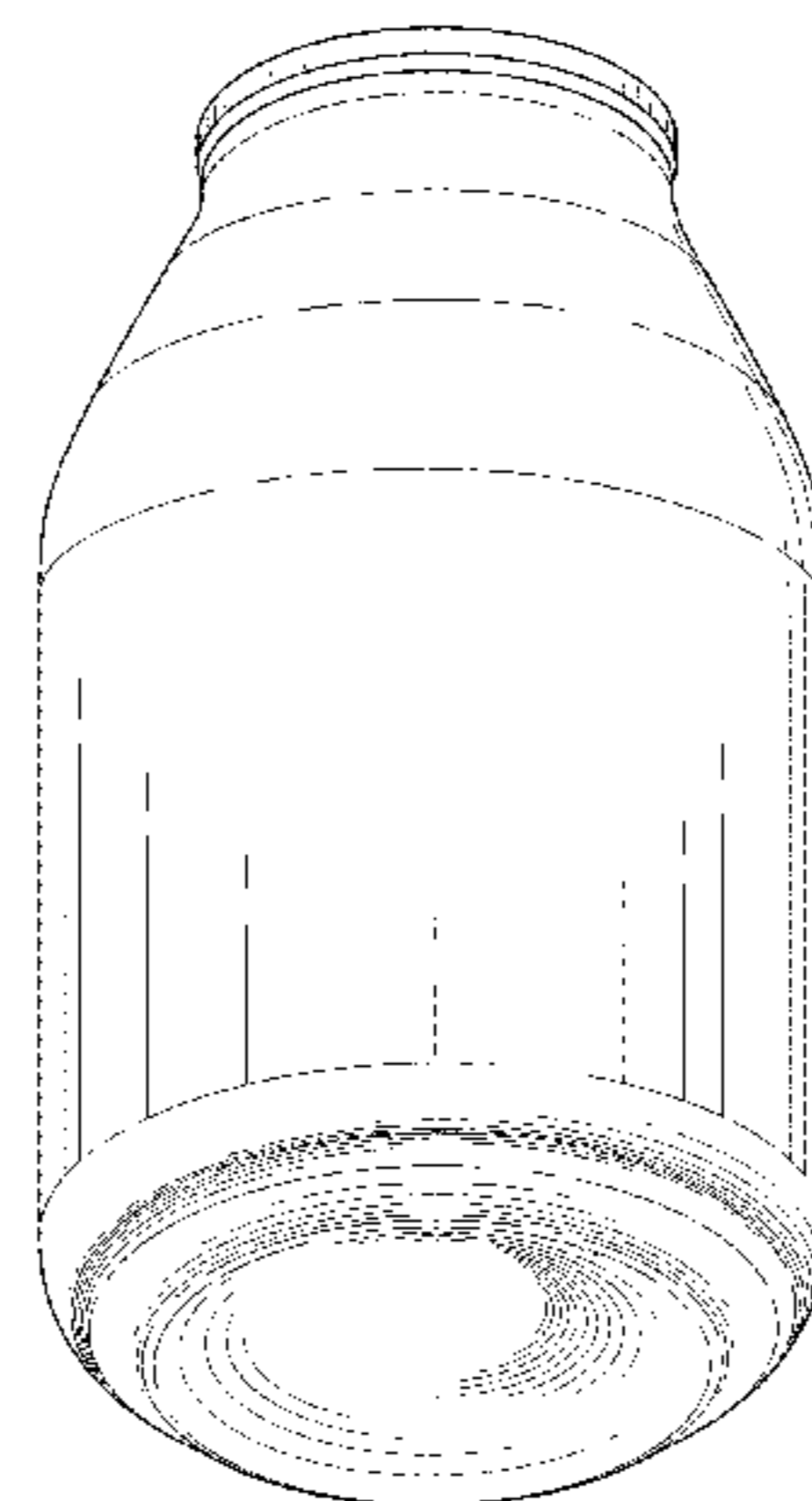
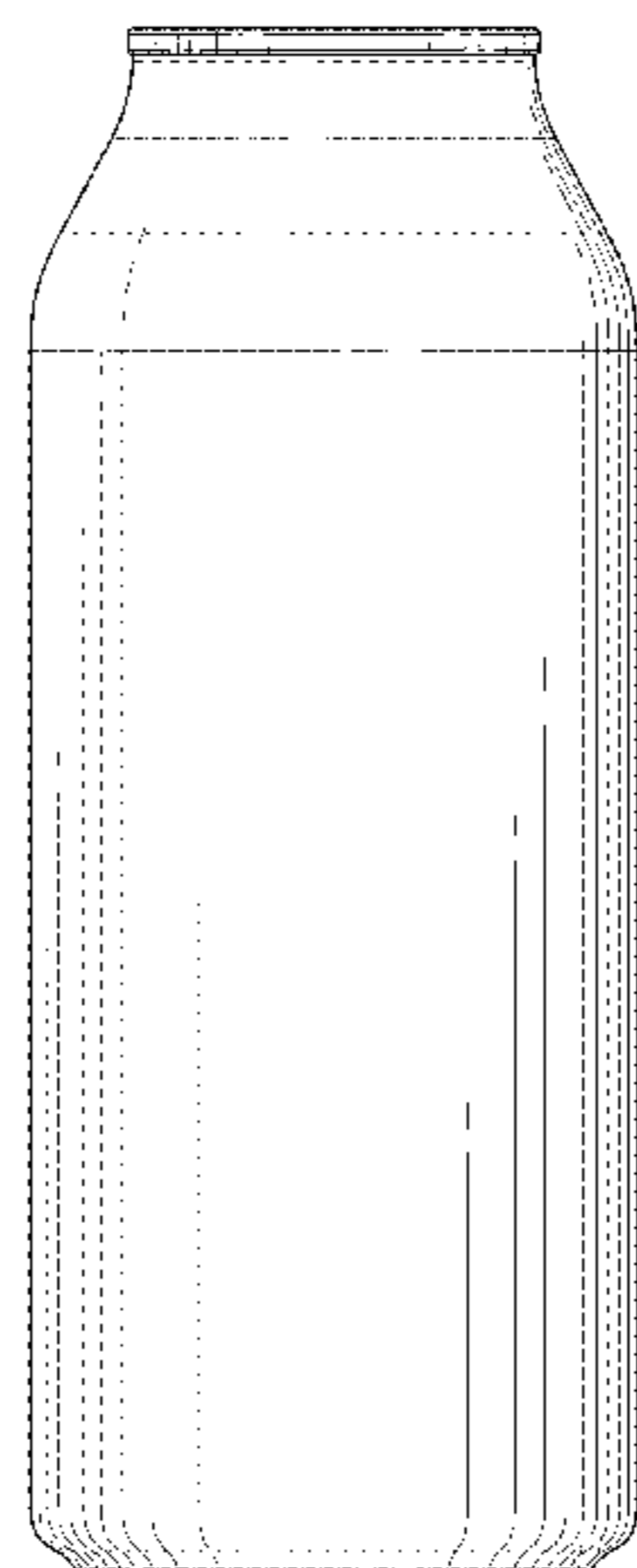

FIG. 18 is a top view thereof;
FIG. 19 is a bottom view thereof;
FIG. 20 is an alternate top perspective view thereof, shown in an opened configuration;
FIG. 21 is a top view of FIG. 20;
FIG. 22 is a top perspective view of a fourth embodiment of a beverage can, showing my new design in an unopened configuration;
FIG. 23 is a bottom perspective view thereof;
FIG. 24 is a front view thereof, the rear, left and right side views being identical thereto;
FIG. 25 is a top view thereof;
FIG. 26 is a bottom view thereof;
FIG. 27 is an alternate top perspective view thereof, shown in an opened configuration;

FIG. 28 is a top view of FIG. 27;
FIG. 29 is a top perspective view of a fifth embodiment of a beverage can, showing my new design in an unopened configuration;
FIG. 30 is a bottom perspective view thereof;
FIG. 31 is a front view thereof, the rear, left and right side views being identical thereto;
FIG. 32 is a top view thereof;
FIG. 33 is a bottom view thereof;
FIG. 34 is an alternate top perspective view thereof, shown in an opened configuration; and,
FIG. 35 is a top view of FIG. 34.
The broken lines in the drawings are to illustrate environment only and form no part of the claimed design.

1 Claim, 30 Drawing Sheets

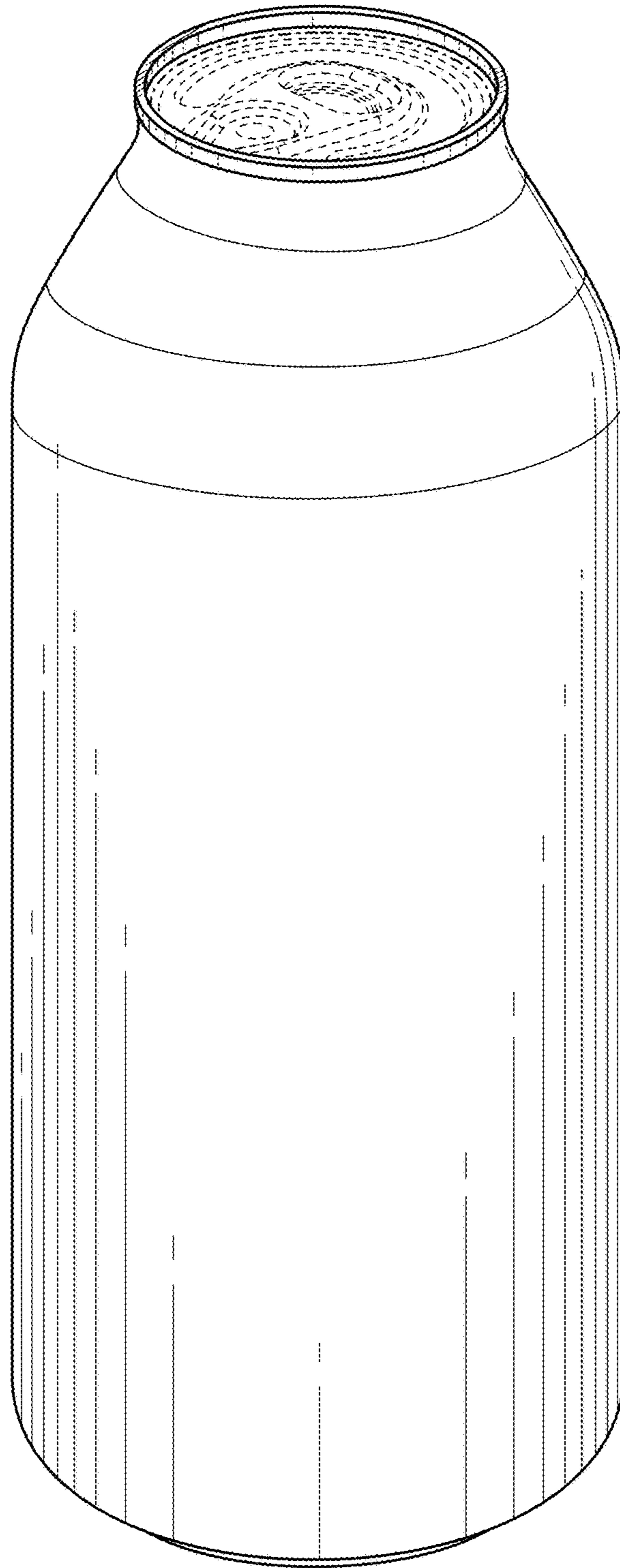

FIG. 1

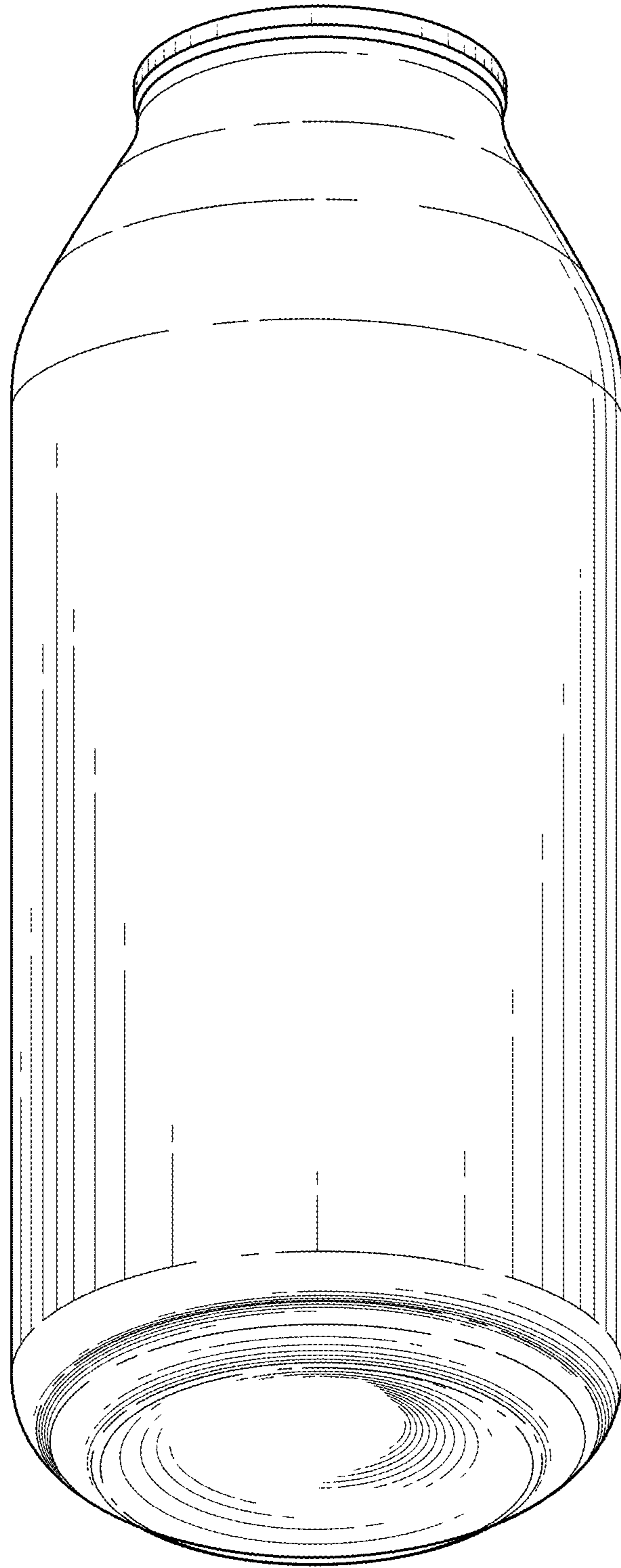

FIG. 2

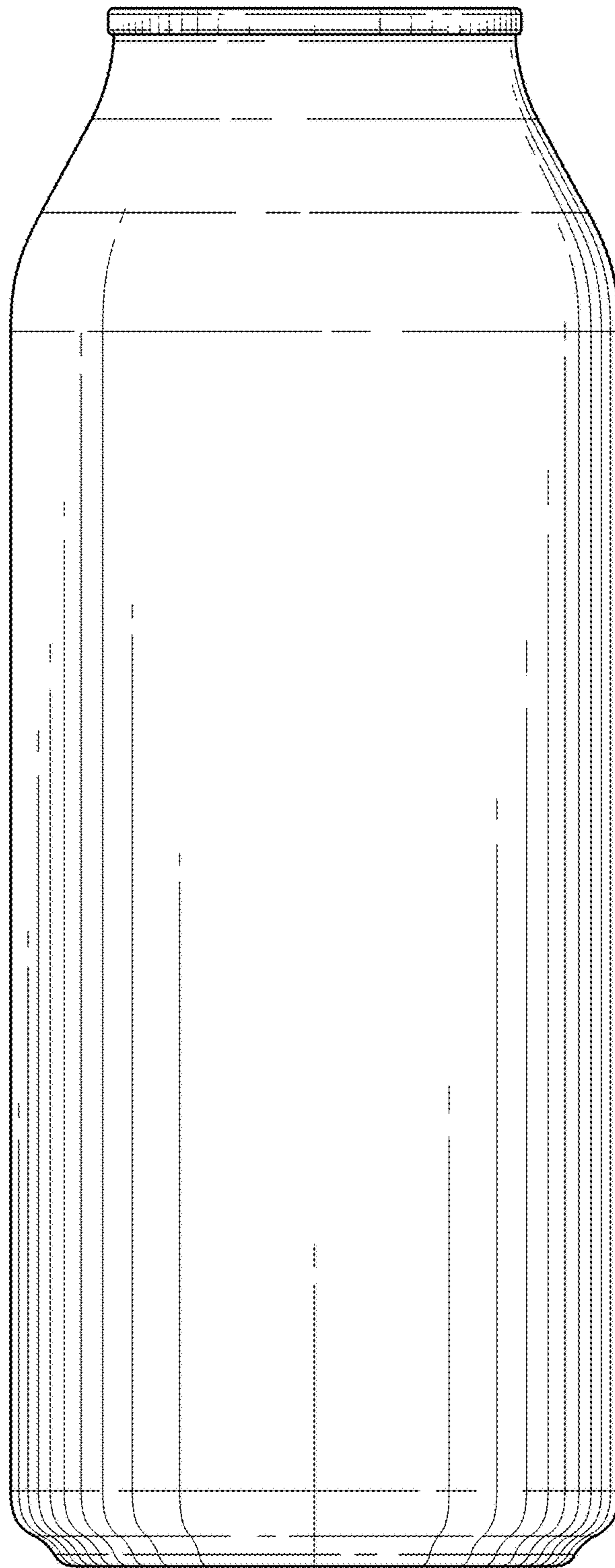

FIG. 3

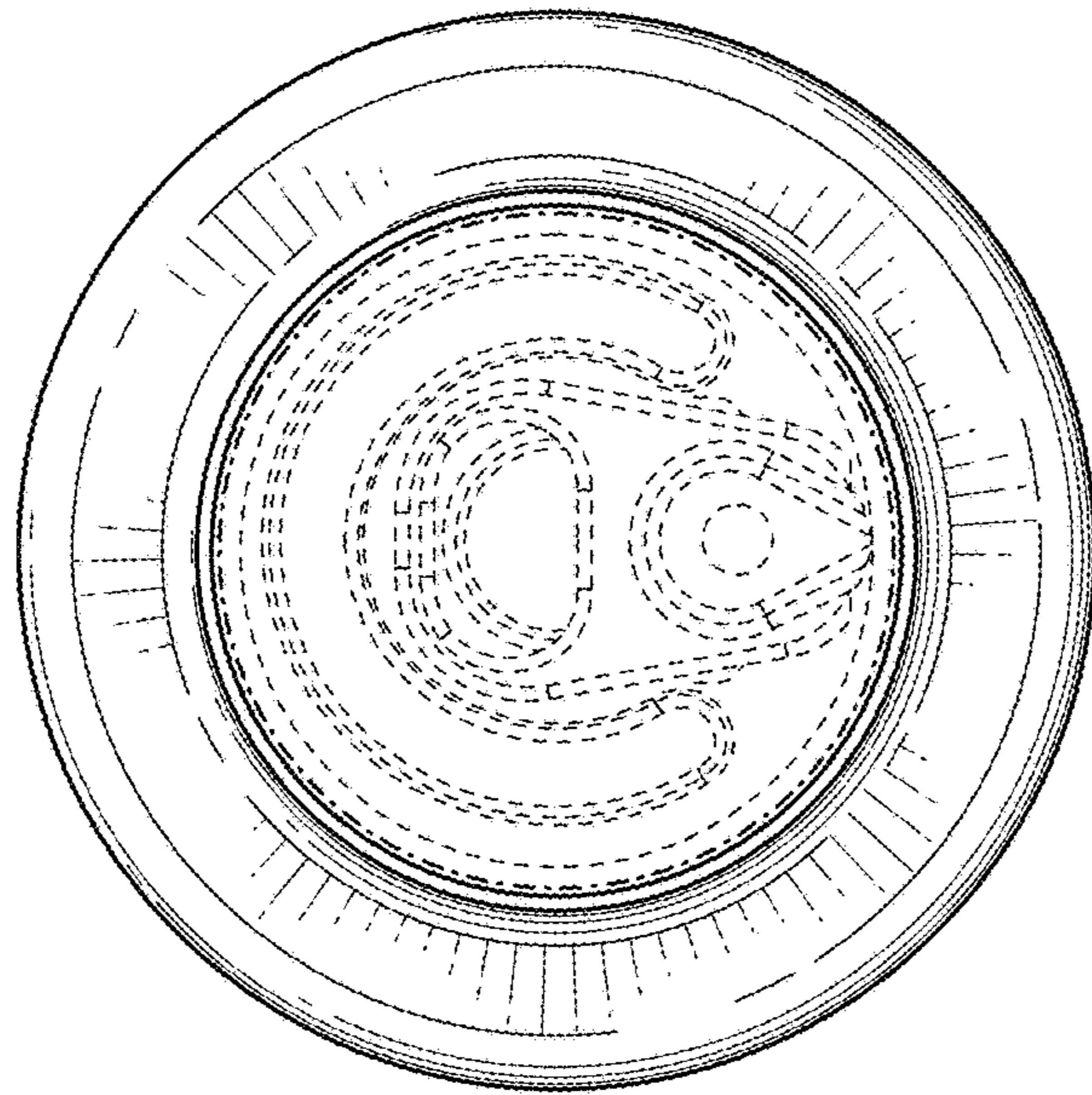

FIG. 4

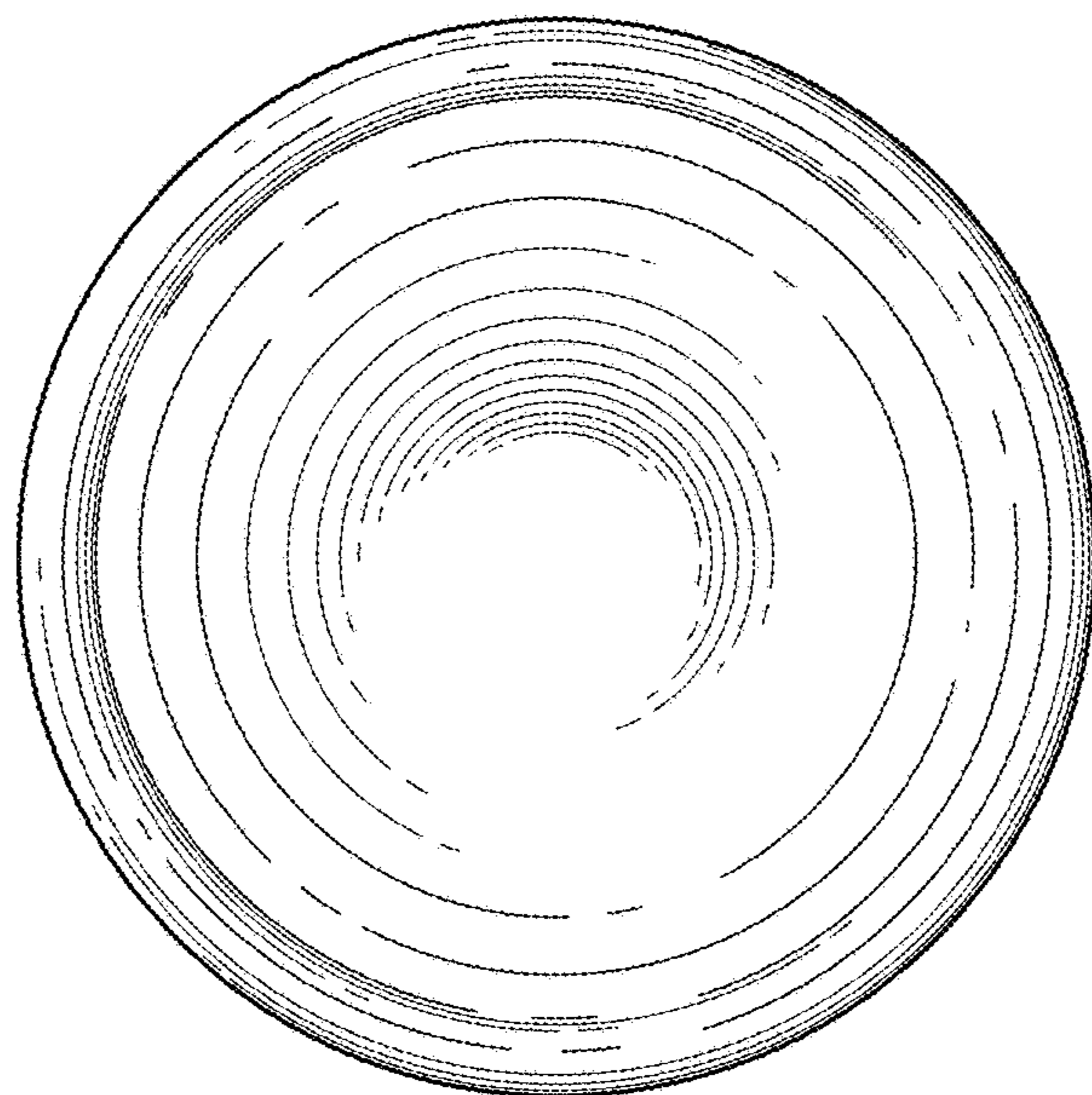

FIG. 5

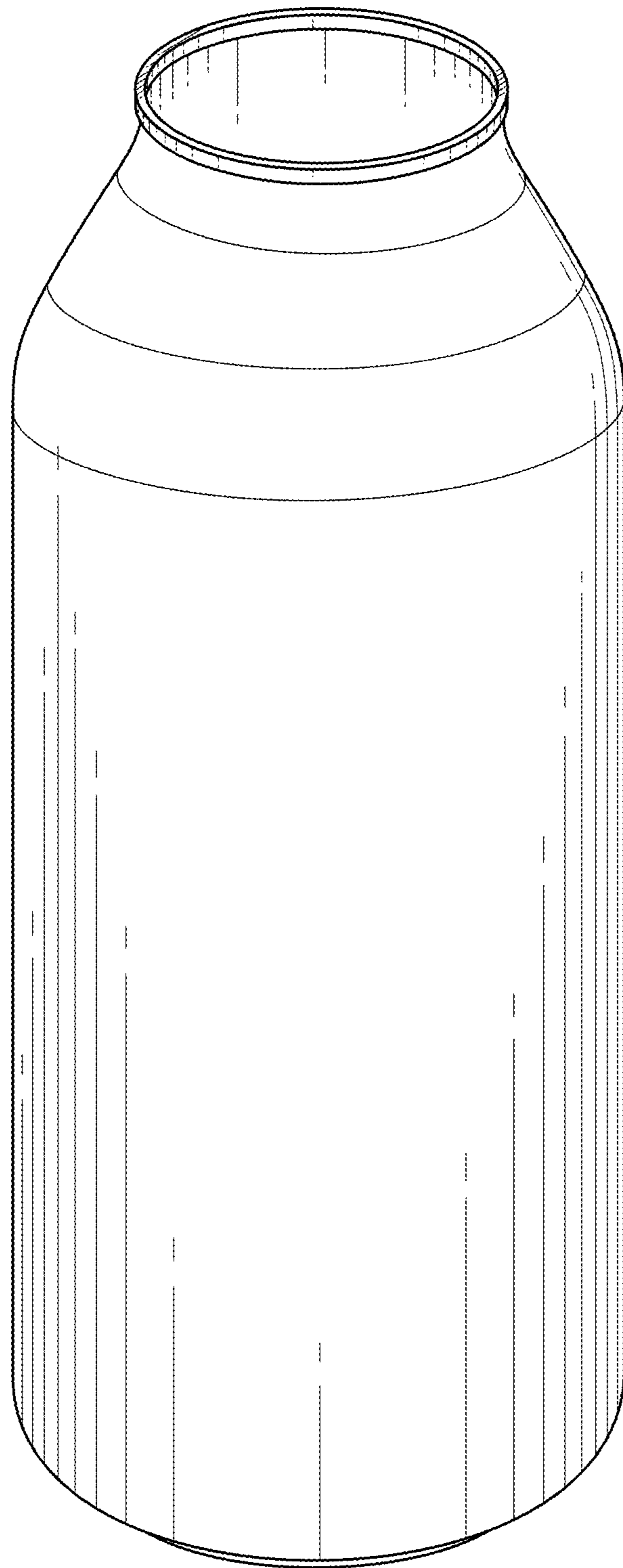

FIG. 6

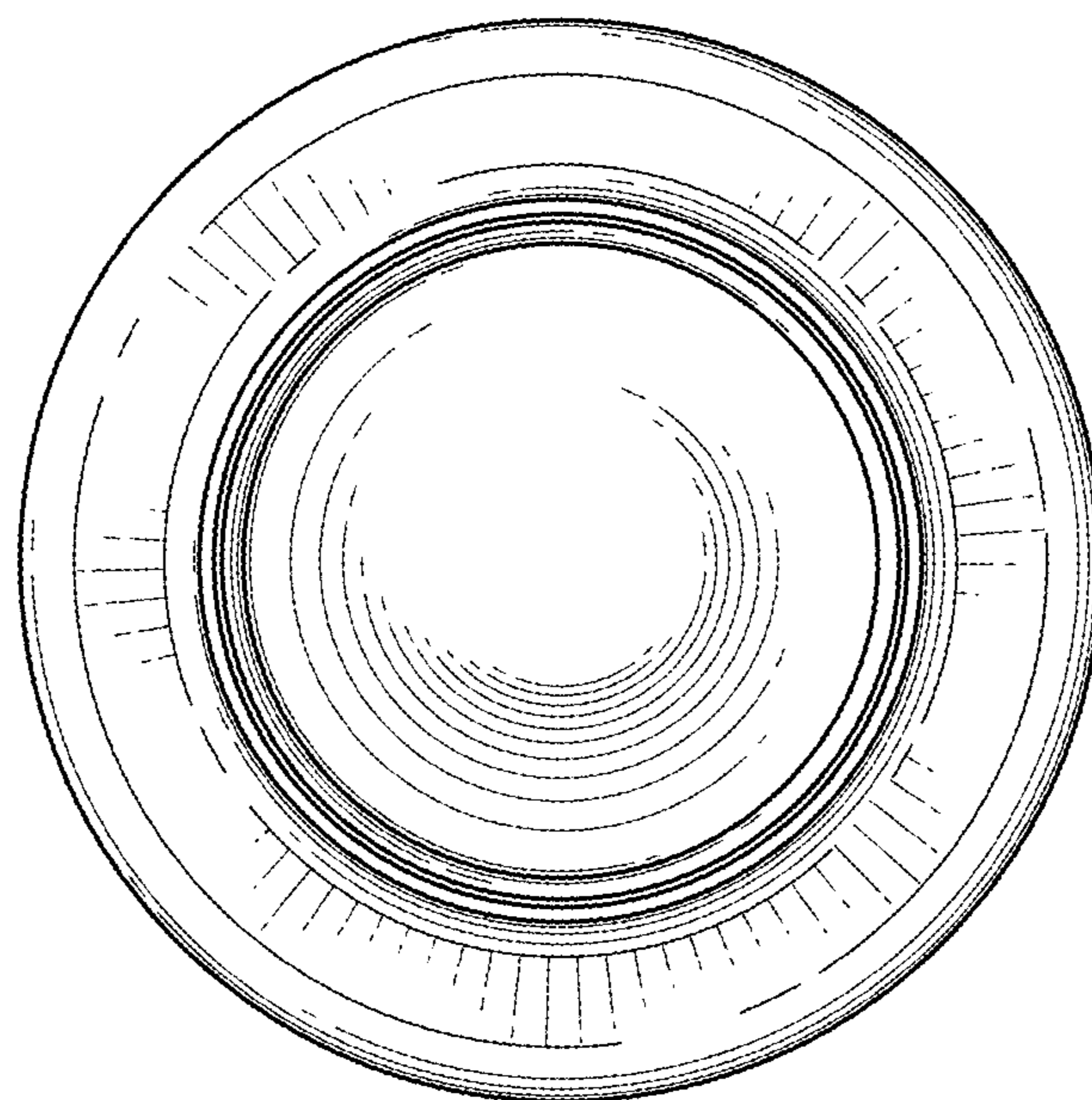

FIG. 7

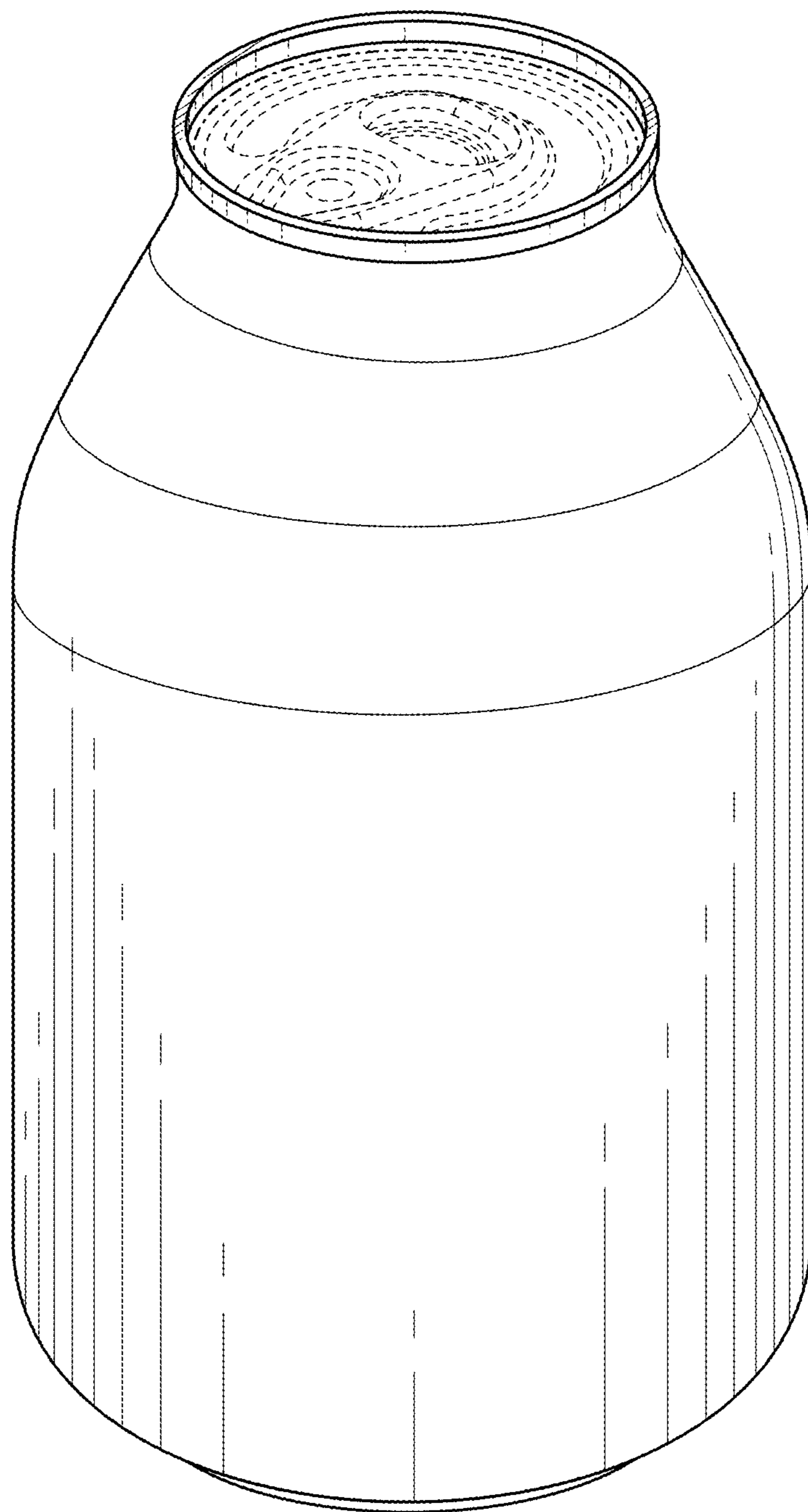

FIG. 8

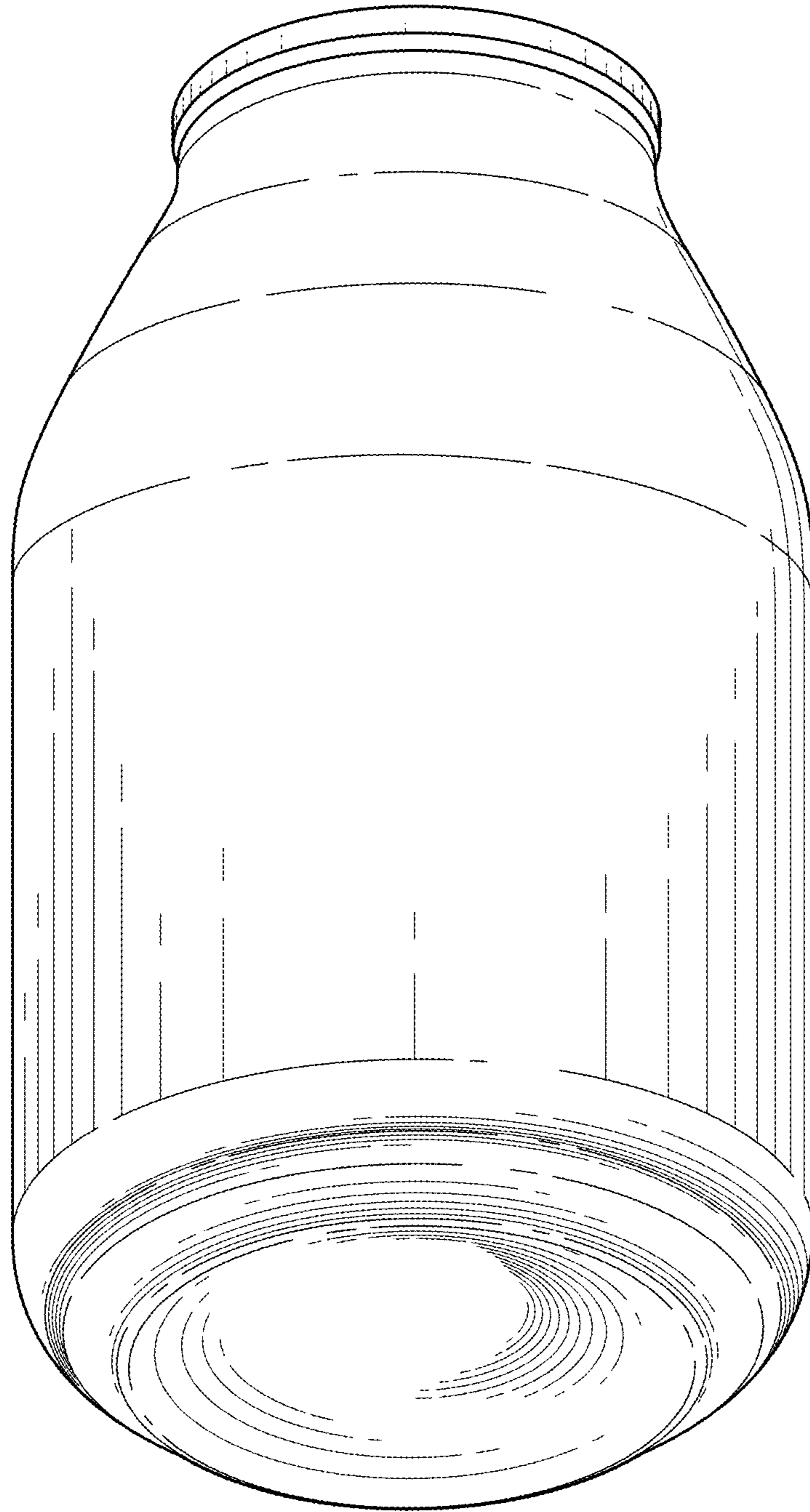

FIG. 9

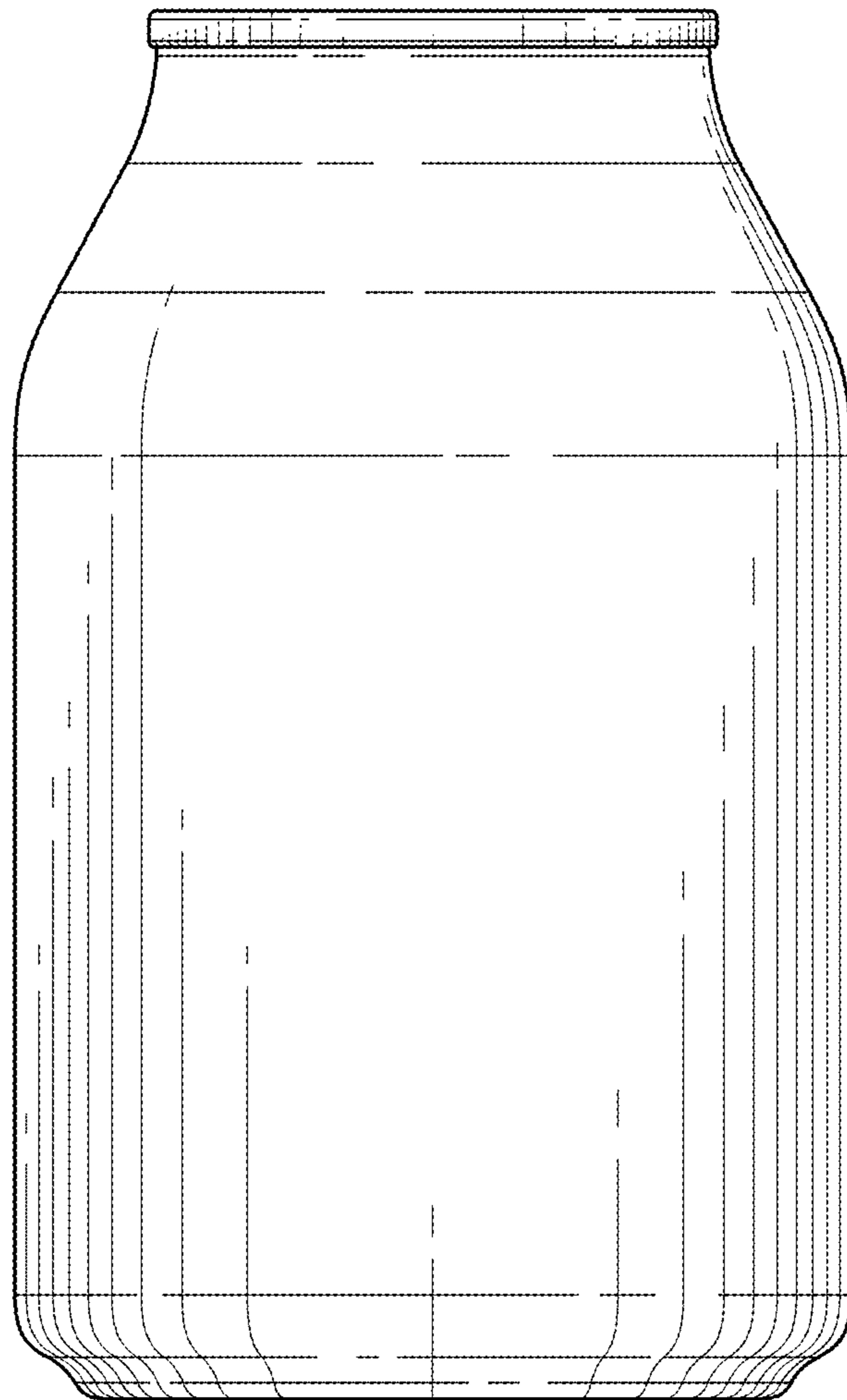

FIG. 10

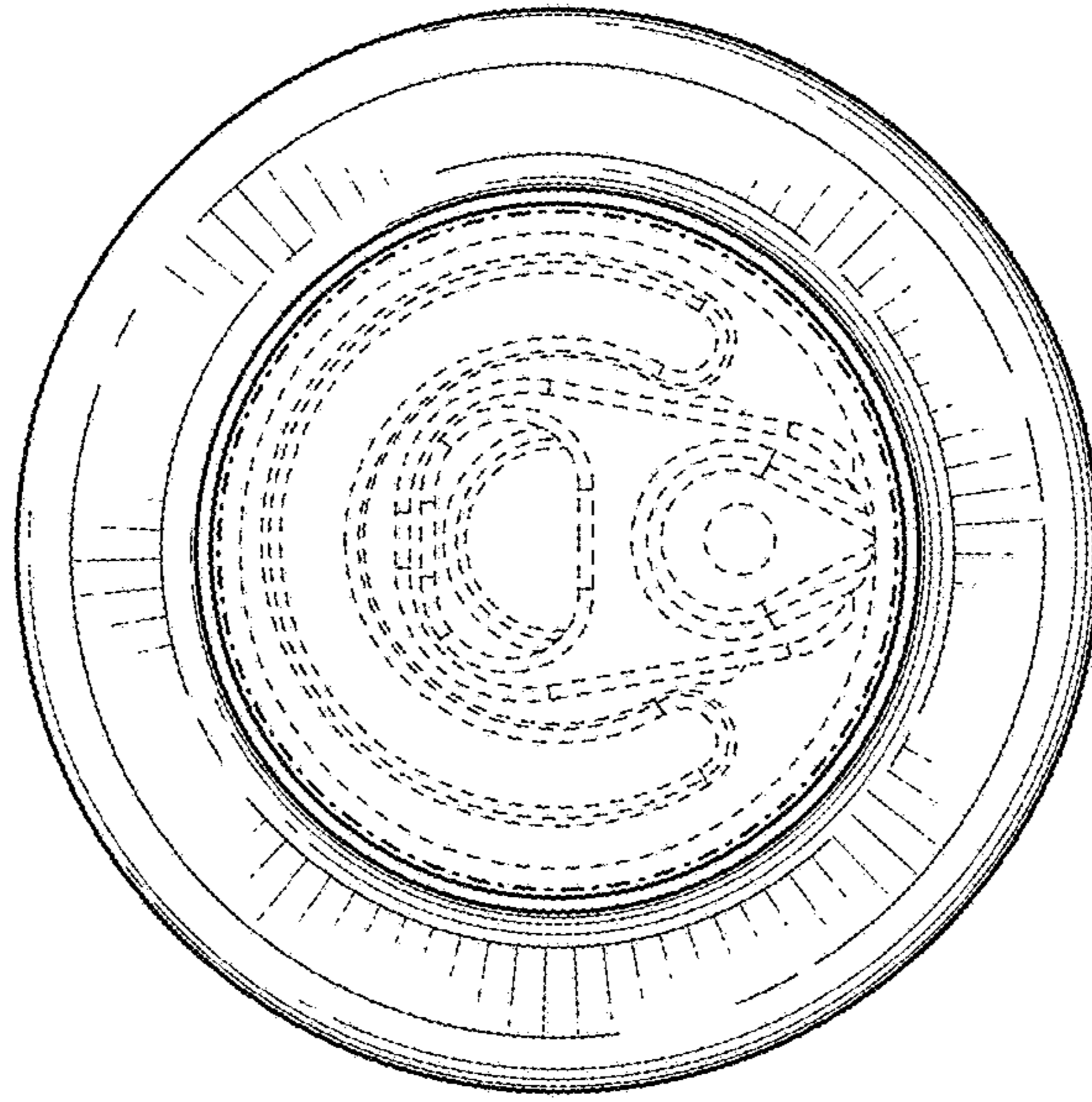

FIG. 11

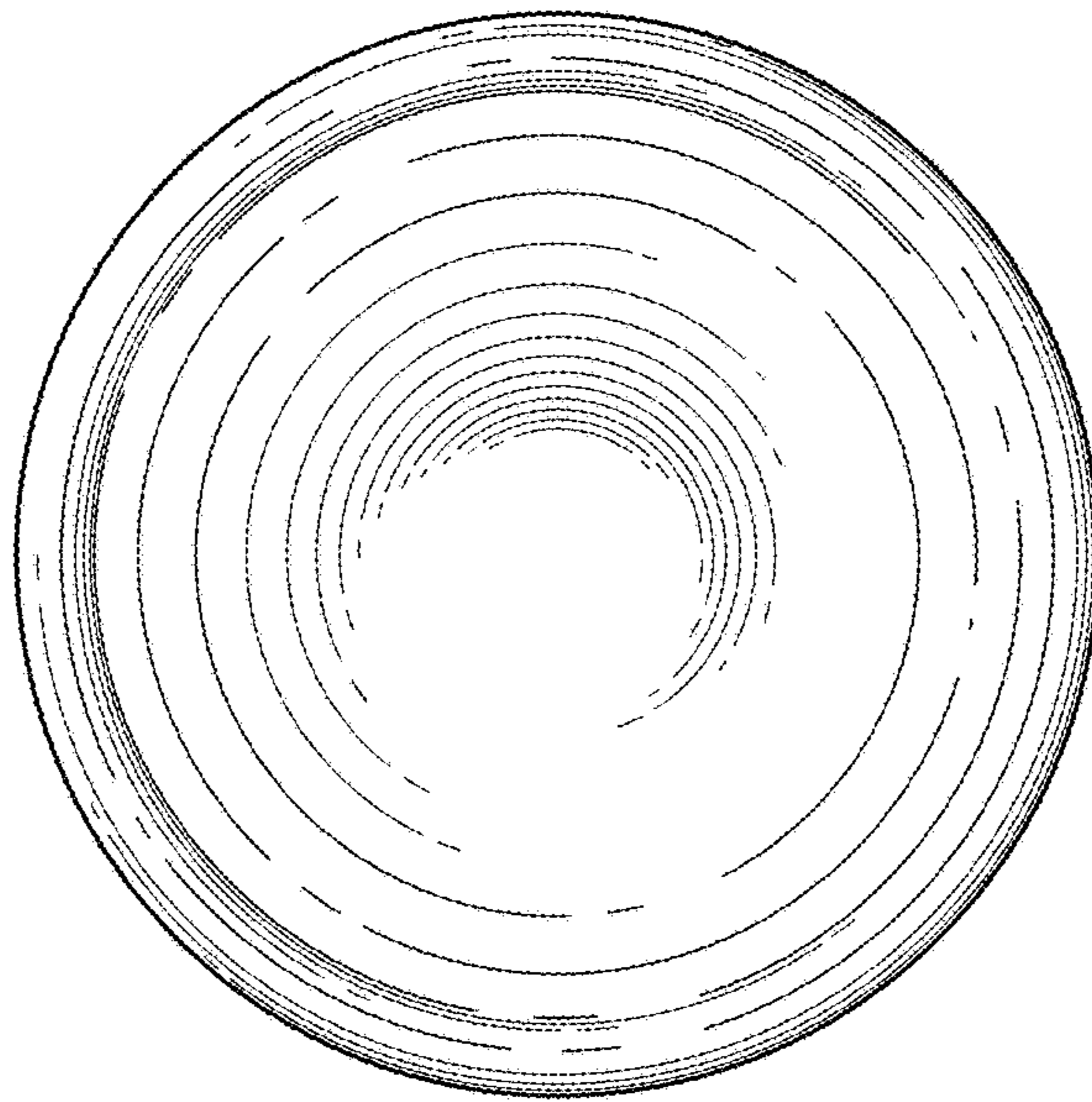

FIG. 12

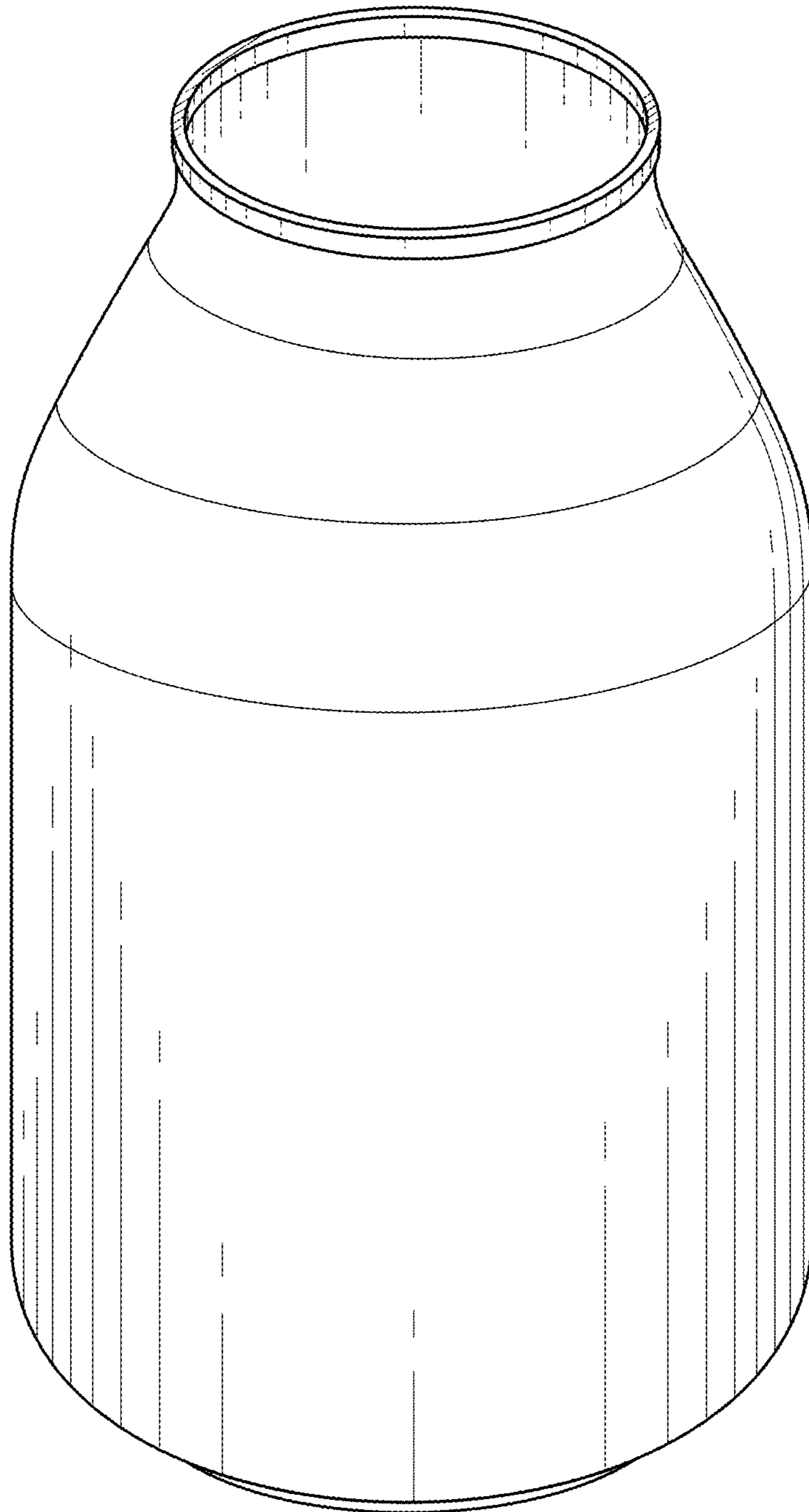

FIG. 13

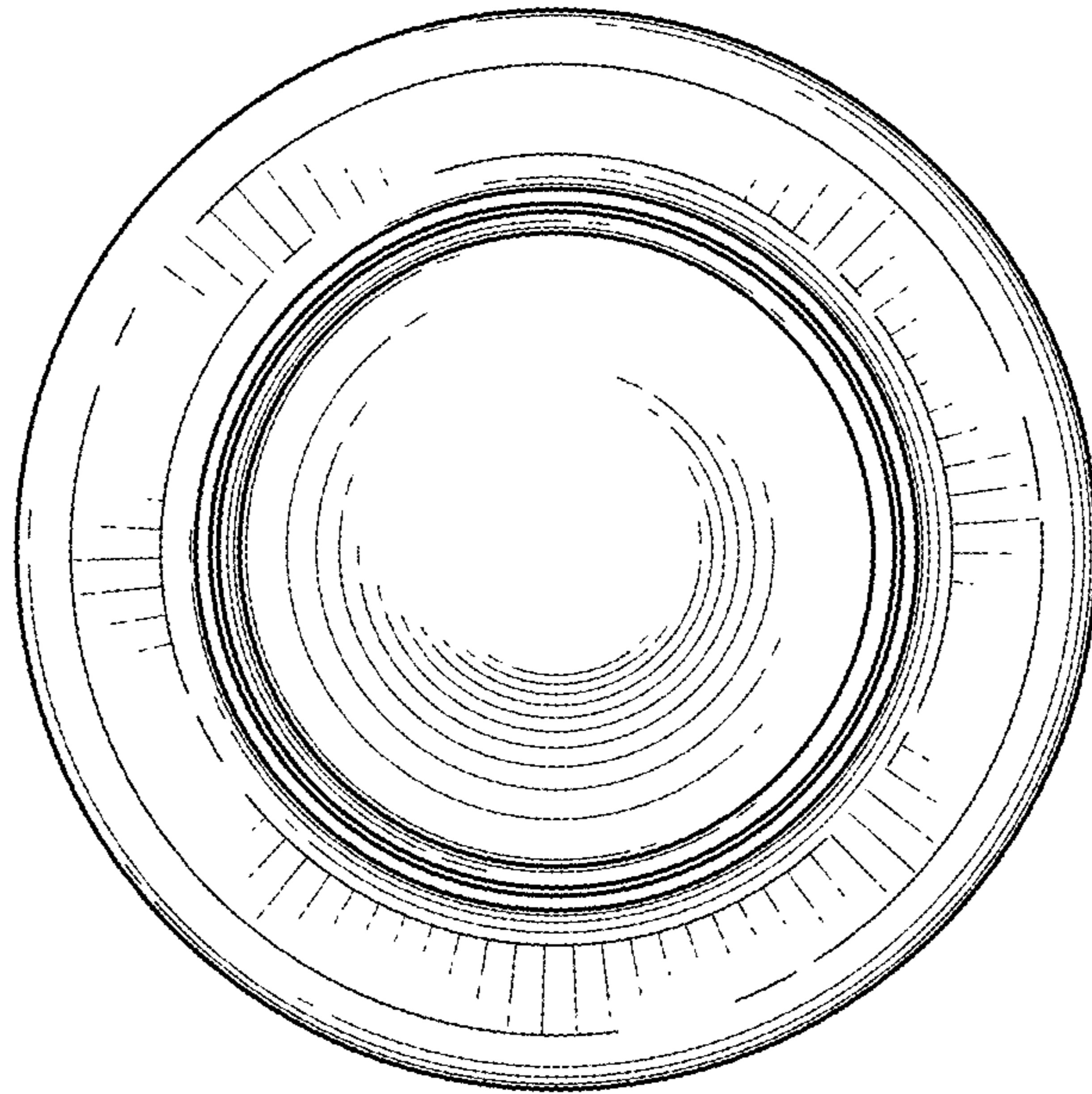

FIG. 14

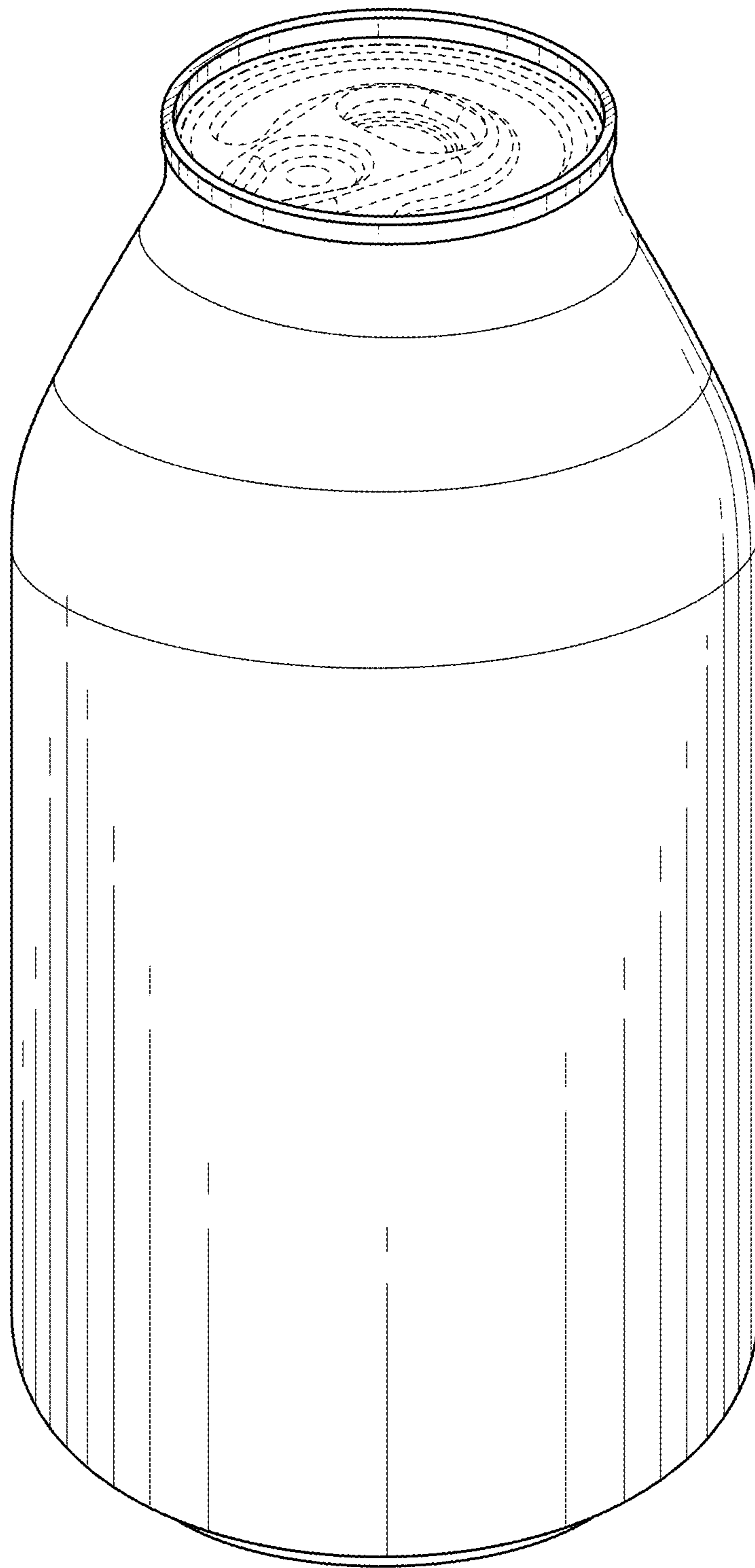

FIG. 15

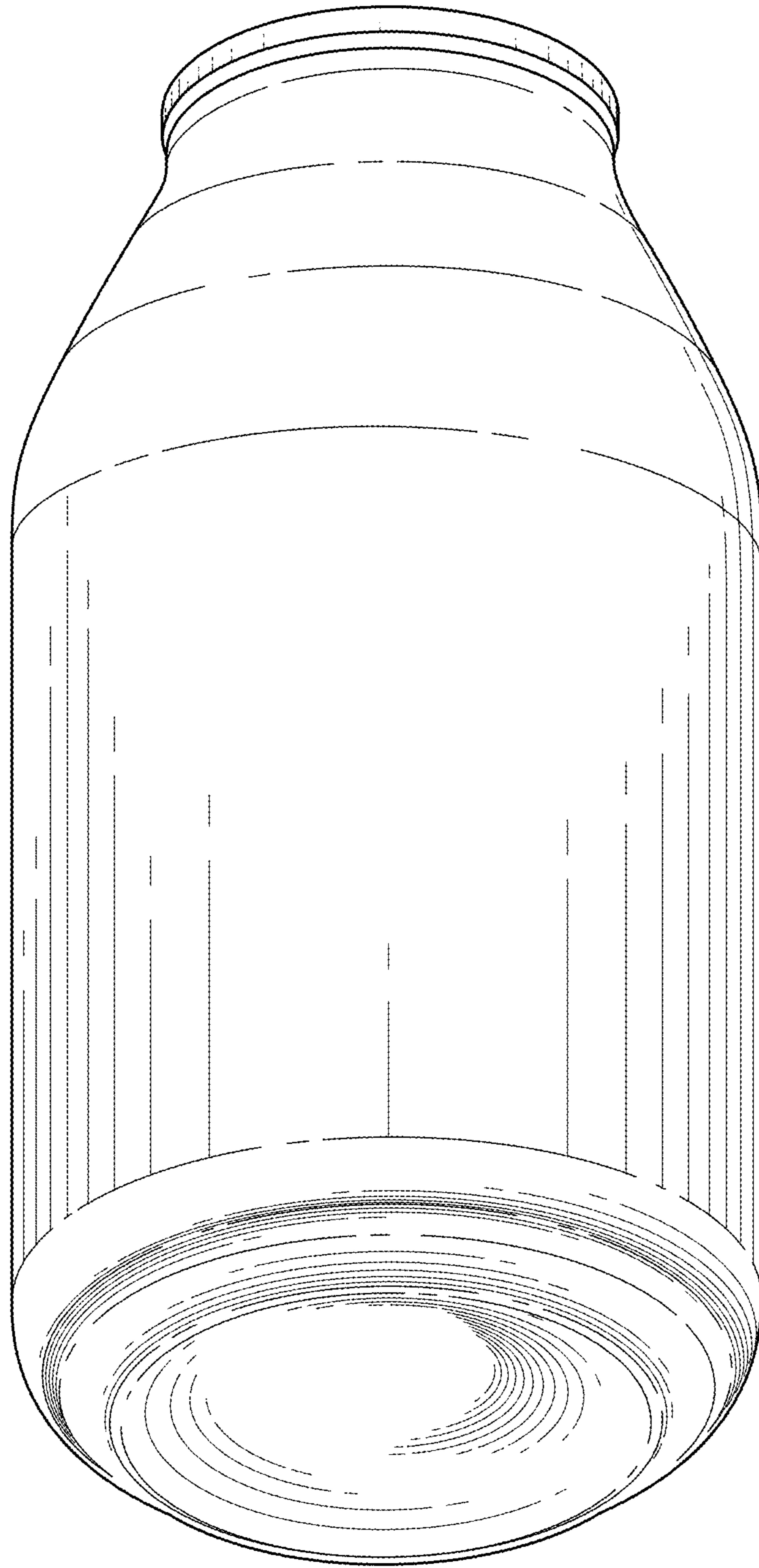

FIG. 16

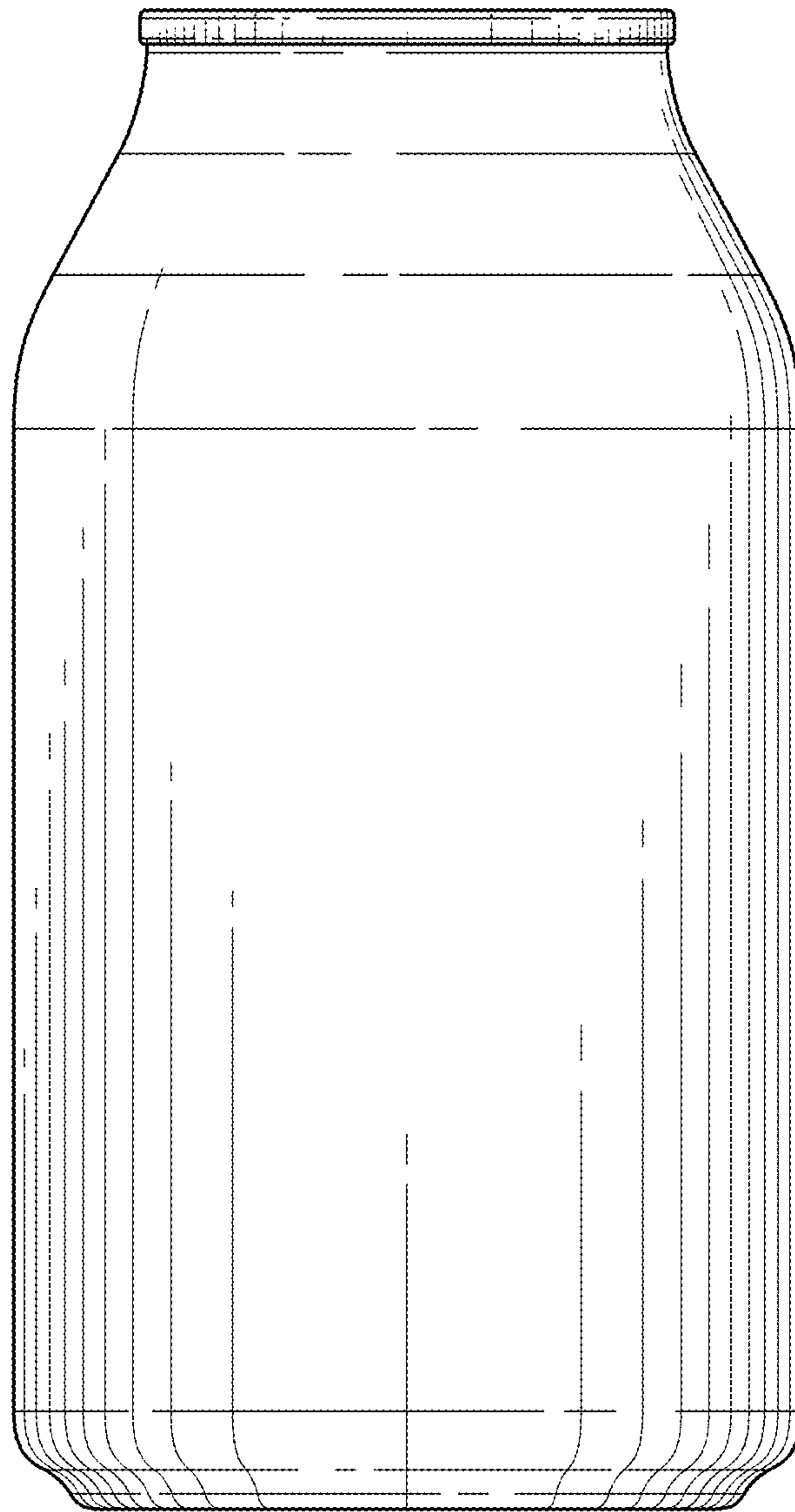

FIG. 17

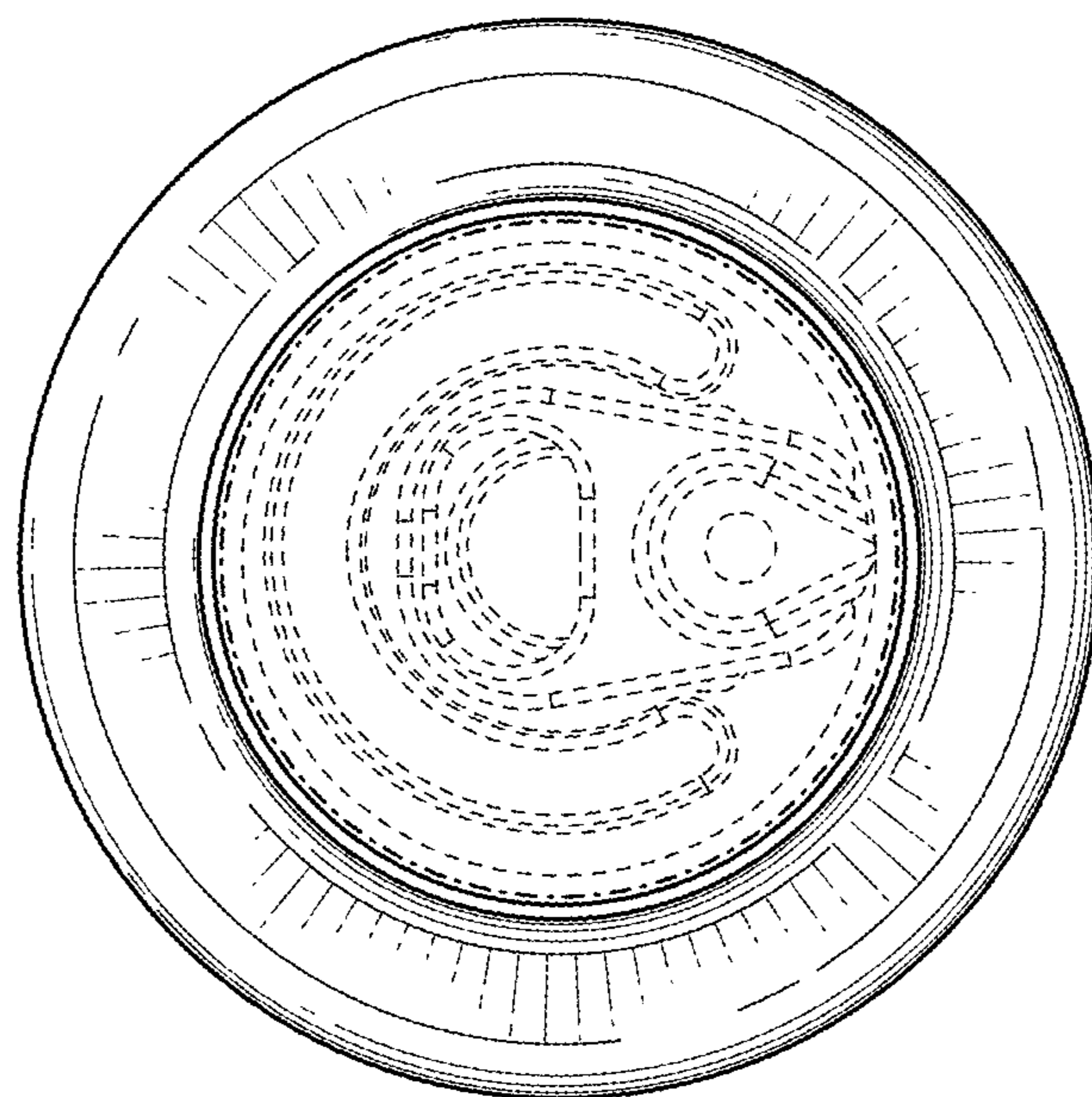

FIG. 18

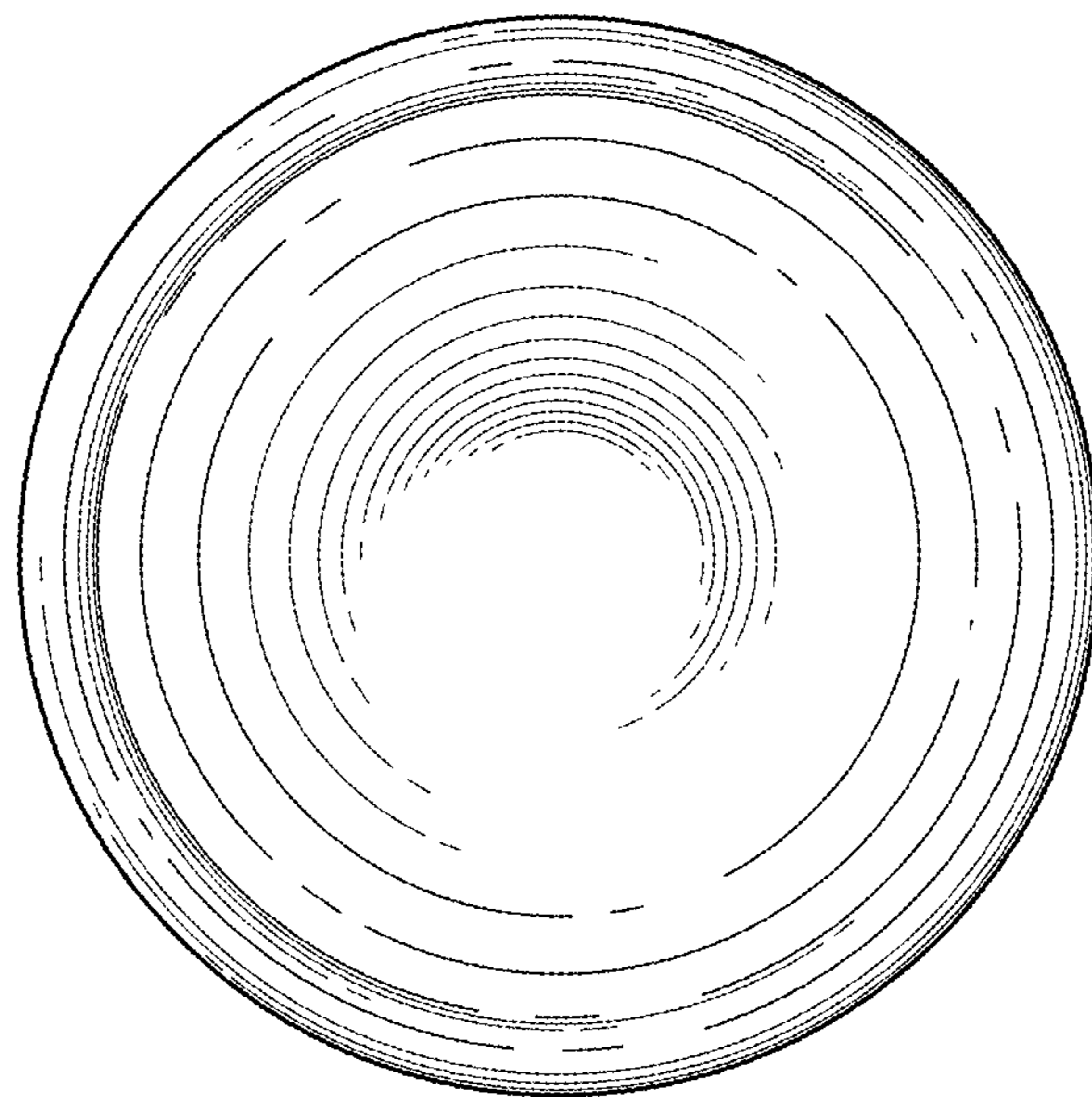

FIG. 19

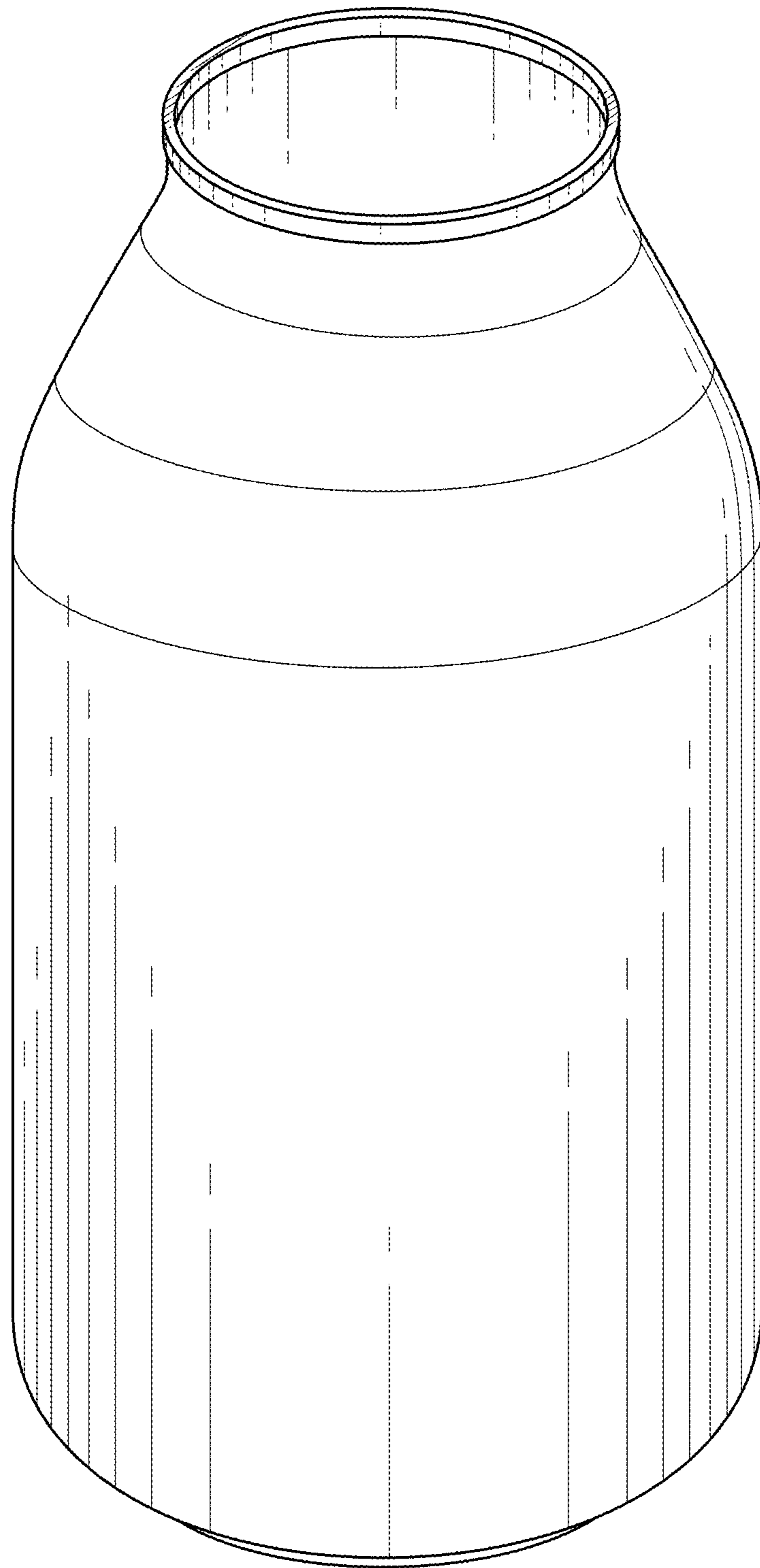

FIG. 20

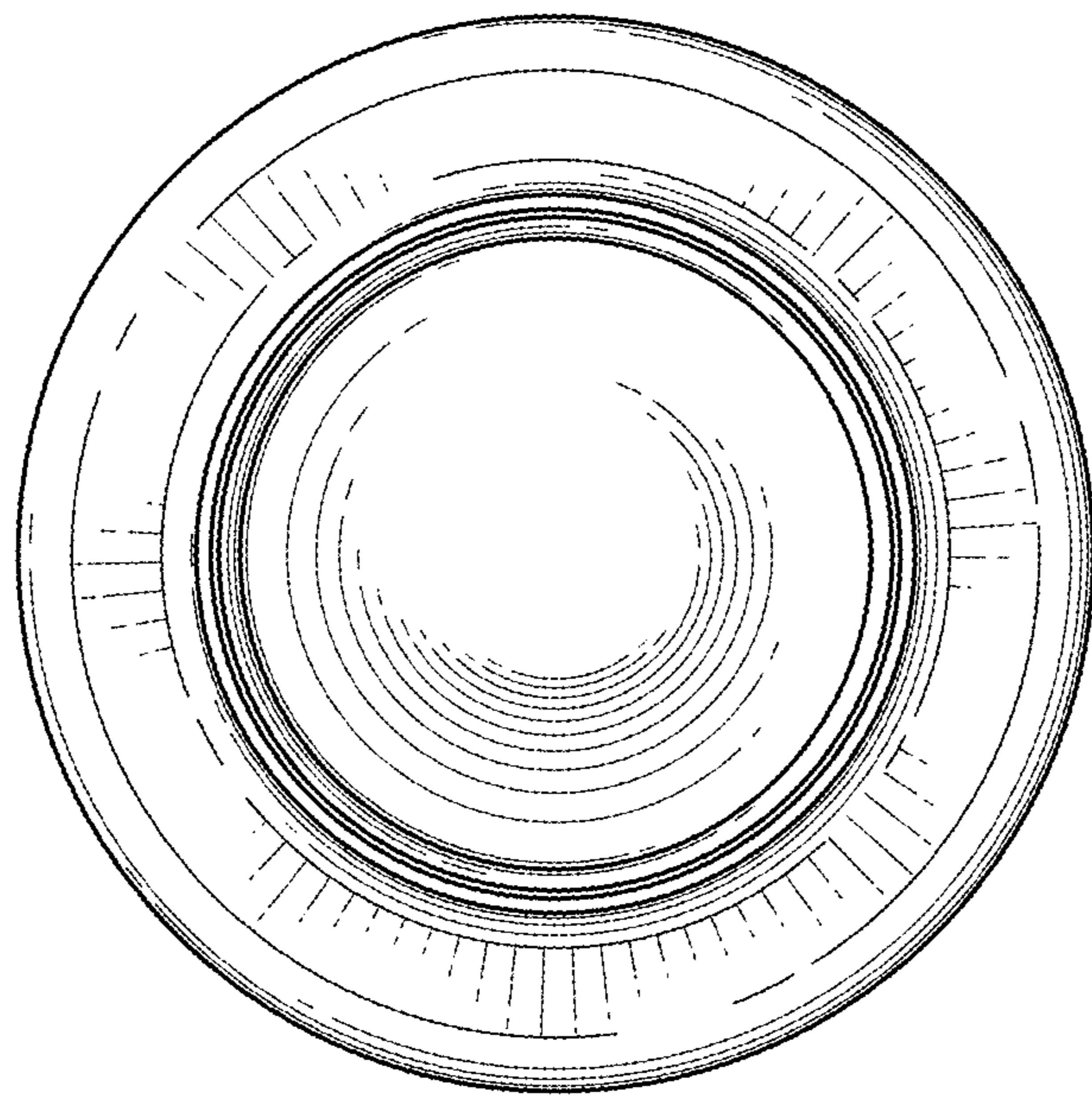

FIG. 21

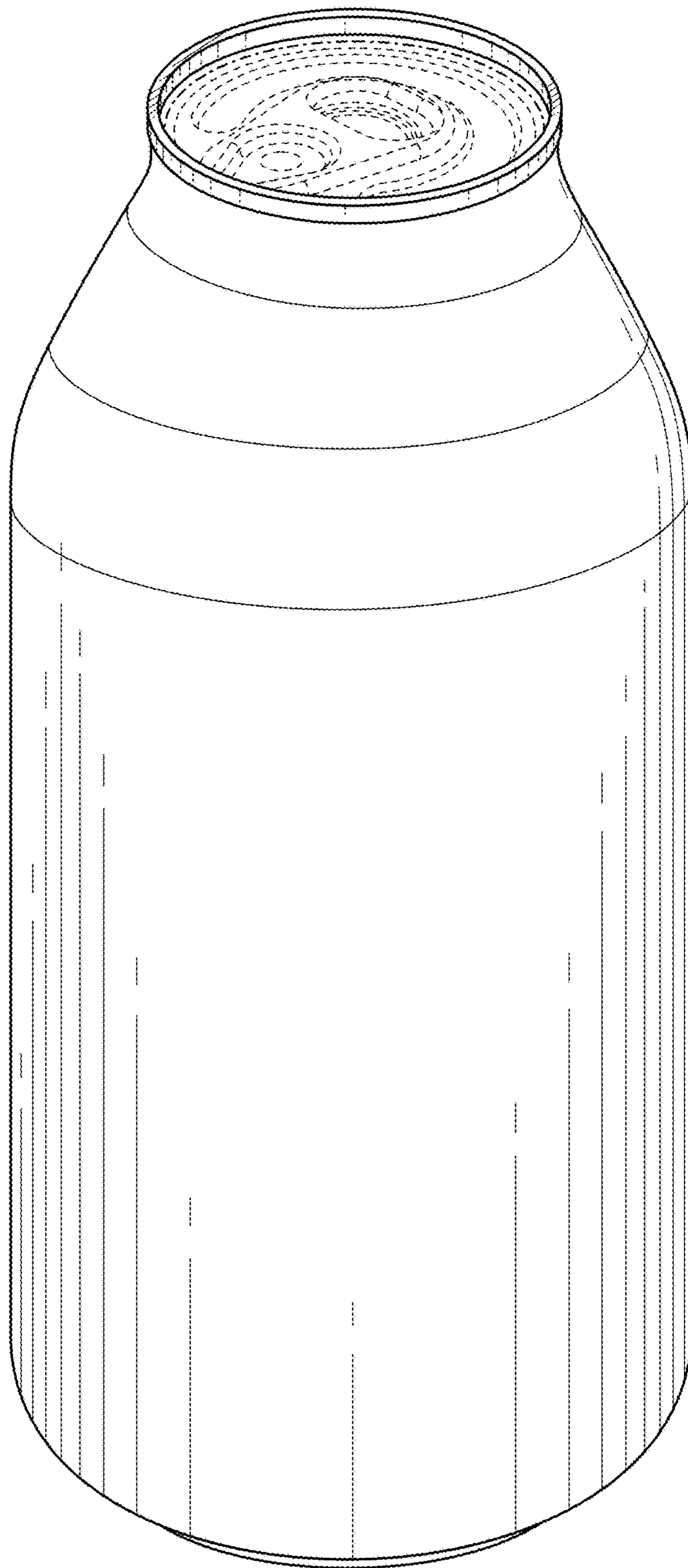

FIG. 22

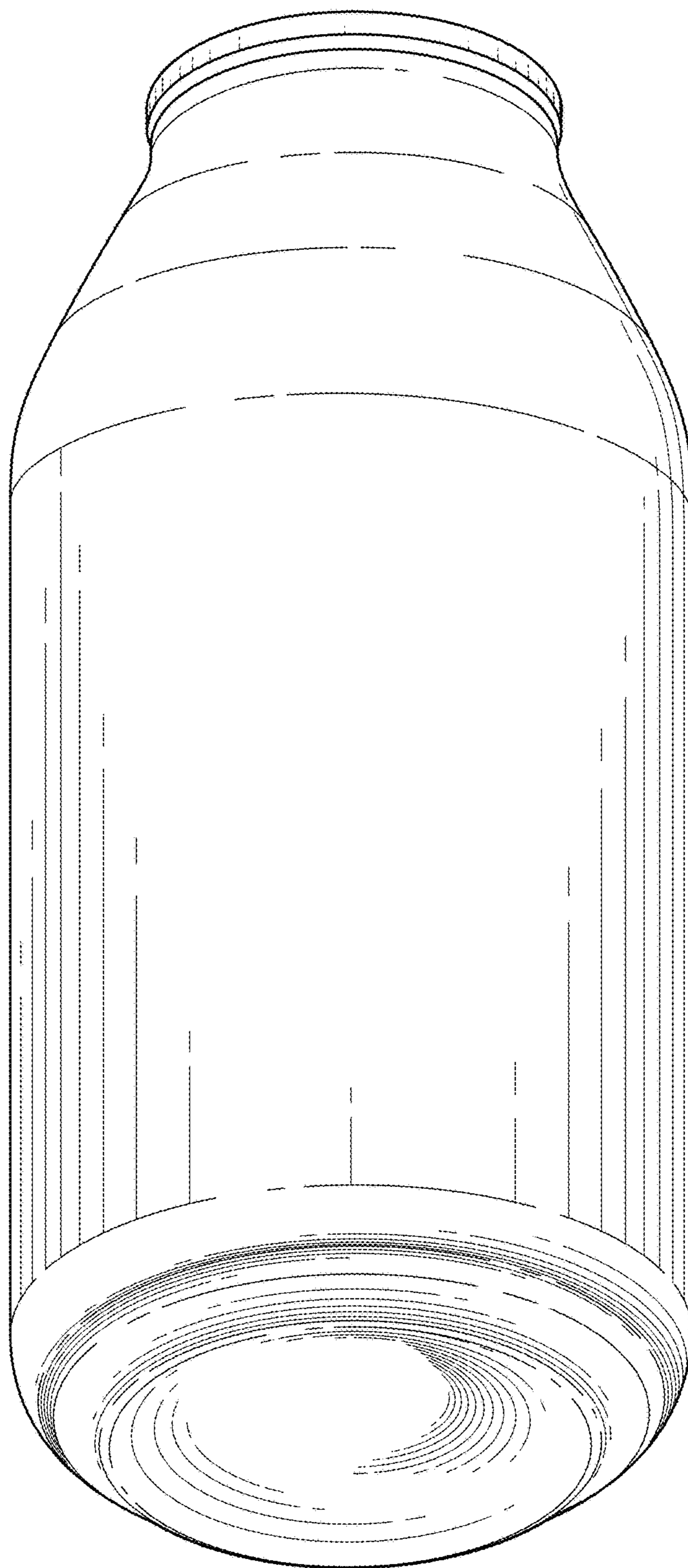

FIG. 23

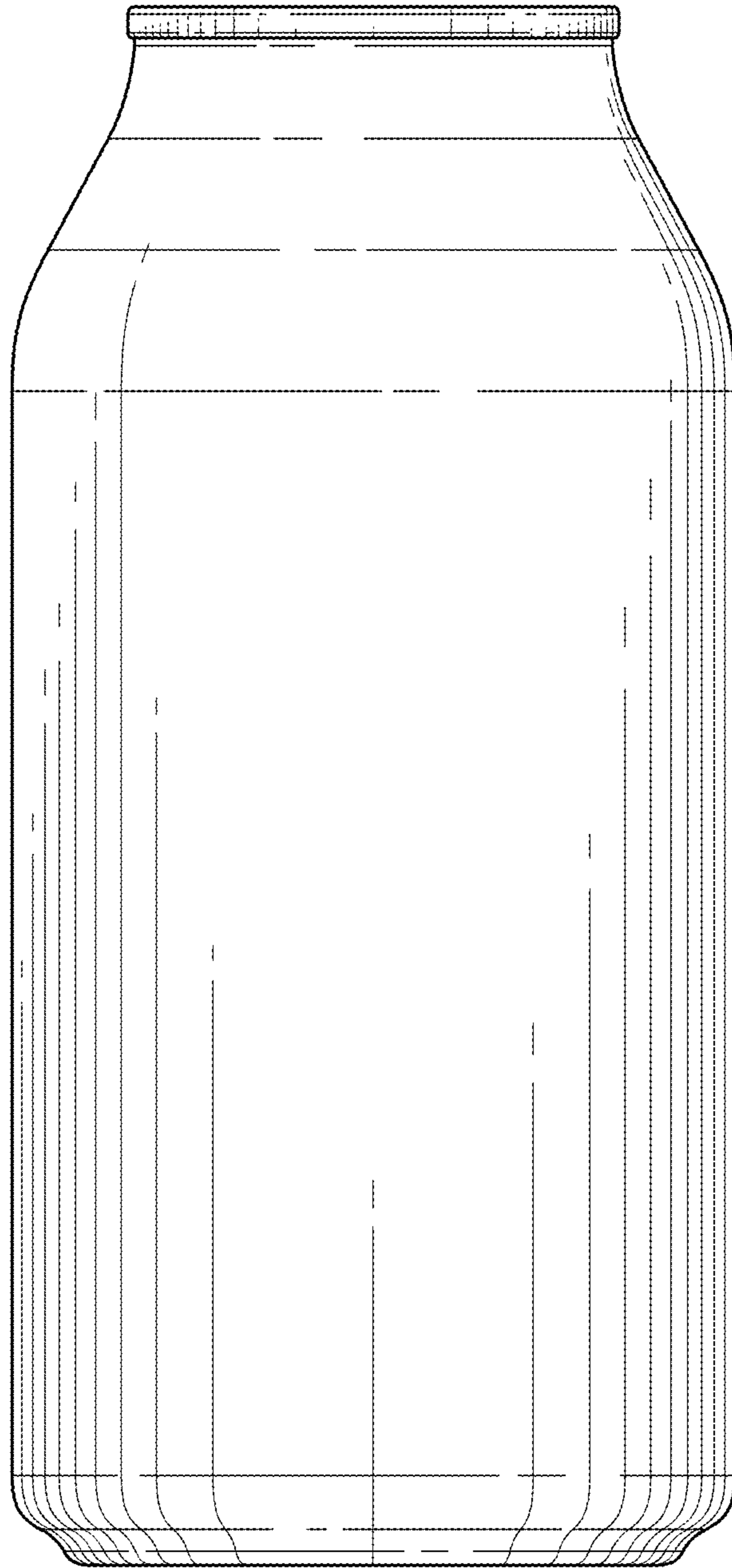

FIG. 24

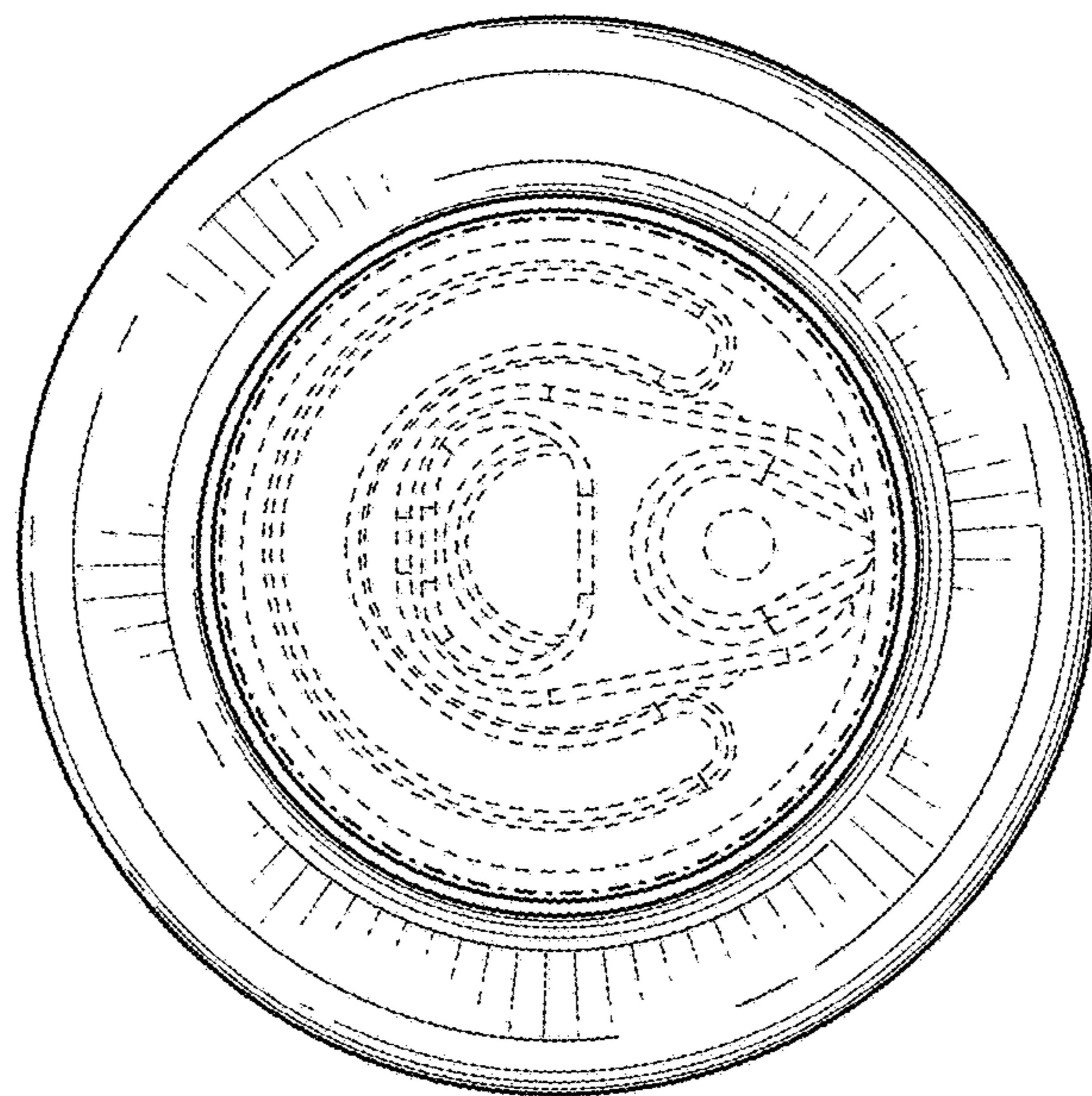

FIG. 25

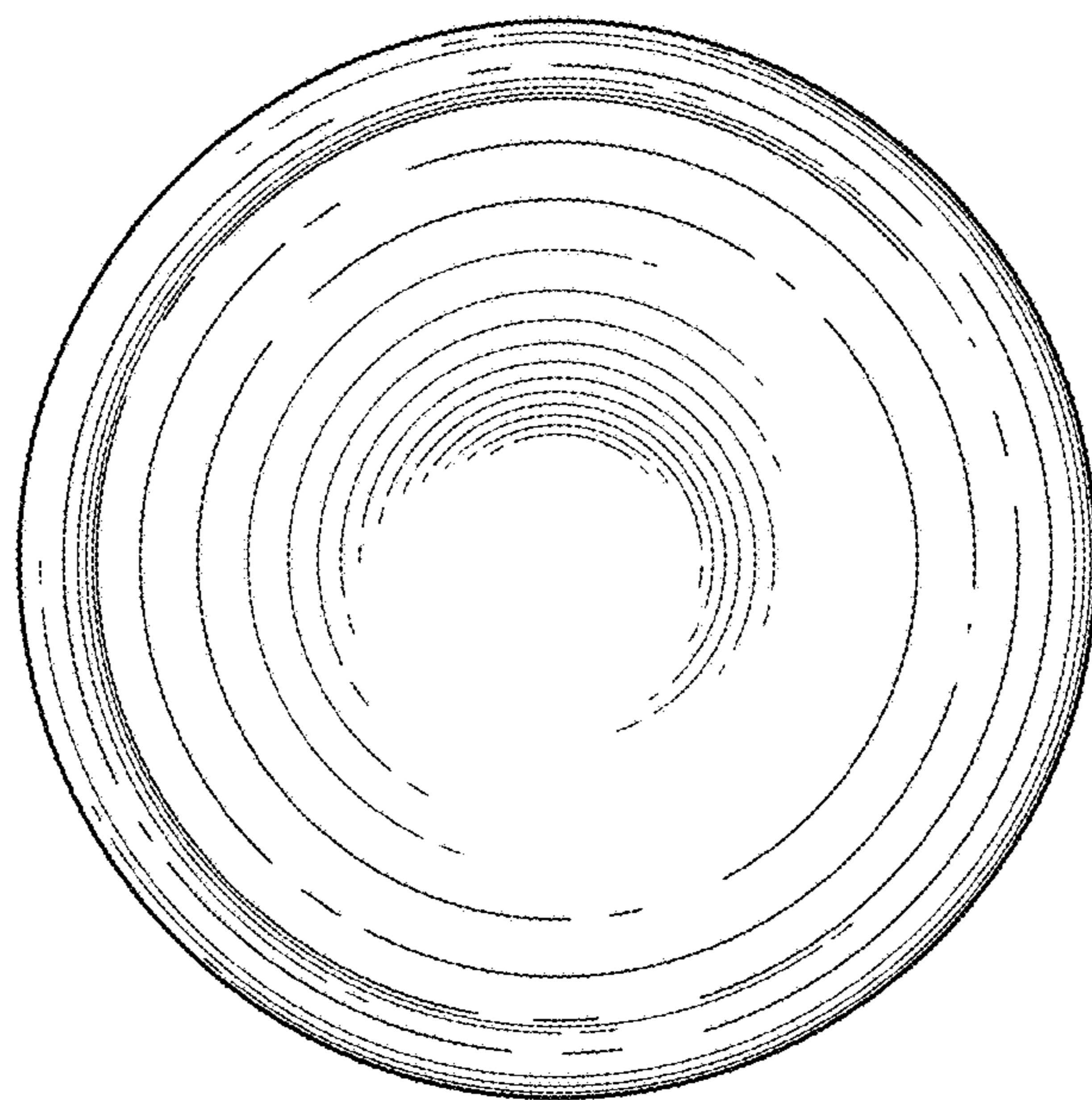

FIG. 26

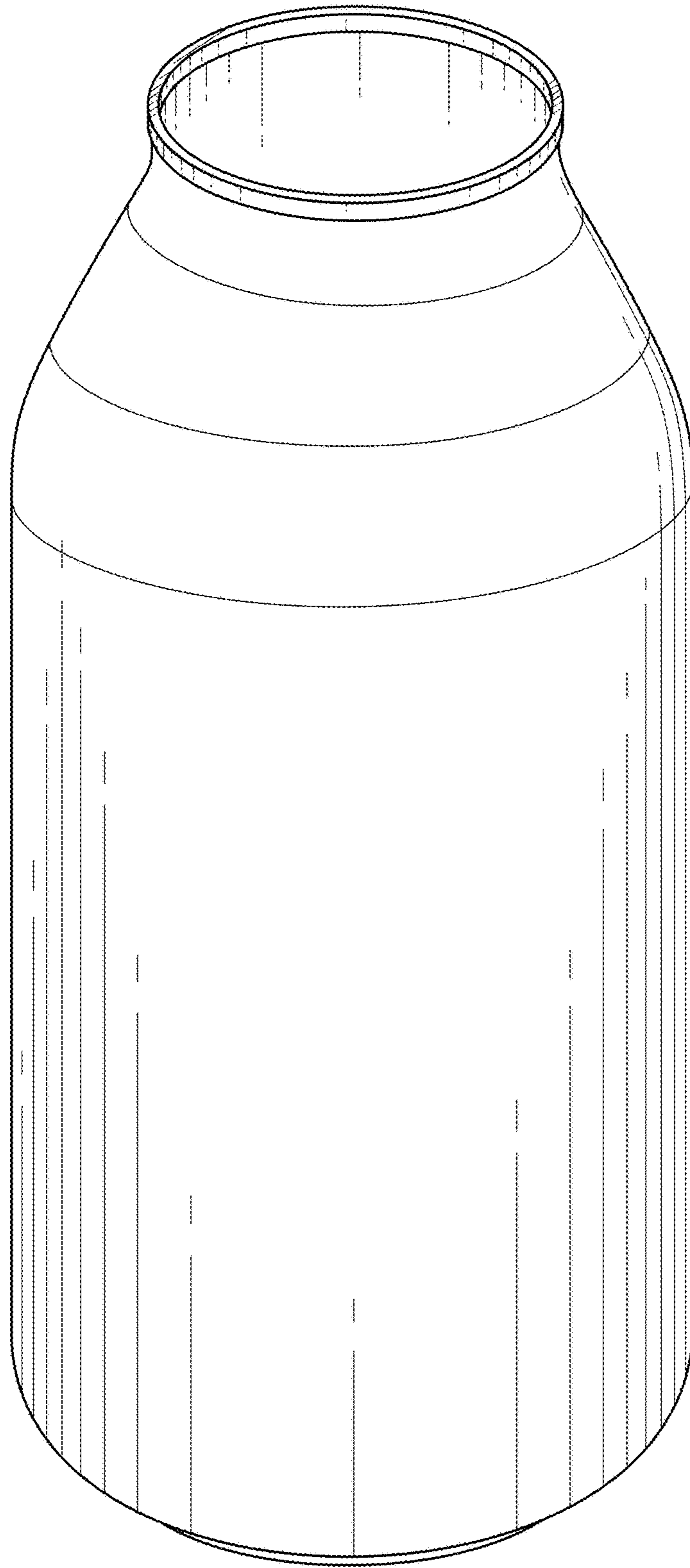

FIG. 27

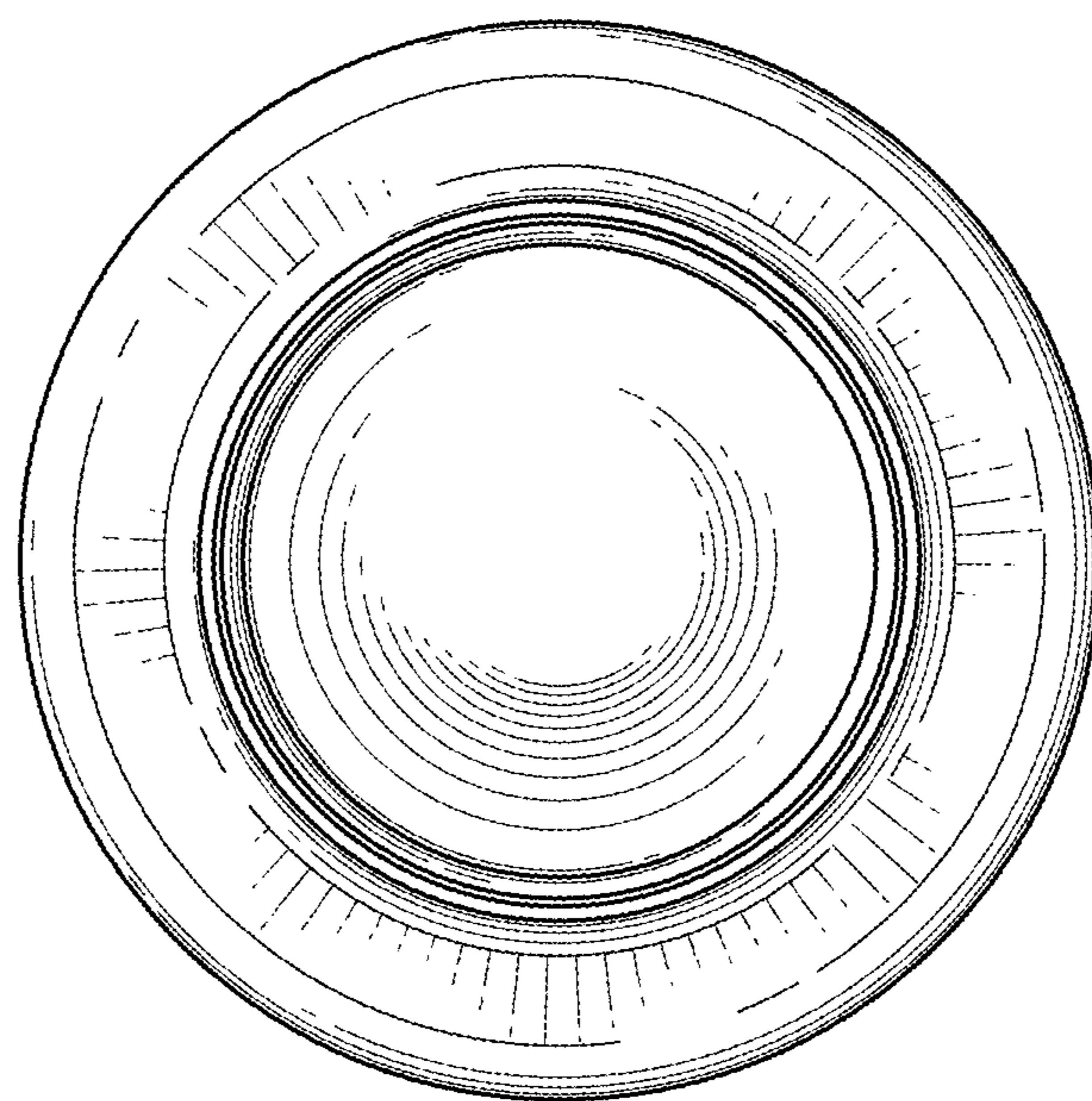

FIG. 28

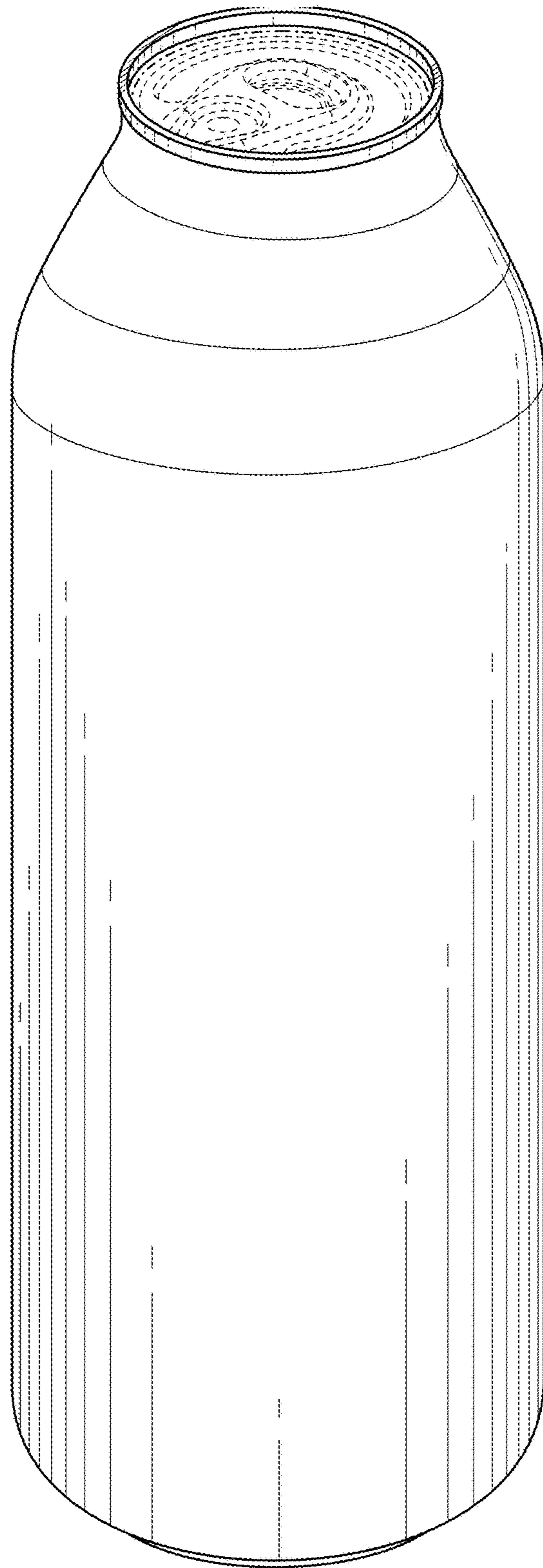

FIG. 29

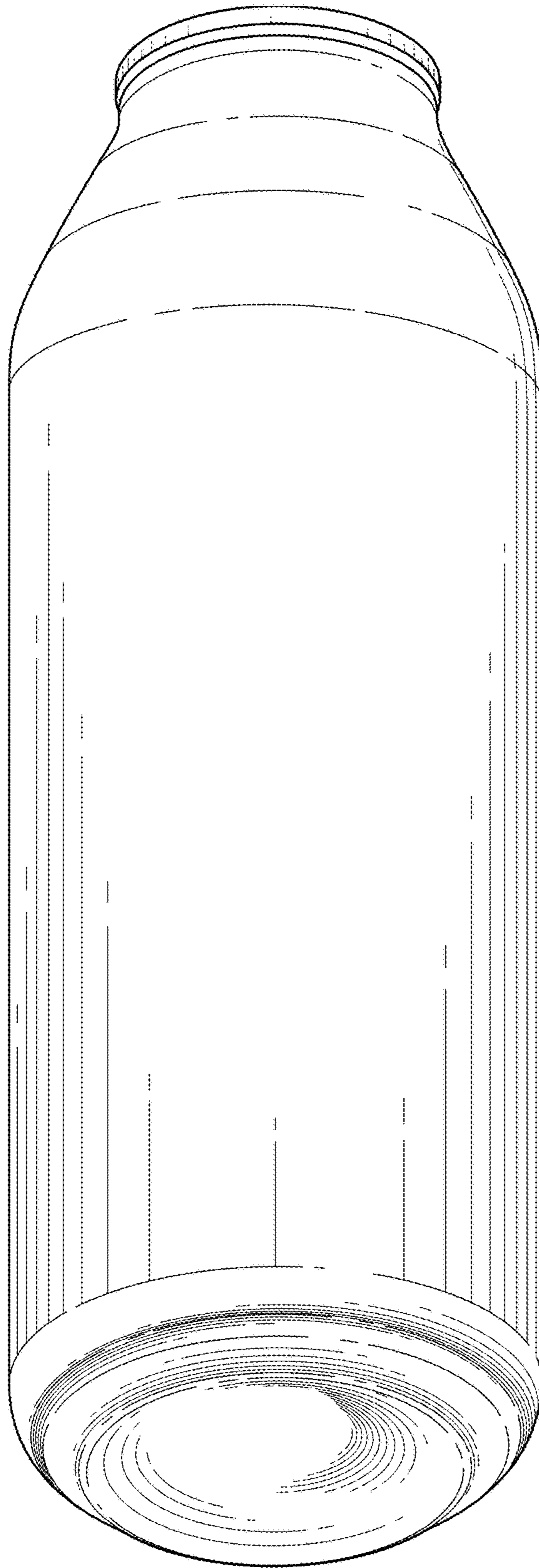

FIG. 30

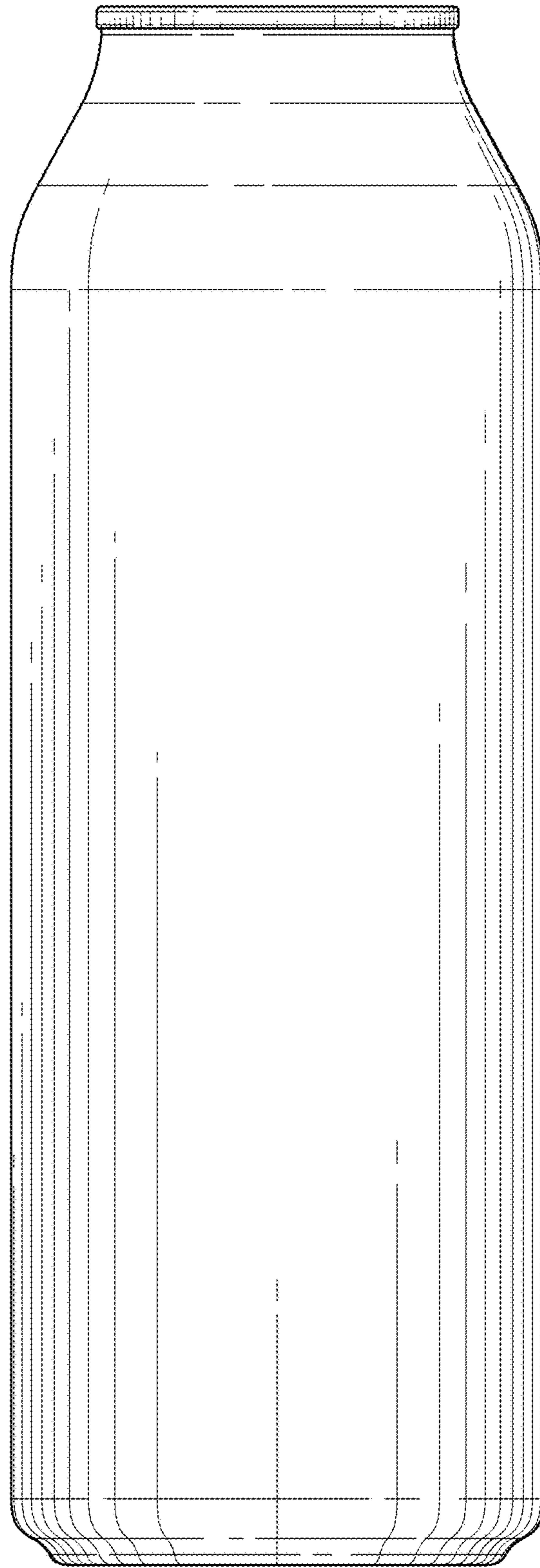

FIG. 31

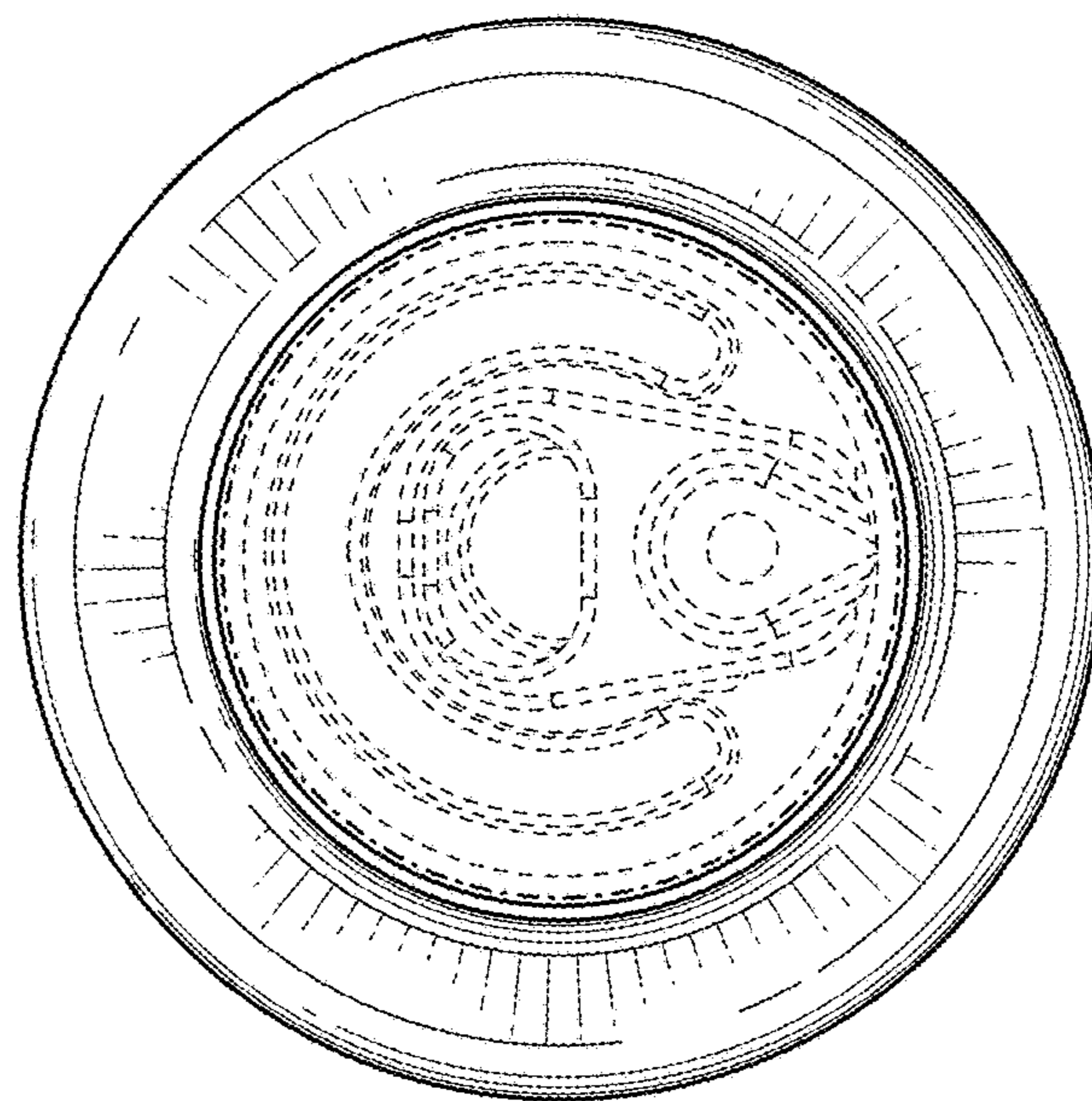

FIG. 32

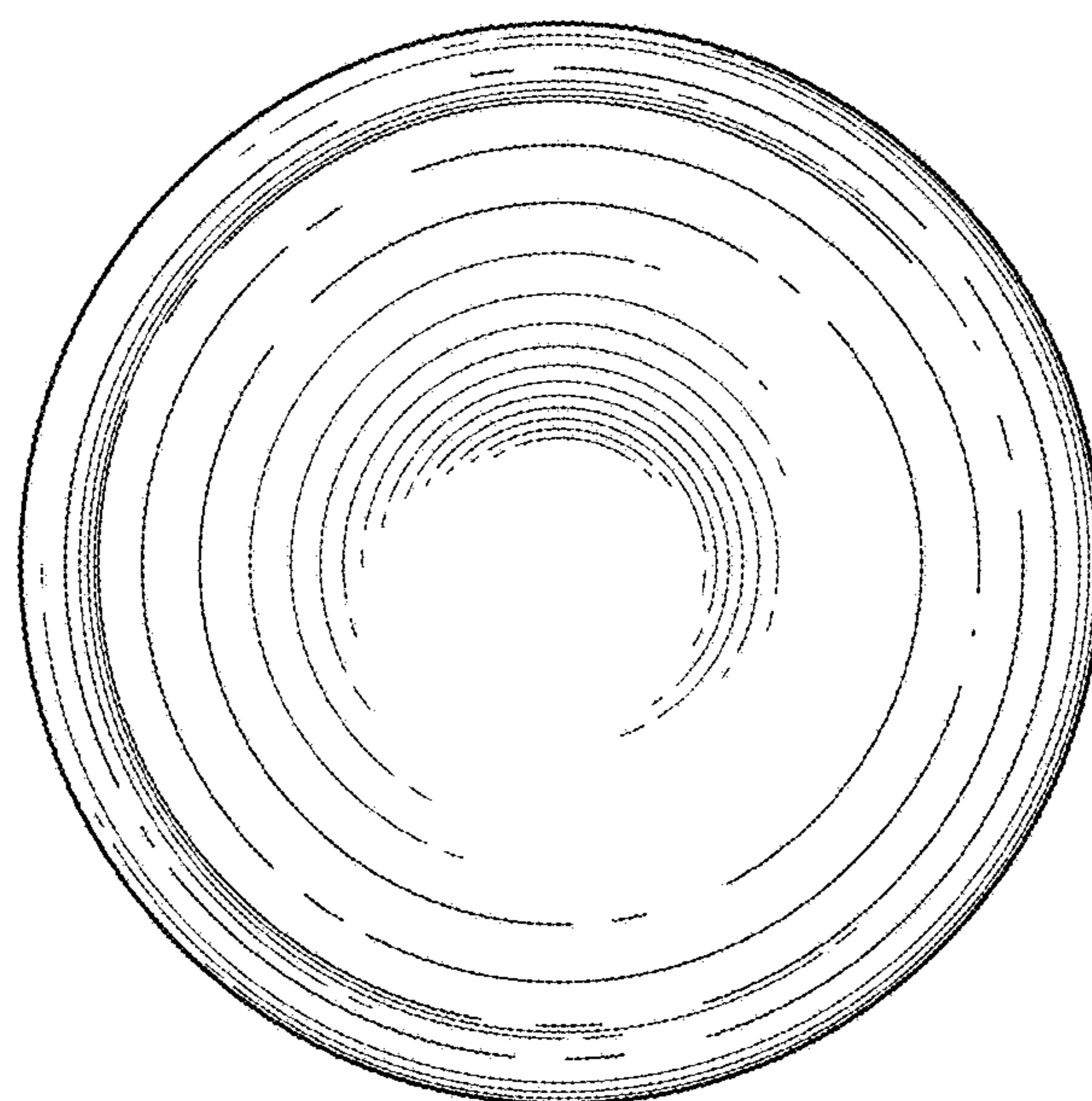

FIG. 33

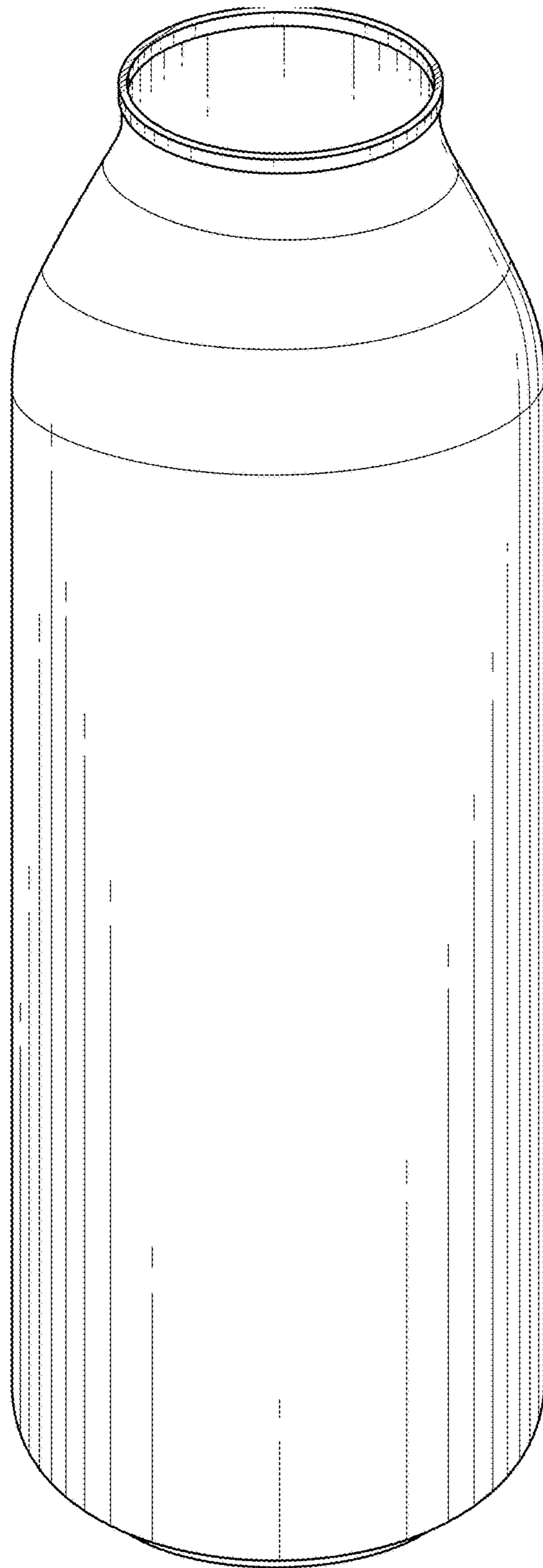

FIG. 34

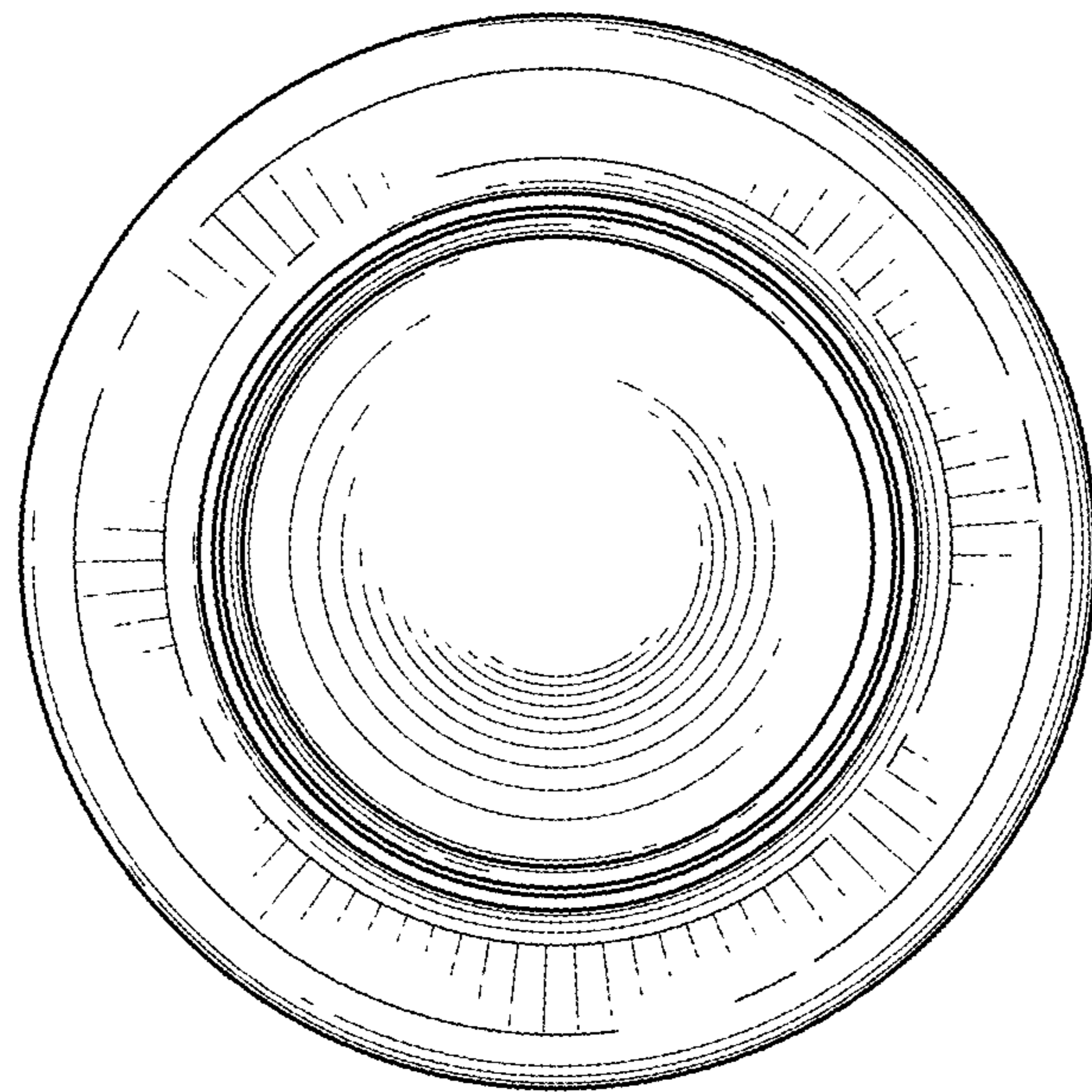

FIG. 35