



US00D772651S

(12) **United States Design Patent**  
**Leonard et al.**

(10) **Patent No.:** **US D772,651 S**  
(45) **Date of Patent:** **\*\* Nov. 29, 2016**

- (54) **BEVERAGE CONTAINER**
- (71) Applicant: **Telebrands Corp.**, Fairfield, NJ (US)
- (72) Inventors: **Cara Leonard**, Little Falls, NJ (US);  
**Norman L. Barrigas**, Danbury, CT (US); **Paul Dowd**, Scarsdale, NY (US)
- (73) Assignee: **Telebrands Corp.**, Fairfield, NJ (US)
- (\*\*) Term: **14 Years**

D457,034 S	5/2002	Bodum	
D457,783 S	5/2002	Bodum	
D458,081 S	6/2002	Bodum	
6,409,038 B1	6/2002	Karp	
D470,638 S *	2/2003	Quan	..... D34/7
D479,437 S	9/2003	Gluck	
D479,671 S	9/2003	Gluck	
D481,590 S	11/2003	Lin	
D481,591 S	11/2003	Lin	
D482,238 S	11/2003	Lin	
D483,611 S *	12/2003	Diak Ghanem	..... D7/510
D483,613 S	12/2003	Gluck	
D484,359 S	12/2003	Rohe	

(Continued)

(21) Appl. No.: **29/522,311**

(22) Filed: **Mar. 30, 2015**

(51) **LOC (10) Cl.** ..... **07-01**

(52) **U.S. Cl.**  
USPC ..... **D7/510**; D75/511; D75/532

(58) **Field of Classification Search**  
USPC ..... D7/507-512, 523, 528-532, 543, 213,  
D7/316, 317, 589, 607, 608, 387, 392.1,  
D7/396.2, 400; D9/555, 556, 569, 453,  
D9/499, 447, 449, 428, 425, 417, 429;  
D8/499, 391, 393, 373; 220/669, 737,  
220/675, 592.17; 206/520; D17/20, 99;  
D21/385, 386; D28/39, 41, 43, 34, 65,  
D28/56, 57, 59, 62

CPC ..... A47G 19/2272; A47G 19/2216;  
A47G 19/22; B65D 1/265; B65D 3/06;  
B65D 41/62; B65D 2543/00351; B65D  
2543/00046

See application file for complete search history.

(56) **References Cited**

**U.S. PATENT DOCUMENTS**

4,738,373 A *	4/1988	DeParales	..... B65D 43/0256 220/254.3
D454,755 S	3/2002	Jorgensen	
D456,672 S	5/2002	Bodum	

**OTHER PUBLICATIONS**

The MightyMug, available at: [shop.themightymug.com](http://shop.themightymug.com), accessed on Feb. 3, 2015.

(Continued)

*Primary Examiner* — Marianne Pandozzi  
*Assistant Examiner* — Jae Liang  
(74) *Attorney, Agent, or Firm* — Cooper & Dunham, LLP

(57) **CLAIM**

The ornamental design for a beverage container, as shown and described.

**DESCRIPTION**

FIG. 1 is a top perspective view of a beverage container showing our new design;  
FIG. 2 is a bottom perspective view thereof;  
FIG. 3 is a front view thereof;  
FIG. 4 is a rear view thereof;  
FIG. 5 is a right side view thereof;  
FIG. 6 is a left side view thereof;  
FIG. 7 is a top view thereof; and,  
FIG. 8 is a bottom view thereof.

**1 Claim, 5 Drawing Sheets**

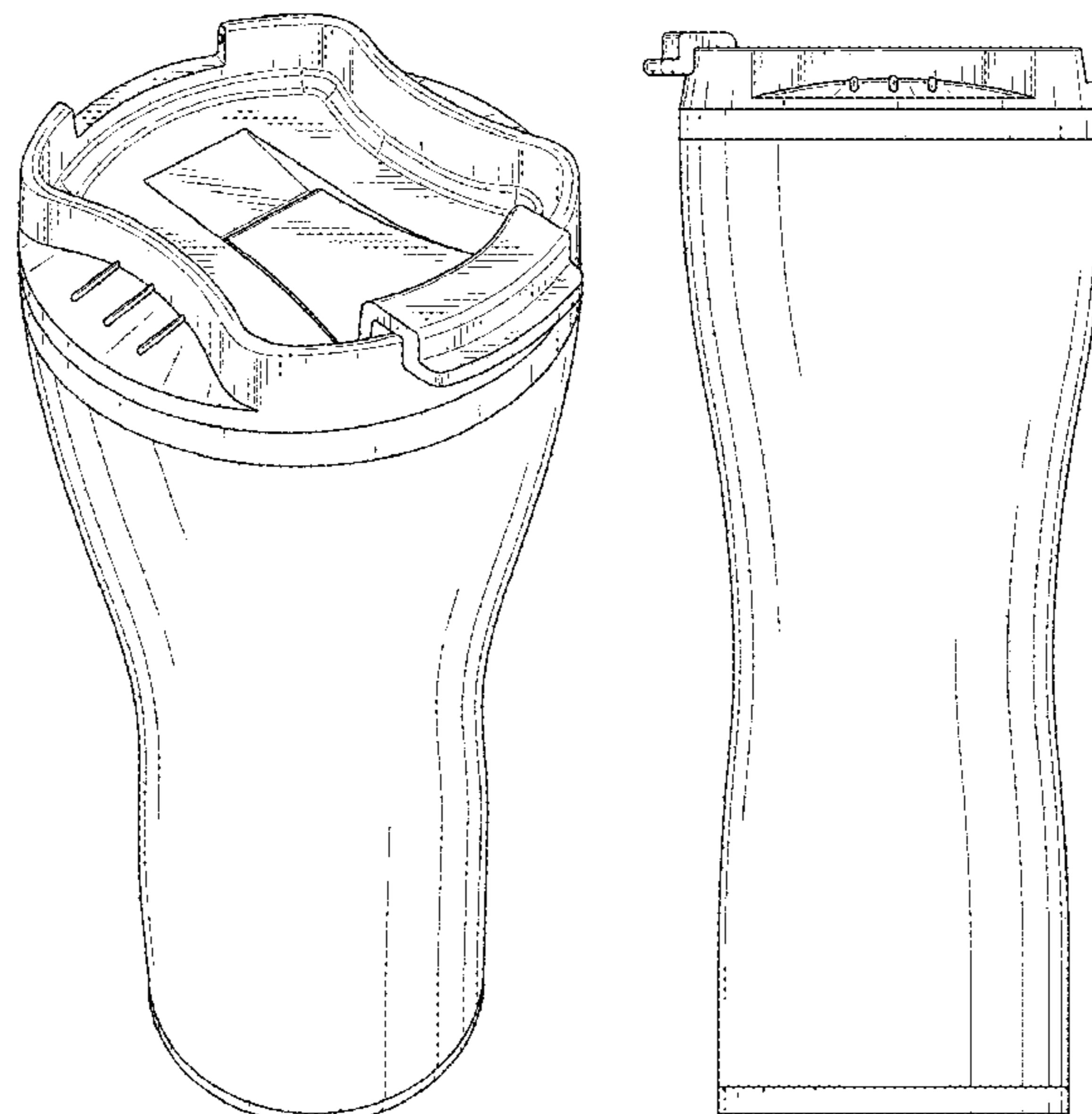

(56)

References Cited

U.S. PATENT DOCUMENTS

D485,759 S \* 1/2004 Janky ..... D7/392.1  
 D490,272 S 5/2004 Rohe  
 D490,652 S 6/2004 Xiong  
 D492,157 S 6/2004 Bodum  
 D492,158 S 6/2004 Bodum  
 D492,546 S 7/2004 Bodum  
 D494,815 S 8/2004 Bodum  
 6,852,954 B1 2/2005 Liu et al.  
 D502,844 S 3/2005 Rohe  
 D509,135 S \* 9/2005 Guyot ..... D9/447  
 D512,269 S 12/2005 Trombly  
 D533,403 S 12/2006 Bhavnani  
 D540,674 S \* 4/2007 Hollis ..... D9/435  
 D543,416 S 5/2007 Gluck  
 D544,304 S 6/2007 Gluck  
 D545,128 S 6/2007 Liu et al.  
 D546,625 S 7/2007 Gluck  
 D547,122 S 7/2007 Gluck  
 D554,433 S 11/2007 Gluck  
 D554,435 S 11/2007 Carreno et al.  
 D562,065 S 2/2008 Smaldone  
 D570,685 S \* 6/2008 Koennecke ..... D9/447  
 D611,764 S \* 3/2010 Wahl ..... D7/316  
 D644,060 S \* 8/2011 Komeiji ..... D7/392.1  
 D648,599 S \* 11/2011 Watanabe ..... D7/509  
 D691,416 S \* 10/2013 Eyal ..... D7/396.2  
 D696,586 S \* 12/2013 Huang ..... D7/511  
 D698,602 S \* 2/2014 Beller ..... D7/396.2  
 D711,741 S \* 8/2014 Humm ..... D9/447  
 D712,701 S \* 9/2014 Boroski ..... D7/533  
 D739,233 S \* 9/2015 Antal, Sr. .... D9/435  
 D756,705 S \* 5/2016 Abrams ..... D7/510  
 2009/0071969 A1 \* 3/2009 Lopez ..... A47G 19/22  
 2009/0266828 A1 \* 10/2009 Cai ..... B65D 43/0212  
 2015/0216341 A1 \* 8/2015 Shimono ..... B65D 85/72  
 220/592.17  
 220/712  
 220/253

OTHER PUBLICATIONS

Bodum, available at: [bodum.bodum.com/us/en-us/shop/prodlist264](http://bodum.bodum.com/us/en-us/shop/prodlist264), accessed on Jan. 23, 2015.  
 Mugs & Tumblers, available at: [www.thermos.com/product\\_catalog.aspx?CatCode=MUGS](http://www.thermos.com/product_catalog.aspx?CatCode=MUGS), accessed on Jan. 23, 2015.  
 Tumblers & Travel Mugs, available at: [store.starbucks.com/drinkware/tumbler-and-travel-mugs](http://store.starbucks.com/drinkware/tumbler-and-travel-mugs), accessed on Jan. 23, 2015.  
 Contigo Travel Mugs, available at: [www.gocontigo.com](http://www.gocontigo.com), accessed on Jan. 23, 2015.  
 Trudeau Erin 16-ounce Stainless Steel Travel Tumbler, available at [www.amazon.com](http://www.amazon.com), accessed on Jan. 23, 2015.  
 Thermos Stainless Steel 14 Ounce Travel Tumbler with 360 Degree Lid, available at: [www.amazon.com](http://www.amazon.com), accessed on Jan. 23, 2015.  
 Thermos 16Oz Stainless Steel Travel Mug, available at: [www.ebay.com](http://www.ebay.com), accessed on Jan. 23, 2015.  
 Bling Me Coffee Mug, available at [www.amazon.com](http://www.amazon.com), accessed on Jan. 23, 2015.  
 Paisley Pattern Stainless Steel Core with Ceramic Exterior 12 Ounce Travel Mug, available at [www.amazon.com](http://www.amazon.com), accessed on Jan. 23, 2015.  
 Stainless Steel Travel Twist Lid, available at: [www.amazon.com](http://www.amazon.com), accessed on Jan. 23, 2015.  
 Brugo Leak Proof Thermodynamic Trave Mug in Jazz Slice, available at: [www.walmart.com](http://www.walmart.com), accessed on Jan. 23, 2015.  
 Planetary Designs Vacuum Travel Tumbler, available at [www.amazon.com](http://www.amazon.com), accessed on Jan. 23, 2015.  
 Stainless Steel 14oz Bling Rhinestone Travel Mug, available at: [www.amazon.com](http://www.amazon.com), accessed on Jan. 23, 2015.  
 Stainless Travel Thermal Coffee Tumbler, available at: [www.amazon.com](http://www.amazon.com), accessed on Jan. 23, 2015.  
 Black & Decker Single Serve Coffee Maker, available at [www.amazon.com](http://www.amazon.com), accessed on Jan. 23, 2015.  
 16oz Cleo Tumbler Travel Mug by Migo, available at [www.amazon.com](http://www.amazon.com), accessed on Jan. 23, 2015.  
 Gorgeous Vera Bradley Travel Mug in Fanfare, available at [www.amazon.com](http://www.amazon.com), accessed on Jan. 23, 2015.

\* cited by examiner

FIG. 1

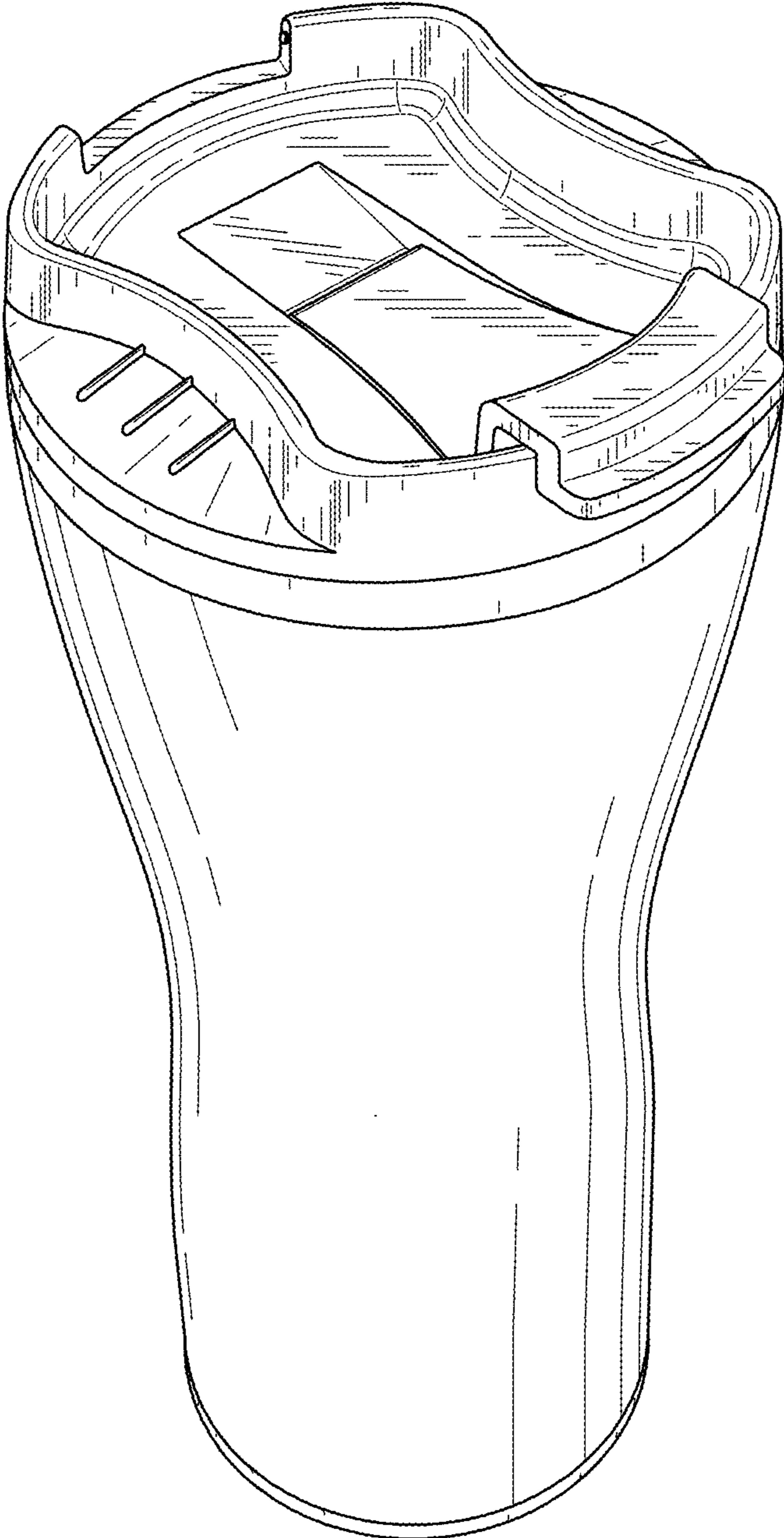



FIG. 2

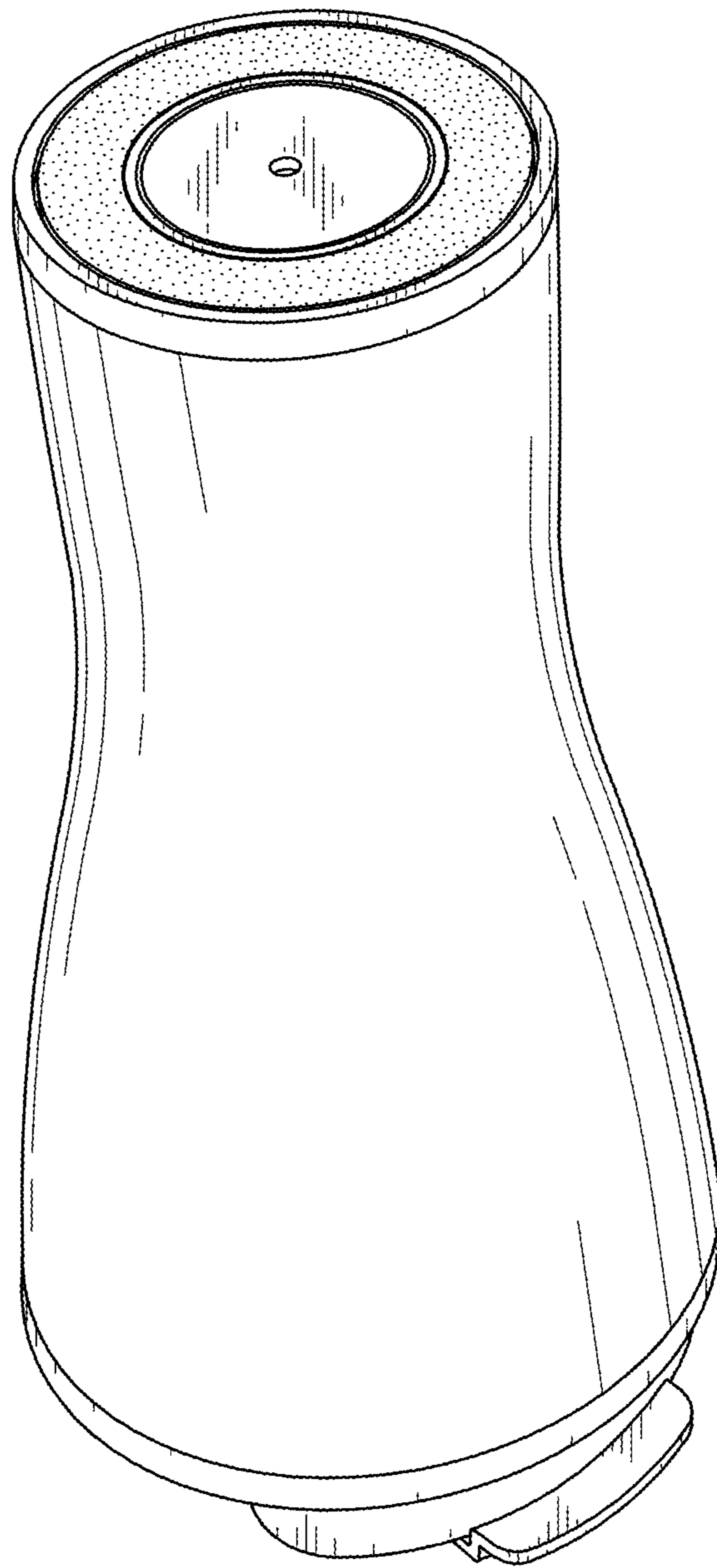

FIG. 3

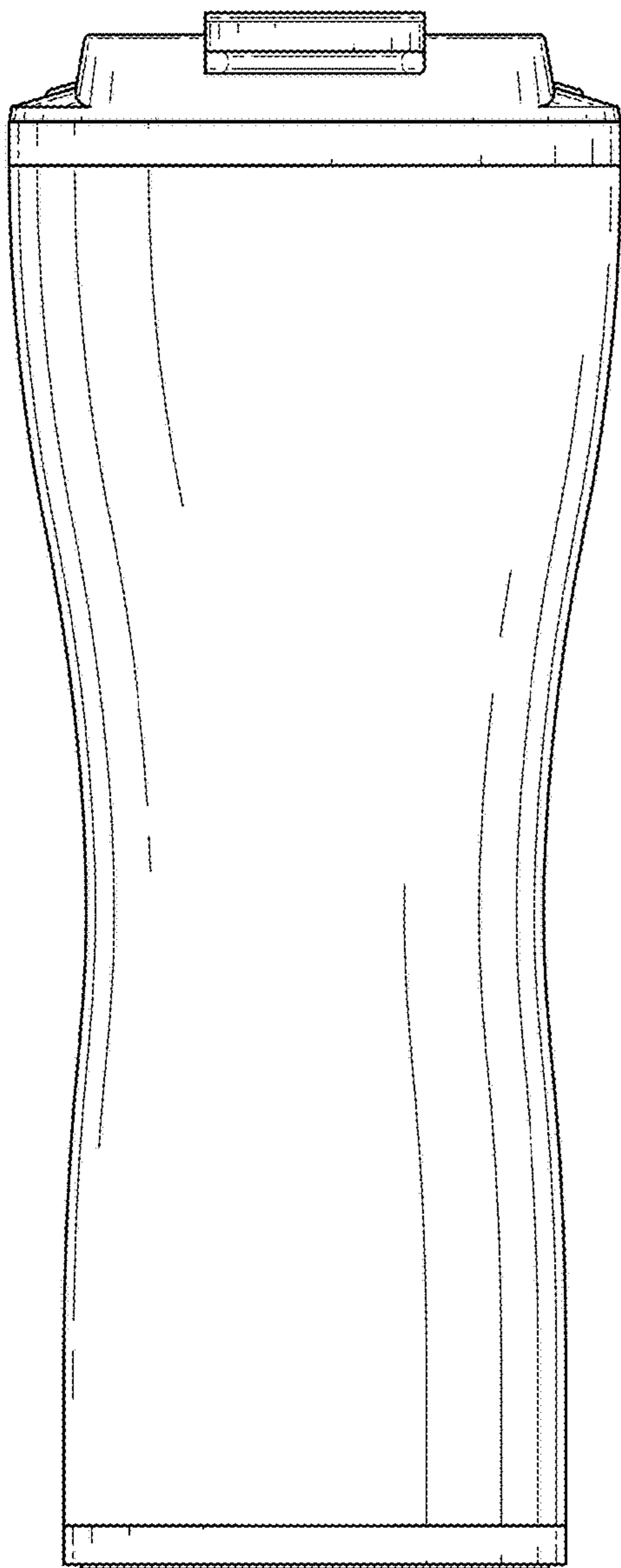

FIG. 4

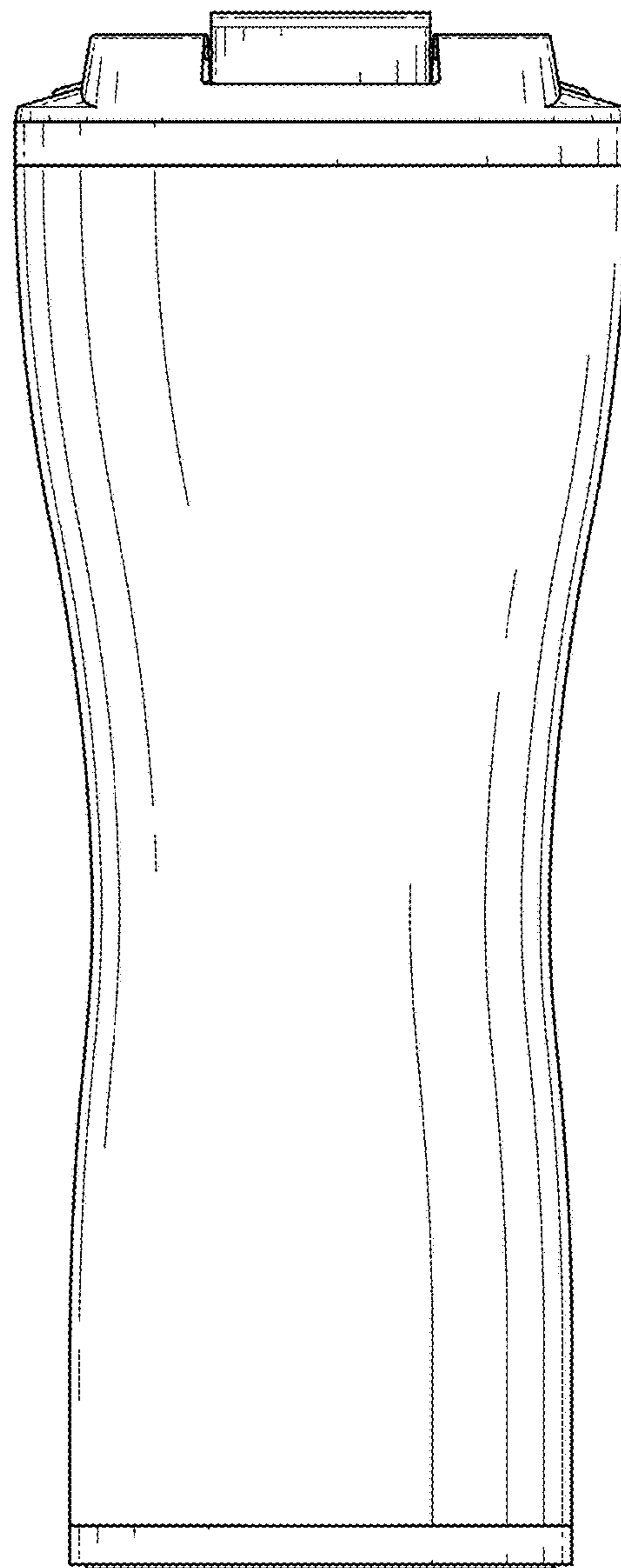

FIG. 5

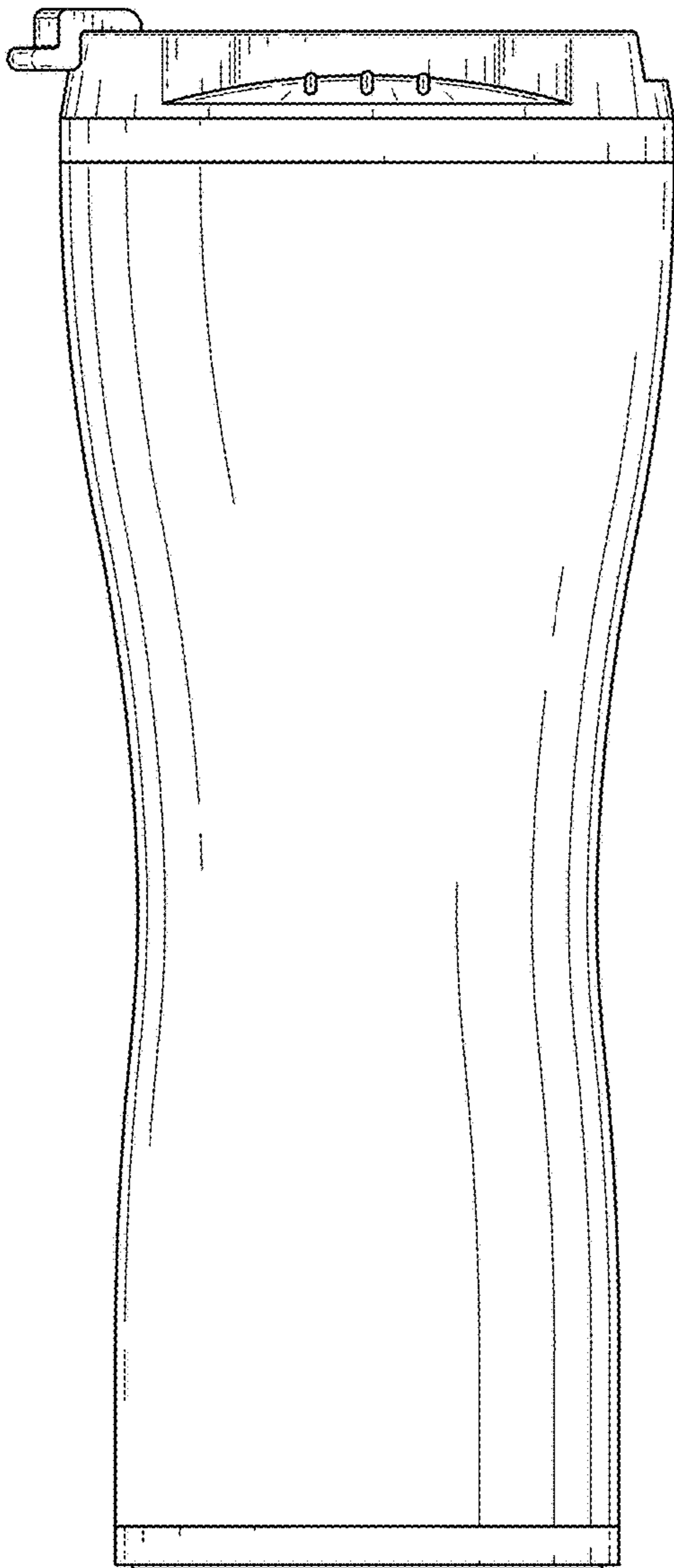

FIG. 6

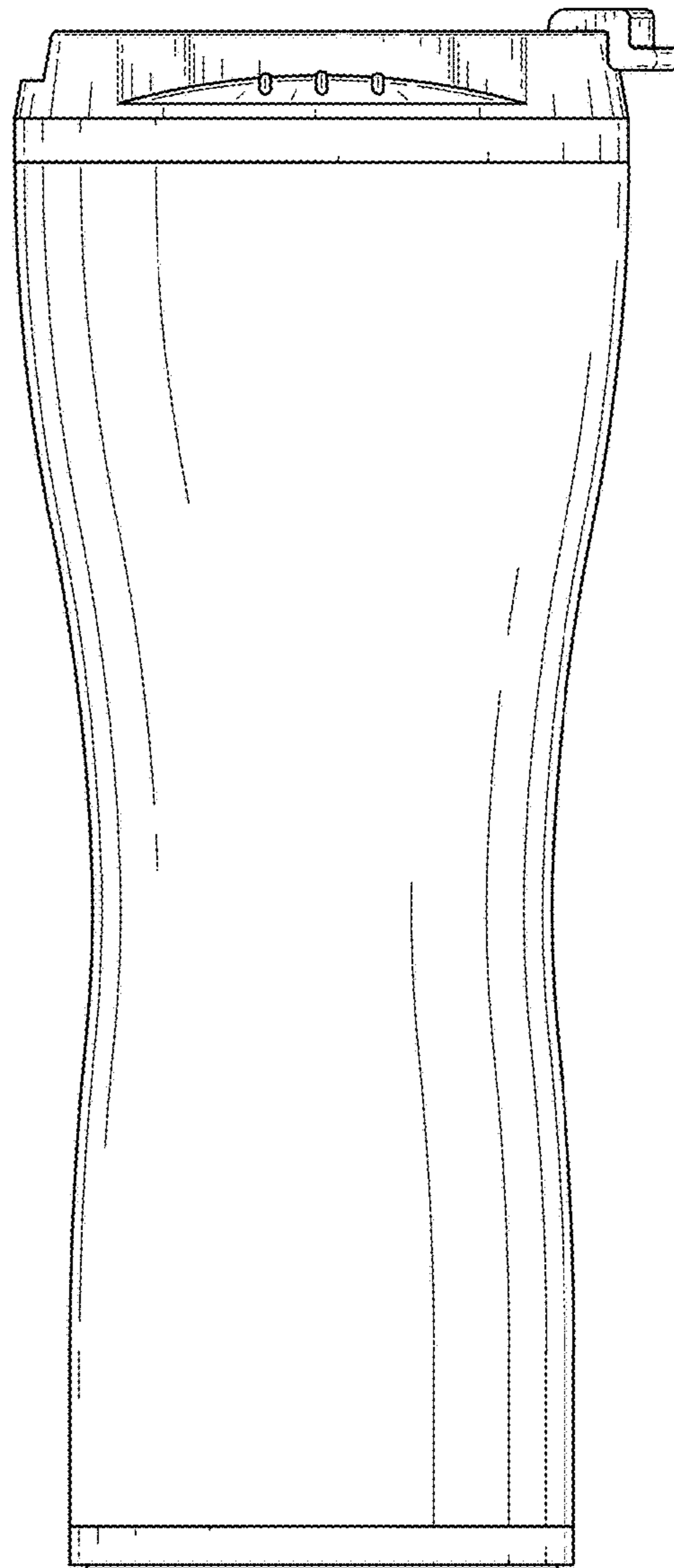

FIG. 7

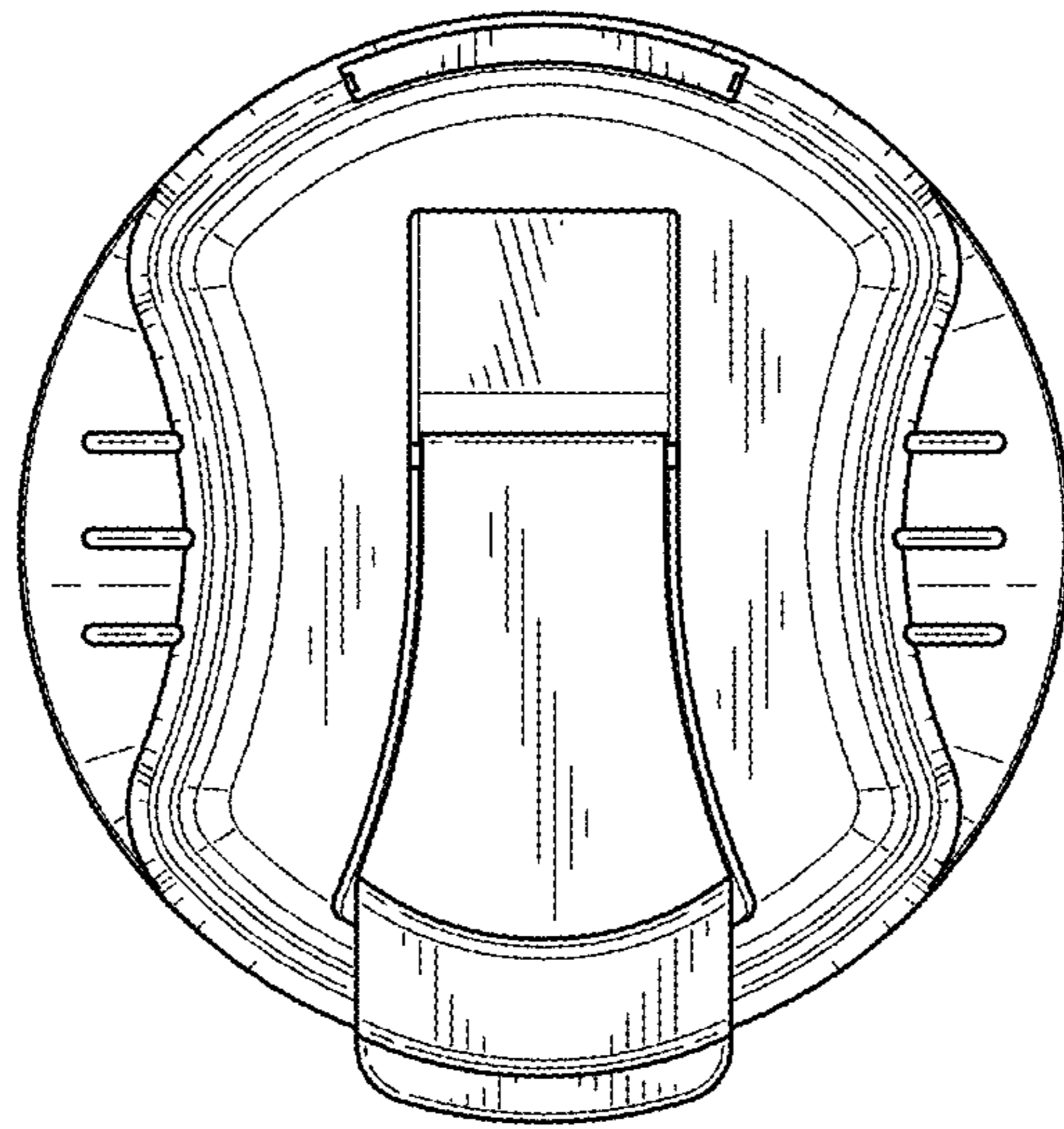

FIG. 8

