



US00D772587S

(12) **United States Design Patent**  
**Micol**

(10) **Patent No.:** **US D772,587 S**

(45) **Date of Patent:** **\*\* Nov. 29, 2016**

(54) **FOLDABLE INFANT CHAIR**

(71) Applicant: **Shayna Micol**, Chelmsford, MA (US)

(72) Inventor: **Shayna Micol**, Chelmsford, MA (US)

(\*\*) Term: **15 Years**

(21) Appl. No.: **29/537,672**

(22) Filed: **Aug. 27, 2015**

(51) **LOC (10) Cl.** ..... **06-01**

(52) **U.S. Cl.**

USPC ..... **D6/333**

(58) **Field of Classification Search**

USPC ..... D6/333-335, 344, 339, 702, 716,  
D6/716.1-716.7; 4/572.1, 571.1, 578.1,  
4/586, 590; 297/183.1-183.4, 184.13,  
297/184.17, 256.1, 467, 487, 488, 445.1;  
D21/419, 412; 5/94, 98.2, 103-104,  
5/93.1, 99.1, 101, 98.1, 12.1;  
D12/129-130; 280/30-31

CPC ..... A47C 3/029; A47C 3/025; A47C 3/021;  
A47C 3/0252

See application file for complete search history.

(56) **References Cited**

**U.S. PATENT DOCUMENTS**

D281,553 S *	12/1985	Glawe .....	D6/333
D282,791 S *	3/1986	Lockett, III .....	D6/333
D321,599 S *	11/1991	Takahashi .....	D6/333
D337,894 S *	8/1993	Mariol .....	D6/333
5,360,258 A	11/1994	Alivizatos	
5,806,925 A	9/1998	Hanley	

D440,412 S *	4/2001	Huang .....	D6/333
D447,879 S *	9/2001	Hsia .....	D6/333
6,428,098 B1	8/2002	Allbaugh	
D478,220 S *	8/2003	Chang .....	D6/333
D560,374 S *	1/2008	Bergkvist .....	D6/333
7,320,223 B1	1/2008	Dabney et al.	
7,444,695 B2	11/2008	Gonzalez	
7,806,472 B2	10/2010	Runk et al.	
D648,144 S *	11/2011	Oren .....	D6/344
8,468,629 B2	6/2013	Beevers et al.	
D720,938 S *	1/2015	Gerspach .....	D6/348
D737,584 S *	9/2015	Marcuello .....	D6/333
D751,305 S *	3/2016	Robbins .....	D6/333

\* cited by examiner

*Primary Examiner* — Abraham Bahta

(74) *Attorney, Agent, or Firm* — Robert S. Blasi, Esq.;  
Danielson Legal LLC

(57) **CLAIM**

The ornamental design for a foldable infant chair, substantially as shown and described.

**DESCRIPTION**

FIG. 1 is a perspective view of the foldable infant chair showing my new design;  
FIG. 2 is a left side view thereof;  
FIG. 3 is a right side view thereof;  
FIG. 4 is a front view thereof;  
FIG. 5 is a back view thereof;  
FIG. 6 is a top view thereof;  
FIG. 7 is a bottom view thereof; and,  
FIG. 8 is a side view thereof; the foldable infant chair shown in a folded configuration.

**1 Claim, 5 Drawing Sheets**

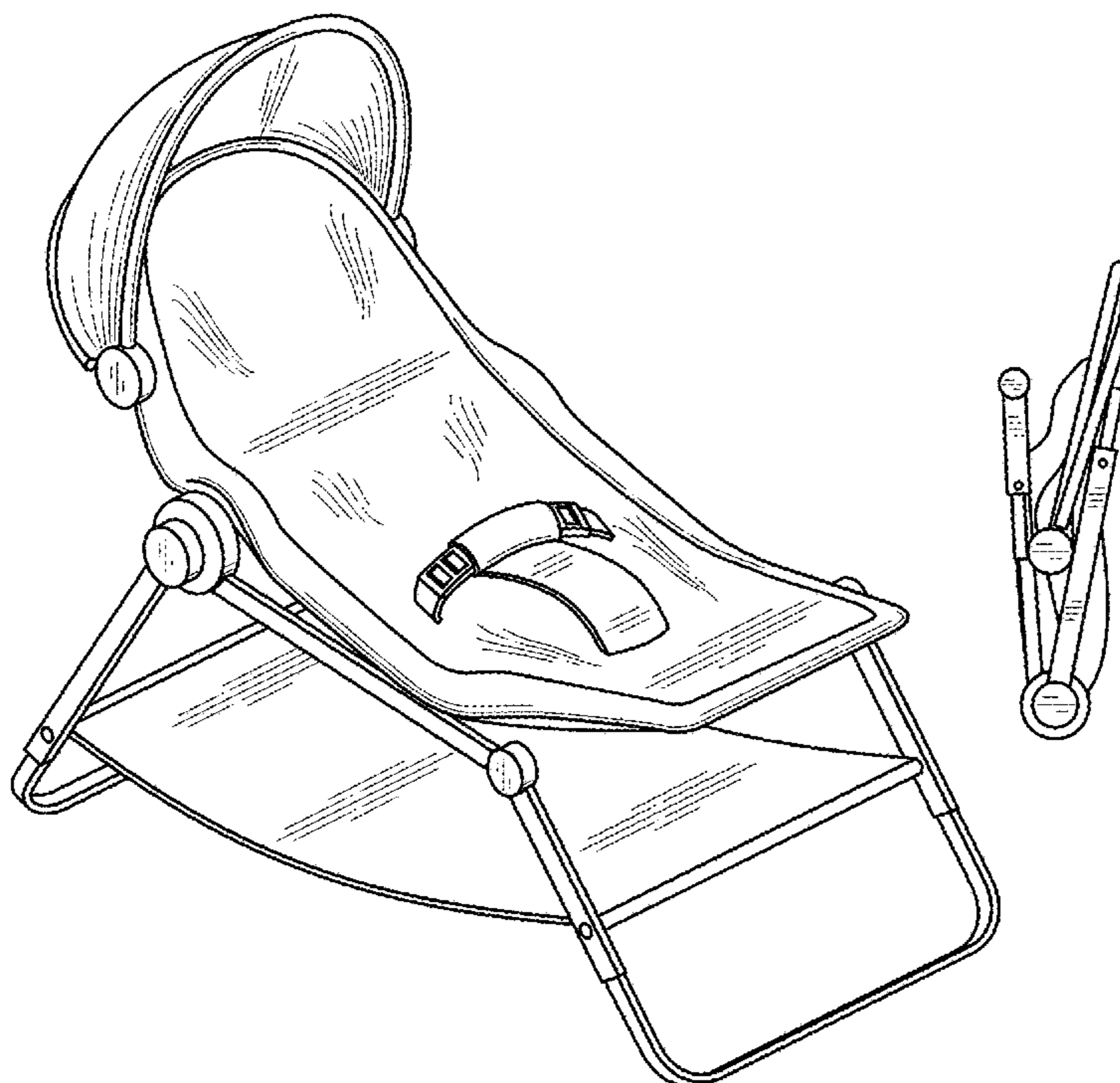

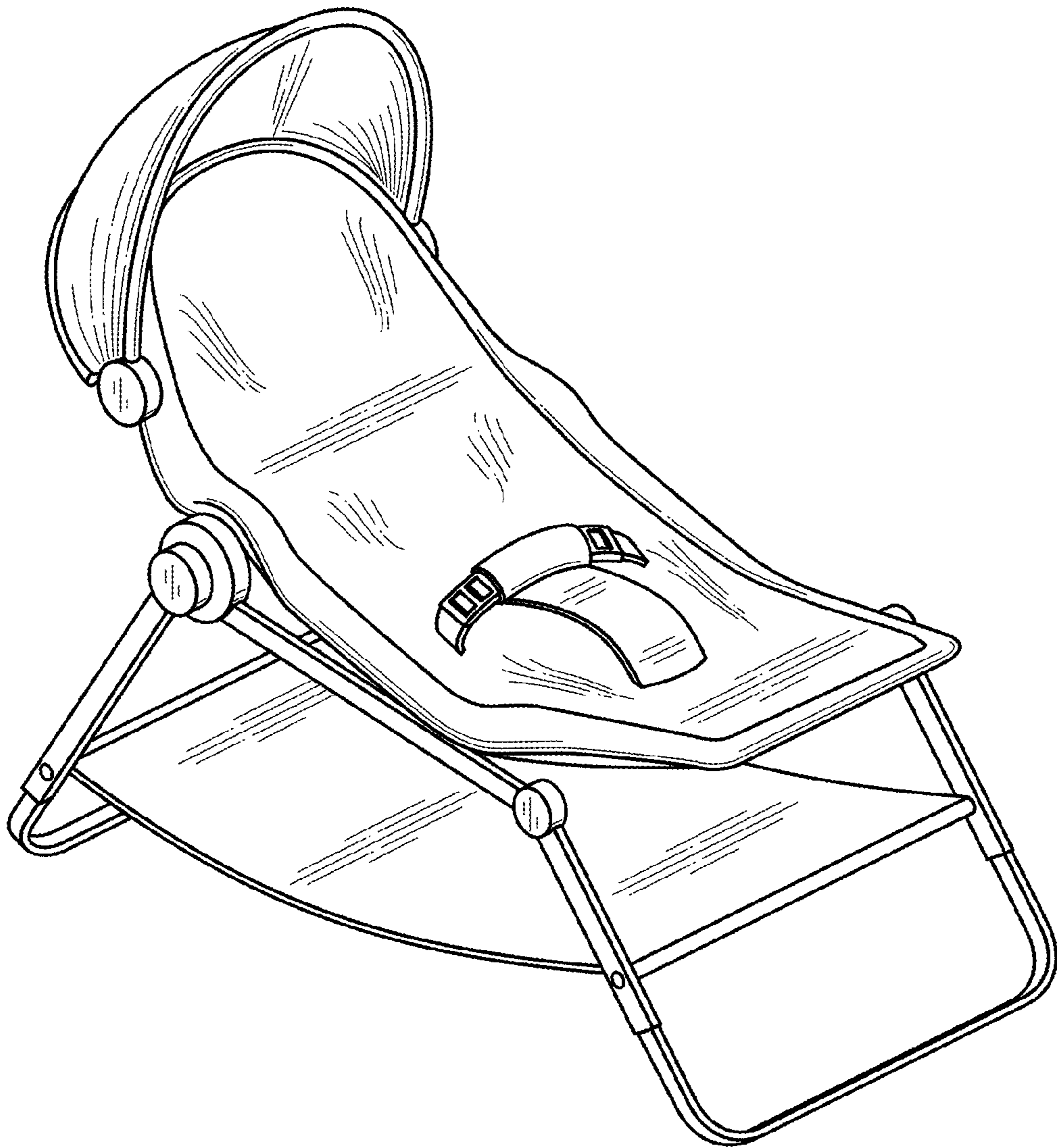

FIG. 1

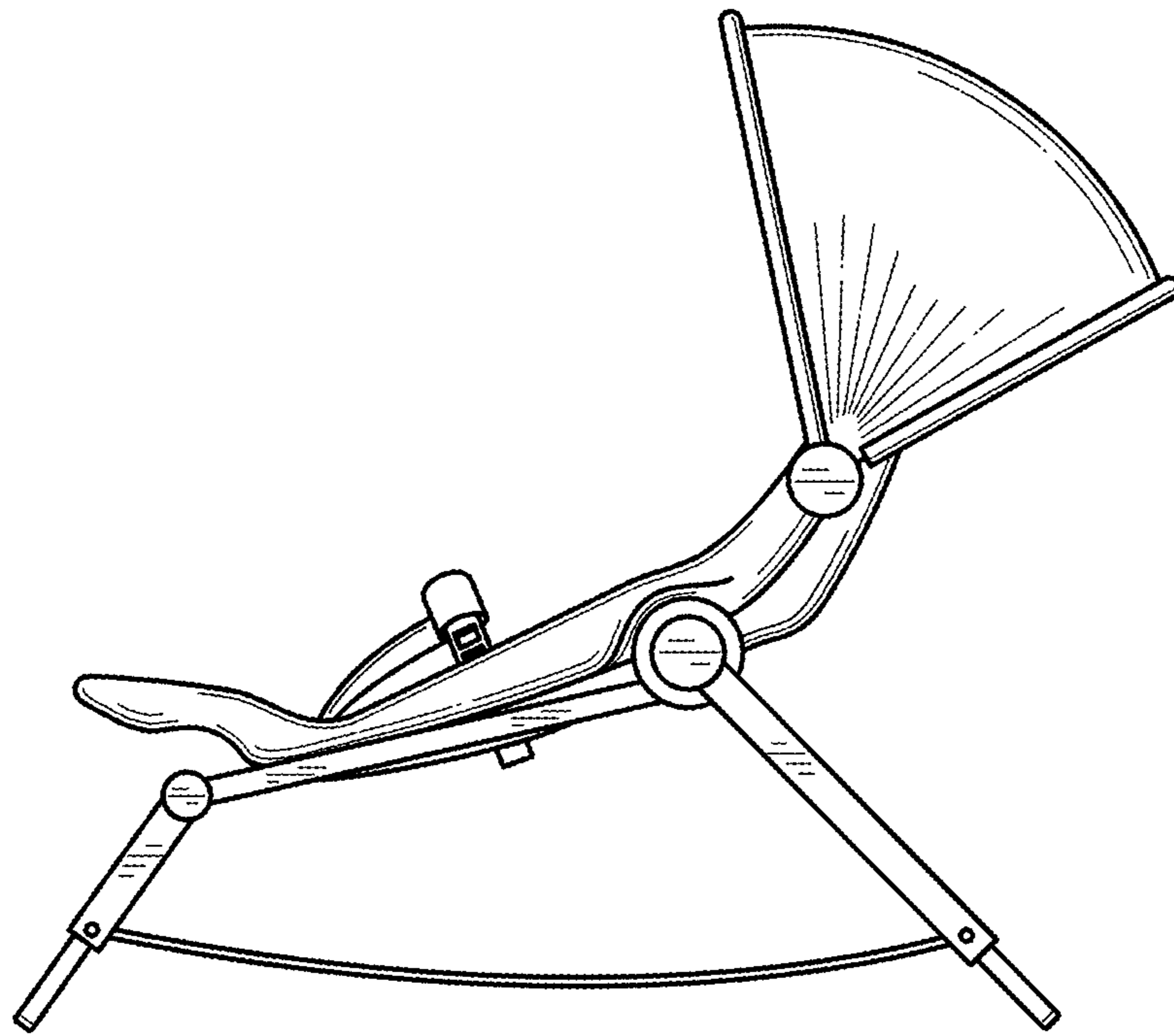

FIG. 2

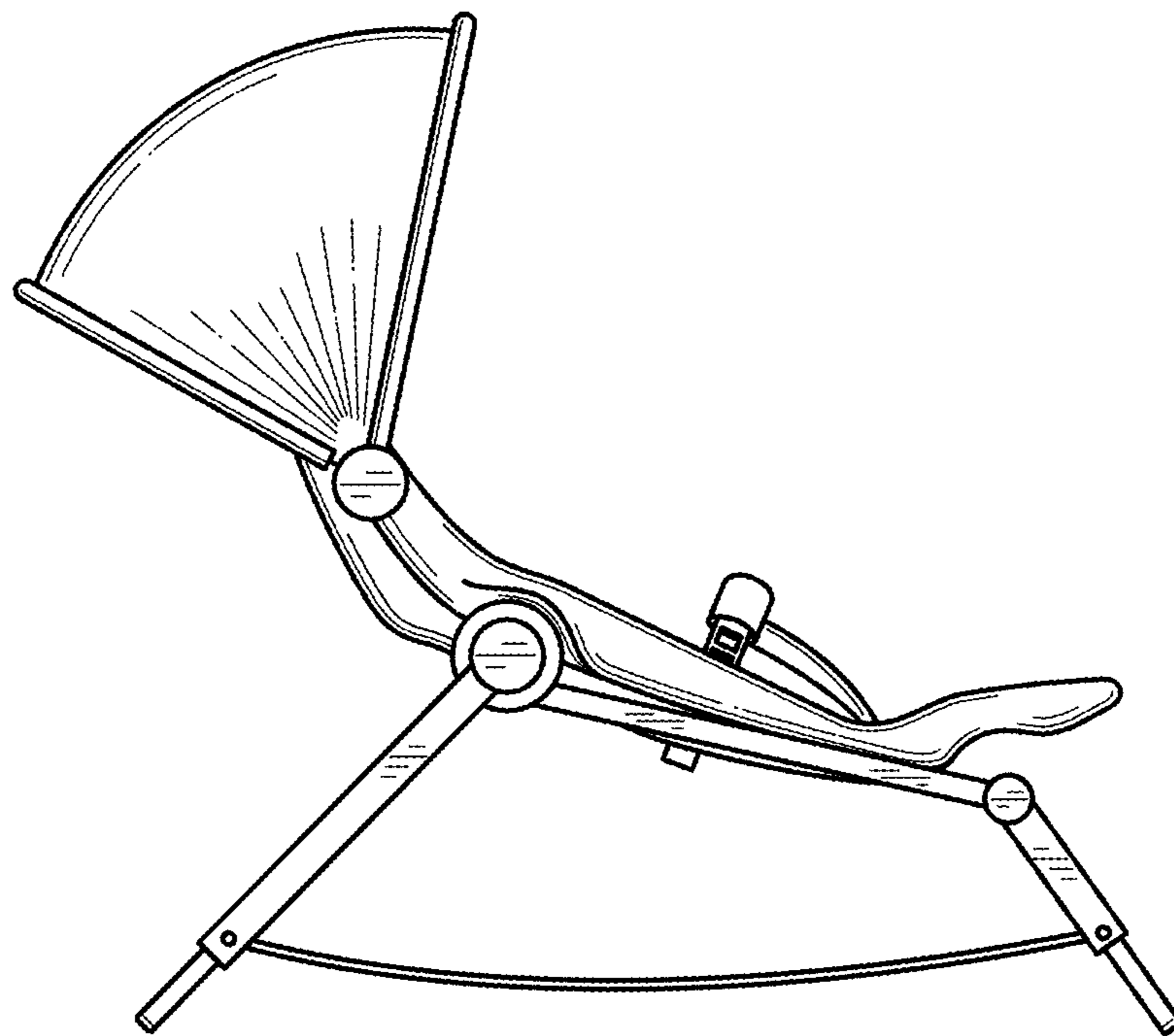

FIG. 3

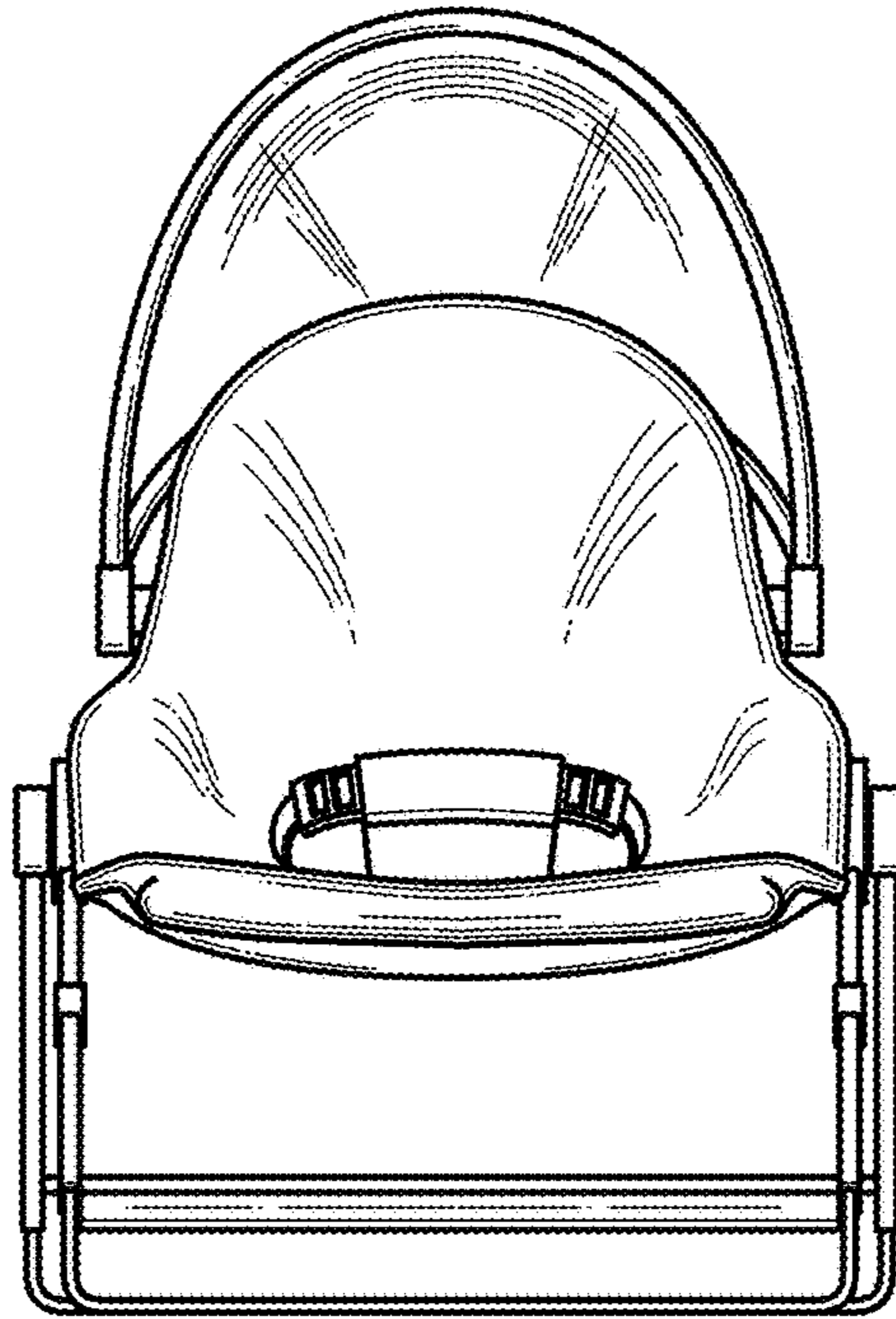

FIG. 4

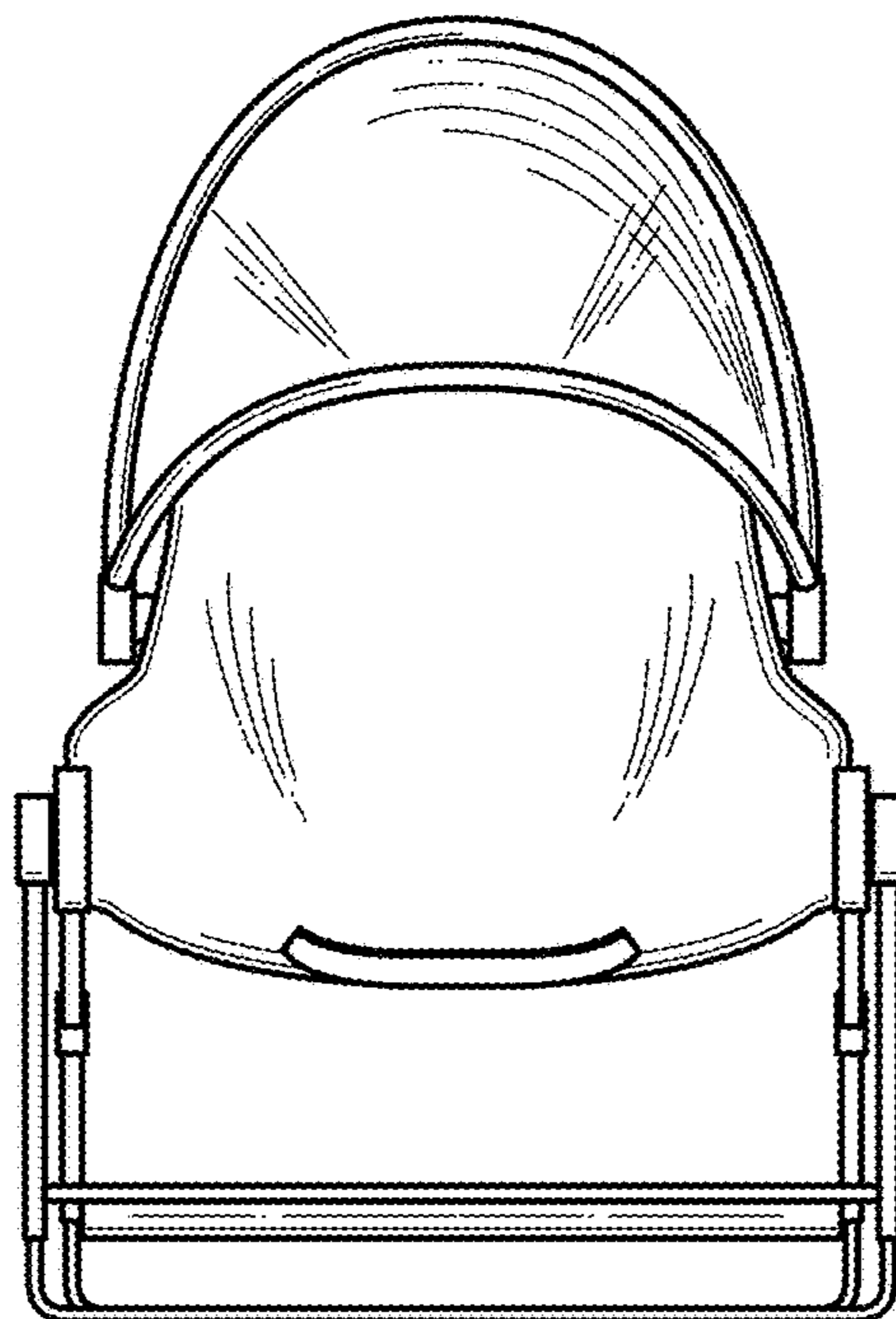

FIG. 5

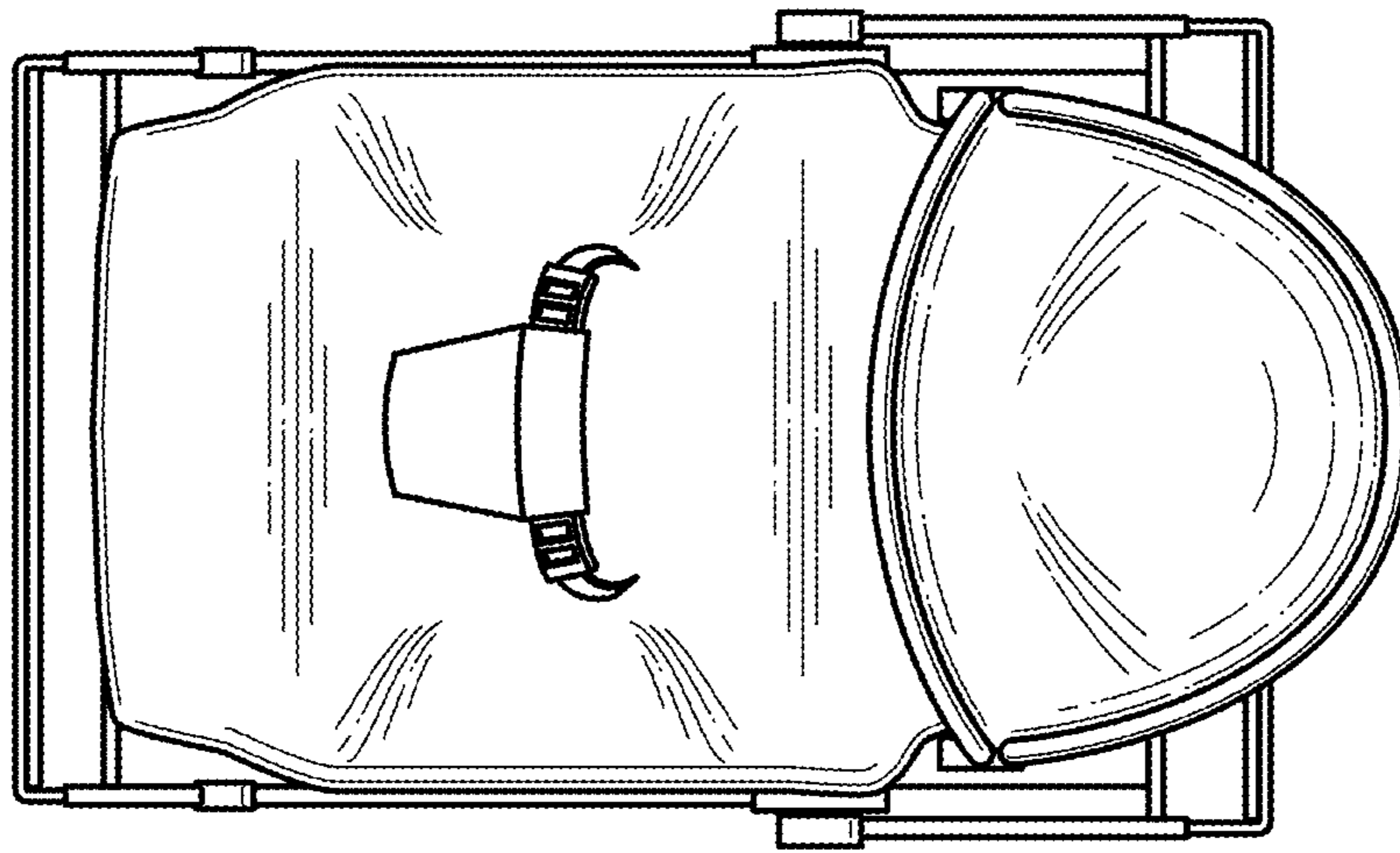

FIG. 6

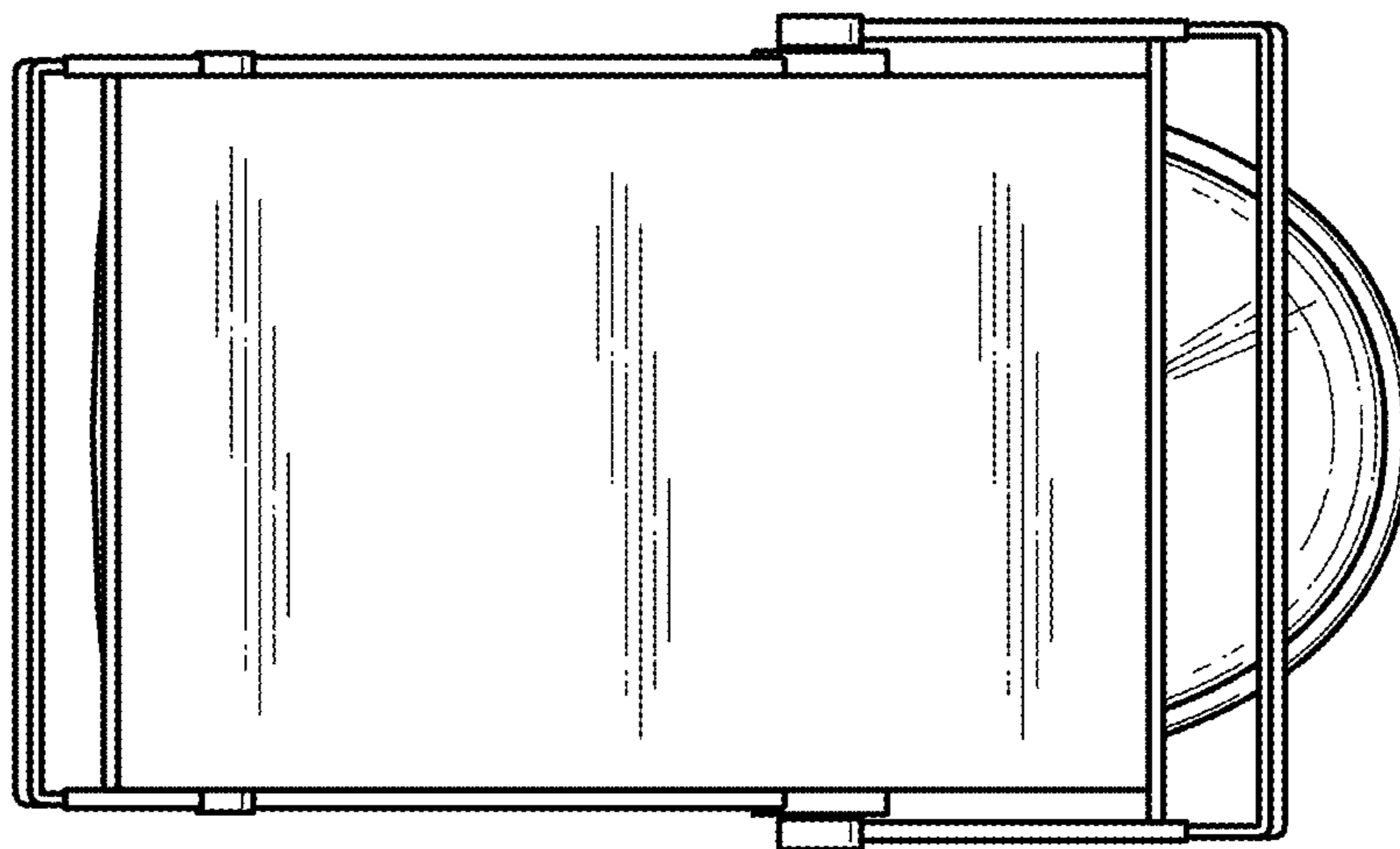

FIG. 7

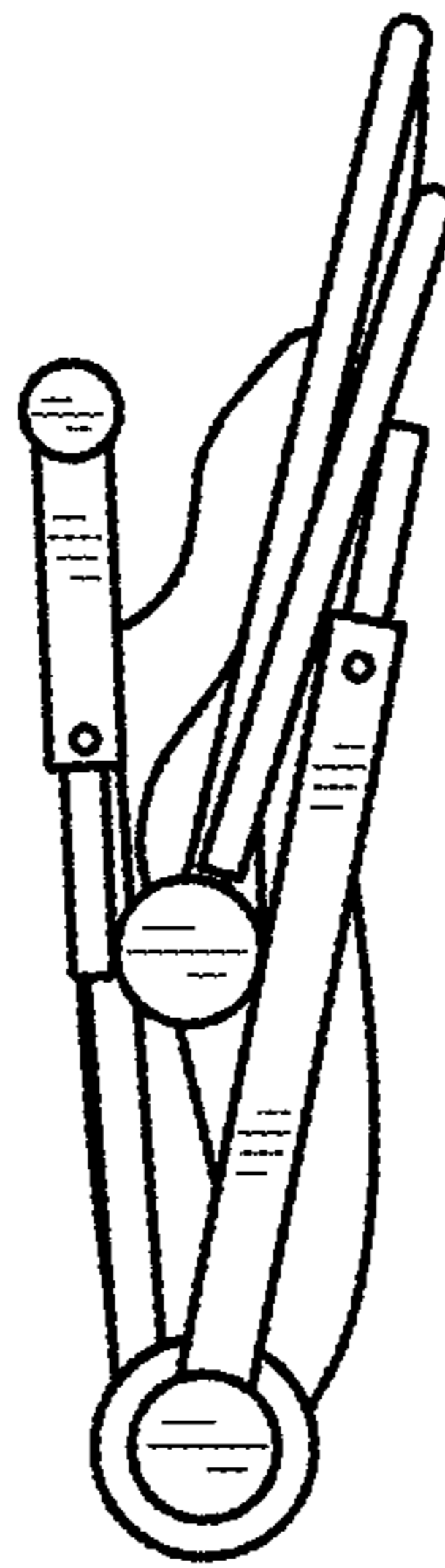

FIG. 8