



US00D772566S

(12) **United States Design Patent** (10) **Patent No.:** **US D772,566 S**  
**Slimane** (45) **Date of Patent:** **\*\* Nov. 29, 2016**

(54) **HANDBAG**  
(71) Applicant: **YVES SAINT LAURENT**, Paris (FR)  
(72) Inventor: **Hedi Slimane**, City of West Hollywood, CA (US)  
(73) Assignee: **YVES SAINT LAURENT**, Paris (FR)  
(\*\*) Term: **15 Years**

(21) Appl. No.: **29/532,306**  
(22) Filed: **Jul. 6, 2015**  
(51) **LOC (10) Cl.** ..... **03-01**  
(52) **U.S. Cl.**  
USPC ..... **D3/245**  
(58) **Field of Classification Search**  
USPC ..... D3/232-233, 240-243, 245-246  
CPC ..... A45C 1/024; A45C 3/06  
See application file for complete search history.

(56) **References Cited**  
**U.S. PATENT DOCUMENTS**  
2,875,802 A \* 3/1959 Koret ..... A45C 3/06  
150/112  
D649,780 S \* 12/2011 Fendi ..... D3/245

D728,227 S \* 5/2015 Hawkes ..... D3/245  
\* cited by examiner  
*Primary Examiner* — Holly Baynham  
(74) *Attorney, Agent, or Firm* — Donald J. Ranft; Collen IP

(57) **CLAIM**  
The ornamental design for a handbag, as shown and described.

**DESCRIPTION**

FIG. 1 is a front right perspective view of a handbag showing my new design;  
FIG. 2 is a rear bottom left perspective view thereof;  
FIG. 3 is a top view thereof;  
FIG. 4 is a bottom view thereof;  
FIG. 5 is a left side view with snaps closed thereof;  
FIG. 6 is a right side view with snaps open thereof;  
FIG. 7 is a front view thereof;  
FIG. 8 is a rear view thereof; and,  
FIG. 9 is a top perspective unzipped/unsnapped interior view thereof.  
The portions of the handbag shown in dashed lines represent stitches and is part of the claimed design.

**1 Claim, 8 Drawing Sheets**

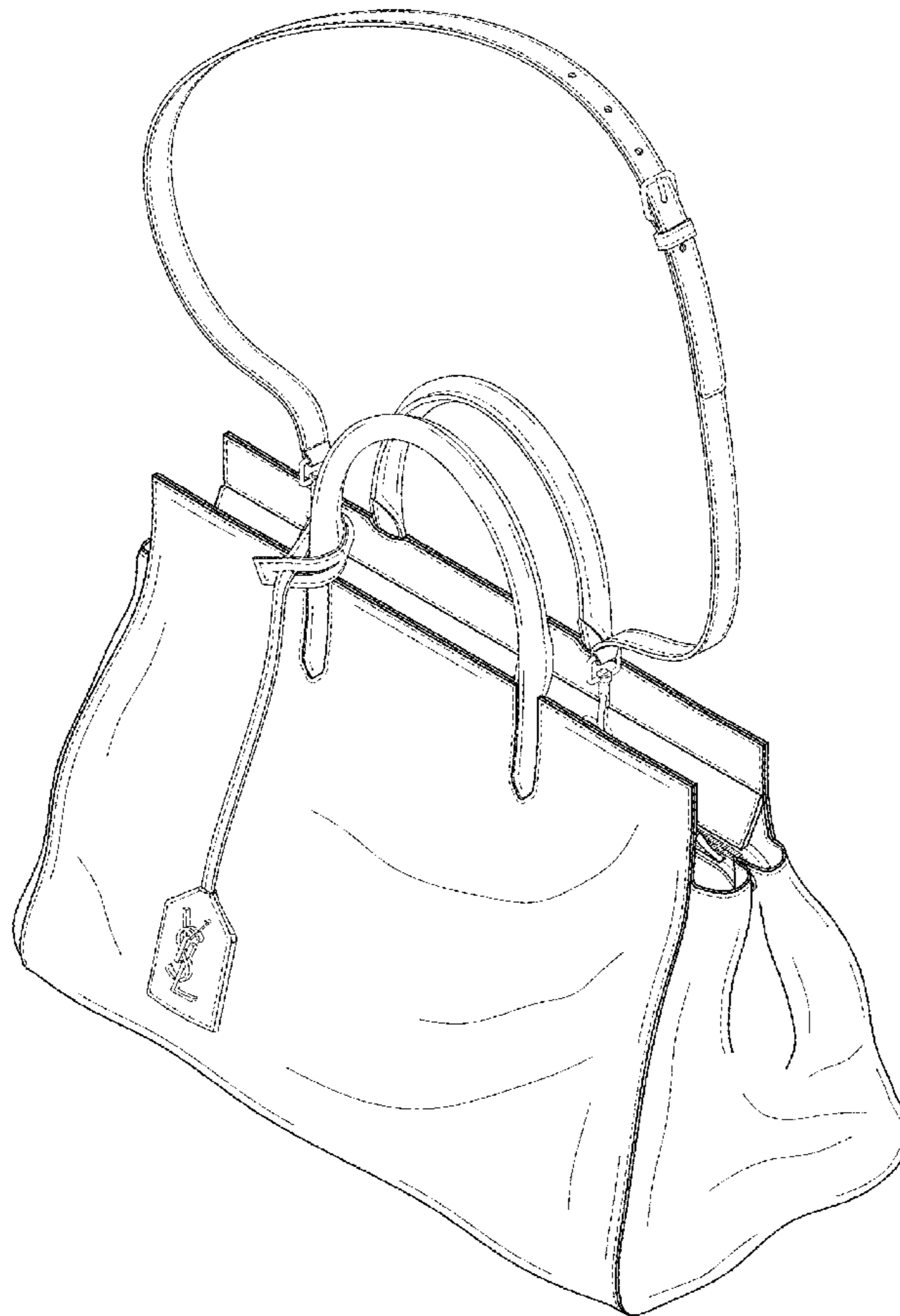



FIG. 1

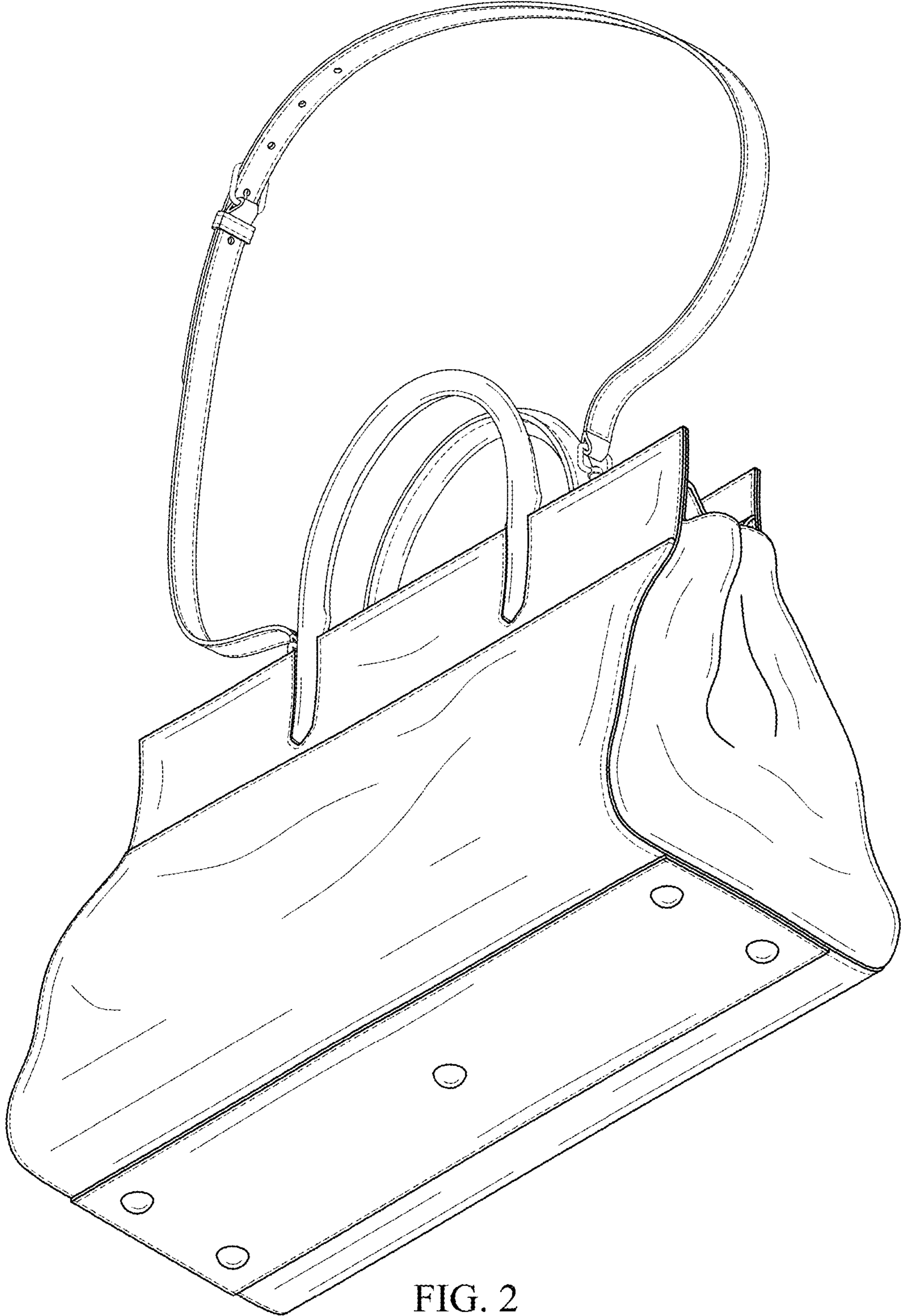

FIG. 2

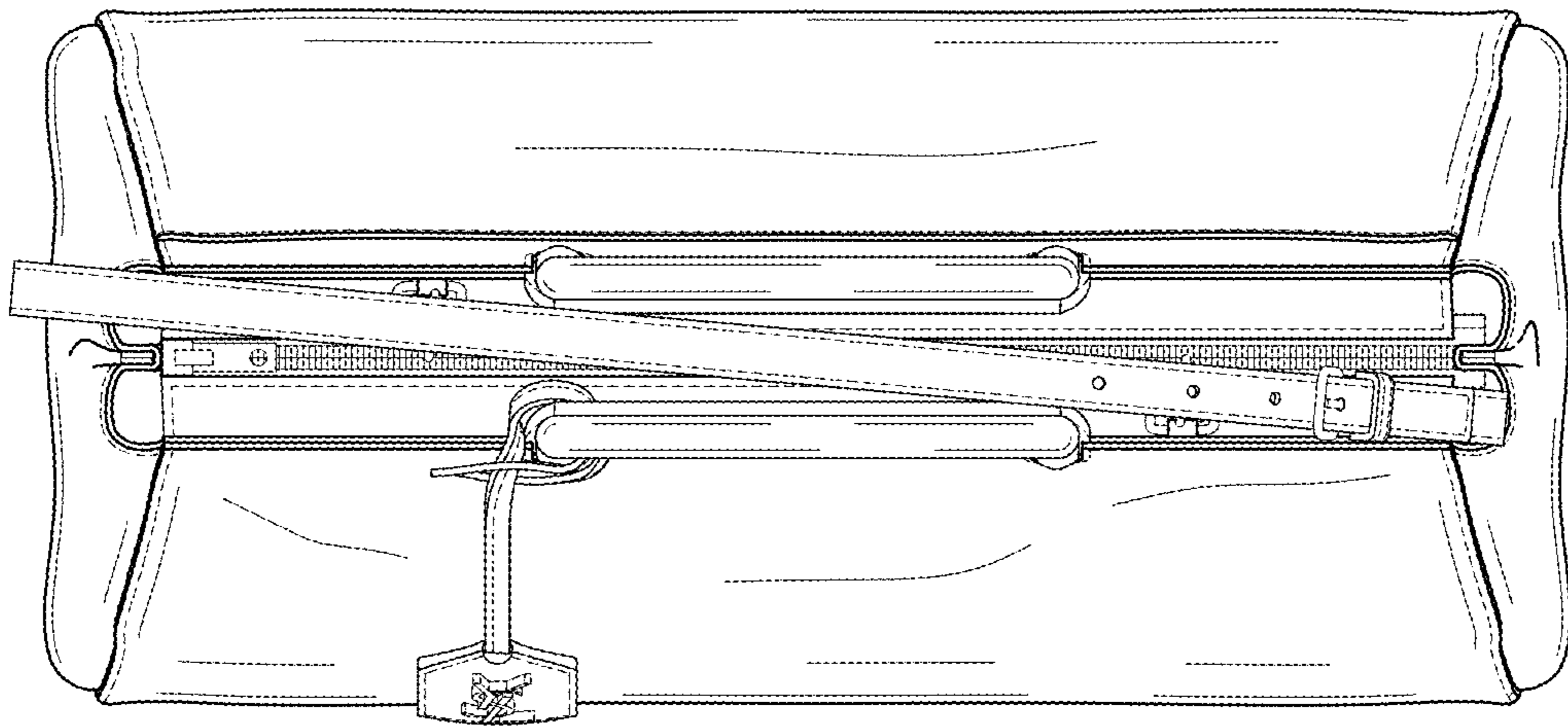

FIG. 3

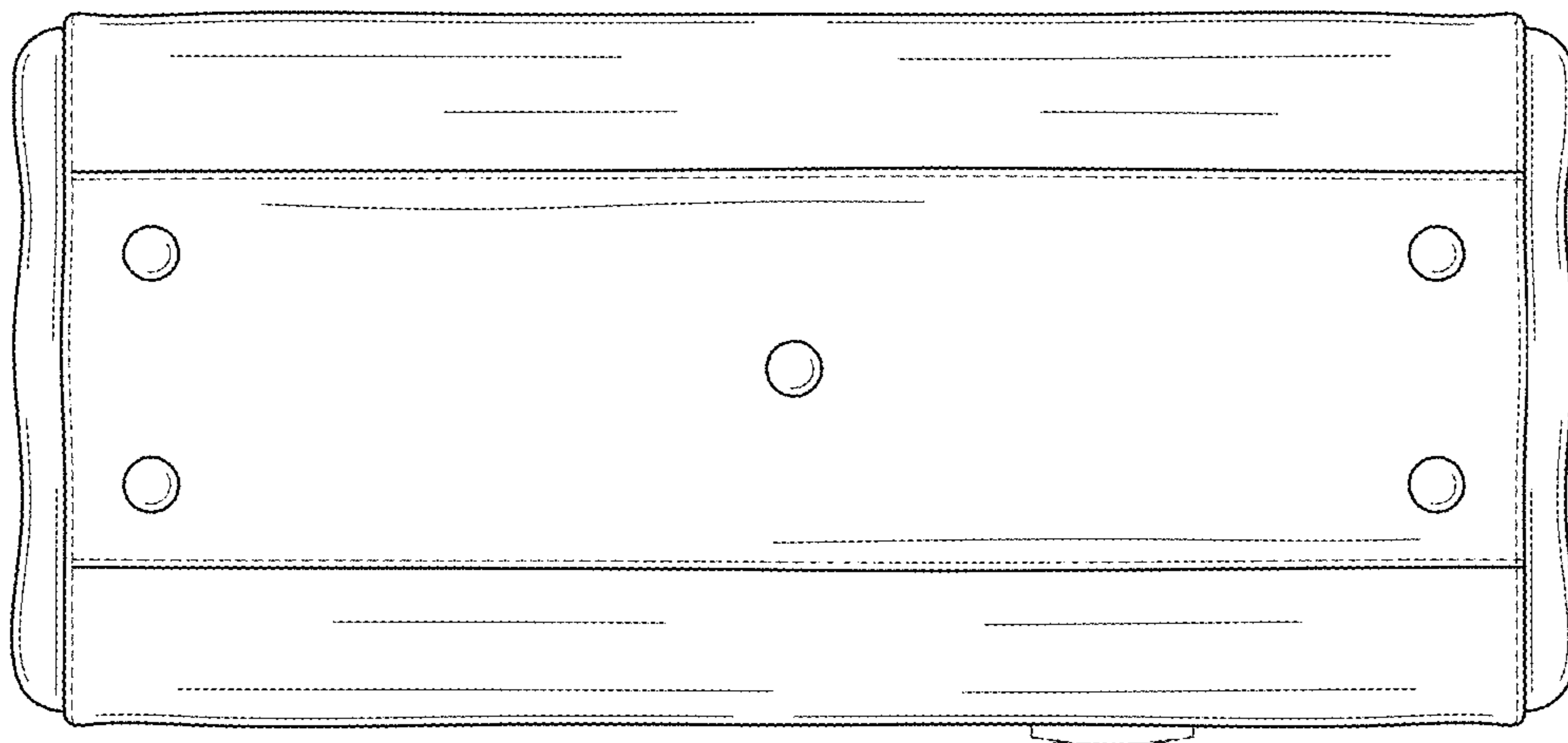

FIG. 4

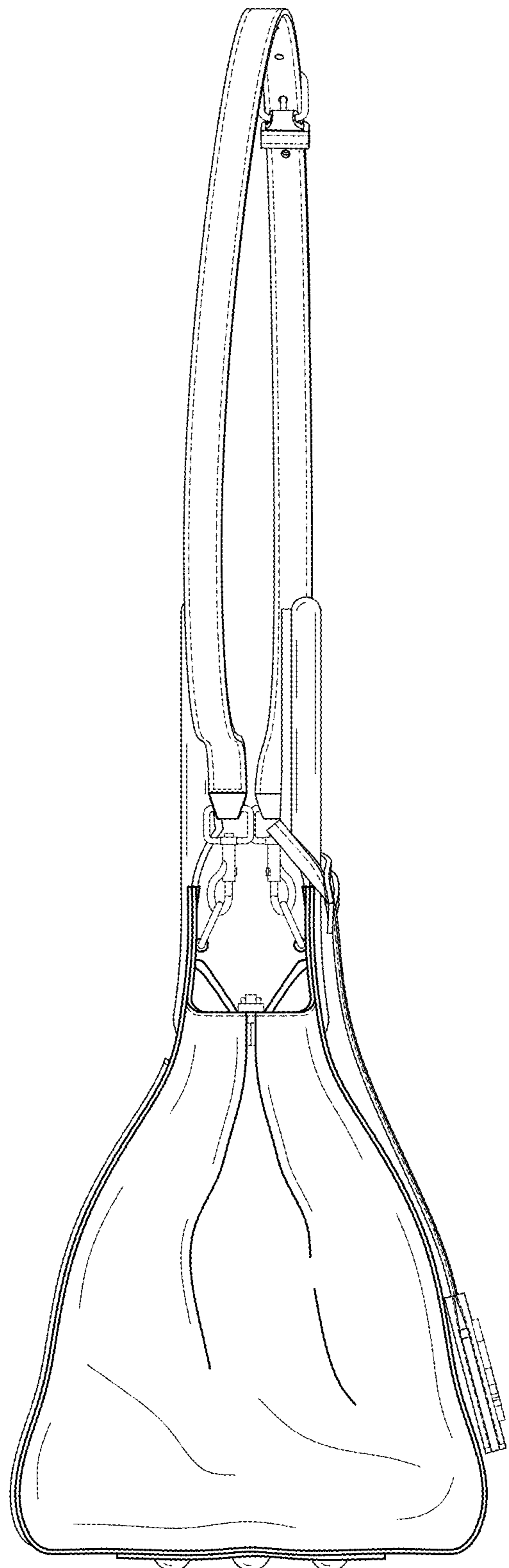

FIG. 5

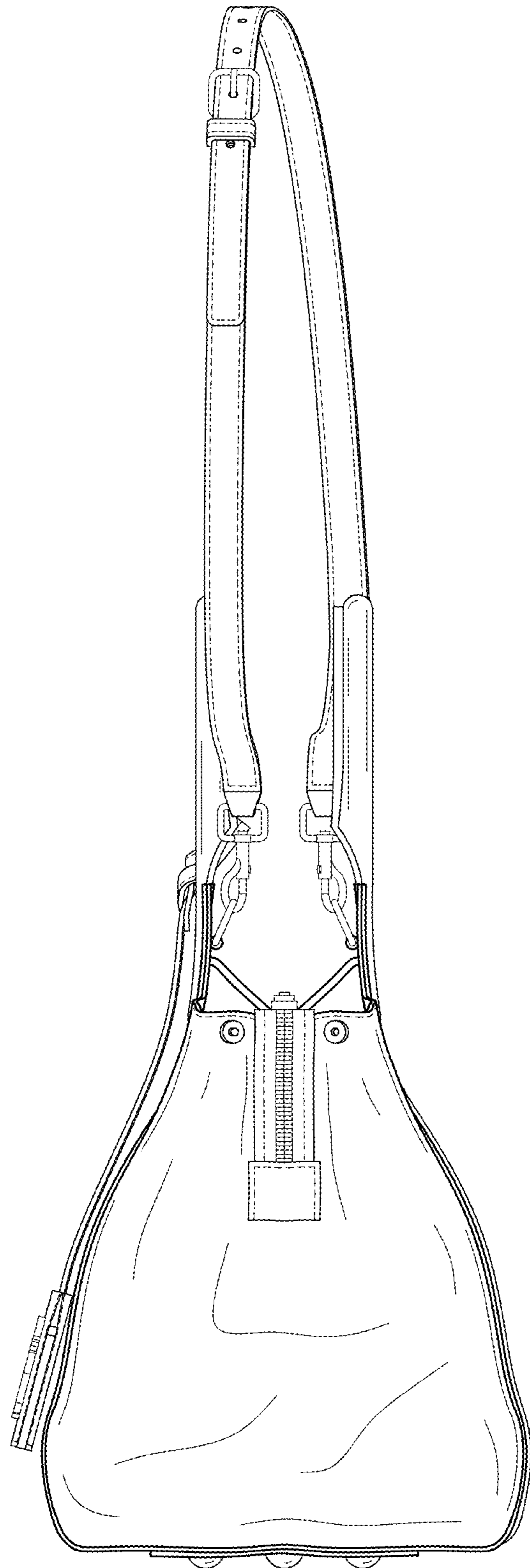

FIG. 6

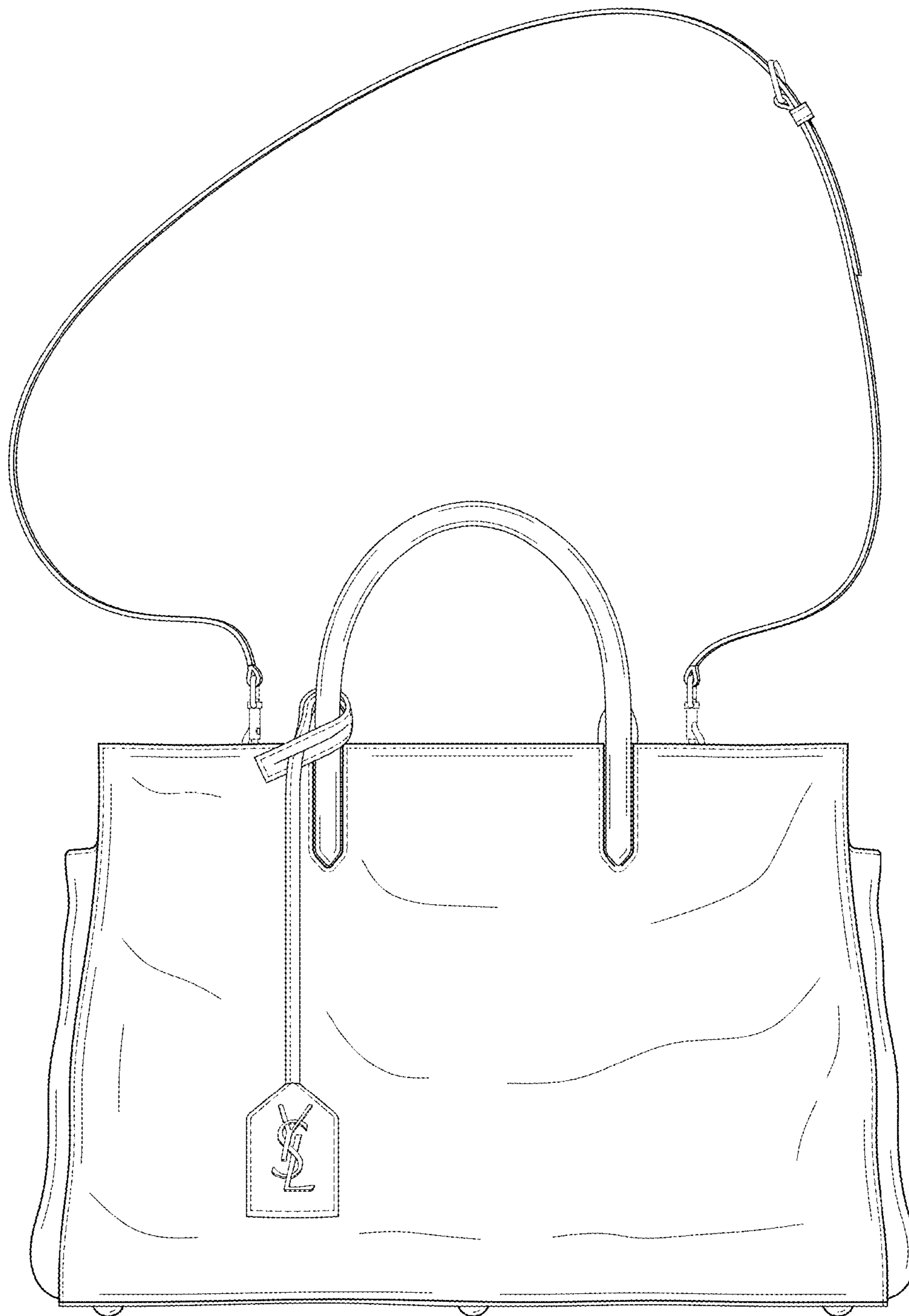

FIG. 7

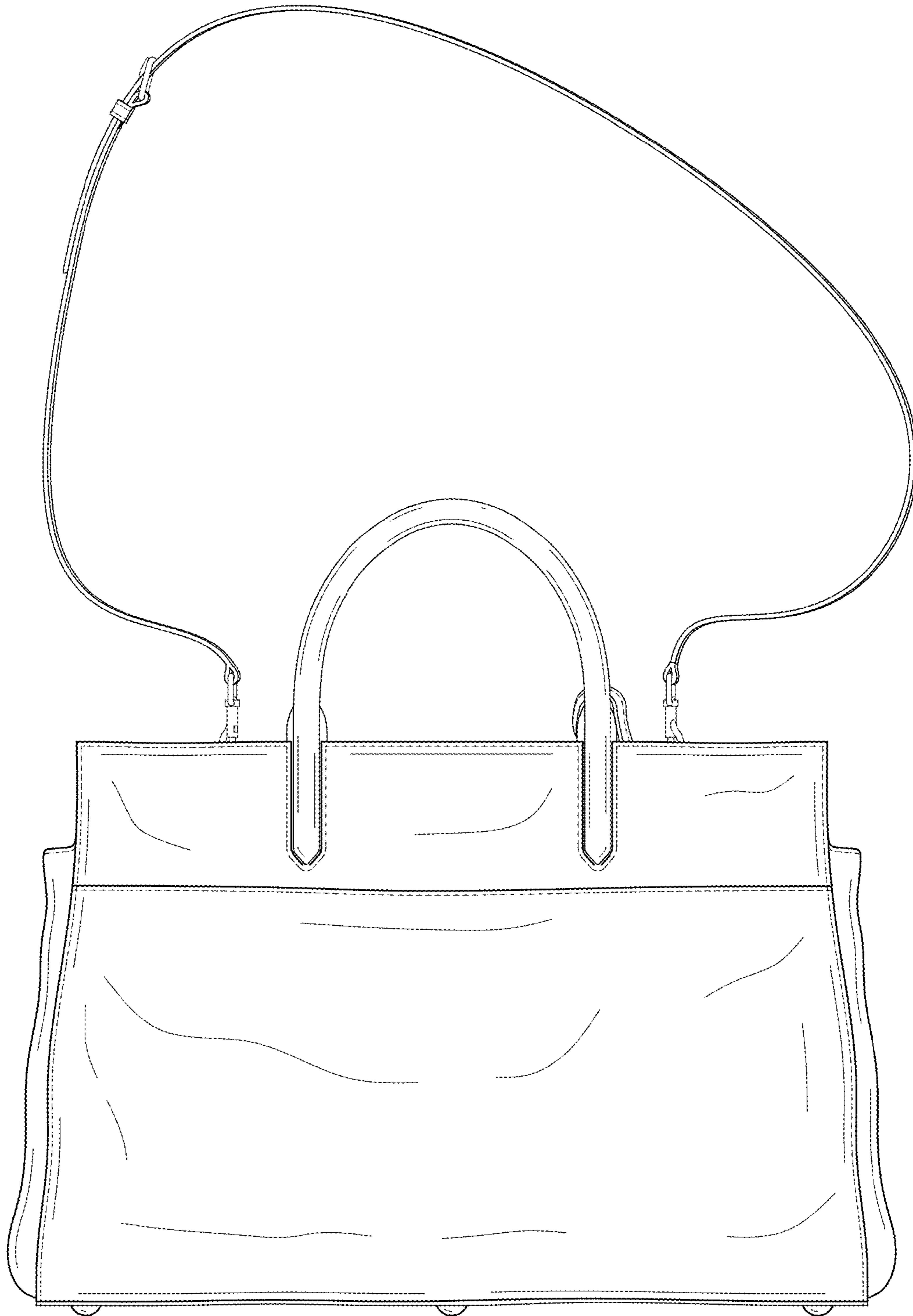

FIG. 8



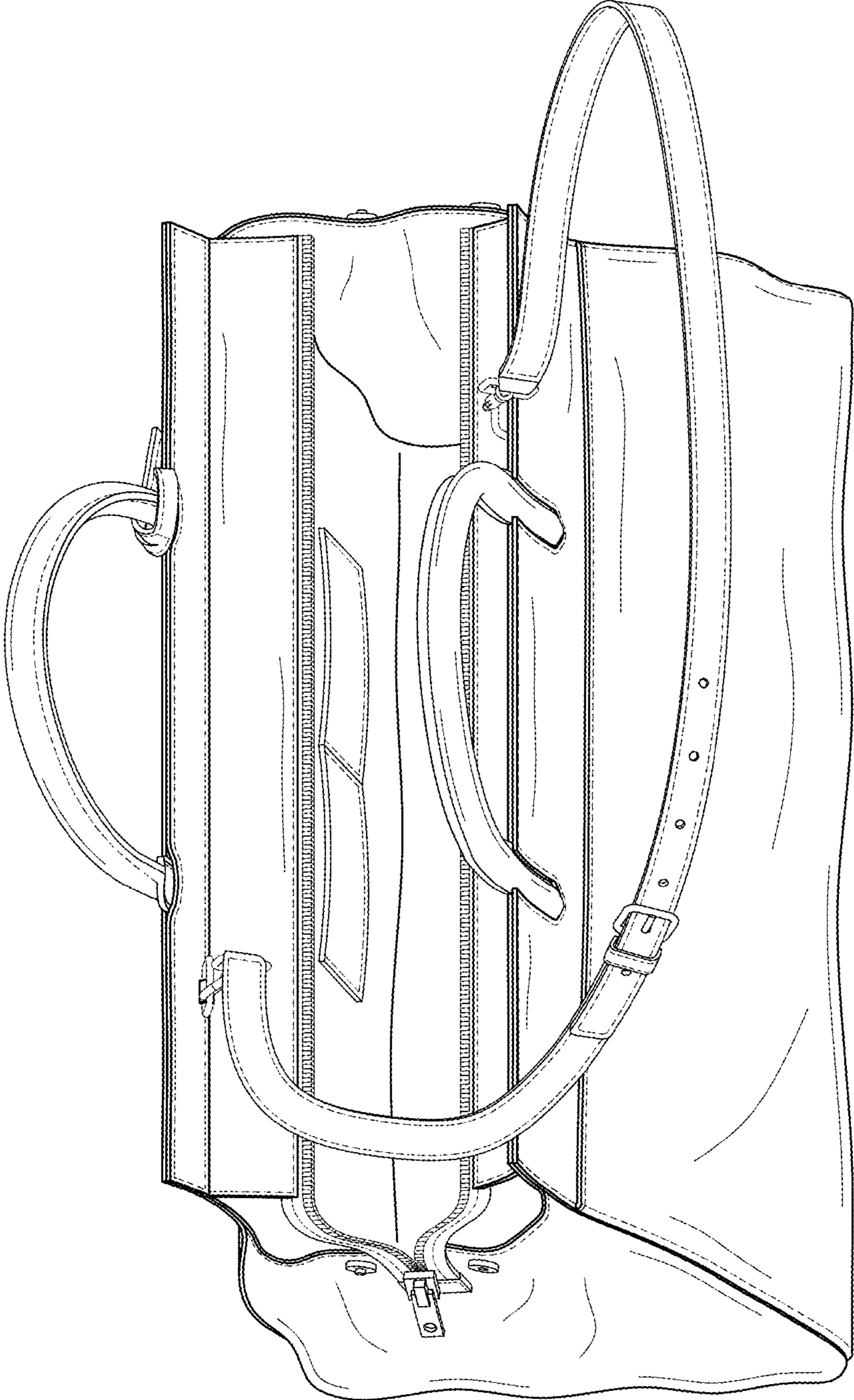

FIG. 9