



US00D772565S

(12) **United States Design Patent** (10) **Patent No.:** **US D772,565 S**
Gavriel et al. (45) **Date of Patent:** **** Nov. 29, 2016**

(54) **HANDBAG**
 (71) Applicant: **Mansur Gavriel LLC**, New York, NY (US)
 (72) Inventors: **Floriana Gavriel**, New York, NY (US); **Rachel Mansur**, New York, NY (US)
 (73) Assignee: **Mansur Gavriel LLC**, New York, NY (US)

D610,801 S * 3/2010 Romero D3/232
 D666,809 S * 9/2012 Hermann D3/232
 D747,874 S 1/2016 Della Valle

FOREIGN PATENT DOCUMENTS

BE	DM047197	3/1999
CA	12823	8/1940
EM	000792262-0002	9/2007
EM	002704338-0002	5/2015
GB	4015340	6/2010

* cited by examiner

Primary Examiner — Holly Baynham

(74) *Attorney, Agent, or Firm* — Kelley Drye & Warren LLP

(**) Term: **15 Years**
 (21) Appl. No.: **29/568,401**

(22) Filed: **Jun. 17, 2016**

(51) **LOC (10) Cl.** **03-01**

(52) **U.S. Cl.**
USPC **D3/243**

(58) **Field of Classification Search**
 USPC D3/232–233, 240–243, 245–246
 CPC A45C 1/024; A45C 3/08
 See application file for complete search history.

(57) **CLAIM**

The ornamental design for a handbag, as shown and described.

DESCRIPTION

FIG. 1 is a perspective view of a handbag;
 FIG. 2 is a front view thereof;
 FIG. 3 is a rear view thereof;
 FIG. 4 is a left side view thereof;
 FIG. 5 is a right side view thereof;
 FIG. 6 is a top view thereof; and,
 FIG. 7 is a bottom view thereof.

The broken lines shown in the figures are included for the purpose of illustrating the environment in which the design is used and form no part of the claimed design.

(56) **References Cited**

U.S. PATENT DOCUMENTS

D38,853 S	*	10/1907	Hauser	D3/240
D111,710 S	*	10/1938	Lewis	D3/240
D129,151 S	*	8/1941	Lewis	D3/240
D131,188 S	*	1/1942	Lewis	D3/240
D143,934 S	*	2/1946	Rath	D3/240
D443,413 S		6/2001	Naiken-Goddin		
D476,809 S	*	7/2003	Ko	D3/232
D523,630 S		6/2006	Handley		
D528,788 S	*	9/2006	Chaillet		

1 Claim, 5 Drawing Sheets

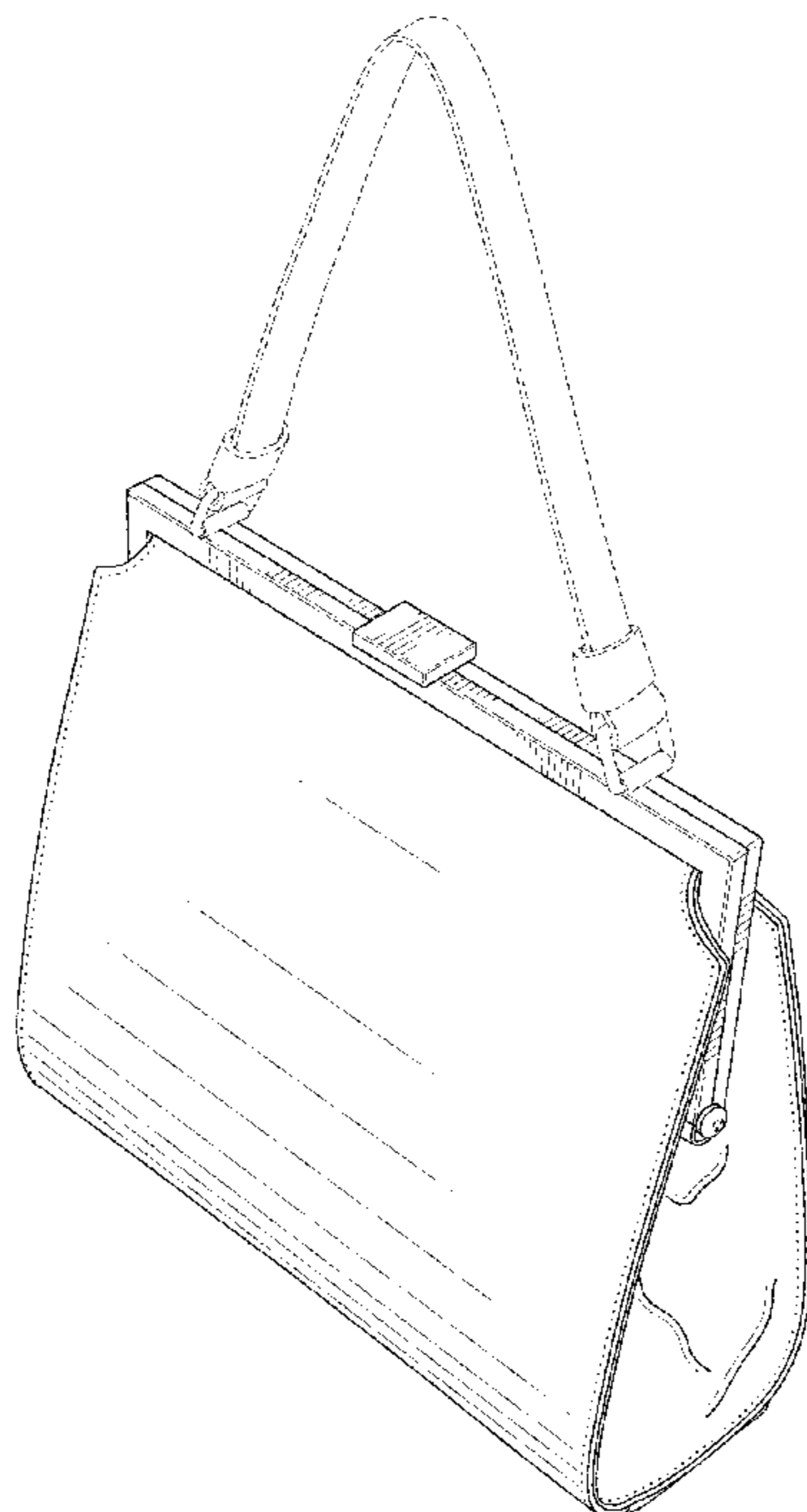

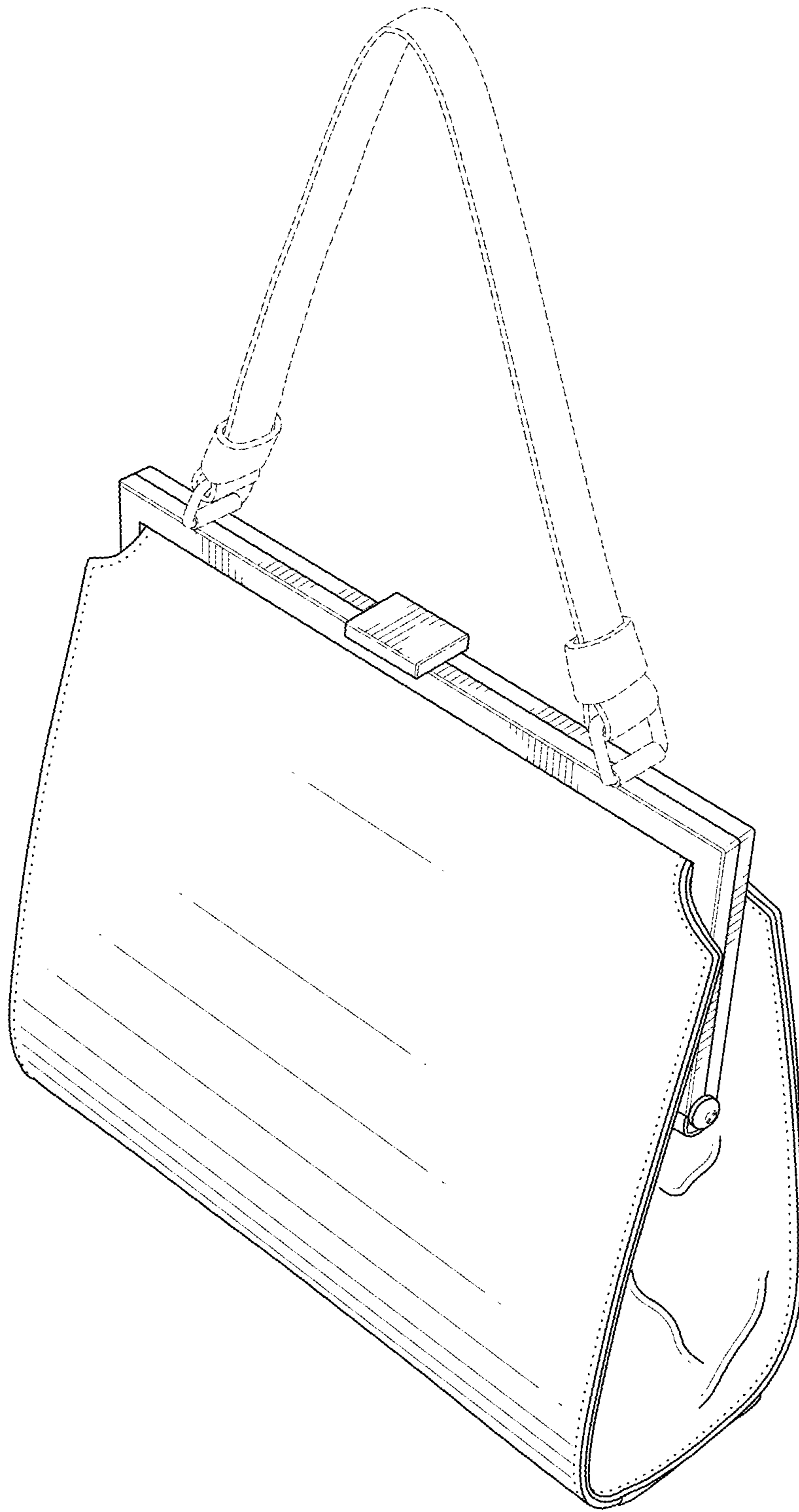

FIG. 1

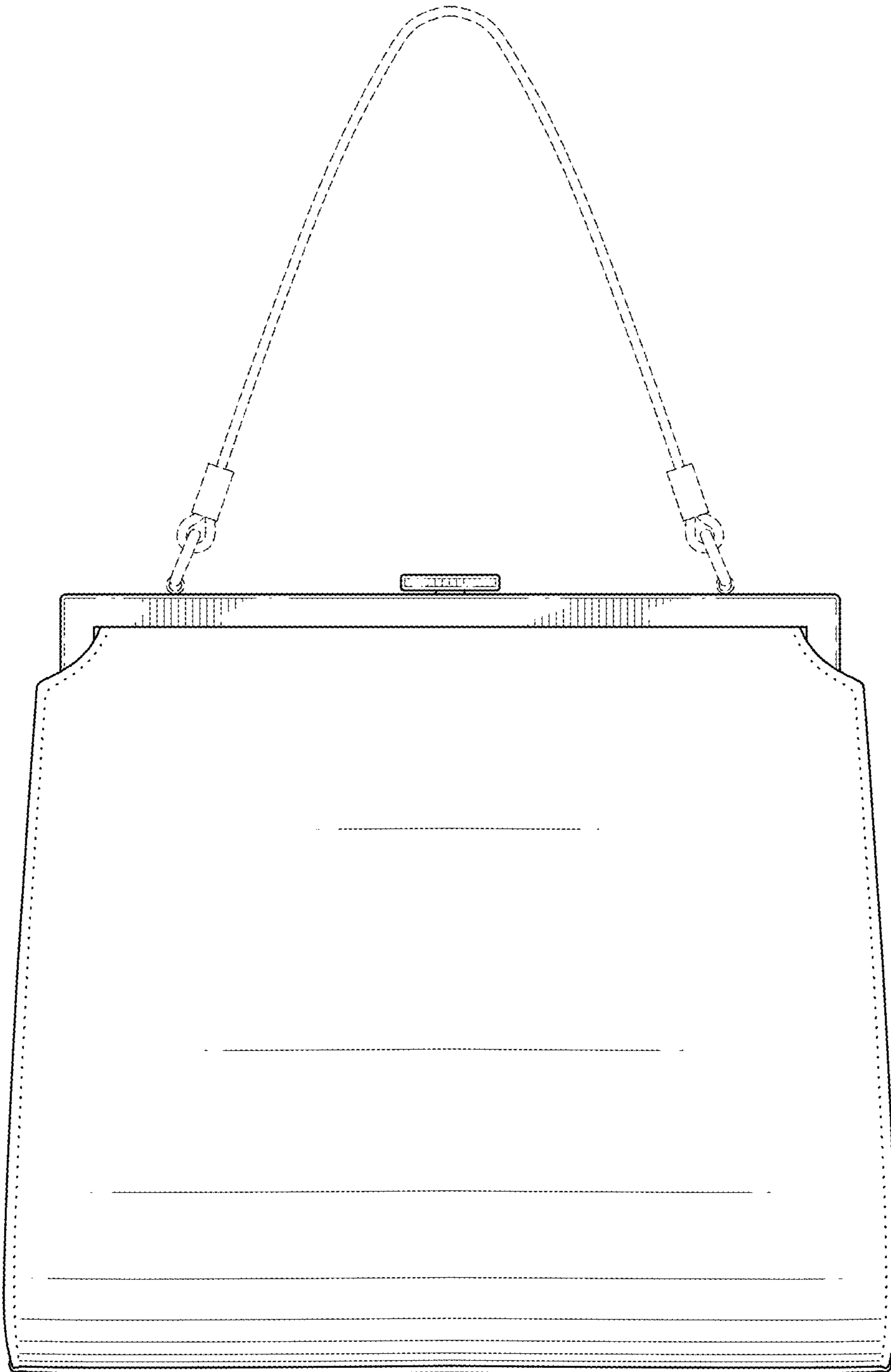

FIG. 2

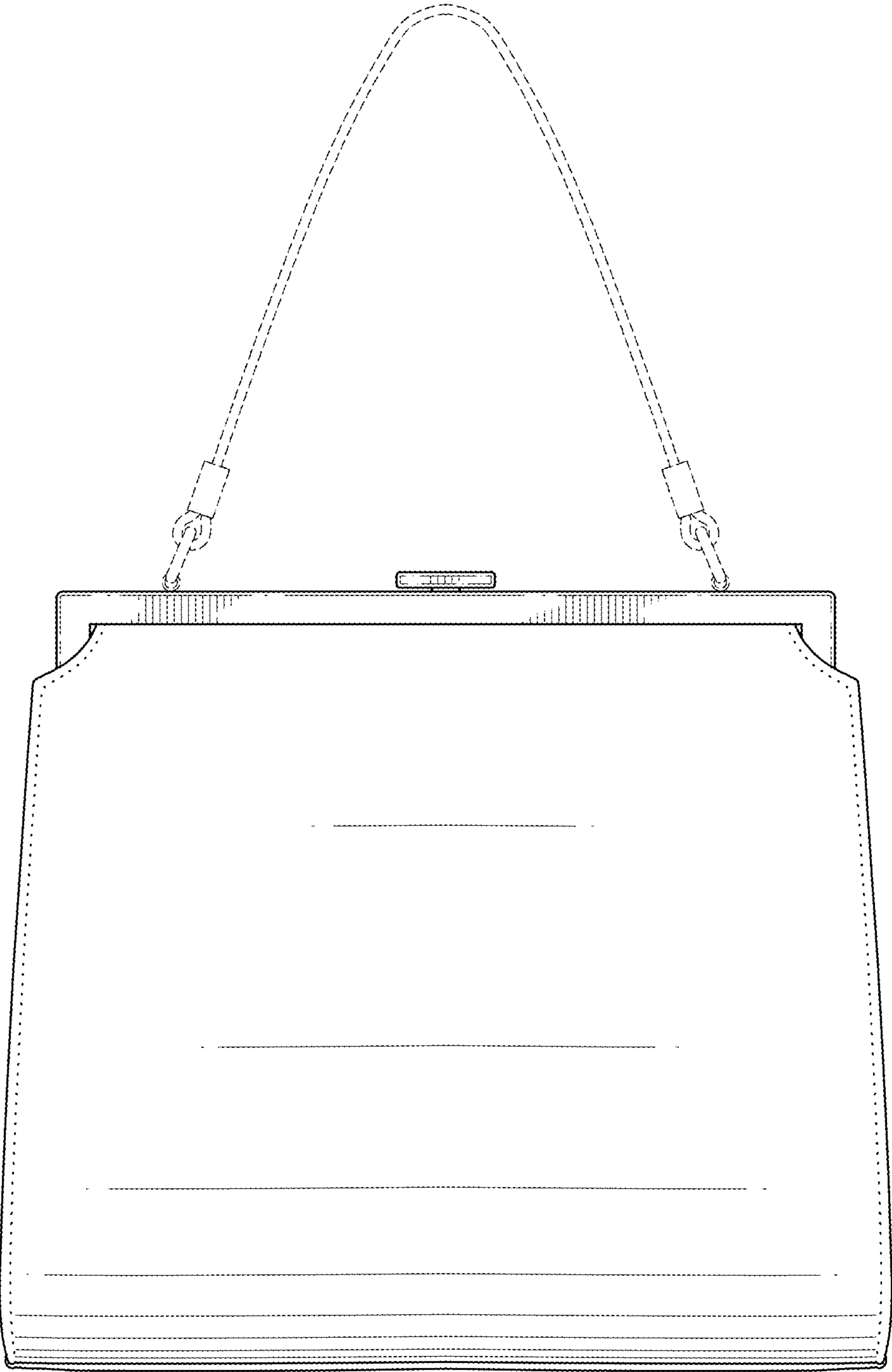

FIG. 3

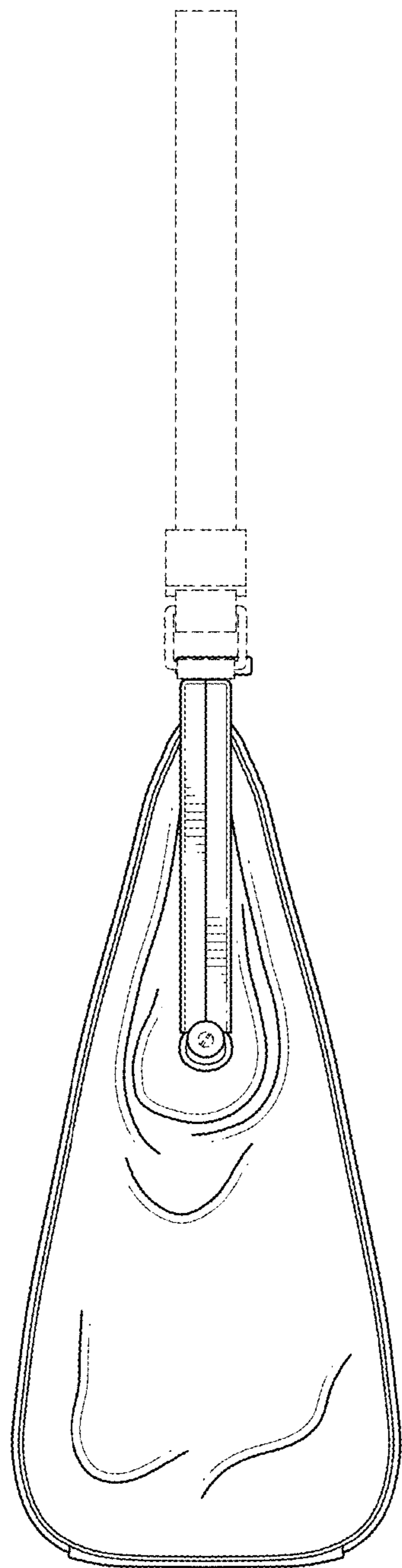

FIG. 4

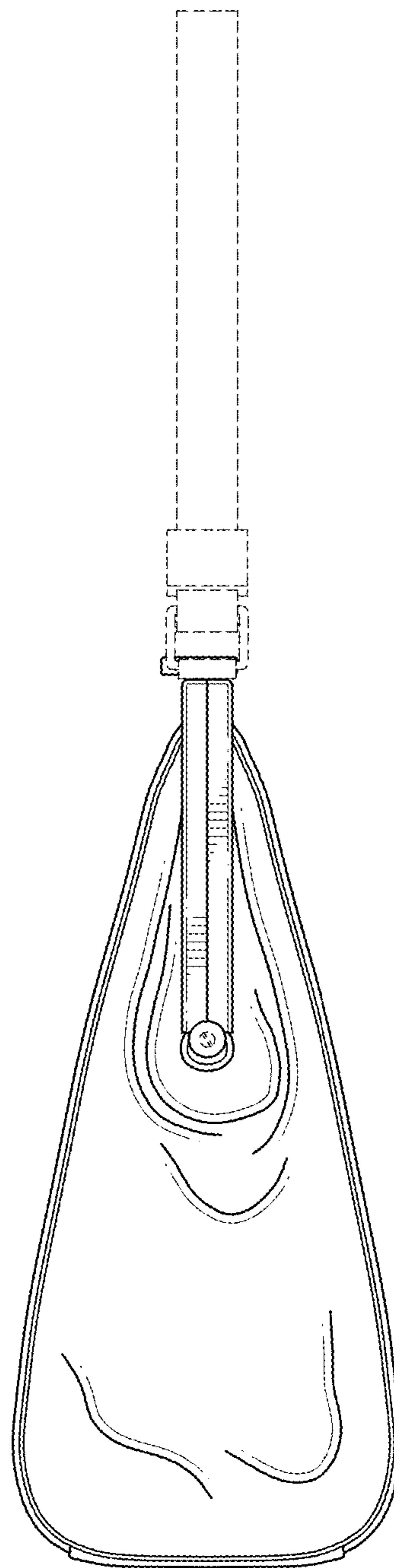

FIG. 5

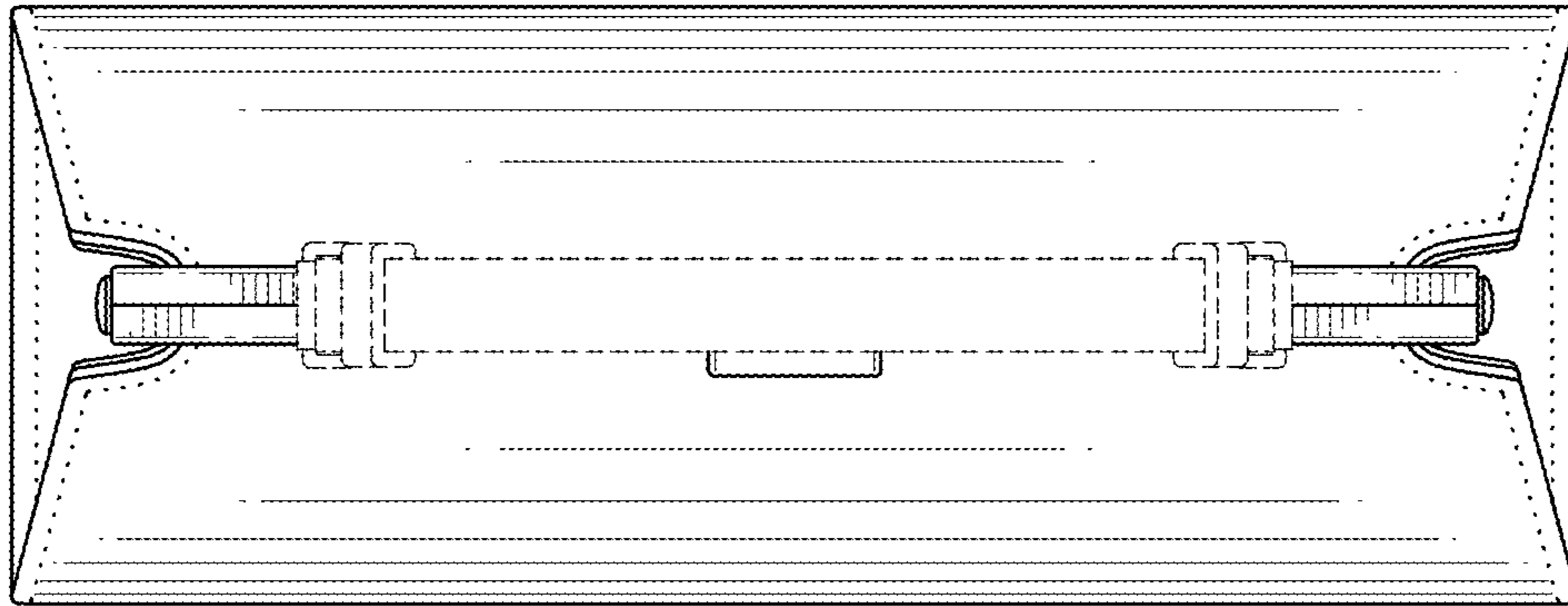

FIG. 6

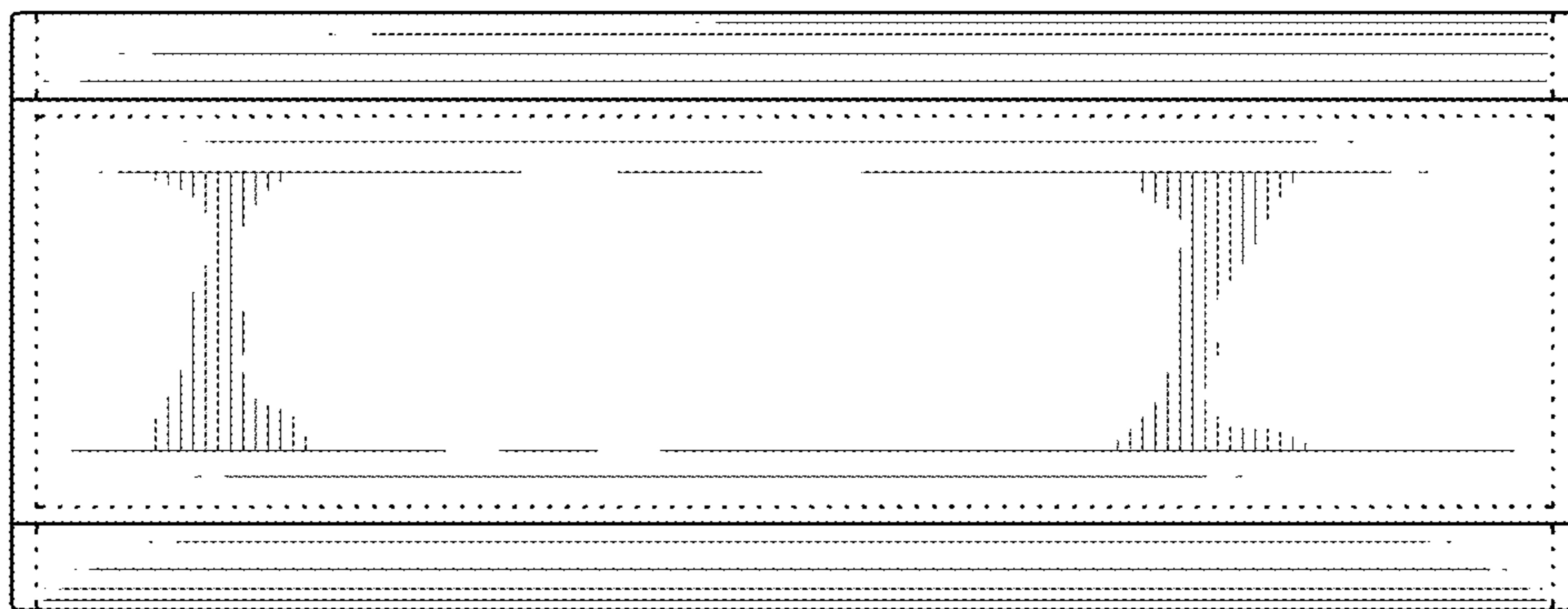

FIG. 7