



US00D772547S

(12) **United States Design Patent** (10) **Patent No.:** **US D772,547 S**  
**Raysse** (45) **Date of Patent:** **\*\* Nov. 29, 2016**

(54) **SHOE UPPER**  
(71) Applicant: **Skechers U.S.A., Inc. II**, Manhattan Beach, CA (US)  
(72) Inventor: **David Raysse**, Los Angeles, CA (US)  
(73) Assignee: **SKECHERS U.S.A., INC. II**, Manhattan Beach, CA (US)  
(\*\*) Term: **15 Years**  
(21) Appl. No.: **29/561,300**  
(22) Filed: **Apr. 14, 2016**  
(51) **LOC (10) Cl.** ..... **02-99**  
(52) **U.S. Cl.**  
USPC ..... **D2/969**  
(58) **Field of Classification Search**  
USPC ..... D2/902, 906-908, 919, 920, 923, 944, D2/969, 972-974, 977  
CPC A43B 13/181; A43B 13/141; A43B 13/186; A43B 13/188; A43B 23/00; A43B 23/02; A43B 5/00; A43B 23/26; A43B 1/04; A43B 11/14; A43B 7/00; A43C 1/00; A43C 11/00  
See application file for complete search history.

(56) **References Cited**  
U.S. PATENT DOCUMENTS  
D90,235 S 7/1933 Daniels  
D107,962 S \* 1/1938 Lanz ..... D2/923  
D186,155 S \* 9/1959 Bianchini ..... D2/923  
D245,127 S \* 7/1977 Fukuoka ..... D2/923  
D354,844 S \* 1/1995 Rinehart ..... D2/923  
D369,461 S \* 5/1996 Verin ..... D2/977  
D432,783 S \* 10/2000 Fallon ..... D2/972  
D434,551 S 12/2000 Snyder  
D457,296 S 5/2002 Burt  
D466,276 S 12/2002 Tomczak  
D475,523 S 6/2003 McDowell  
D475,846 S 6/2003 Lupo

D476,473 S 7/2003 Clegg  
D487,336 S 3/2004 Matis  
D499,863 S \* 12/2004 Sakai ..... D2/908  
D504,562 S 5/2005 Kuerbis  
D513,850 S 1/2006 Alfaro  
D515,301 S 2/2006 Gillespie  
D515,302 S 2/2006 Gillespie  
D522,734 S 6/2006 Lubrano  
D523,220 S \* 6/2006 Link ..... D2/972  
D523,226 S 6/2006 Hudson  
D523,227 S 6/2006 Fullum  
D524,028 S 7/2006 Fullum  
D533,339 S 12/2006 Edwards  
D536,516 S 2/2007 Sanders  
D546,543 S 7/2007 DiTullo, Jr.  
D548,940 S 8/2007 Hulbert  
D548,941 S 8/2007 Hulbert  
D556,436 S 12/2007 Wilkenfeld et al.  
D574,135 S \* 8/2008 Weisbly ..... D2/969

(Continued)

*Primary Examiner* — Dominic Simone  
(74) *Attorney, Agent, or Firm* — Marshall A. Lerner; Marvin H. Kleinberg; Kleinberg & Lerner, LLP

(57) **CLAIM**  
The ornamental design for a shoe upper, as shown and described.

**DESCRIPTION**

FIG. 1 is a perspective view of a first exemplary embodiment of a shoe upper in accordance with my new design. FIG. 2 is a left side view thereof; FIG. 3 is a right side view thereof; FIG. 4 is a top plan view thereof; FIG. 5 is a bottom plan view thereof; FIG. 6 is a rear elevation view thereof; and, FIG. 7 is a front elevation view thereof. Broken lines showing the remainder of the shoe in the figures are for illustrative purposes only and form no part of the claimed invention.

**1 Claim, 6 Drawing Sheets**

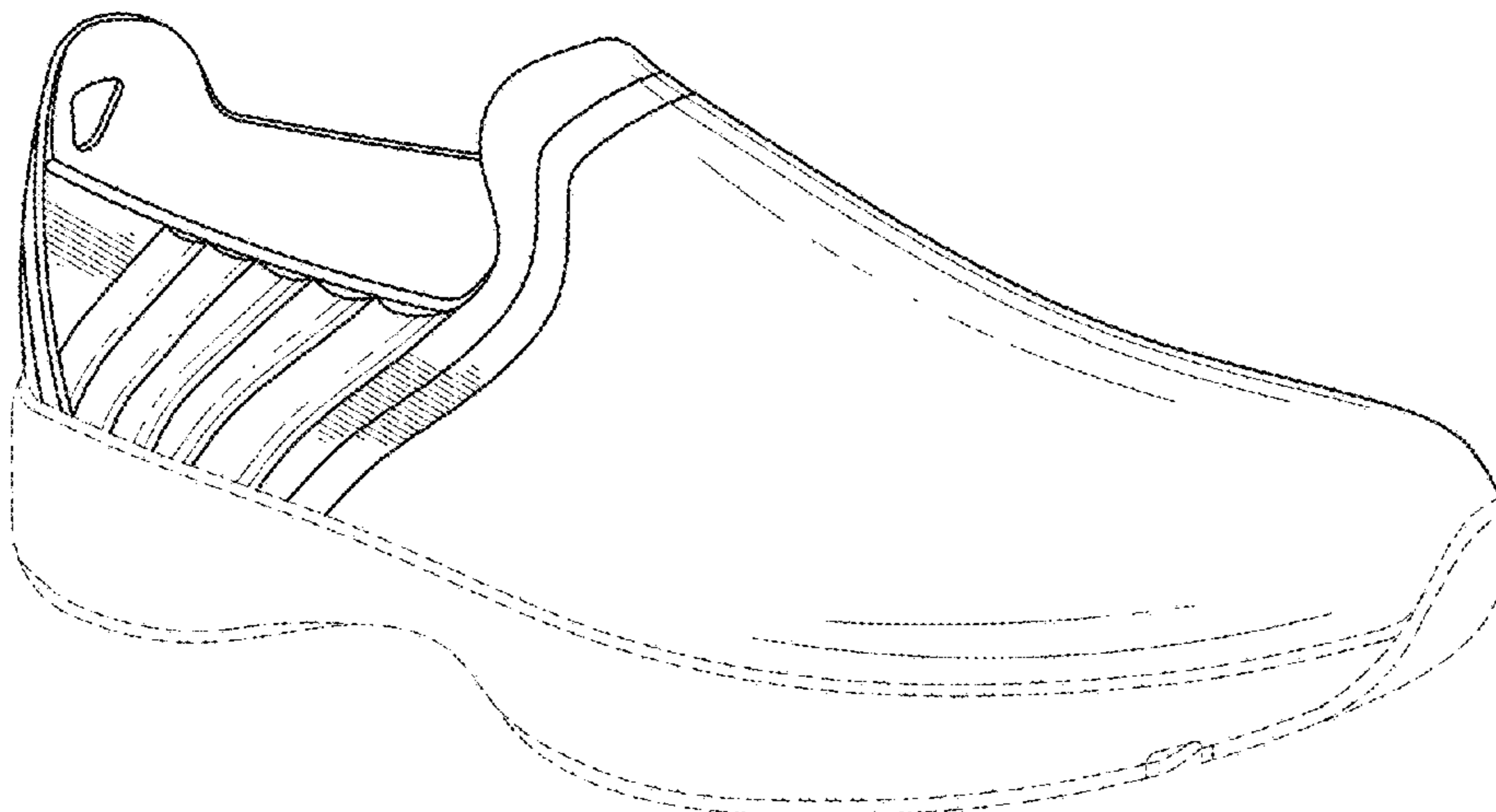

(56)

References Cited

U.S. PATENT DOCUMENTS

D580,156 S	*	11/2008	Banik .....	D2/969	D688,860 S	9/2013	Hrsak	
D586,110 S	*	2/2009	Lotti .....	D2/972	D688,861 S	9/2013	Hrsak	
D586,997 S	*	2/2009	Schoenborn .....	D2/969	D694,509 S	12/2013	Miner	
D594,641 S		6/2009	McDade et al.		D699,933 S	2/2014	Rasmussen	
D598,190 S		8/2009	Weber		D701,036 S	3/2014	Martin	
D605,386 S		12/2009	Cole		D701,037 S	3/2014	Ho et al.	
D624,297 S		9/2010	Henderson		D703,933 S	5/2014	Avar et al.	
D626,737 S	*	11/2010	Dean .....	D2/923	D705,530 S	*	5/2014	Teteriatnikov .....
D628,785 S		12/2010	Feeney et al.		D707,027 S	6/2014	Shaffer	D2/974
D636,568 S		4/2011	McMillan		D707,028 S	6/2014	Parker et al.	
D638,615 S		5/2011	McMillan		D707,943 S	7/2014	Nascimento	
D639,037 S	*	6/2011	McVicker .....	D2/923	D707,949 S	*	7/2014	VanHook .....
D658,869 S		5/2012	Miner		D707,950 S	7/2014	Williams, Jr.	D2/972
D659,367 S	*	5/2012	Hurayt .....	D2/923	D709,280 S	7/2014	Shaffer	
D659,373 S		5/2012	Miner		D713,631 S	9/2014	Millogo	
D659,374 S		5/2012	Miner		D716,540 S	11/2014	Anceresi et al.	
D666,799 S		9/2012	Now		D718,034 S	*	11/2014	Hardman .....
D668,858 S		10/2012	Shaffer		D718,036 S	11/2014	McMillan	D2/972
D675,424 S		2/2013	Williams, Jr.		D721,479 S	1/2015	de Montgolfier	
D676,223 S		2/2013	Dill		D722,224 S	2/2015	Williams, Jr.	
D680,710 S		4/2013	Sundberg		D722,225 S	2/2015	Williams, Jr.	
D682,535 S		5/2013	Dekovic		D723,788 S	*	3/2015	Raysse .....
D683,944 S		6/2013	Dolce		D725,895 S	4/2015	Cin	D2/969
D684,343 S		6/2013	Sundberg		D731,164 S	6/2015	Williams, Jr.	
D684,344 S		6/2013	Sundberg		D740,012 S	10/2015	O'Connor	
D684,761 S		6/2013	Williams, Jr.		D744,223 S	12/2015	Kirschner	
D685,170 S	*	7/2013	Raysse .....	D2/923	D745,258 S	12/2015	Raysse	
D687,622 S		8/2013	Tzenos et al.		D745,259 S	12/2015	Bell et al.	
D688,446 S	*	8/2013	Raysse .....	D2/923	D746,035 S	12/2015	Bell et al.	
					D746,571 S	1/2016	Bell et al.	
					D746,572 S	1/2016	Bell et al.	
					D747,089 S	1/2016	Bell et al.	

\* cited by examiner

FIG. 1

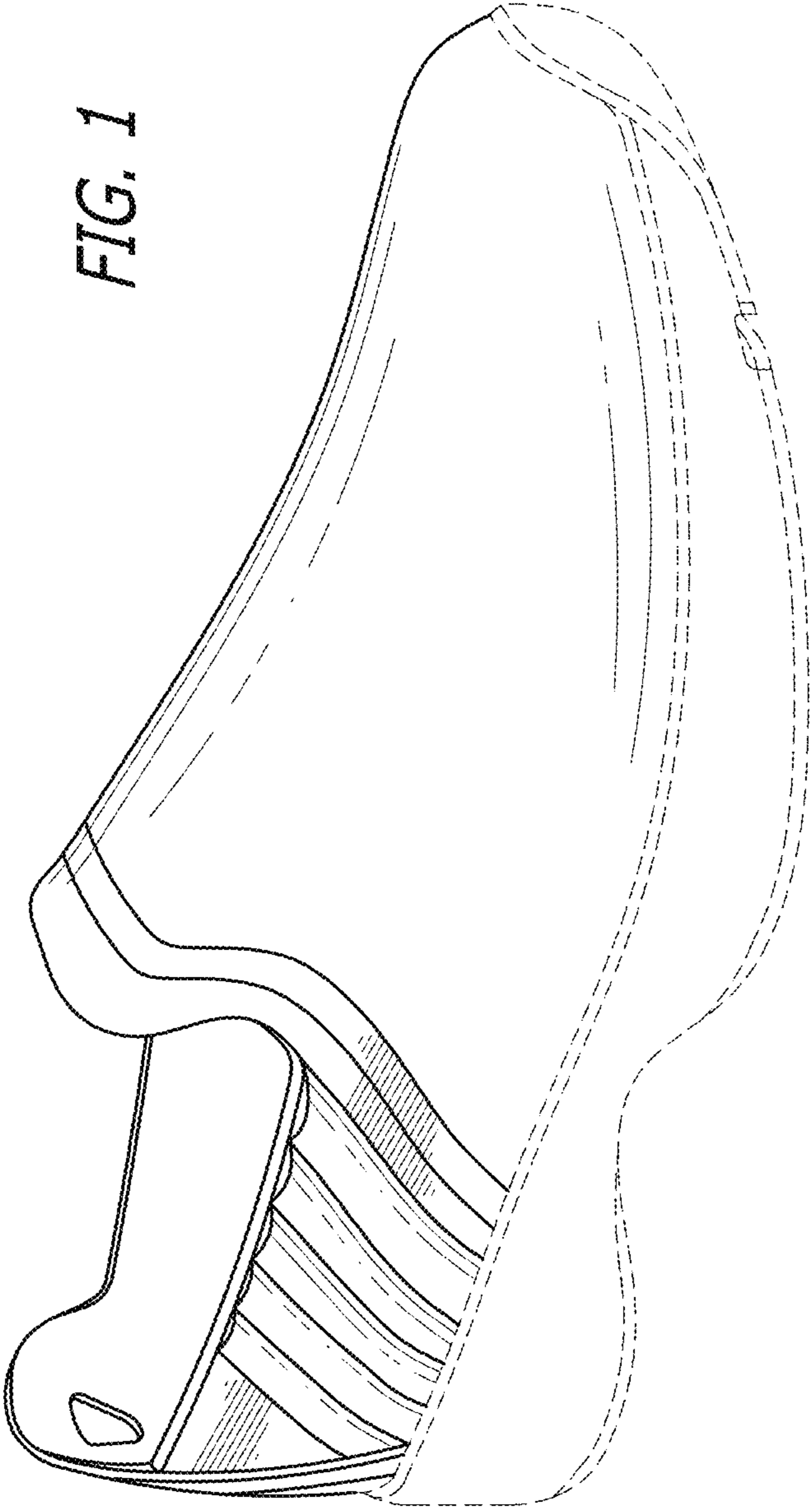

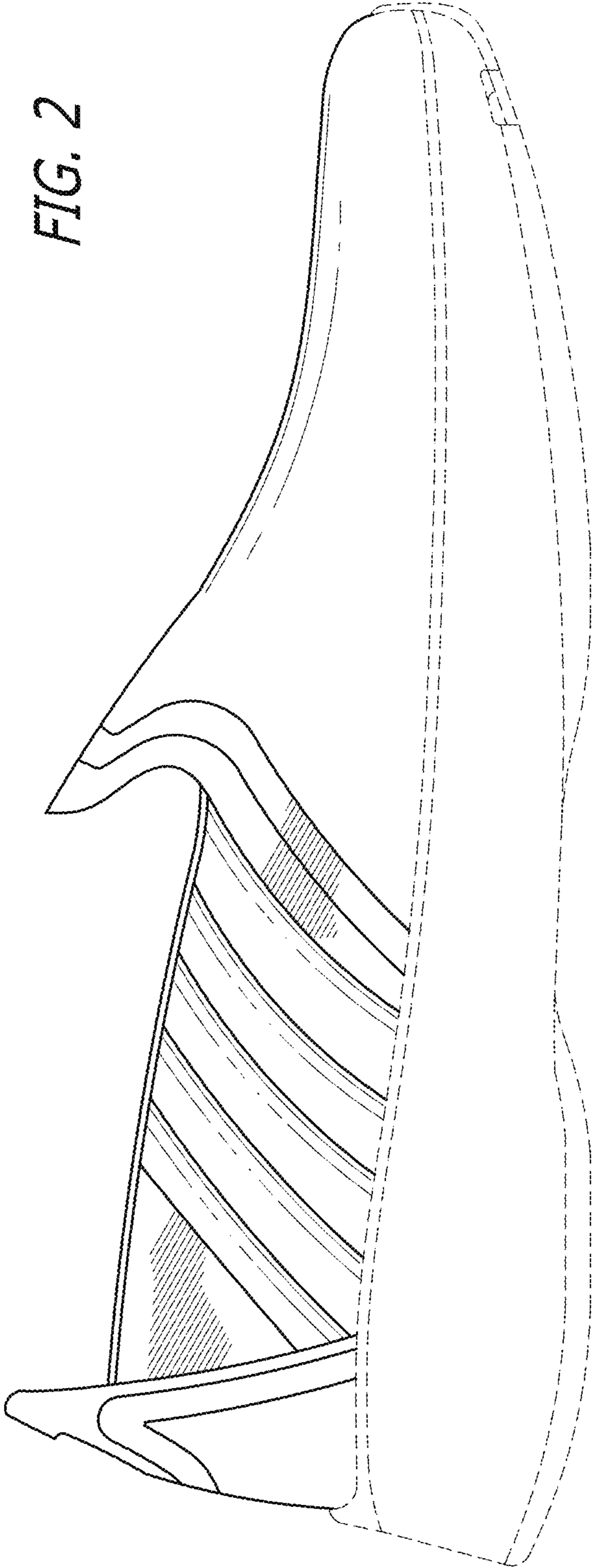

FIG. 2

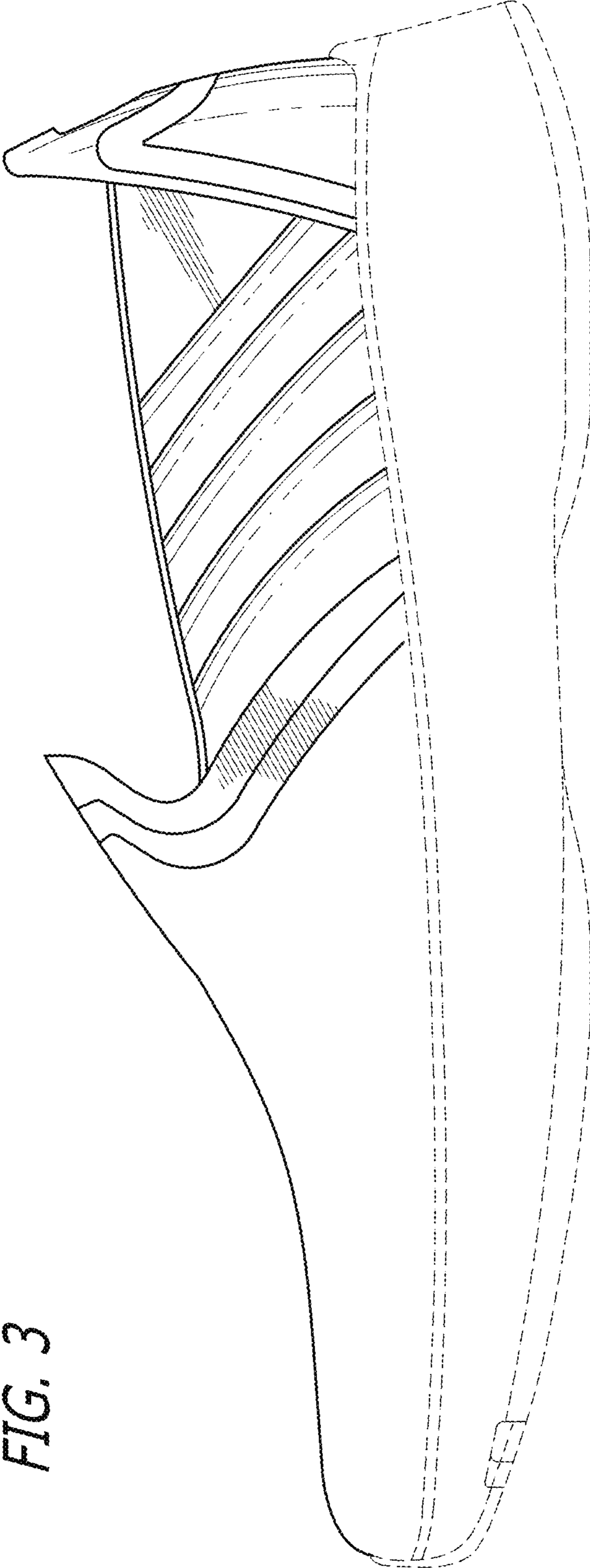
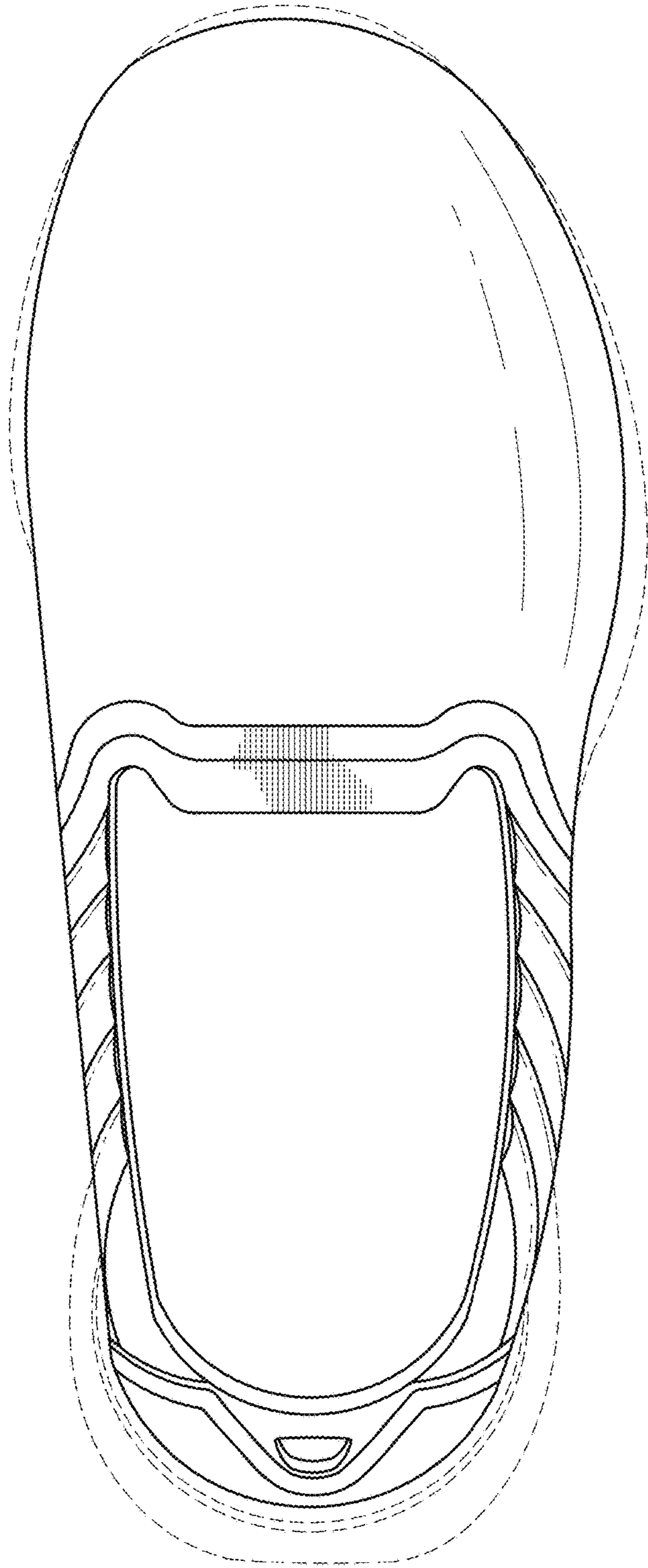

FIG. 3

FIG. 4



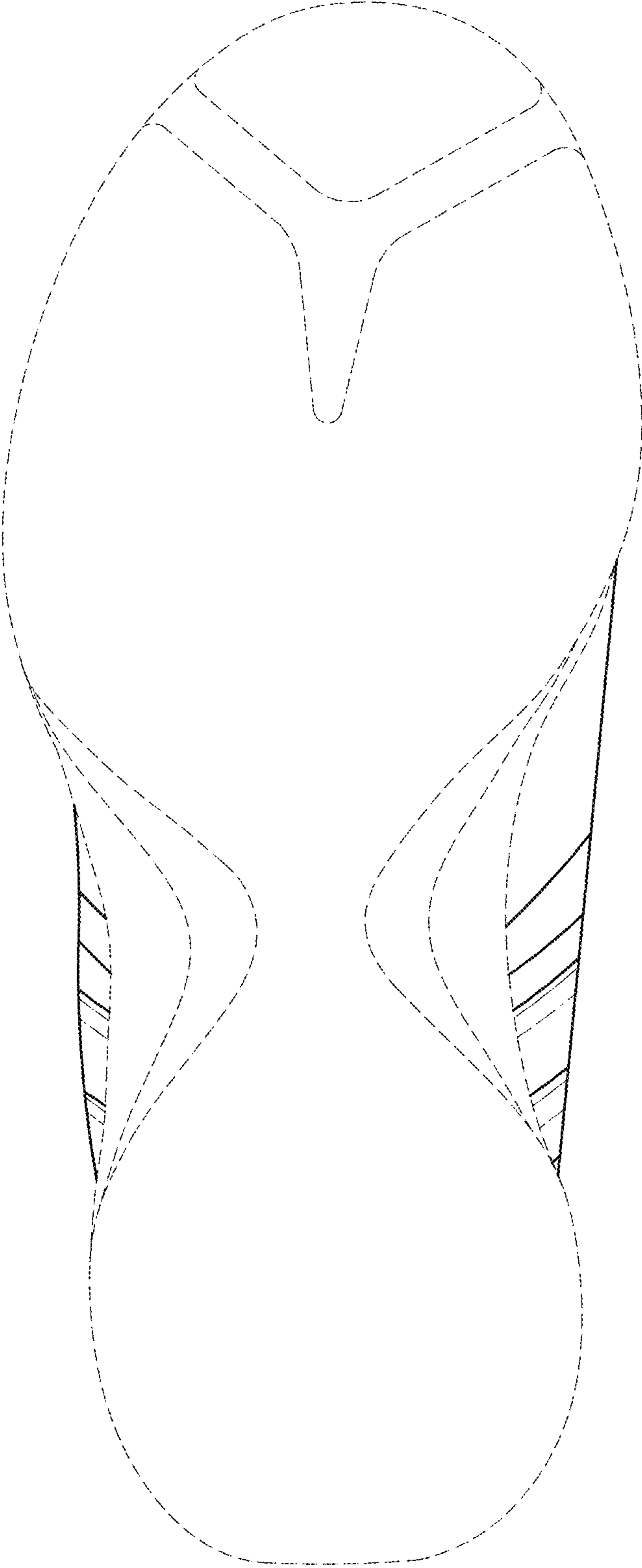

FIG. 5

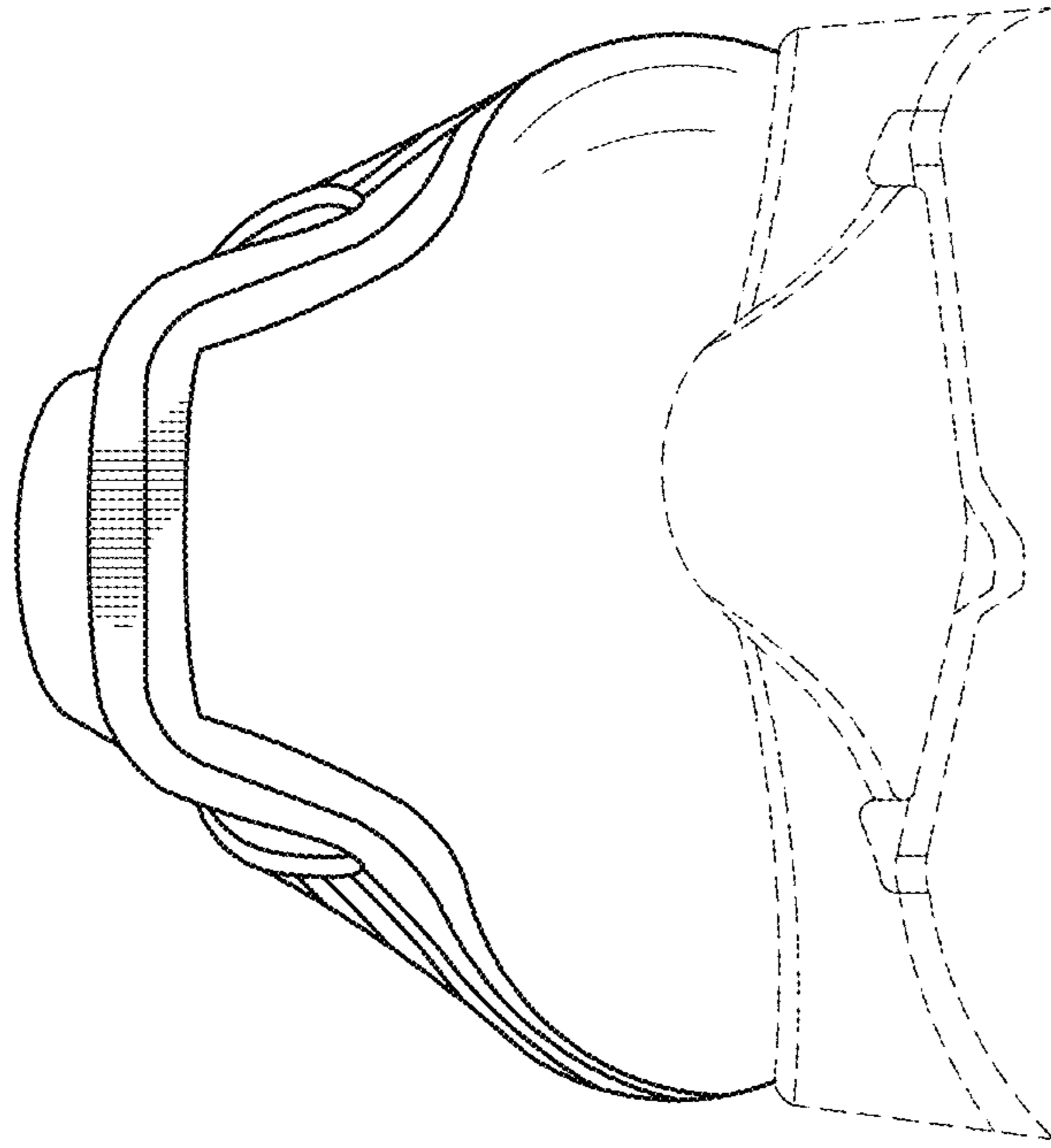

FIG. 6

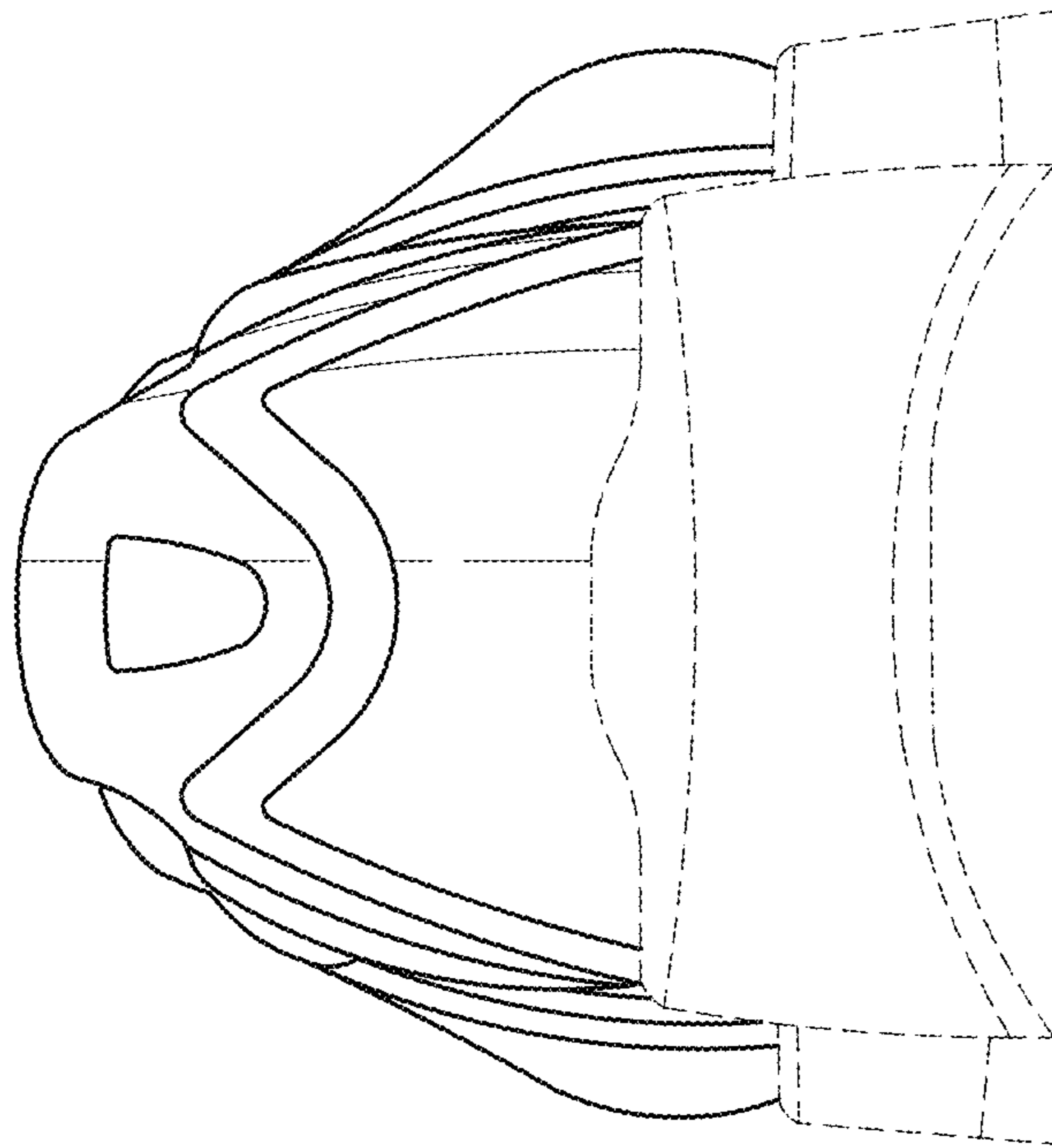

FIG. 7