



US00D772510S

(12) **United States Design Patent**
Palladino

(10) **Patent No.:** **US D772,510 S**

(45) **Date of Patent:** **** Nov. 22, 2016**

(54) **COMBINED HANDLE AND HEAD**

(71) Applicant: **SharkNinja Operating LLC**, Newton, MA (US)

(72) Inventor: **Gary Palladino**, Somerville, MA (US)

(73) Assignee: **SharkNinja Operating LLC**, Newton, MA (US)

(**) Term: **14 Years**

(21) Appl. No.: **29/487,522**

(22) Filed: **Apr. 9, 2014**

(51) **LOC (10) Cl.** **15-05**

(52) **U.S. Cl.**
USPC **D32/31**

(58) **Field of Classification Search**
USPC D32/22, 32-34
CPC A47L 19/02; A47L 19/06; A47L 15/362;
A47L 15/365; A47L 15/36; A47L 15/24;
A47L 15/28; A47L 15/34; A47L 7/06;
A47L 11/4044; A47L 9/325
See application file for complete search history.

(56) **References Cited**

U.S. PATENT DOCUMENTS

D426,356 S *	6/2000	Tsuruha	D32/22
D429,392 S *	8/2000	Maruyama et al.	D32/22
D433,546 S *	11/2000	Milanese	D32/22
D465,623 S *	11/2002	Main et al.	D32/22
D507,387 S *	7/2005	Jacobs	D32/22
D561,959 S *	2/2008	Hahn	D32/22
D591,918 S *	5/2009	Vaggies	D32/22
D598,616 S *	8/2009	Crawley	D32/22
D608,513 S *	1/2010	Ho	D32/22
D635,728 S *	4/2011	Fjellman	D32/22

D682,496 S *	5/2013	Bassett et al.	D32/22
D694,481 S *	11/2013	Grey et al.	D32/22
D738,584 S *	9/2015	Niedzwecki	D32/22

FOREIGN PATENT DOCUMENTS

JP	1365190 S	7/2009
JP	1449750 S	8/2012

OTHER PUBLICATIONS

Examiner Notice from Japanese Design No. 2014-022719 dated Jun. 30, 2015. (English and Japanese Translation).

* cited by examiner

Primary Examiner — Ruth McInroy

(74) *Attorney, Agent, or Firm* — Grossman Tucker Perreault & Pflieger, PLLC

(57) **CLAIM**

The ornamental design for a combined handle and head, as shown and described.

DESCRIPTION

FIG. 1 is a perspective view of a combined handle and head showing my new design;

FIG. 2 is a front view thereof;

FIG. 3 is a rear view thereof;

FIG. 4 is a right side view thereof;

FIG. 5 is a left side view thereof; and,

FIG. 6 is an enlarged top view thereof.

The details shown in broken lines form no part of the claimed design.

1 Claim, 6 Drawing Sheets

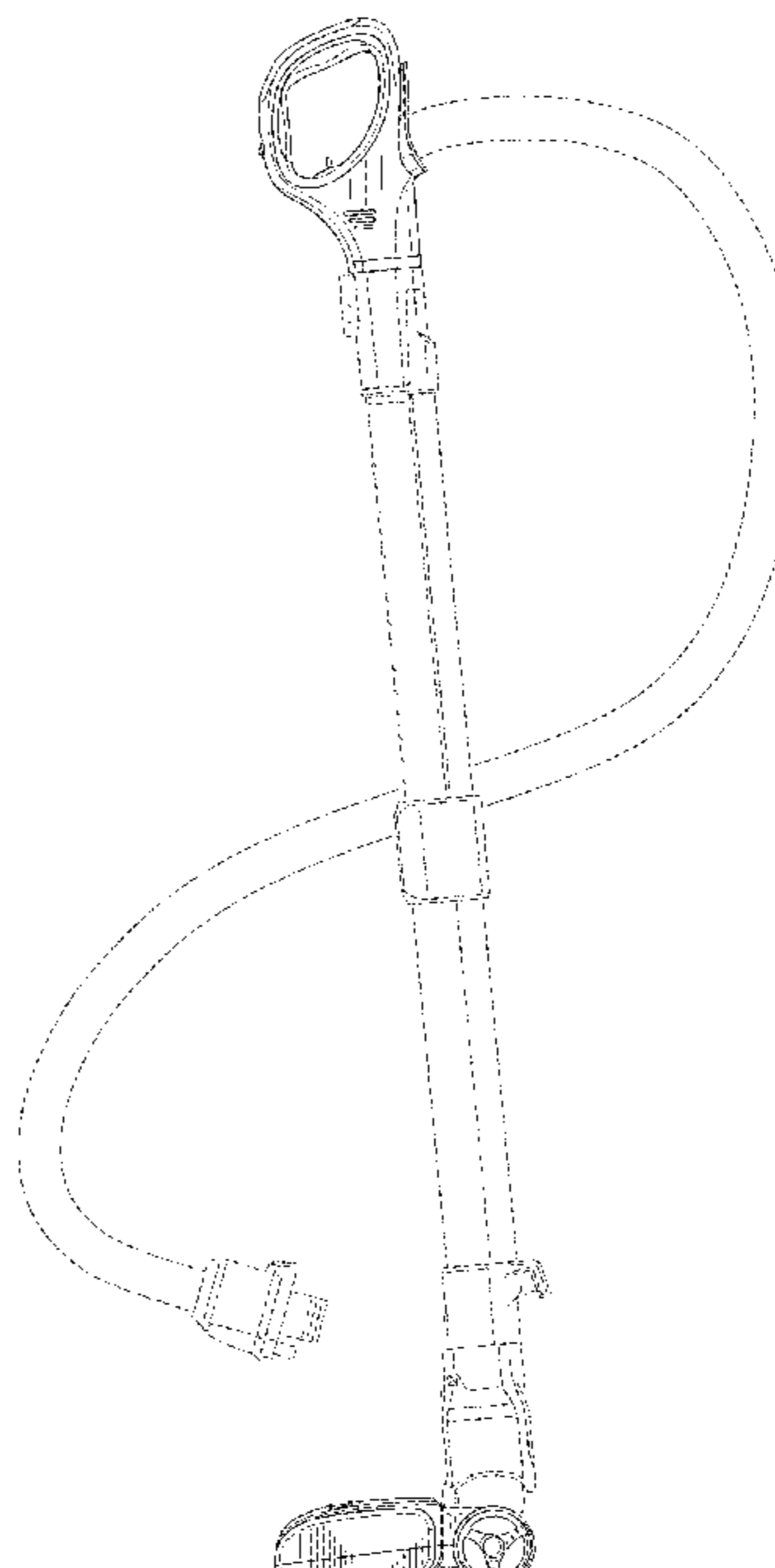
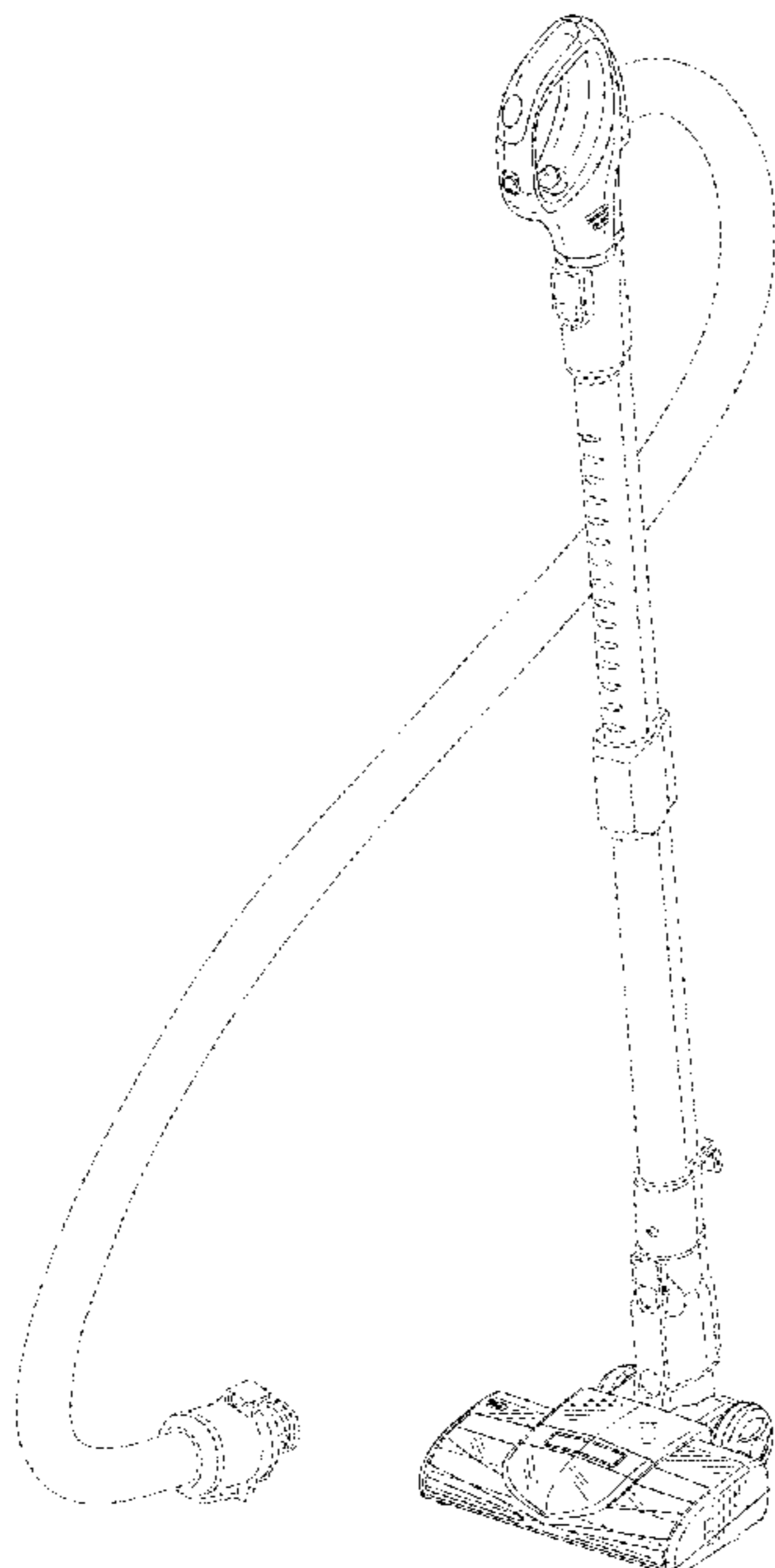
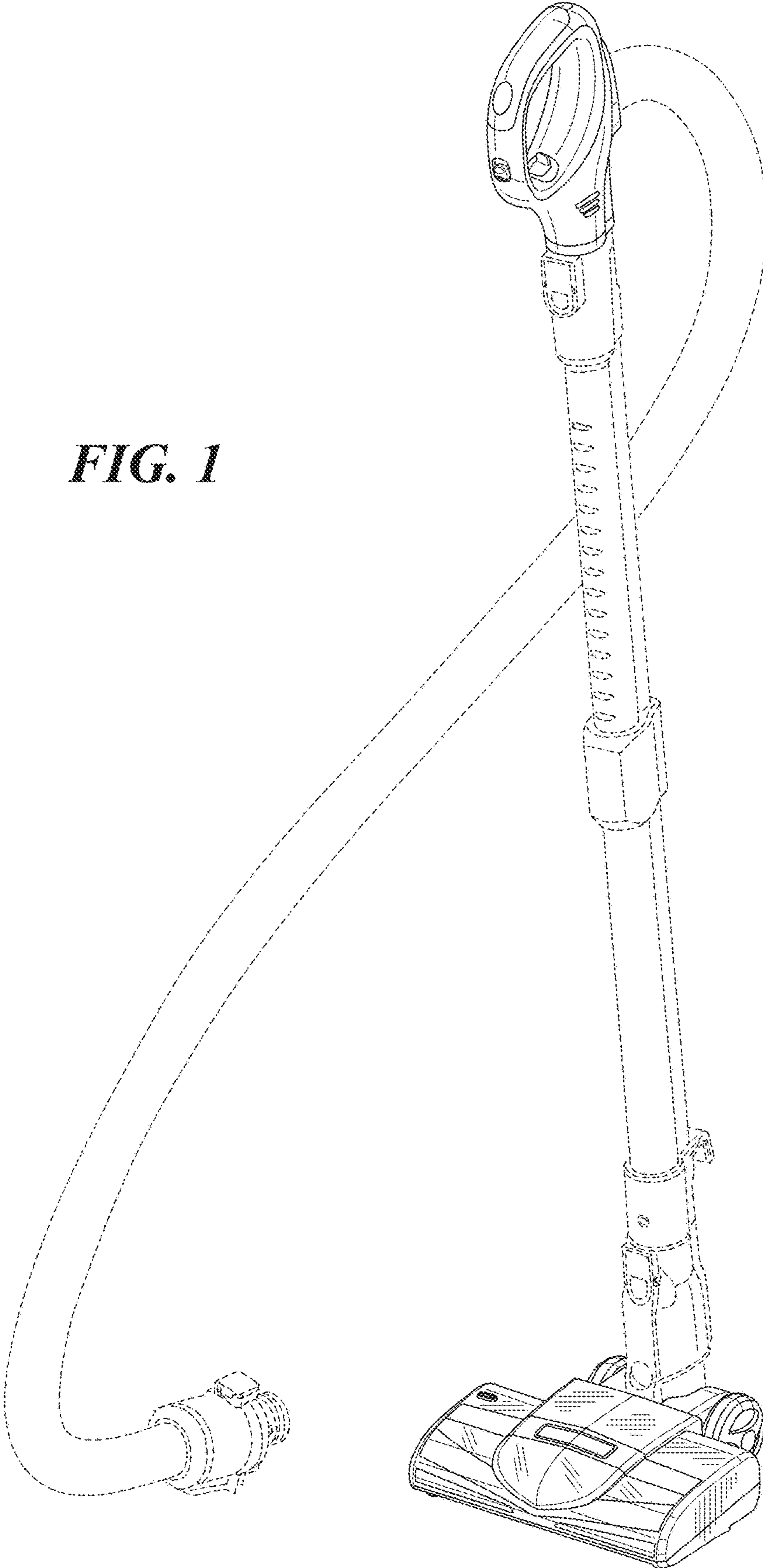

FIG. 1



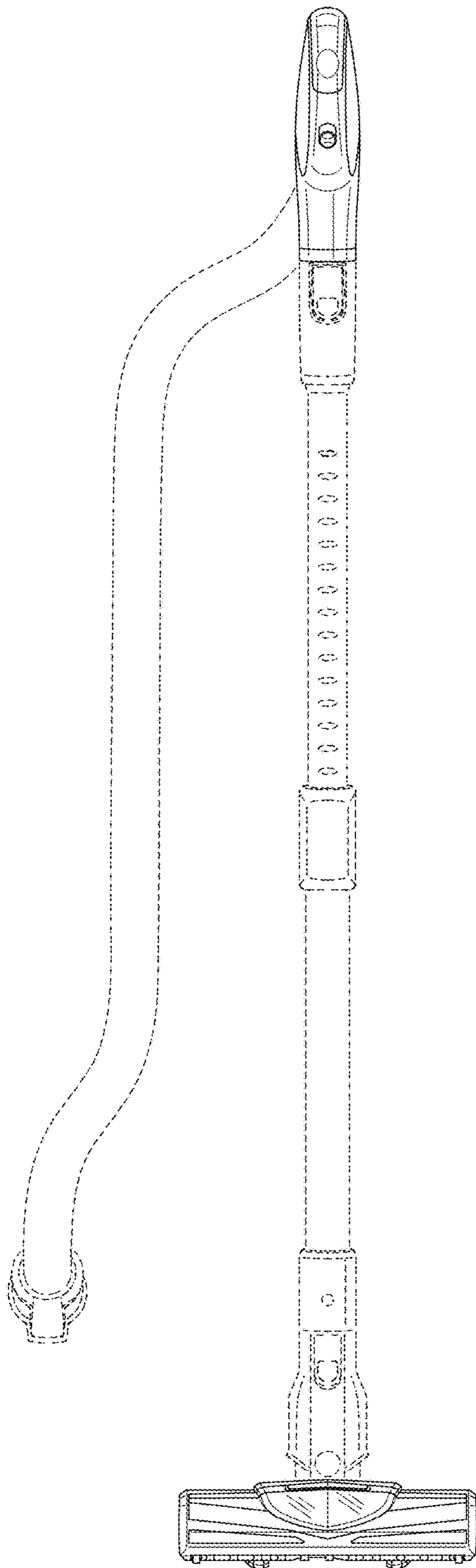

FIG. 2

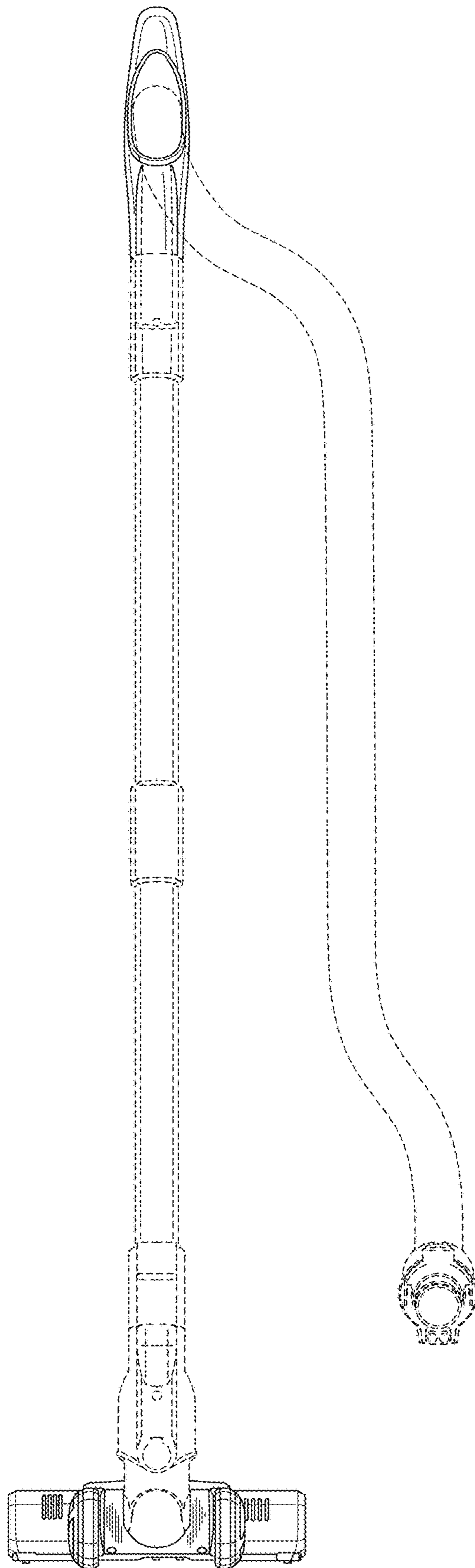

FIG. 3

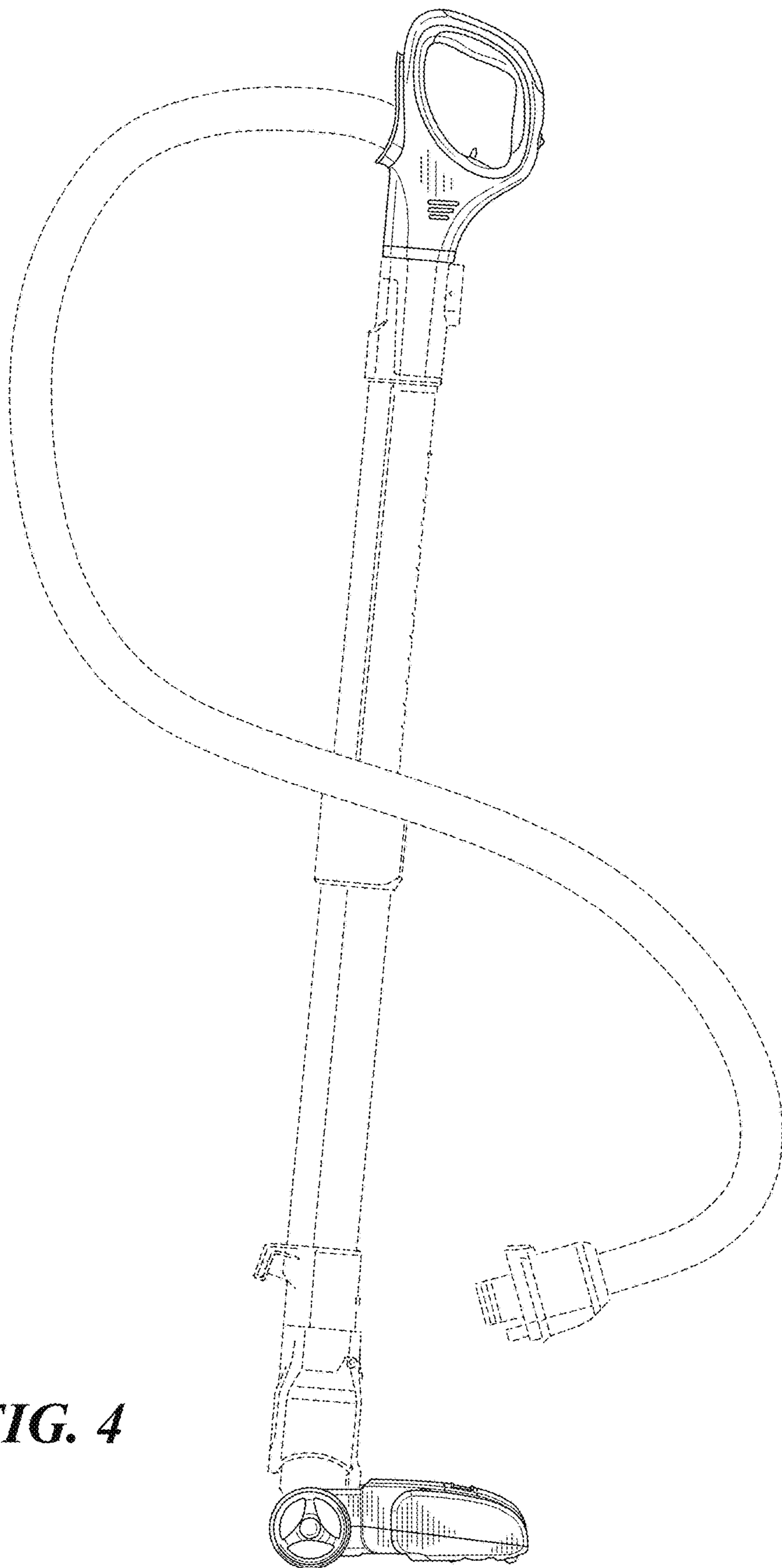

FIG. 4

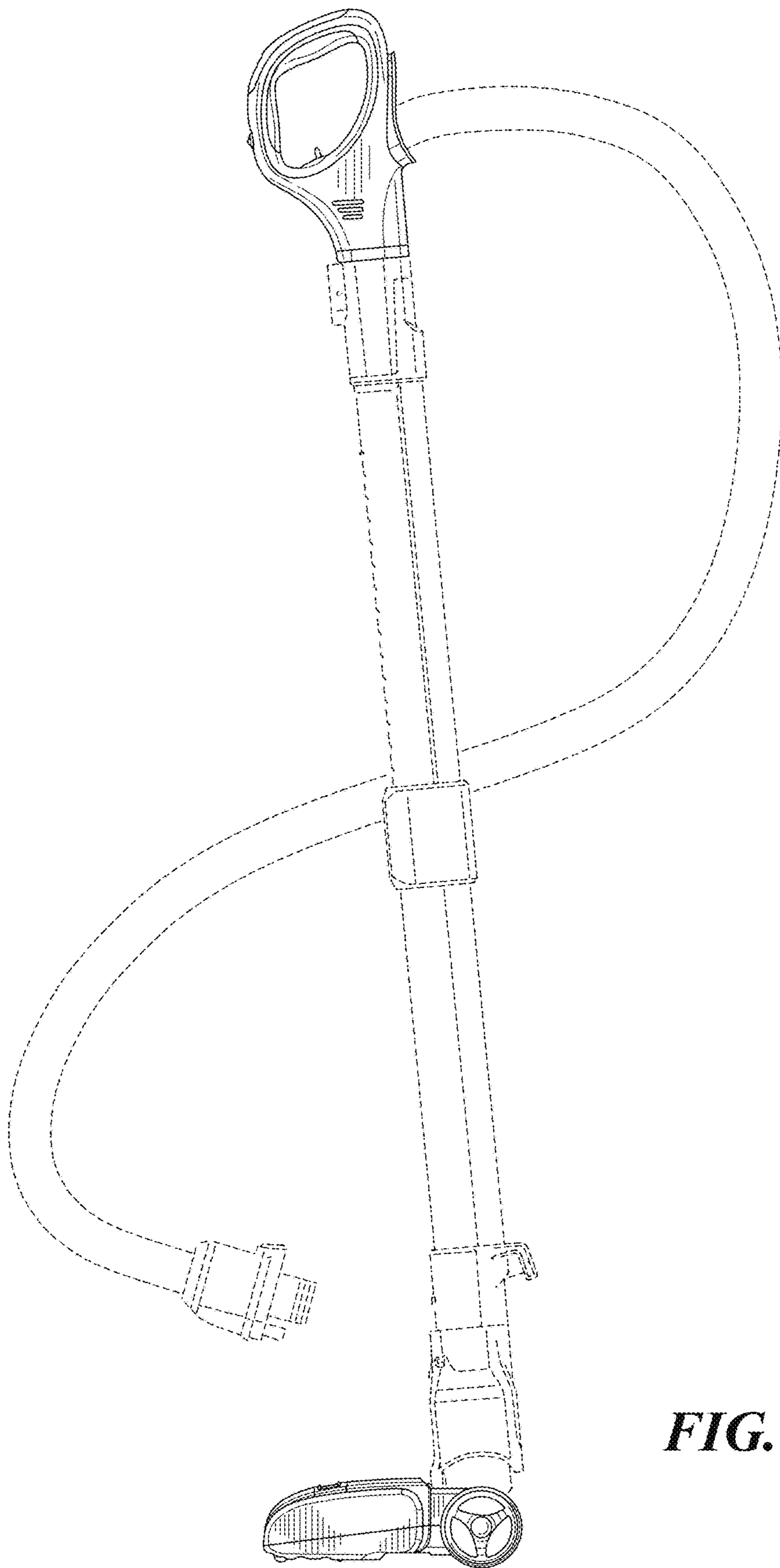

FIG. 5

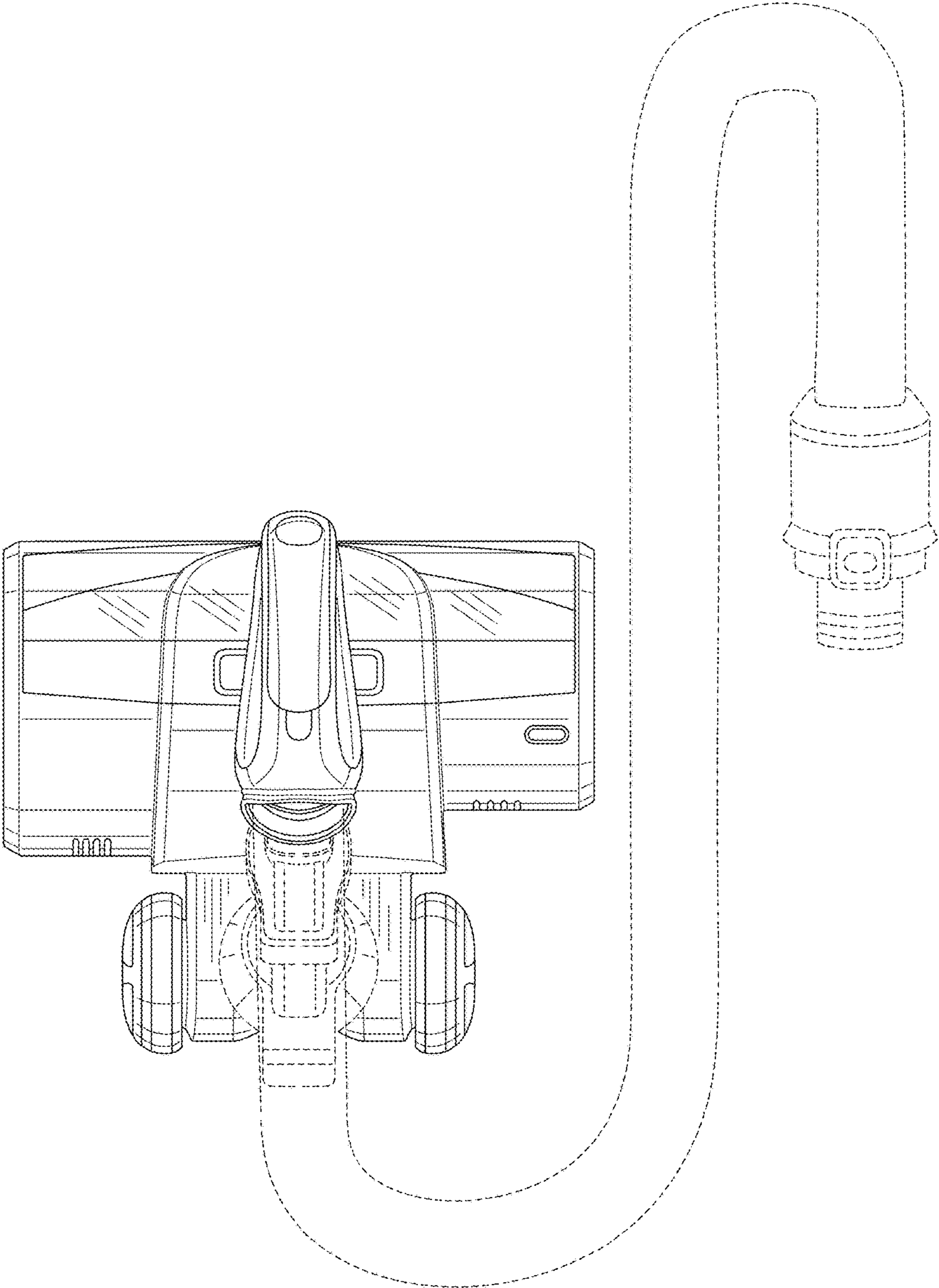

FIG. 6