



US00D772441S

(12) **United States Design Patent** (10) **Patent No.:** **US D772,441 S**
Burke (45) **Date of Patent:** **** Nov. 22, 2016**

- (54) **NIGHT LIGHT**
- (71) Applicant: **Marde Burke**, Edmond, OK (US)
- (72) Inventor: **Marde Burke**, Edmond, OK (US)
- (**) Term: **14 Years**
- (21) Appl. No.: **29/522,162**
- (22) Filed: **Mar. 27, 2015**
- (51) **LOC (10) Cl.** **26-05**
- (52) **U.S. Cl.**
USPC **D26/26**
- (58) **Field of Classification Search**
USPC D26/26, 24, 113, 118, 119, 120;
D23/366, 367, 369; 362/640, 641, 642,
362/643, 644, 650, 651, 652, 653, 659
CPC F21S 8/035; F21V 23/06; F21V 23/0442;
F21W 2121/00; H01R 2103/00
See application file for complete search history.

- D434,863 S * 12/2000 Boessel D26/26
- D492,799 S * 7/2004 Friedman D26/26
- D618,831 S * 6/2010 Pennington D26/26
- D642,707 S * 8/2011 Kang D26/26
- D642,709 S * 8/2011 Kang D26/26
- 2002/0163796 A1* 11/2002 Dickie H05B 33/02
362/84
- 2013/0221859 A1* 8/2013 Pavelchak F21S 8/035
315/159

* cited by examiner

Primary Examiner — Angela J Lee

(74) *Attorney, Agent, or Firm* — Resolution Legal Group;
Bruce LaBrie

(57) **CLAIM**

The ornamental design for a night light, as shown and described.

DESCRIPTION

FIG. 1 is a left elevational view of a night light comprising the new design;
FIG. 2 is a front elevational view;
FIG. 3 is a right elevational view;
FIG. 4 is a rear elevational view;
FIG. 5 is a top view;
FIG. 6 is a bottom view; and,
FIG. 7 is a perspective view.

The broken lines included in the drawings are for illustrative purposes and form no part of the claimed design.

1 Claim, 1 Drawing Sheet

(56) **References Cited**

U.S. PATENT DOCUMENTS

- D323,898 S * 2/1992 Schwartz D26/26
- D343,015 S * 1/1994 Yuen D26/26
- D350,407 S * 9/1994 Yuen D26/26
- D357,330 S * 4/1995 Wong D23/328
- D366,127 S * 1/1996 Yuen D26/26
- D431,660 S * 10/2000 Yuen D26/26

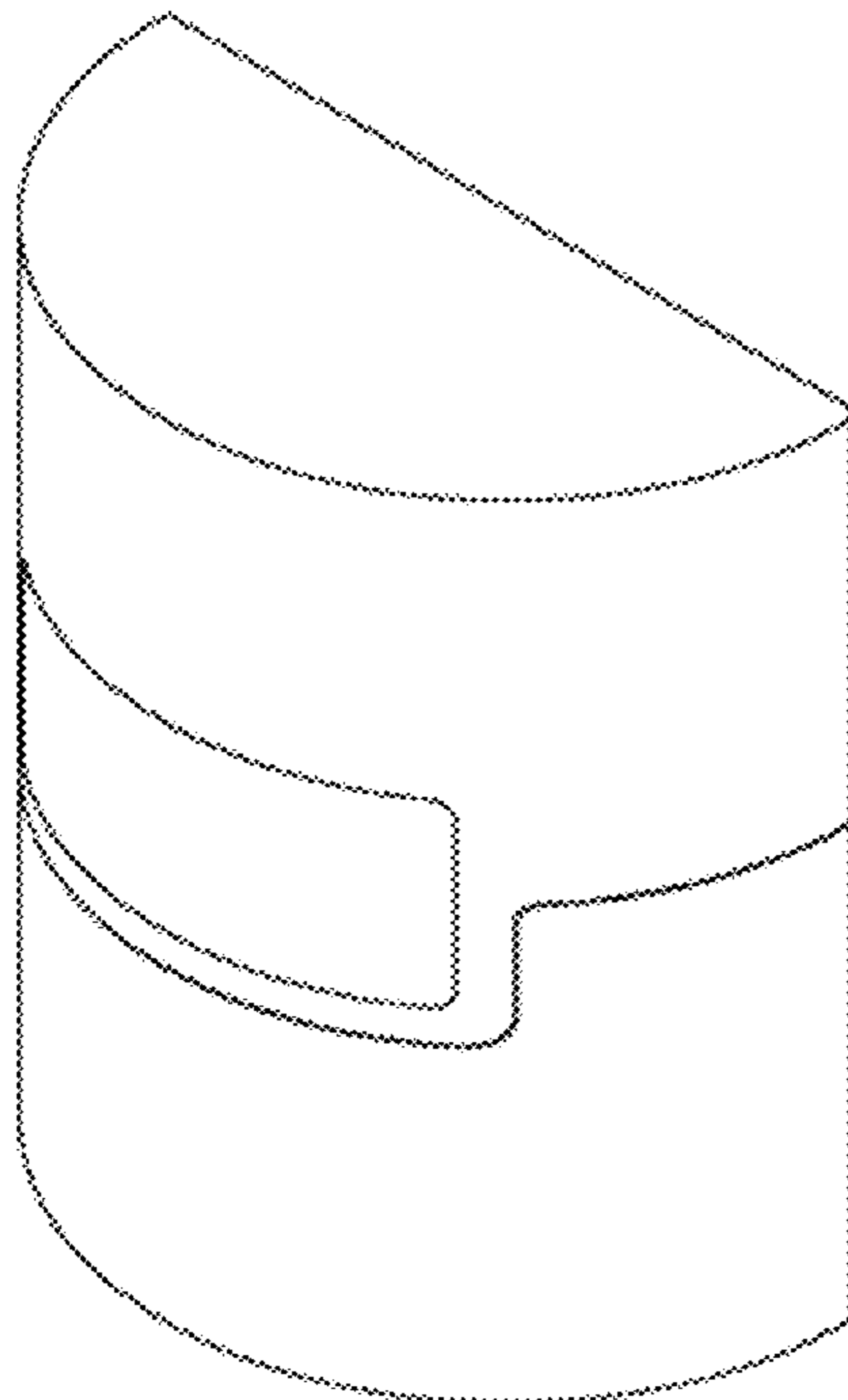

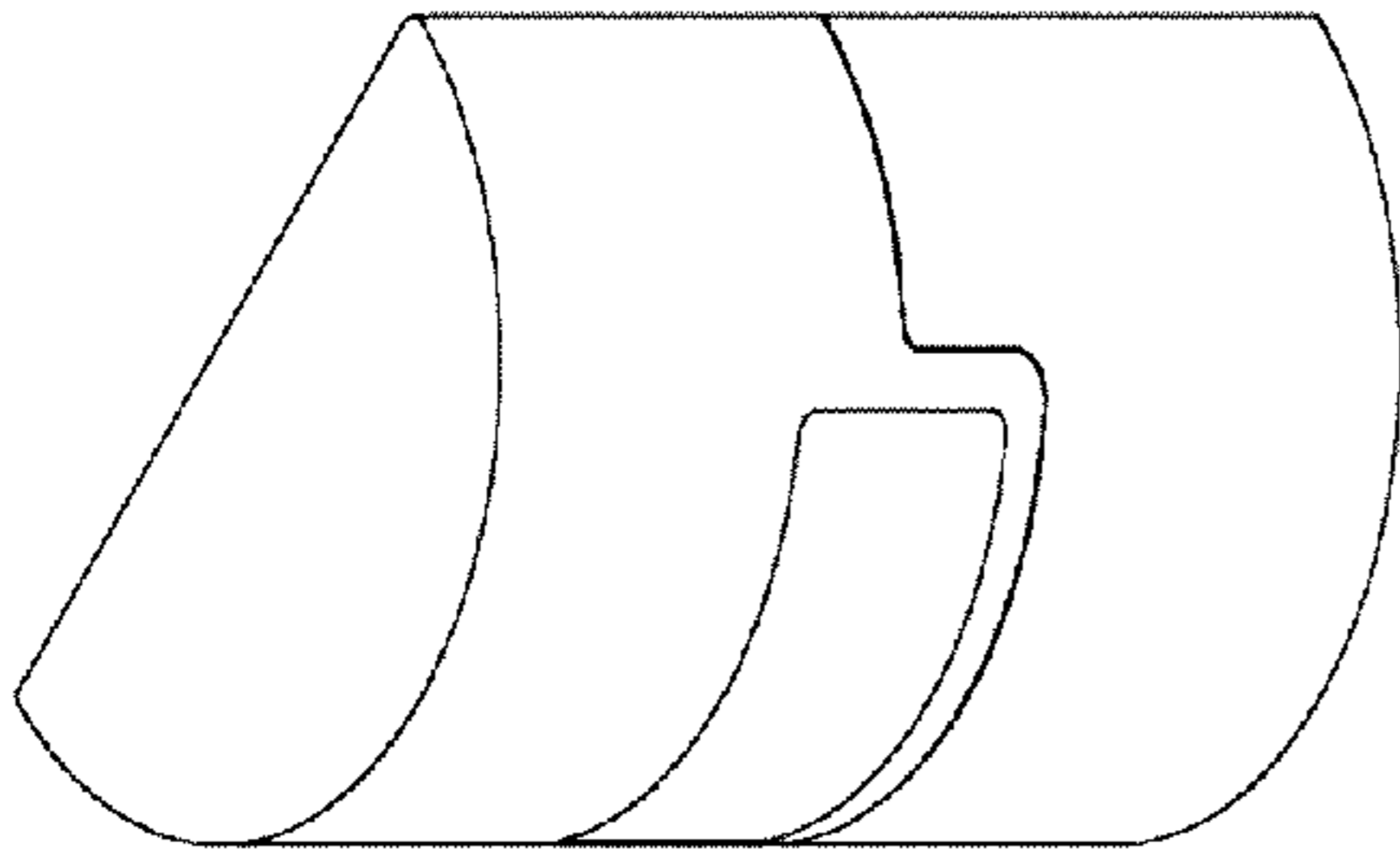

Figure 7

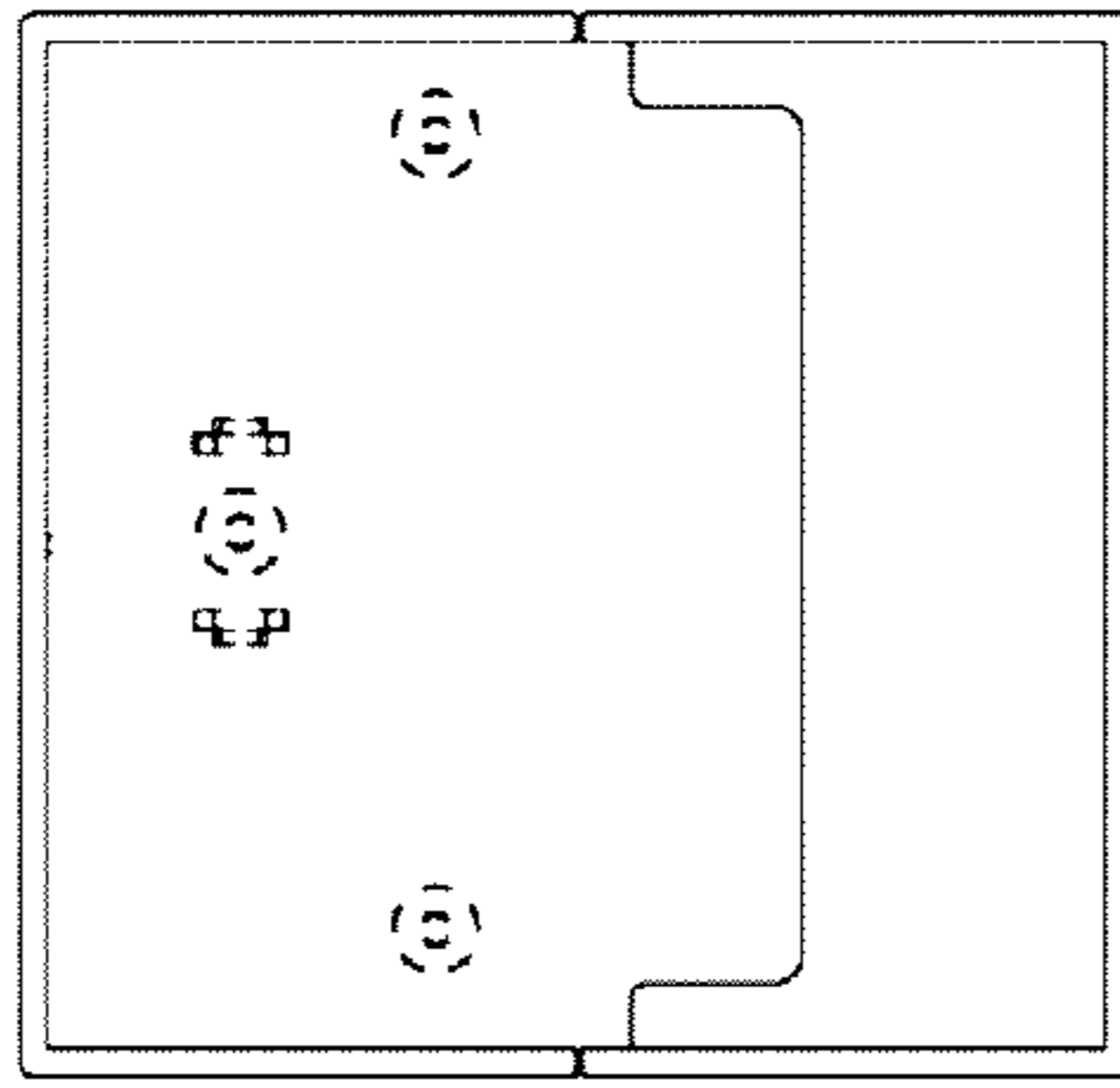

Figure 4

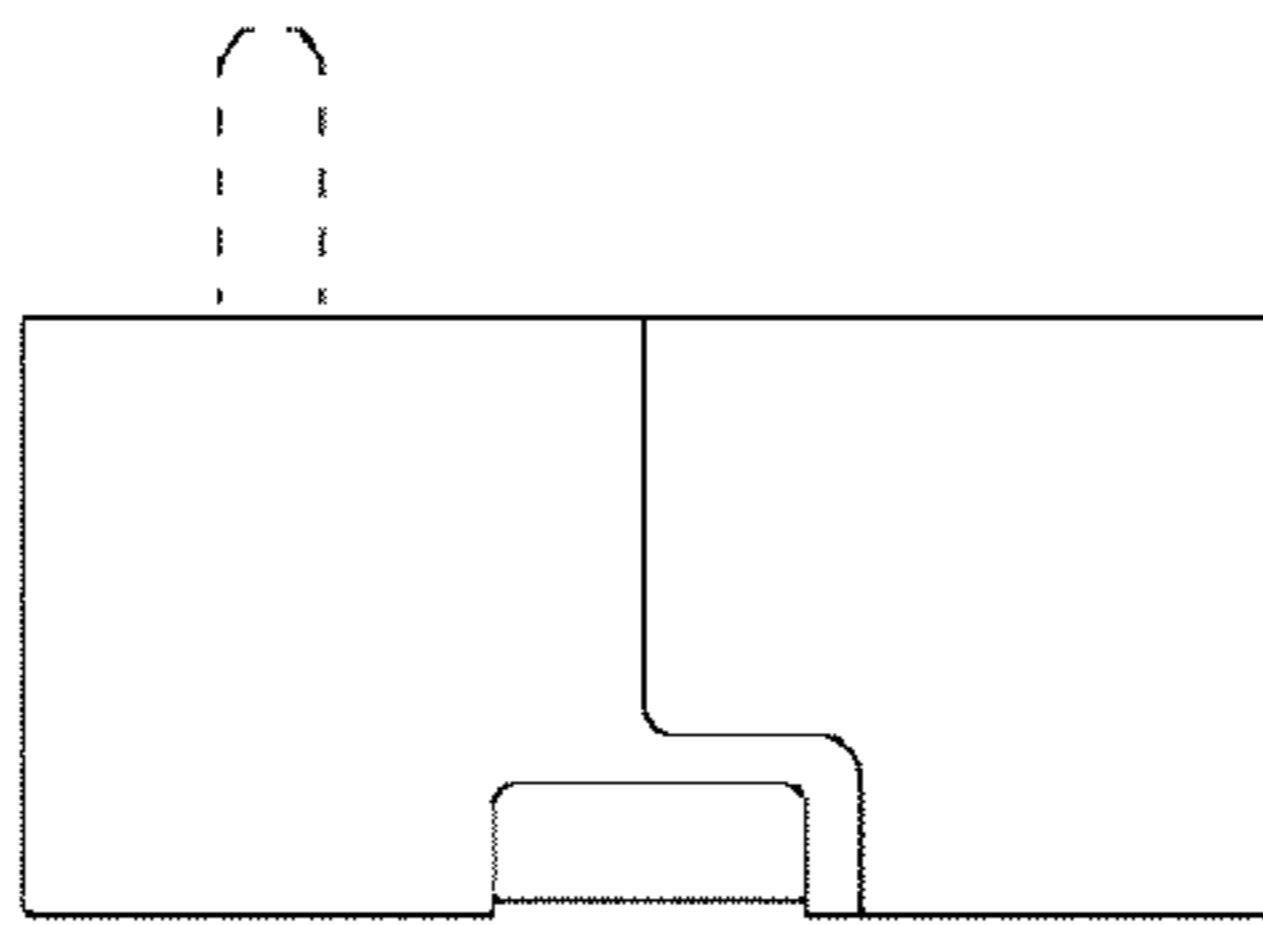

Figure 3

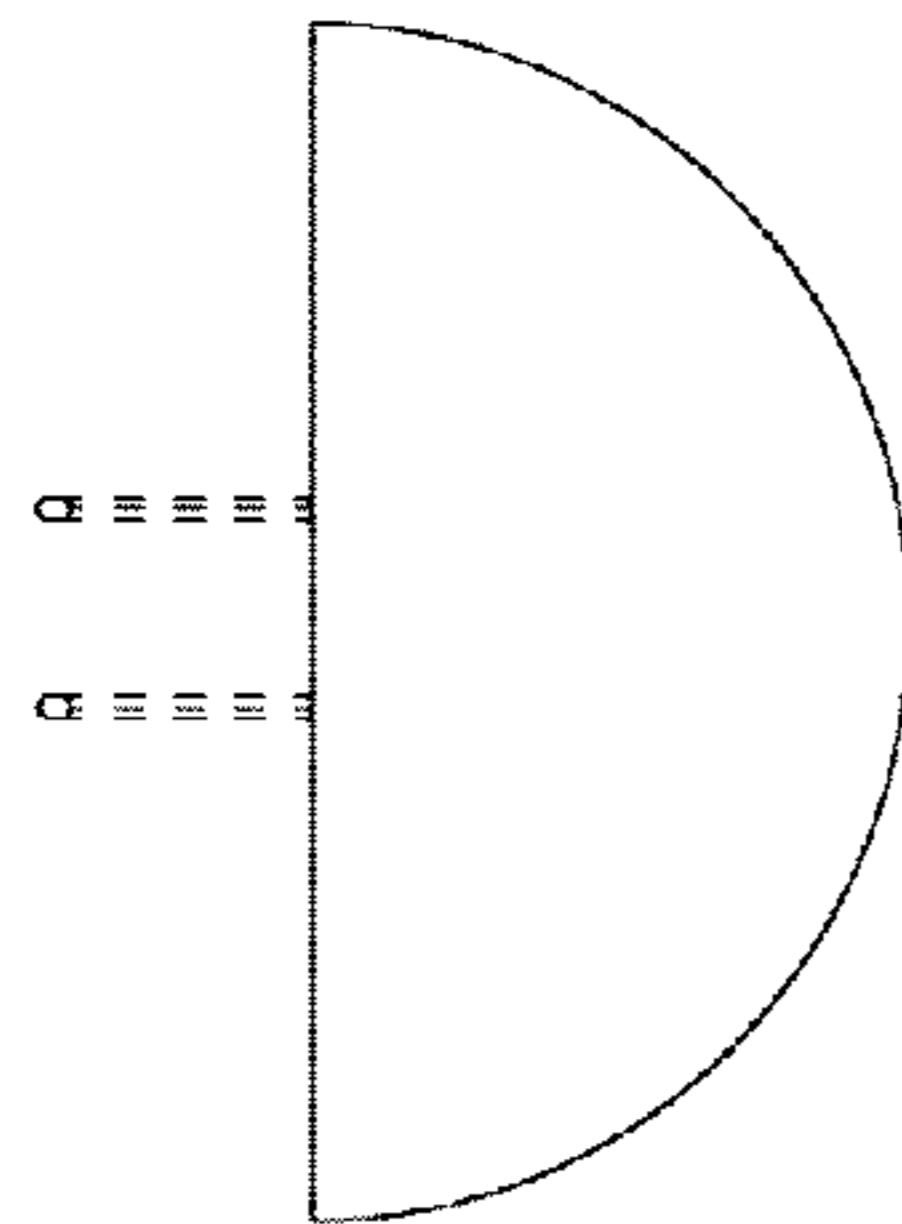

Figure 5

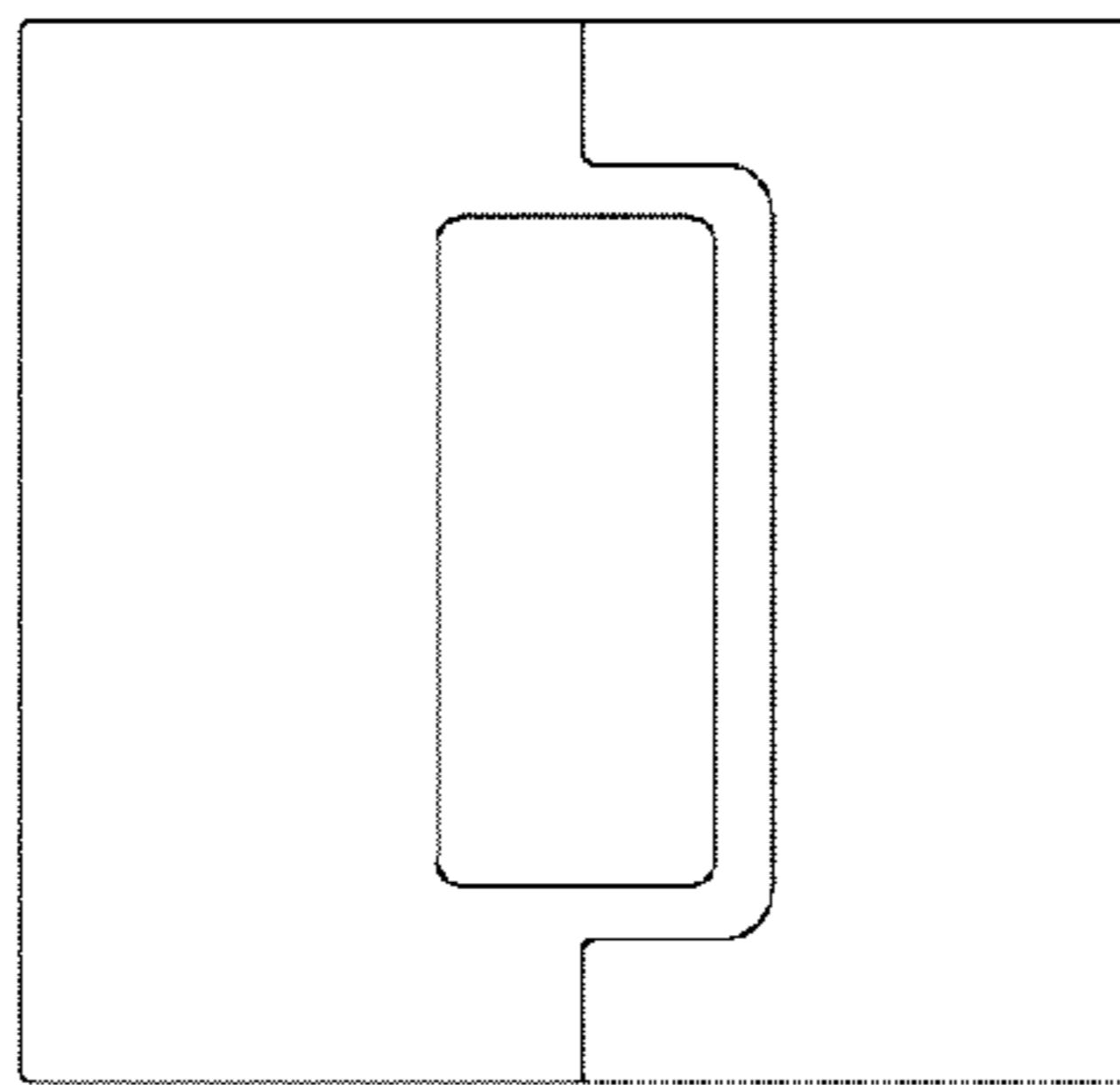

Figure 2

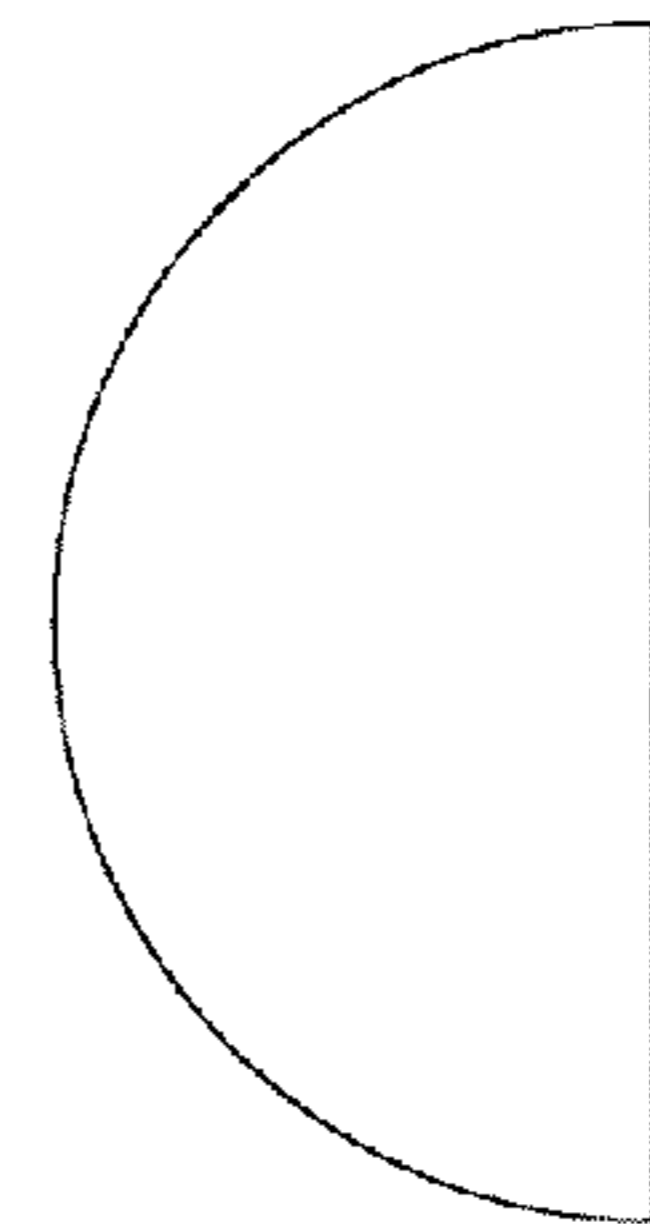

Figure 6

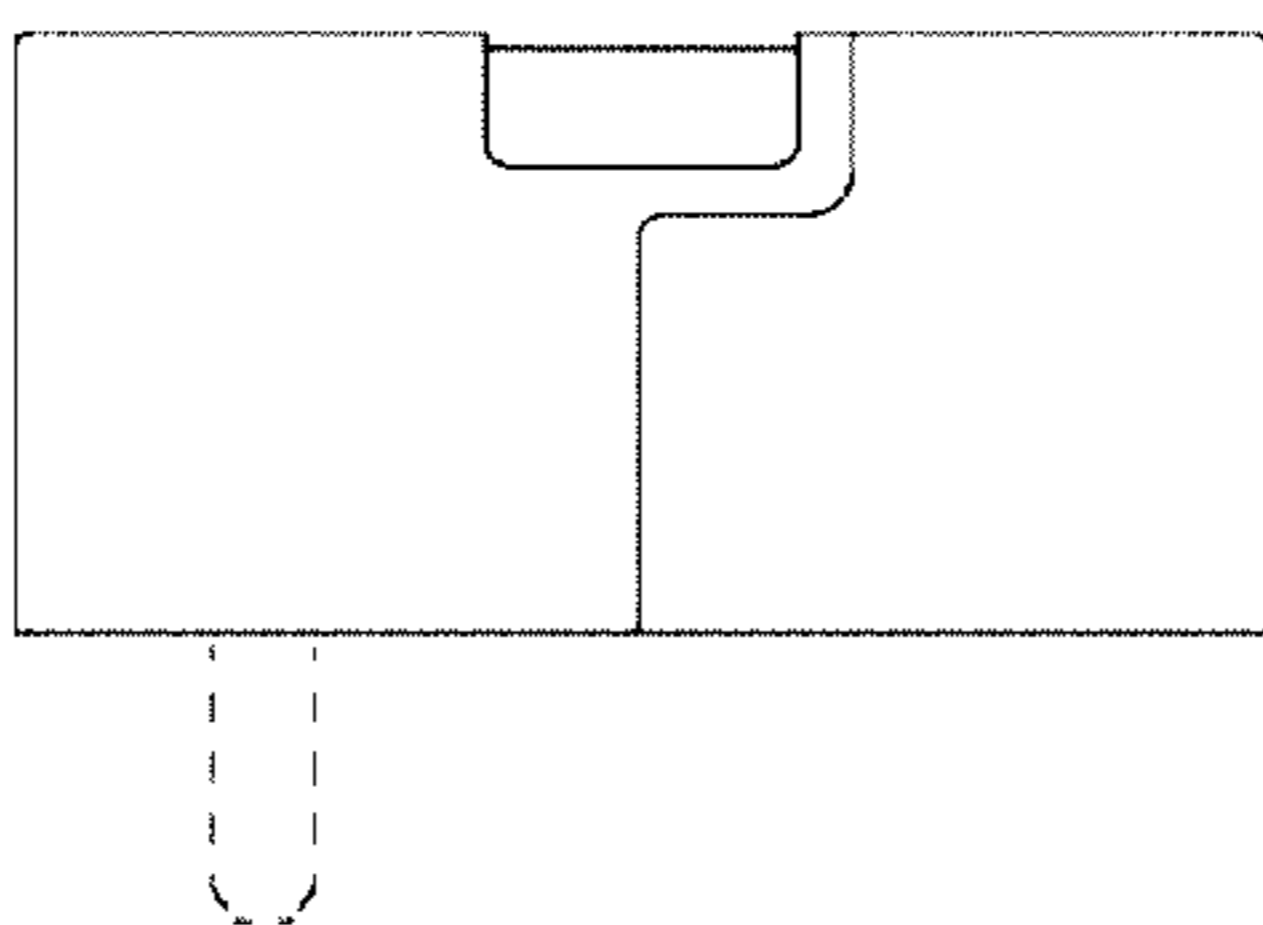

Figure 1