



US00D772385S

(12) **United States Design Patent**
Kim et al.

(10) **Patent No.:** **US D772,385 S**

(45) **Date of Patent:** **** Nov. 22, 2016**

(54) **AIR CONDITIONER**

(71) Applicant: **Samsung Electronics Co., Ltd.**,
Suwon-si (KR)

(72) Inventors: **Dae-Joung Kim**, Seoul (KR);
Tae-Kyung Huh, Seoul (KR); **Joo-Hee**
Ryu, Goyang-si (KR)

(73) Assignee: **Samsung Electronics Co., Ltd.**,
Suwon-si (KR)

(**) Term: **14 Years**

(21) Appl. No.: **29/523,482**

(22) Filed: **Apr. 10, 2015**

(51) **LOC (10) Cl.** **23-04**

(52) **U.S. Cl.**

USPC **D23/351**

(58) **Field of Classification Search**

USPC D23/314, 317, 324, 325, 328, 329, 330,
D23/332, 333, 335, 341, 342, 351, 353, 354,
D23/355, 356, 357, 359, 364, 365, 366, 370,
D23/385, 386, 388, 393, 499

CPC F24F 1/00; F24F 1/02; F24F 1/08;
F24F 1/42; F24F 1/46; F24F 1/60; F24F
1/0003; F24F 1/007; F24F 1/0011; F24F
3/044; F24F 3/048; F24F 3/16; F24F 7/00;
F24F 7/04; F24F 12/001; F24F 12/006;
F24F 13/20

See application file for complete search history.

(56) **References Cited**

U.S. PATENT DOCUMENTS

D368,305 S * 3/1996 Shigenari D23/351
D402,020 S * 12/1998 Aihara D23/351
D451,586 S * 12/2001 Oya D23/351
D581,504 S * 11/2008 Nakamura D23/351

D584,806 S * 1/2009 Oh D23/351
D593,665 S * 6/2009 Chouji D23/351
D605,270 S * 12/2009 Vibrans D23/351
D613,842 S * 4/2010 Yamashita D23/351
D624,168 S * 9/2010 Aketa D23/351
D670,799 S * 11/2012 Yamana D23/351
D674,068 S * 1/2013 Baek D23/351
D701,295 S * 3/2014 Chouji D23/351
2008/0311841 A1 * 12/2008 Taslim F24F 1/0011
454/275

* cited by examiner

Primary Examiner — Susan E Krakower

Assistant Examiner — Lisa A Grabenstetter

(74) *Attorney, Agent, or Firm* — NSIP Law

(57) **CLAIM**

The ornamental design for an air conditioner, as shown and described.

DESCRIPTION

FIG. 1 is a front perspective view of an air conditioner showing our new design;

FIG. 2 is a front view thereof;

FIG. 3 is a rear view thereof;

FIG. 4 is a left-side view thereof;

FIG. 5 is a right-side view thereof;

FIG. 6 is a top plan view thereof;

FIG. 7 is a bottom plan view thereof;

FIG. 8 is a partially enlarged front view, taken from FIG. 2; and,

FIG. 9 is a partially enlarged bottom view, taken from FIG. 7.

The broken lines in the figures show portions of the air conditioner which form no part of the claimed design.

The dot-dash broken line circles in FIGS. 2, 7, 8 and 9 are included to show enlarged views only and form no part of the claimed design.

1 Claim, 7 Drawing Sheets

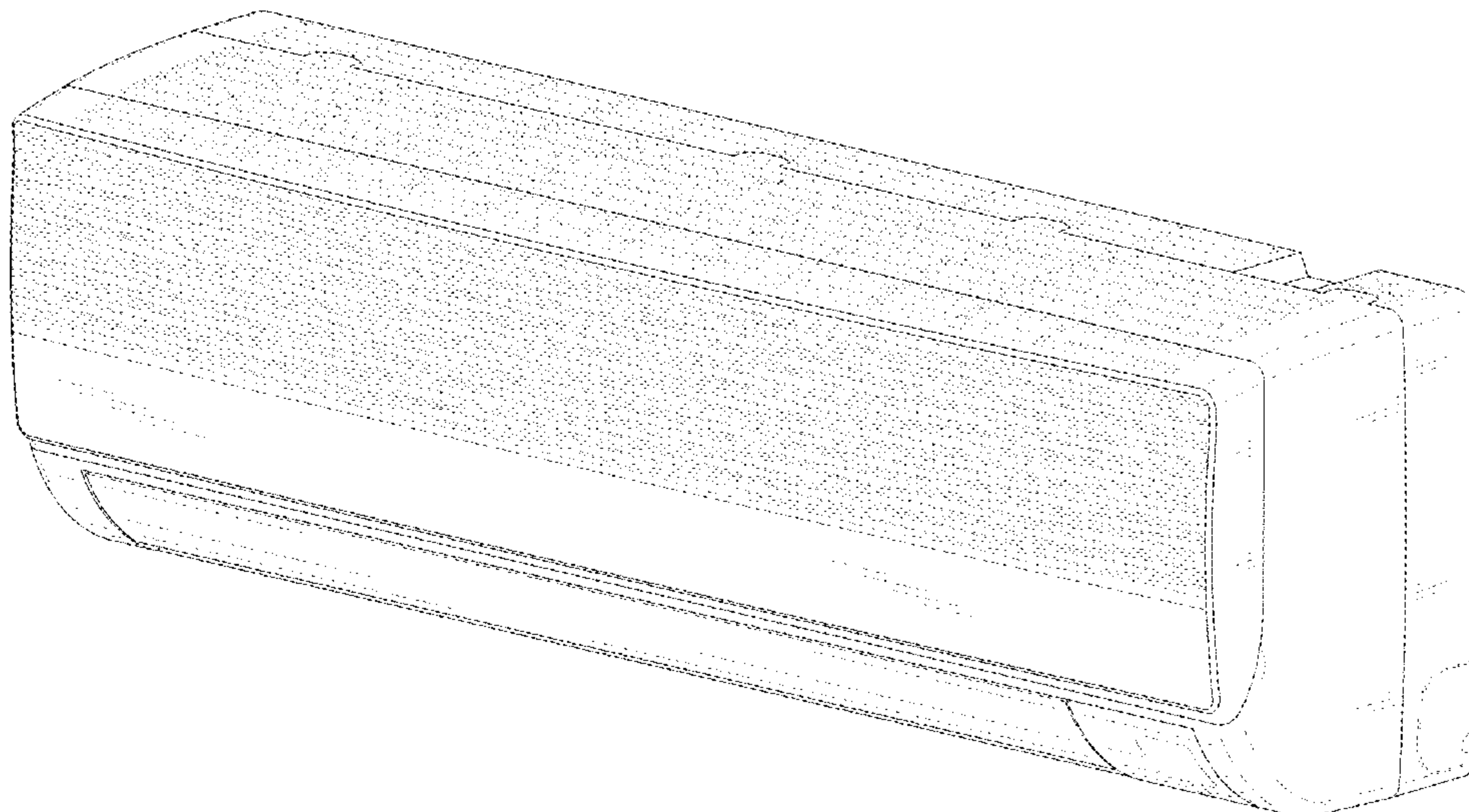

FIG. 1

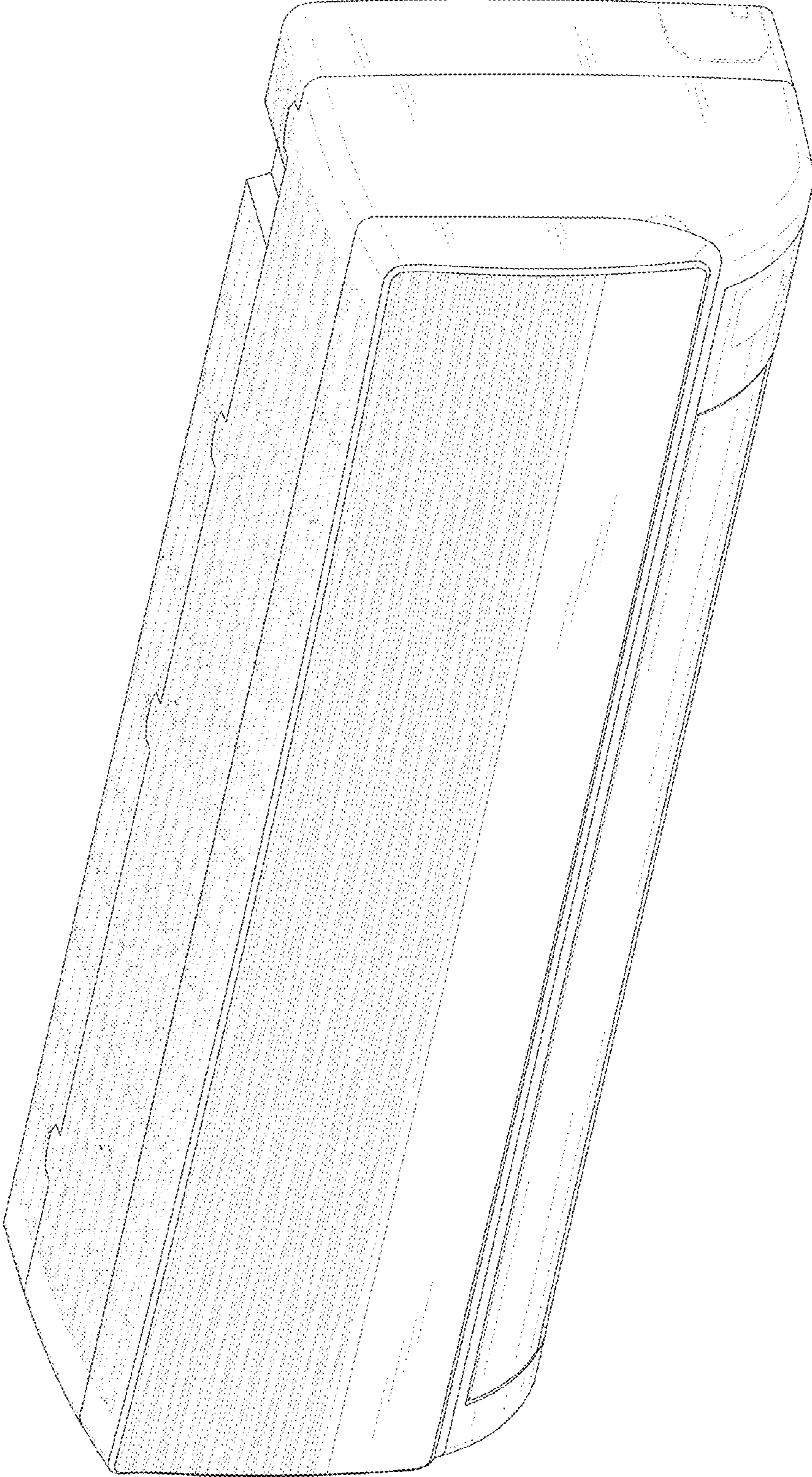

FIG. 2

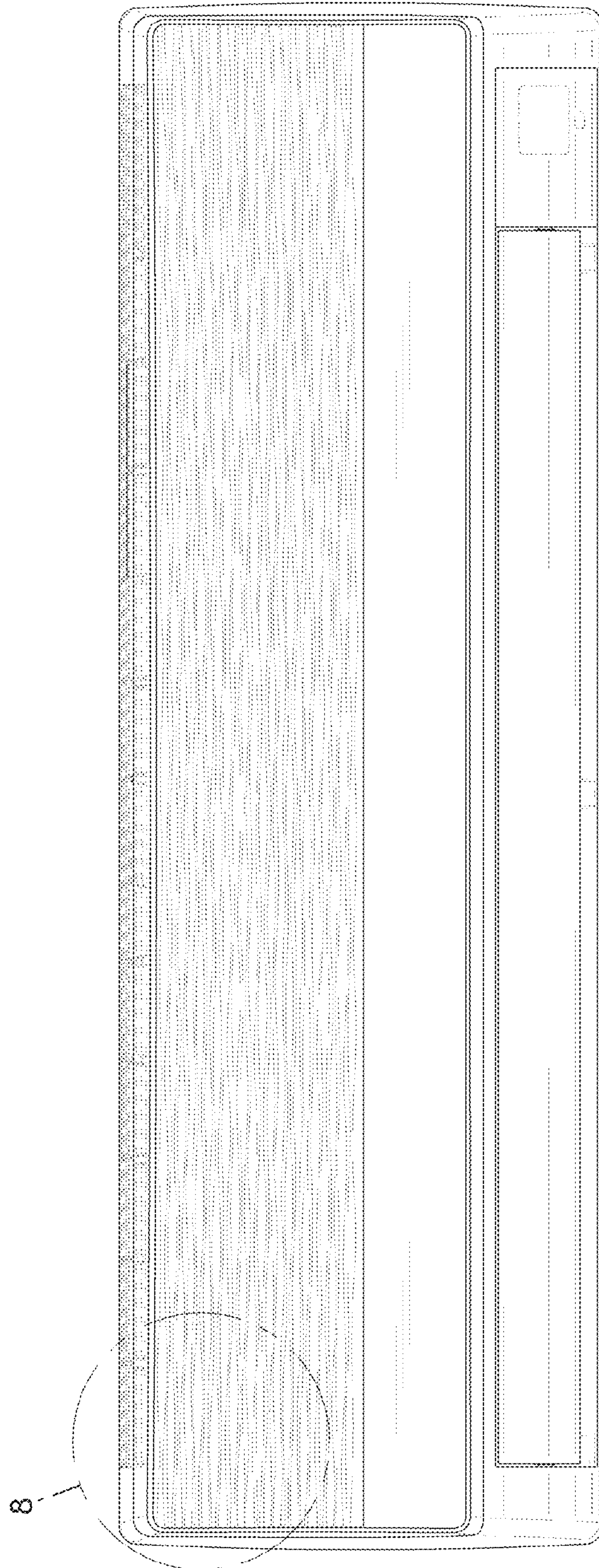

FIG. 3

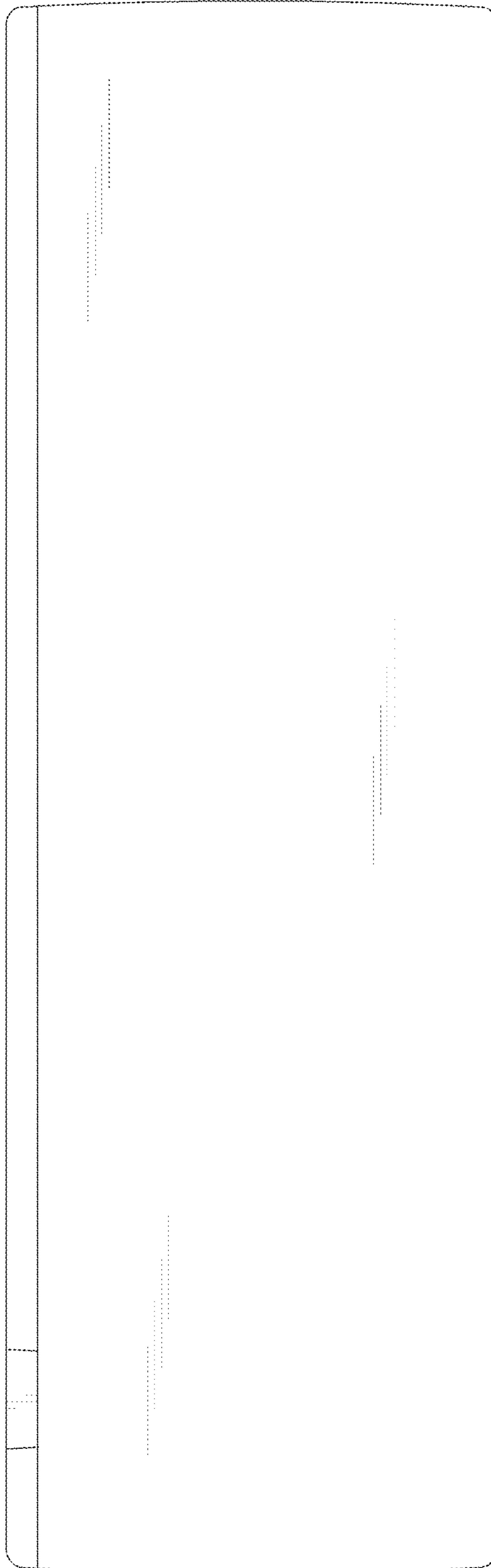

FIG. 5

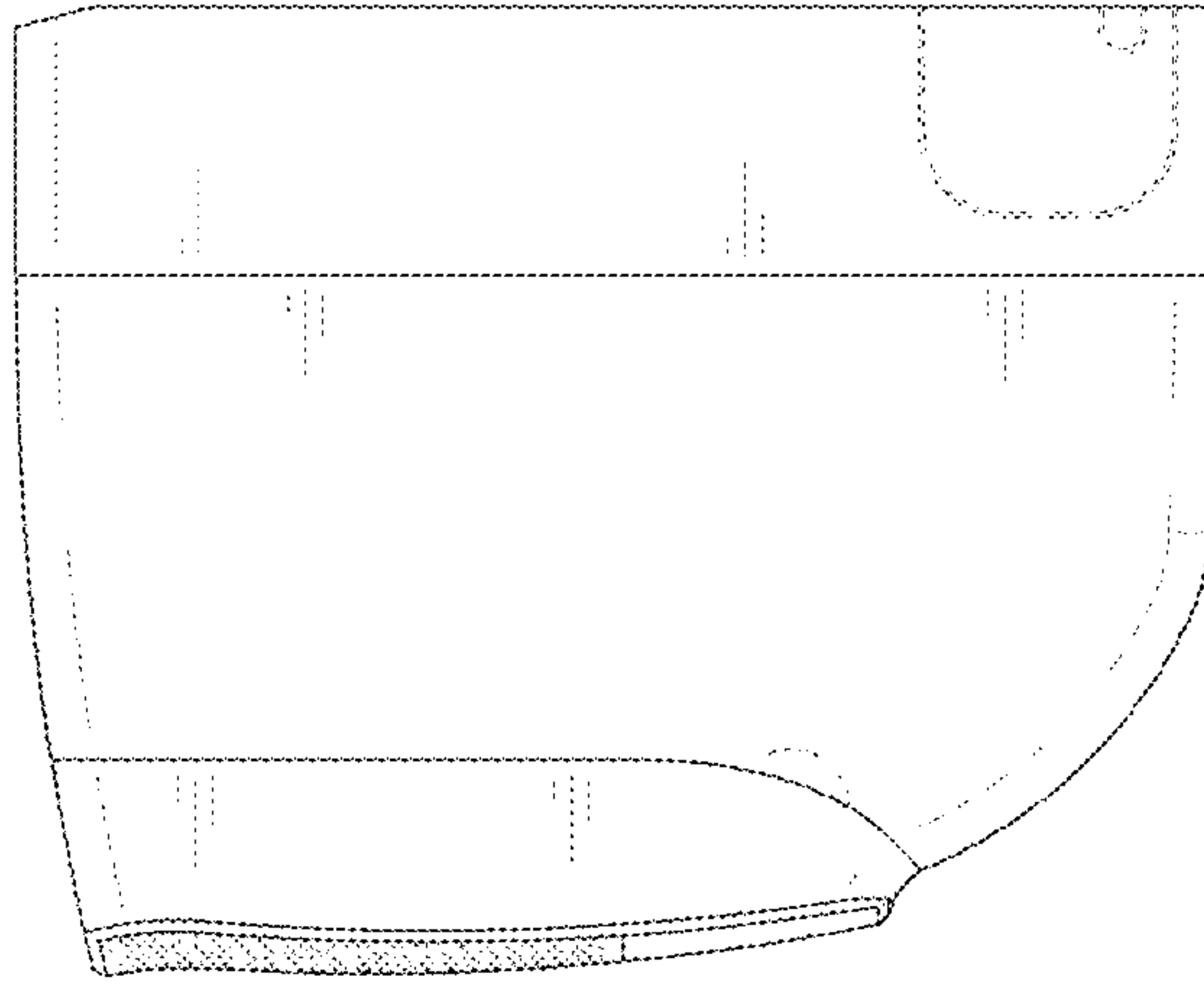

FIG. 4

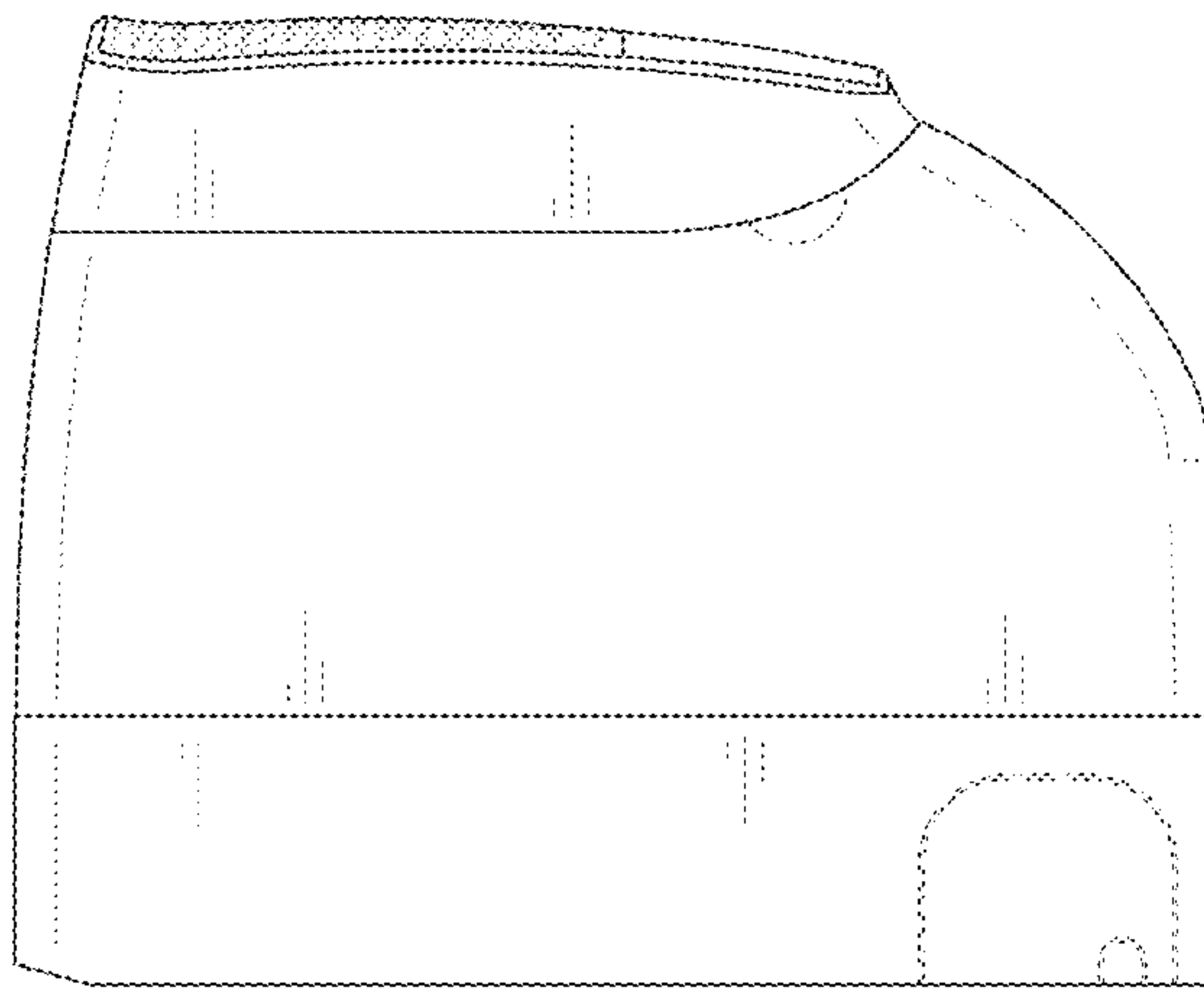

FIG. 6

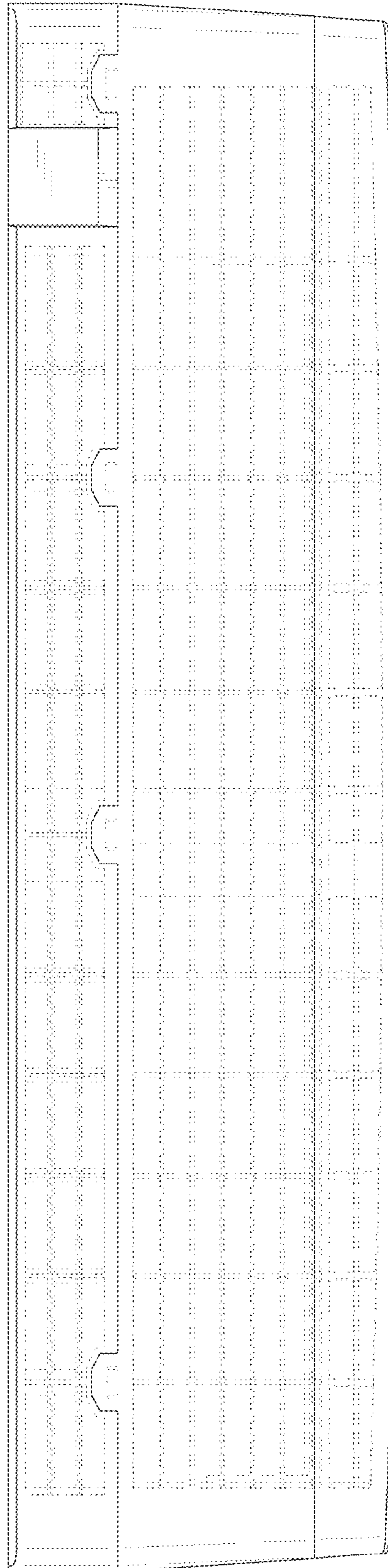

FIG. 7

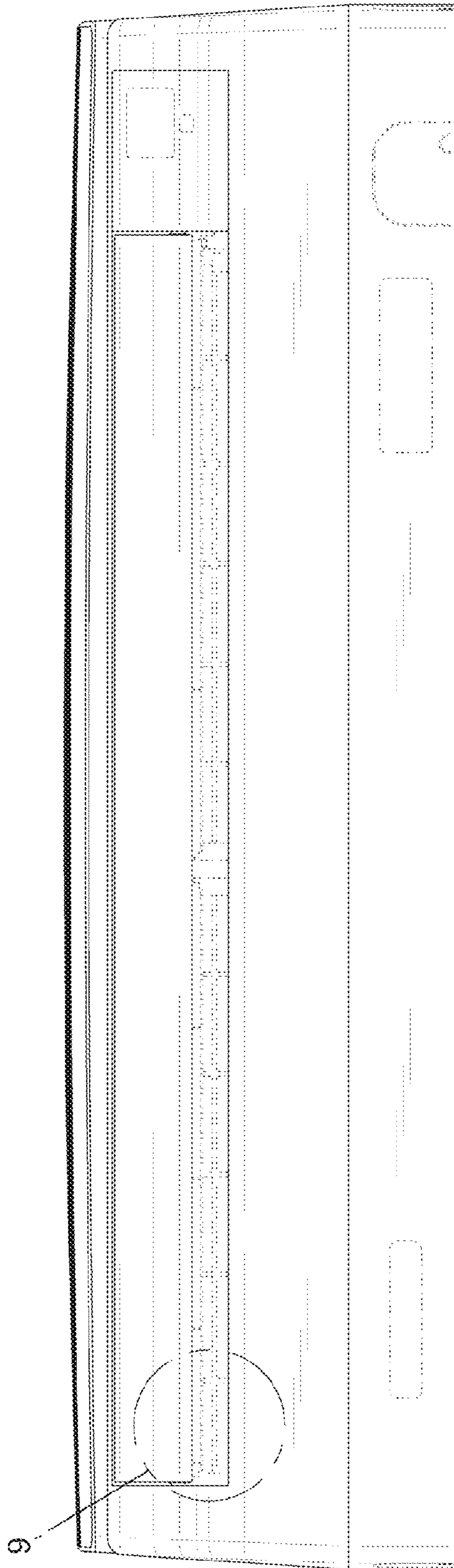

FIG. 9

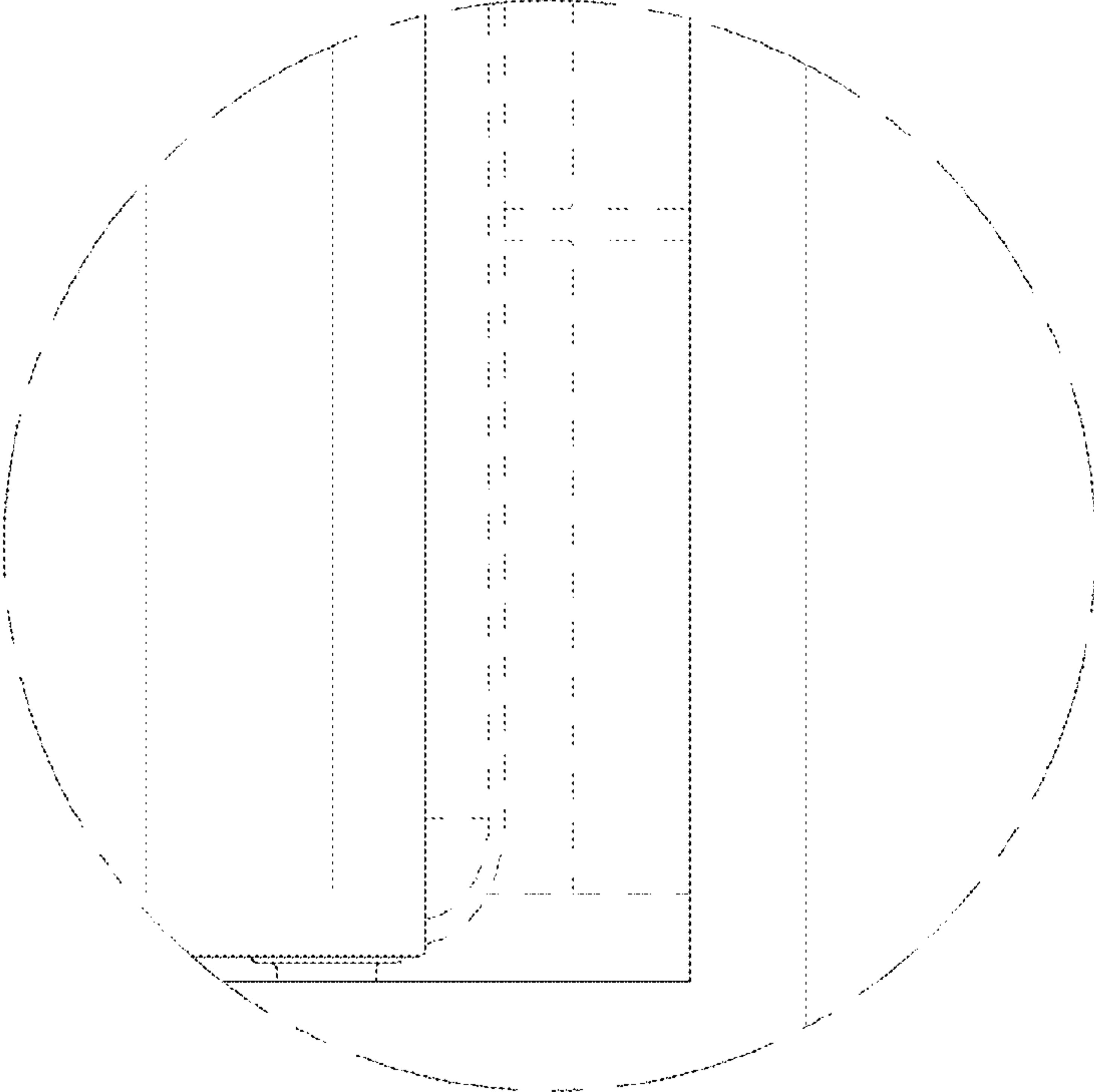

FIG. 8

