



US00D772304S

(12) **United States Design Patent** (10) **Patent No.:** **US D772,304 S**
Rondinella et al. (45) **Date of Patent:** **** Nov. 22, 2016**

(54) **SAND PLUNGER**
(71) Applicants: **Noberto Rondinella**, West Haven, CT
(US); **Michelle Rondinella**,
Windermere, FL (US)
(72) Inventors: **Noberto Rondinella**, West Haven, CT
(US); **Michelle Rondinella**,
Windermere, FL (US)

D297,847 S * 9/1988 Perkin D15/21
D308,211 S * 5/1990 Magnera D15/21
D312,464 S * 11/1990 Peterson D15/11
D313,025 S * 12/1990 East D15/21
5,222,564 A * 6/1993 Bonca E21B 7/027
173/189
5,245,878 A 9/1993 Underwood
5,487,434 A * 1/1996 Obermeier B23B 51/02
175/323
5,493,977 A * 2/1996 Maisch A01C 5/02
111/90

(**) Term: **15 Years**

(Continued)

(21) Appl. No.: **29/540,412**

FOREIGN PATENT DOCUMENTS

(22) Filed: **Sep. 24, 2015**

ES 2178907 1/2003

(51) **LOC (10) Cl.** **15-07**

Primary Examiner — Ian Simmons

(52) **U.S. Cl.**

Assistant Examiner — Khawaja Anwar

USPC **D15/21**

(74) *Attorney, Agent, or Firm* — Wiggin and Dana LLP;
Gregory S. Rosenblatt

(58) **Field of Classification Search**

USPC D15/10, 11, 13, 20, 21, 28, 199

CPC E21B 10/26; E21B 10/43; E21B 7/28;

E21B 10/00; E21B 10/36; E21B 4/14;

E21B 10/55; E21B 10/58; E21B 10/32;

E21B 10/42; E21B 10/322; E21B 10/38;

E21B 10/44; E21B 10/62; E21B 17/076;

E21B 1/00; E21B 25/00; E21B 41/02;

E21B 4/02; E21B 7/00; E21B 7/04; E21B

7/064; E21B 7/26; E21B 10/02; E21B 10/04;

E21B 10/10; E21B 10/14; E21B 10/22;

E21B 10/24; E21B 10/25; E21B 10/28;

E21B 10/30; E21B 10/325; E21B 10/40;

E21B 10/445; E21B 10/52; E21B 17/14;

E21B 17/16; E21B 17/20; E21B 2010/563;

E21B 2034/007; E21B 21/12; E21B 21/16;

E21B 25/02; E21B 29/00; E21B 29/06;

E21B 31/107; E21B 31/1135; E21B 34/12;

E21B 37/02; E21B 3/00; E21B 41/00;

E21B 43/126

See application file for complete search history.

(57) **CLAIM**

The ornamental design of a sand plunger, as shown and described.

DESCRIPTION

FIG. 1 is a top perspective view of a sand plunger showing our new design, in a first configuration; FIG. 2 is a front elevation view thereof; FIG. 3 is a back elevation view thereof; FIG. 4 is a left elevation view thereof; FIG. 5 is a right elevation view thereof; FIG. 6 is a top plan view thereof; FIG. 7 is a bottom plan view thereof; FIG. 8 is a top perspective view of a sand plunger, in an alternate configuration; FIG. 9 is a front elevation view thereof; FIG. 10 is a top perspective view if FIG. 1, shown in a condition of use; and, FIG. 11 is a right side elevation view thereof, shown in another condition of use. Those features and environmental illustrations shown in broken lines are for illustrative purposes only and form no part of the claimed design.

(56) **References Cited**

U.S. PATENT DOCUMENTS

D58,691 S * 8/1921 Sortor D15/21
2,690,055 A 3/1951 Lundgren et al.

1 Claim, 4 Drawing Sheets

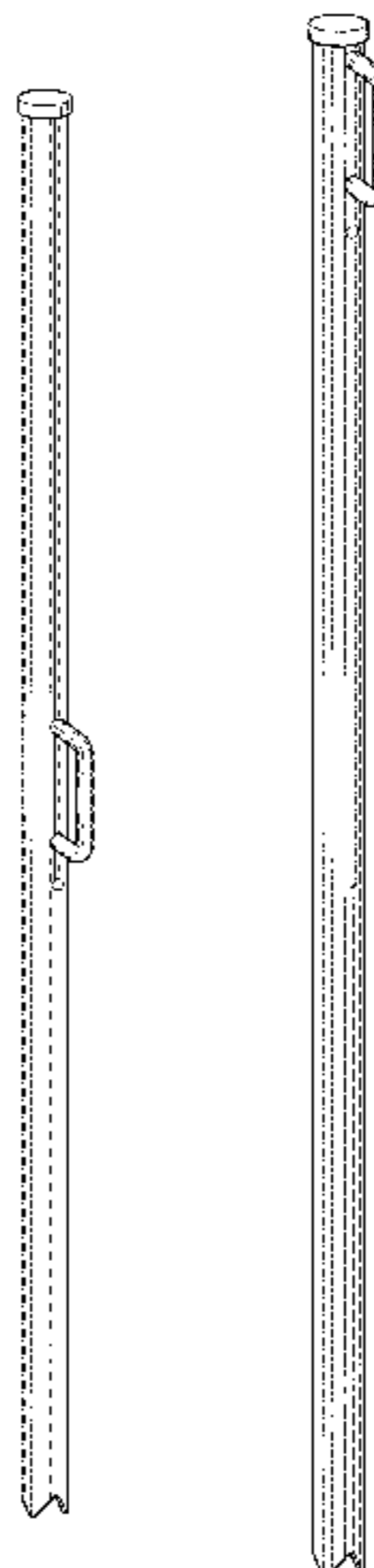

(56)

References Cited

U.S. PATENT DOCUMENTS
D371,797 S * 7/1996 Bruns D15/28
D512,076 S * 11/2005 Wuest 56/1
D512,077 S * 11/2005 Wuest D15/28
D557,290 S * 12/2007 Melegari D15/139
8,276,683 B1 * 10/2012 Roy B25D 1/16
173/126

8,459,374 B1 * 6/2013 Copping G01N 1/08
175/20
8,926,228 B2 * 1/2015 Stroyer E02D 5/36
175/323
8,955,612 B2 2/2015 O'Toole
D736,267 S * 8/2015 Parks D15/28
2012/0267131 A1 10/2012 de Oliveira

* cited by examiner

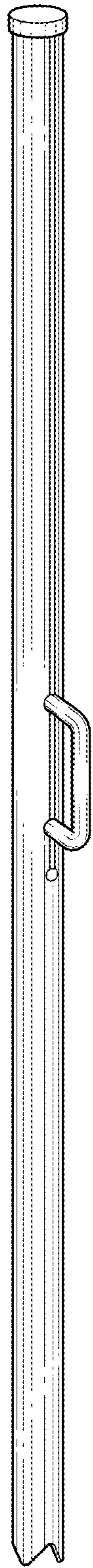

FIG. 1

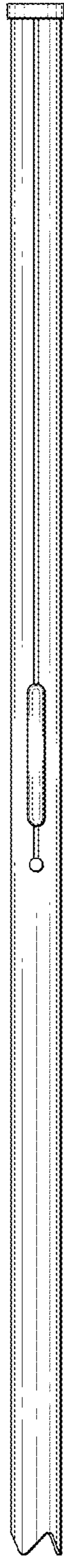

FIG. 2

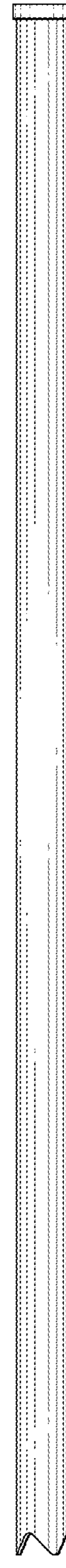

FIG. 3

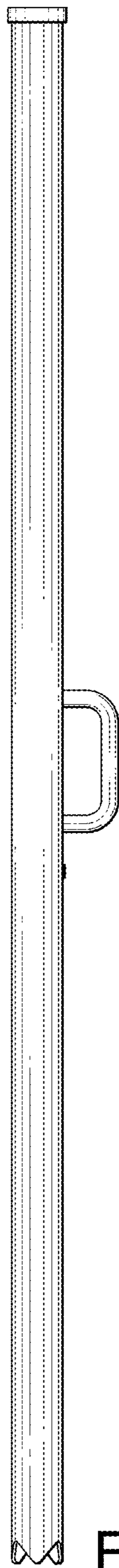

FIG. 4

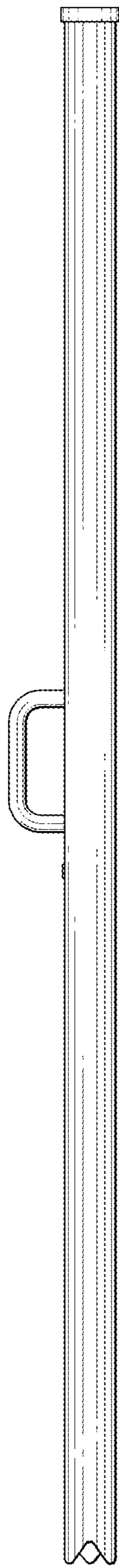

FIG. 5



FIG. 6

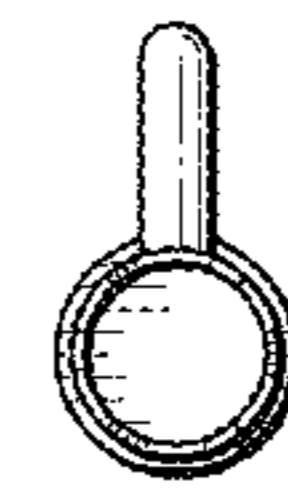

FIG. 7

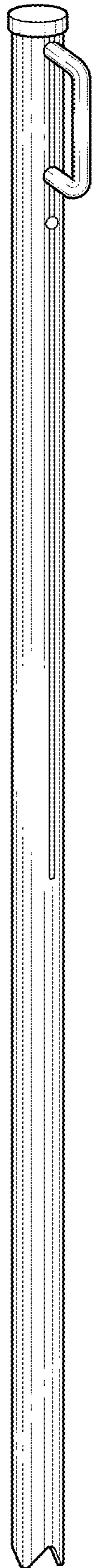

FIG. 8



FIG. 9

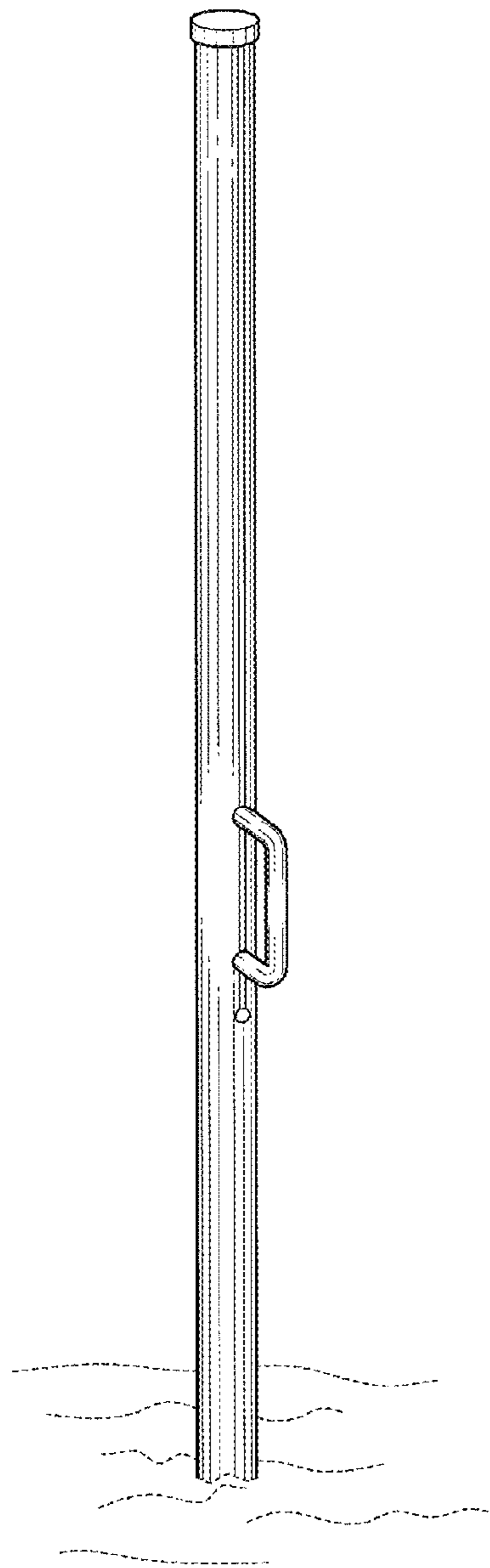

FIG. 10

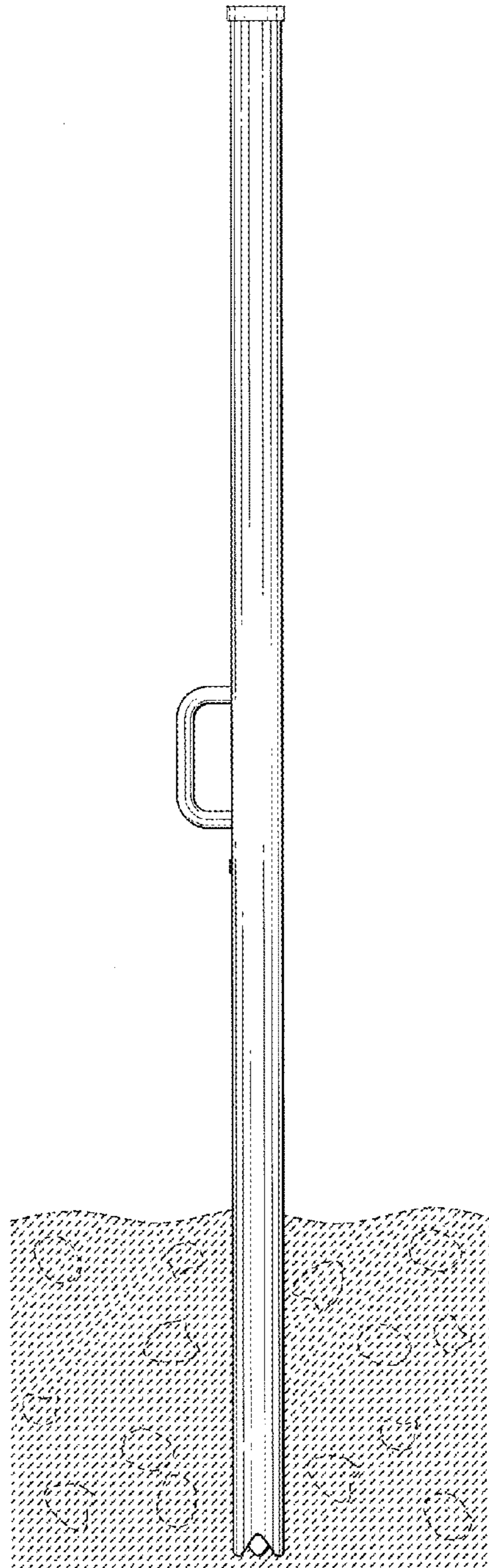

FIG. 11