



US00D772300S

(12) **United States Design Patent**
Okamoto et al.

(10) **Patent No.:** **US D772,300 S**

(45) **Date of Patent:** **** Nov. 22, 2016**

(54) **AUTOMOTIVE ENGINE COMPUTER UNIT COVER**

(71) Applicant: **DENSO CORPORATION**, Kariya, Aichi-pref. (JP)

(72) Inventors: **Akira Okamoto**, Nagoya (JP);
Masanori Tsunoo, Kasugai (JP)

(73) Assignee: **DENSO CORPORATION**, Kariya (JP)

(**) Term: **14 Years**

(21) Appl. No.: **29/510,995**

(22) Filed: **Dec. 5, 2014**

(30) **Foreign Application Priority Data**

Jun. 27, 2014 (JP) 2014-14168

(51) **LOC (10) Cl.** **15-01**

(52) **U.S. Cl.**
USPC **D15/5**

(58) **Field of Classification Search**
USPC D15/1-6; D24/224, 225, 226, 227, 228,
D24/229; D9/737, 424, 416, 425, 347, 761;
D7/553.1, 555; 361/752, 714, 730;
D13/184; 174/50, 521, 256, 533
CPC F02D 29/00; F02D 41/20; F02D 2400/18;
F02D 2400/21; F02D 2041/285; H01L
25/162; H05K 5/0091; H05K 5/0204; B60R
16/0239

See application file for complete search history.

(56) **References Cited**

U.S. PATENT DOCUMENTS

D196,884 S * 11/1963 Furlong D19/83
D200,815 S * 4/1965 Chard D24/229
D245,499 S * 8/1977 Andreas D13/112
D367,466 S * 2/1996 Uchiyama D13/147
D402,137 S * 12/1998 Blazeovich D6/682.4
D425,869 S * 5/2000 Yokomizo D13/147

6,118,075 A * 9/2000 Baker H04Q 1/06
174/100
6,570,088 B1 * 5/2003 Depp B60R 16/0238
174/50
D487,971 S * 4/2004 Bergeron D3/313
7,593,230 B2 * 9/2009 Abul-Haj F28F 3/02
361/702
D624,692 S * 9/2010 Mackin D26/142
D634,024 S * 3/2011 Karpiloff D24/224
D665,114 S * 8/2012 Werner D26/37
D667,845 S * 9/2012 Moysi D15/7

(Continued)

OTHER PUBLICATIONS

U.S. Appl. No. 29/510,993, filed Dec. 5, 2014, Okamoto et al.

(Continued)

Primary Examiner — T. Chase Nelson

Assistant Examiner — Ania Aman

(74) *Attorney, Agent, or Firm* — Posz Law Group, PLC

(57) **CLAIM**

The ornamental design for an automotive engine computer unit cover, as shown and described.

DESCRIPTION

FIG. 1 is a front view of an automotive engine computer unit cover, showing our new design;
FIG. 2 is a rear view of the unit cover shown in FIG. 1;
FIG. 3 is a top plan view of the unit cover shown in FIG. 1;
FIG. 4 is a bottom plan view of the unit cover shown in FIG. 1;
FIG. 5 is a left side view of the unit cover shown in FIG. 1;
FIG. 6 is a right side view of the unit cover shown in FIG. 1; and,
FIG. 7 is a perspective view of the unit cover shown in FIG. 1.

The article of the present design relates to an automotive engine computer unit cover. The parts shown by broken lines in the drawings form no part of the claimed design.

1 Claim, 3 Drawing Sheets

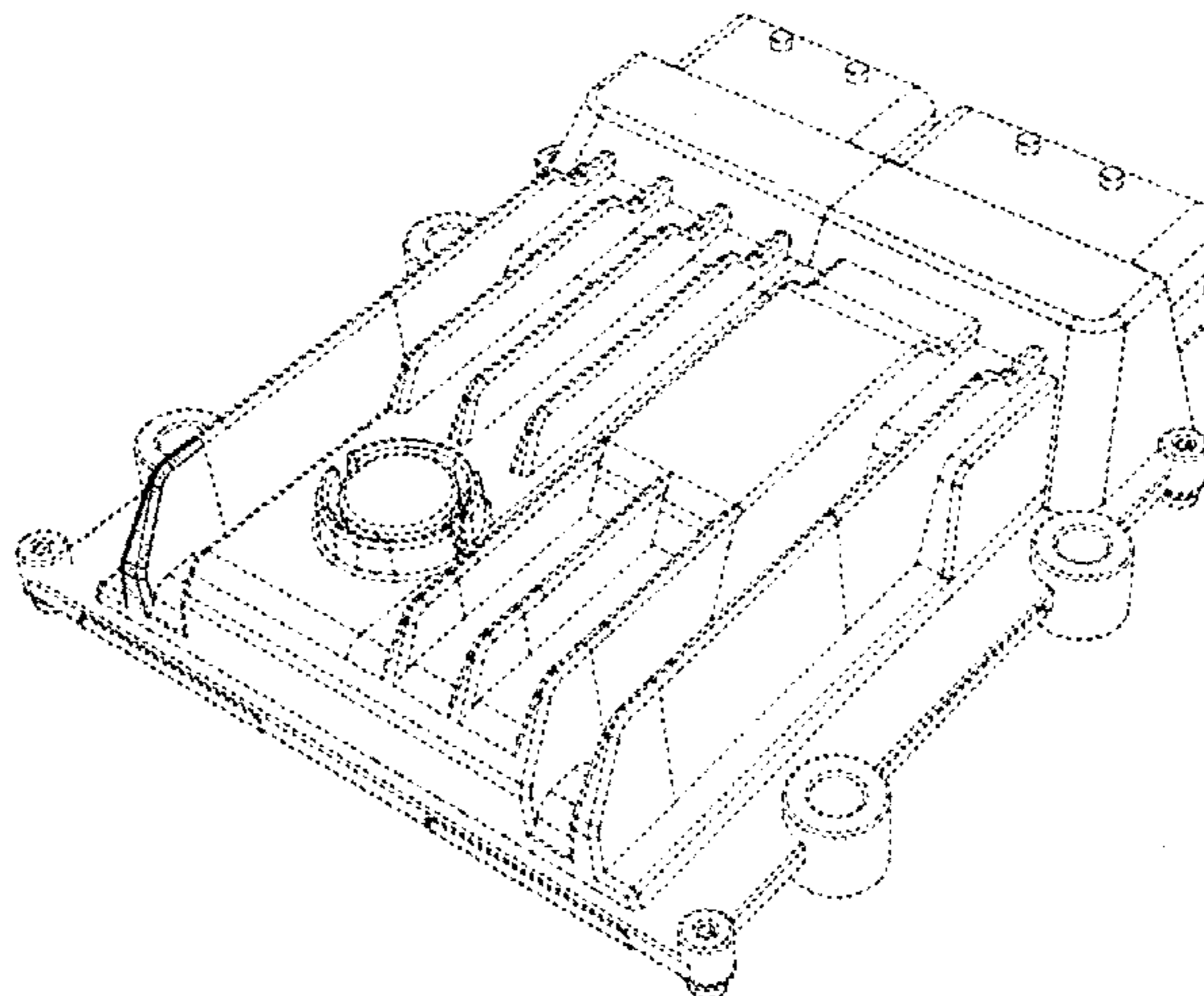

(56)

References Cited

2015/0109745 A1* 4/2015 Nagai H04H 60/04
361/752

U.S. PATENT DOCUMENTS

8,520,381 B2* 8/2013 Hobein H02M 7/003
361/679.54
D747,813 S * 1/2016 Onishi D24/224
2007/0002547 A1* 1/2007 Garmong H05K 9/0001
361/752

OTHER PUBLICATIONS

U.S. Appl. No. 29/510,996, filed Dec. 5, 2014, Okamoto et al.

* cited by examiner

FIG. 1

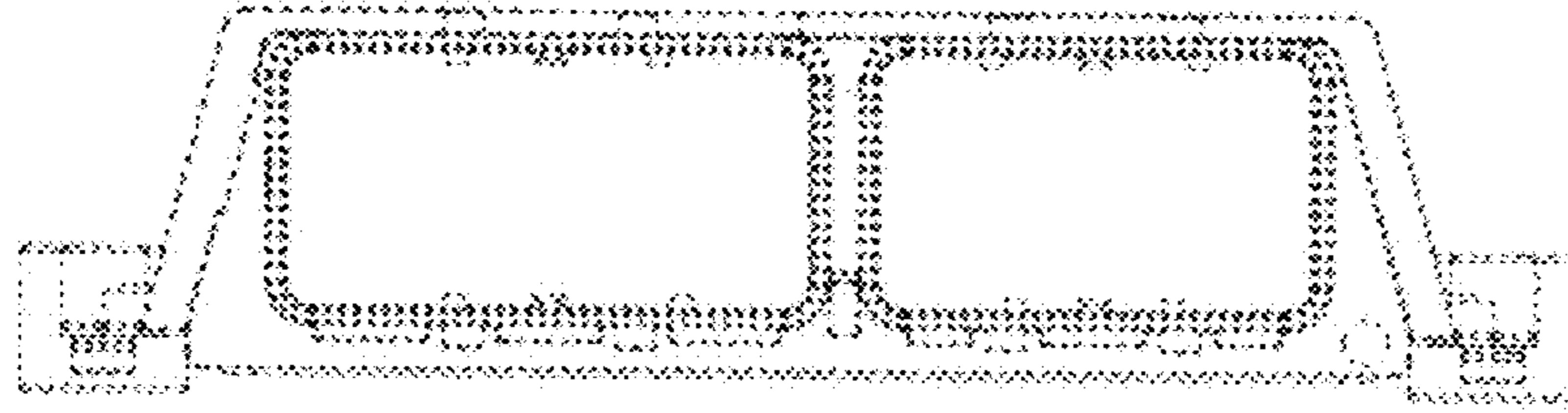

FIG. 2

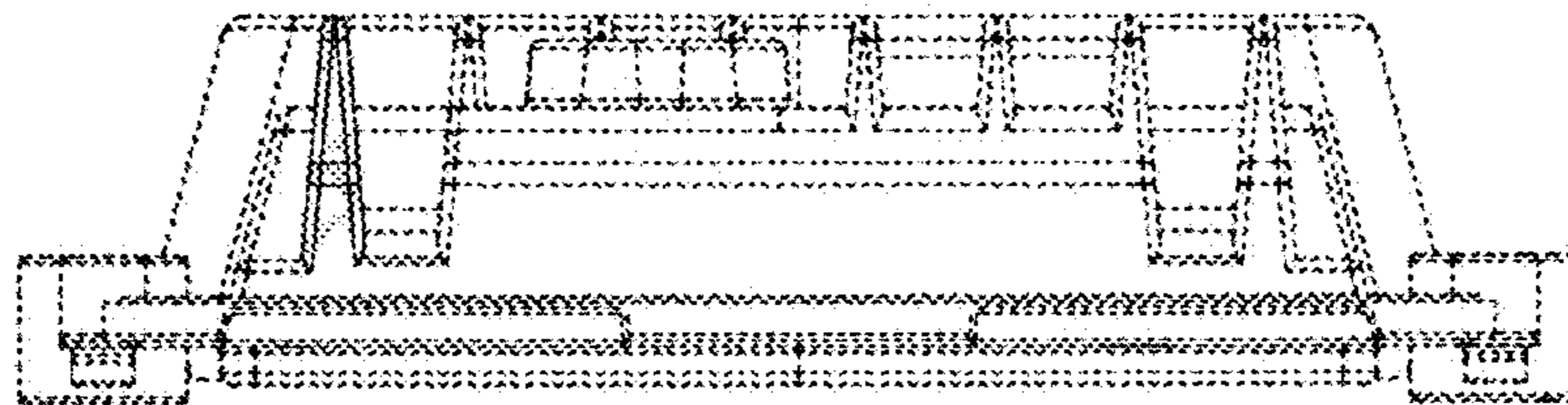

FIG. 3

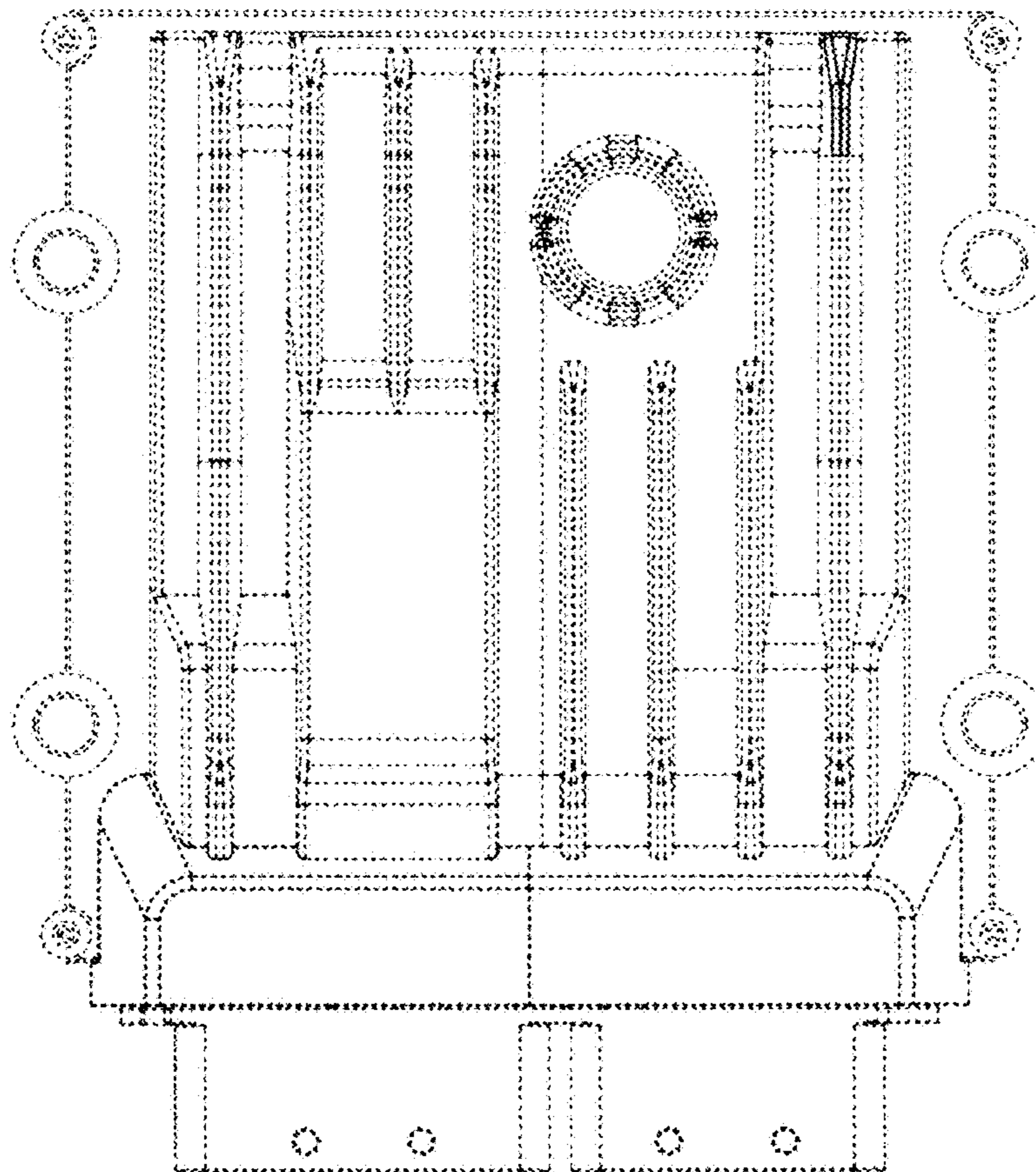

FIG. 4

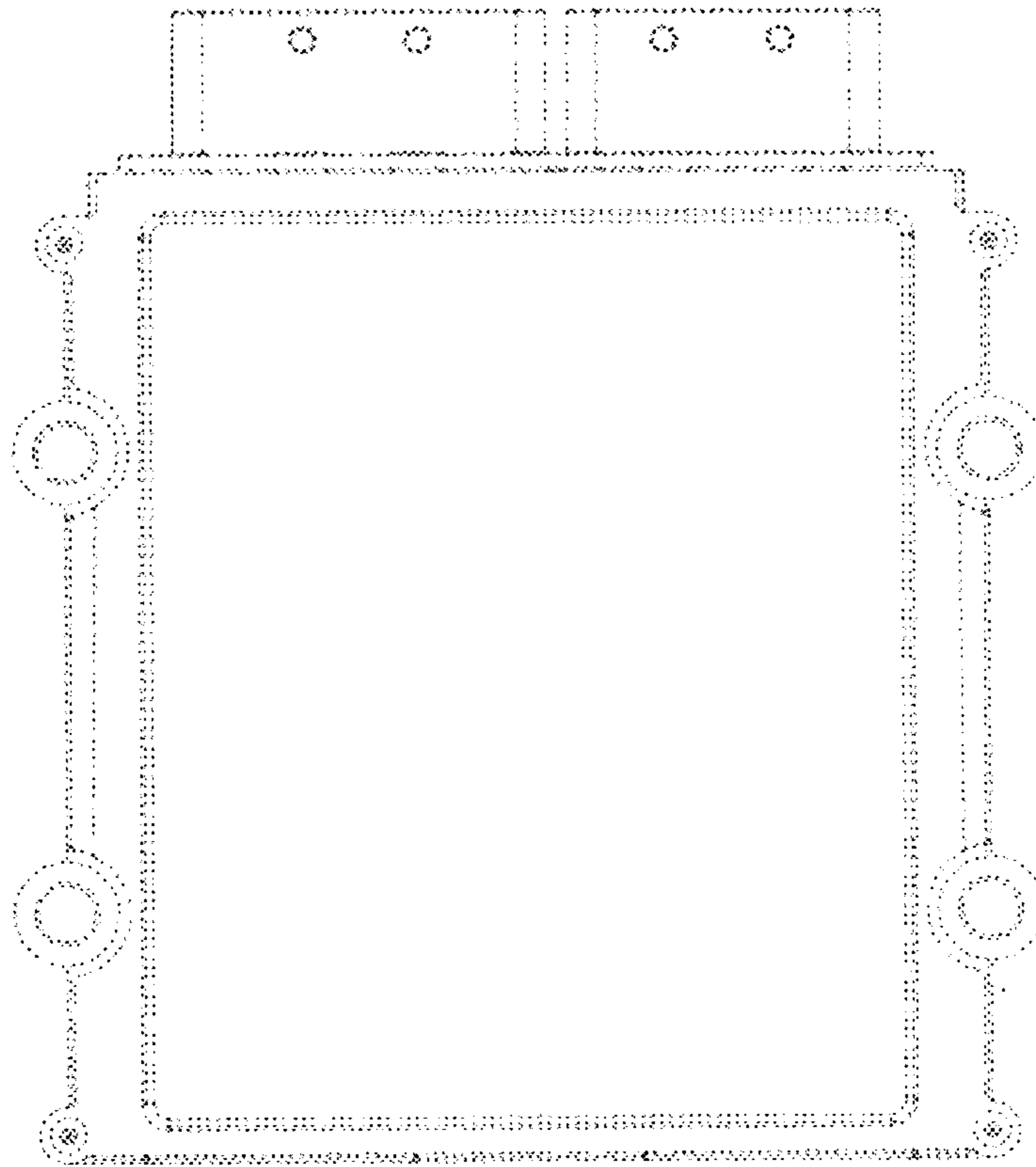

FIG. 5

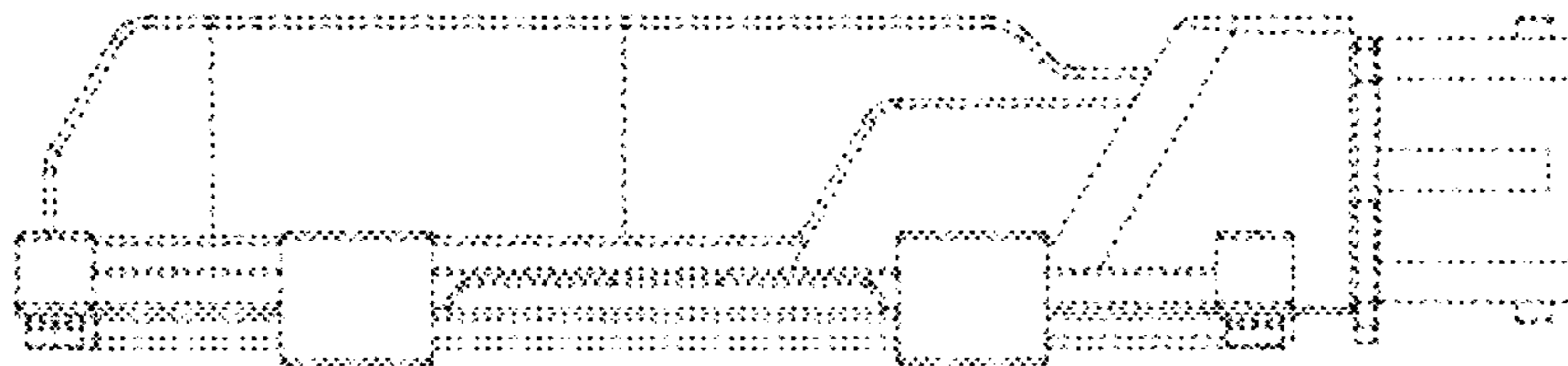

FIG. 6

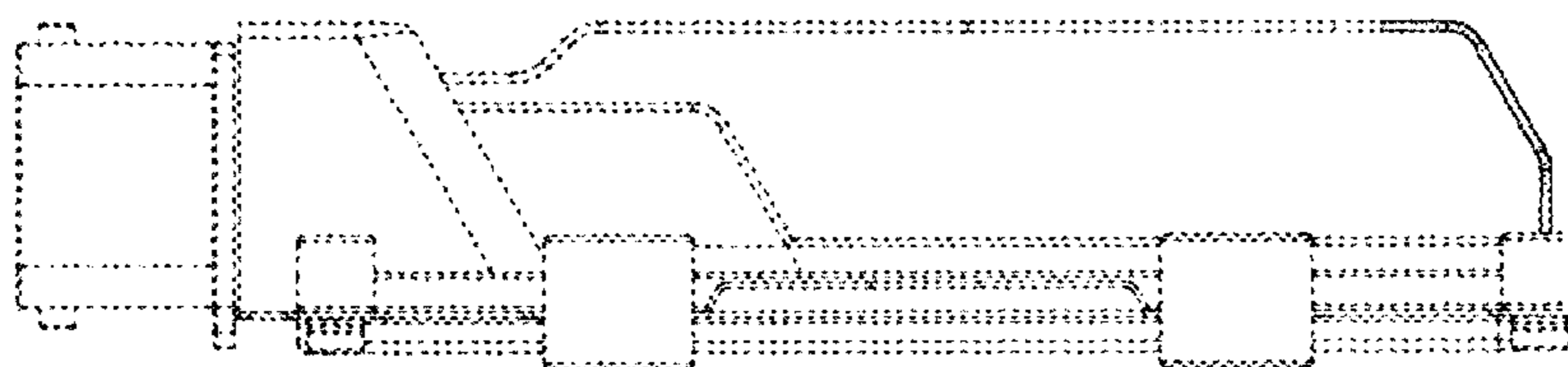

FIG. 7

