



US00D772277S

(12) **United States Design Patent** (10) **Patent No.:** **US D772,277 S**
Sakuma (45) **Date of Patent:** **** Nov. 22, 2016**

(54) **DIGITAL-CAMERA DISPLAY SCREEN WITH ANIMATED GRAPHICAL USER INTERFACE**

(71) Applicant: **FUJIFILM CORPORATION**, Tokyo (JP)

(72) Inventor: **Nanae Sakuma**, Tokyo (JP)

(73) Assignee: **FUJIFILM CORPORATION**, Tokyo (JP)

(**) Term: **14 Years**

(21) Appl. No.: **29/446,057**

(22) Filed: **Feb. 20, 2013**

(30) **Foreign Application Priority Data**

Aug. 22, 2012 (JP) 2012-020050

(51) **LOC (10) Cl.** **14-04**

(52) **U.S. Cl.**
USPC **D14/487**

(58) **Field of Classification Search**
USPC D14/485–495; 715/700–867, 961–978
CPC G06F 3/04847; G06F 17/211; G06F 3/0481; G06F 9/446; G06F 9/4443; G09B 21/003; G09B 21/007
See application file for complete search history.

(56) **References Cited**

U.S. PATENT DOCUMENTS

D454,574	S *	3/2002	Wasko et al.	D14/487
D491,955	S *	6/2004	Ording et al.	D14/487
D539,809	S *	4/2007	Totten et al.	D14/487
D546,341	S *	7/2007	Viegers et al.	D14/487
D596,646	S *	7/2009	Wani	D14/488
D604,308	S *	11/2009	Takano	D14/486
D614,197	S *	4/2010	Casagrande	D14/487
8,112,718	B2 *	2/2012	Nezu et al.	715/810
8,405,653	B1 *	3/2013	Davidson	345/419
8,644,968	B2 *	2/2014	Kitahara et al.	700/94
2007/0201851	A1 *	8/2007	Misawa et al.	396/125
2007/0291334	A1 *	12/2007	Nakanishi	358/509

2009/0213086	A1 *	8/2009	Chae et al.	345/173
2010/0050075	A1 *	2/2010	Thorson et al.	715/702
2010/0060586	A1 *	3/2010	Pisula et al.	345/169
2010/0125791	A1 *	5/2010	Katis et al.	715/716
2010/0305726	A1 *	12/2010	Lu et al.	700/94
2012/0036435	A1 *	2/2012	Yang et al.	715/702
2012/0060088	A1 *	3/2012	Hill et al.	715/702
2012/0081364	A1 *	4/2012	Yamaji et al.	345/419
2012/0173978	A1 *	7/2012	Lee et al.	715/716
2014/0033100	A1 *	1/2014	Noda et al.	715/769
2015/0109498	A1 *	4/2015	Aoki et al.	348/280

* cited by examiner

Primary Examiner — Ian Simmons

Assistant Examiner — Shannon Morgan

(74) *Attorney, Agent, or Firm* — Jean C. Edwards, Esq.;
Edwards Neils LLC

(57) **CLAIM**

The ornamental design for a digital-camera display screen with animated graphical user interface, as shown and described.

DESCRIPTION

FIG. 1 is a first image of a digital-camera display screen with animated graphical user interface showing my new design; FIG. 2 is a second image thereof; FIG. 3 is a third image thereof; FIG. 4 is a front view thereof; FIG. 5 is a rear view thereof which shows the first image of FIG. 1; FIG. 6 is a left side view thereof; FIG. 7 is a right side view thereof; FIG. 8 is a top plan view thereof; and, FIG. 9 is a bottom view thereof.

The appearance of image transitions sequentially between the images shown in FIGS. 1 through 3.

The process or period in which one image transitions to another image forms no part of the claimed design.

The broken lines shown in the figures represent portions of the digital-camera display screen with animated graphical user interface that form no part of the claimed design.

1 Claim, 8 Drawing Sheets

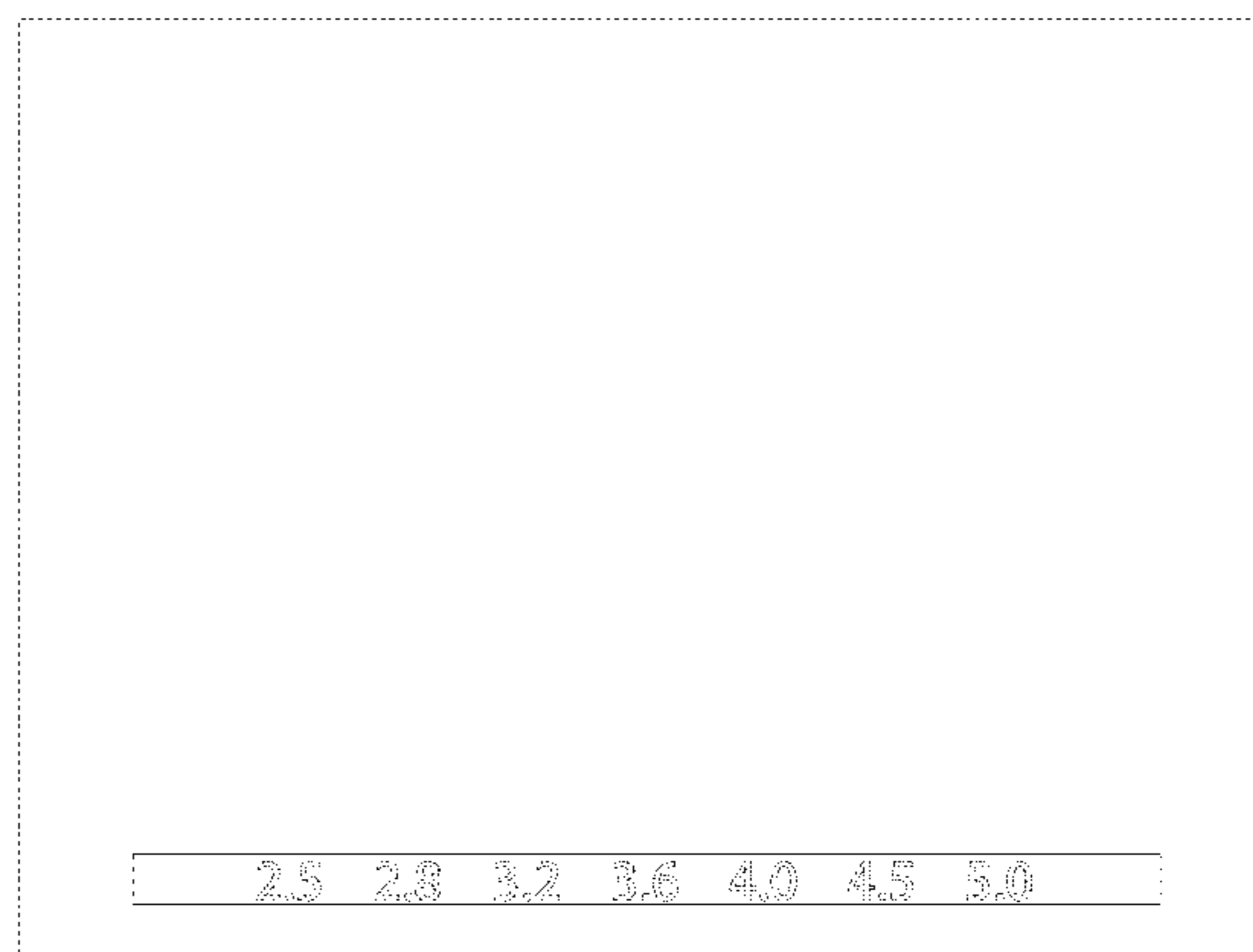

Fig. 1

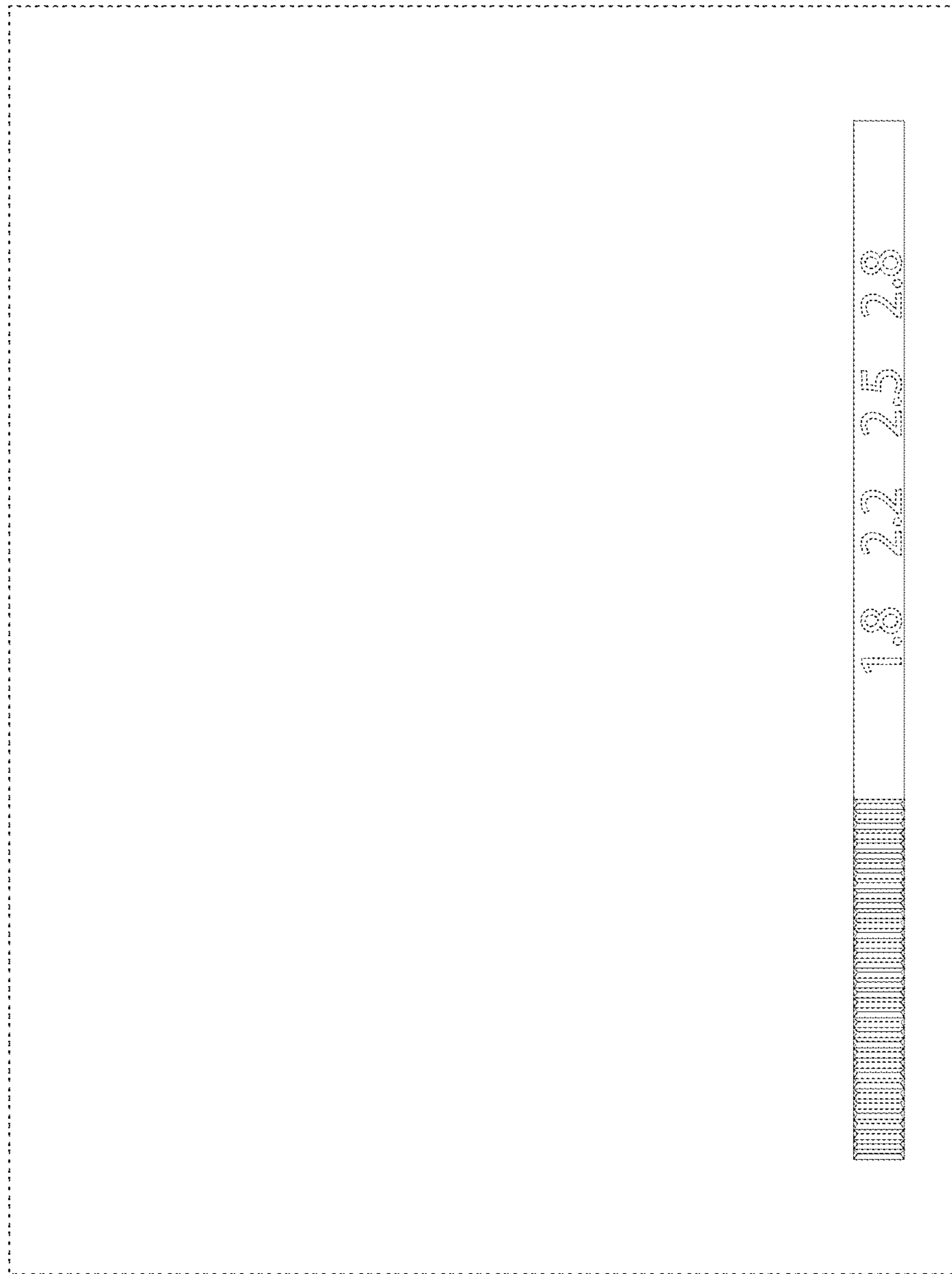

Fig. 2

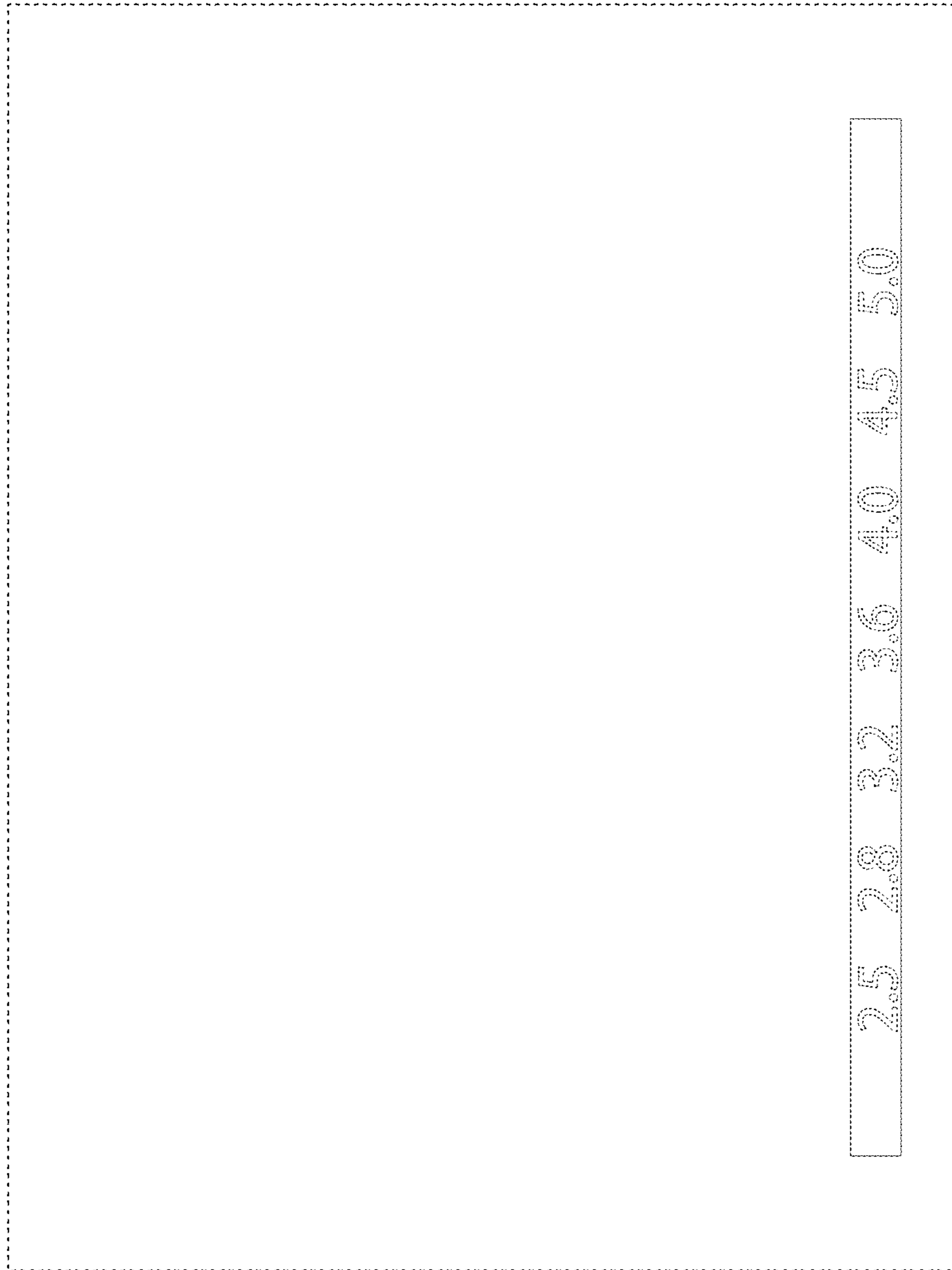

Fig. 3

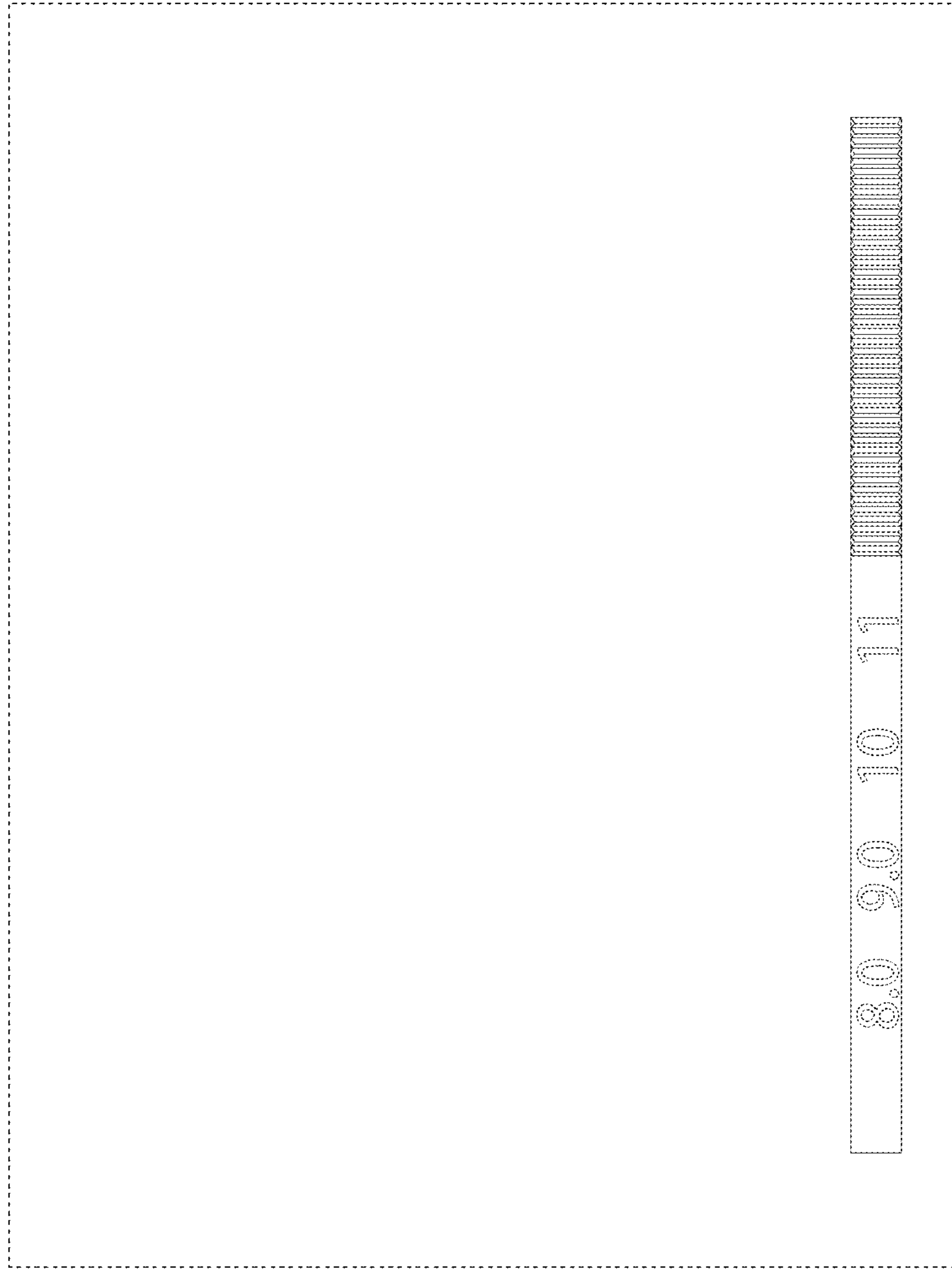

Fig. 4

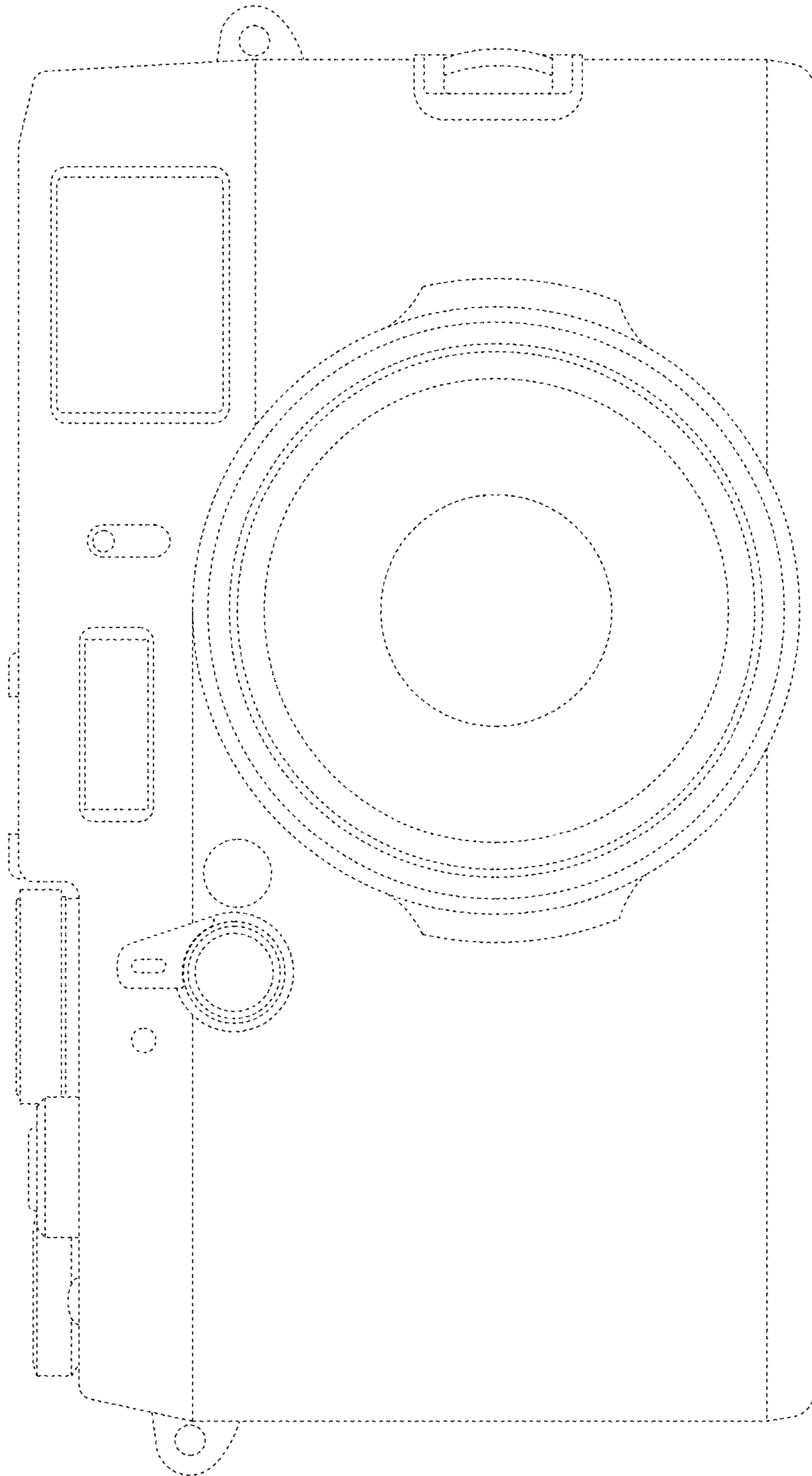

Fig. 5

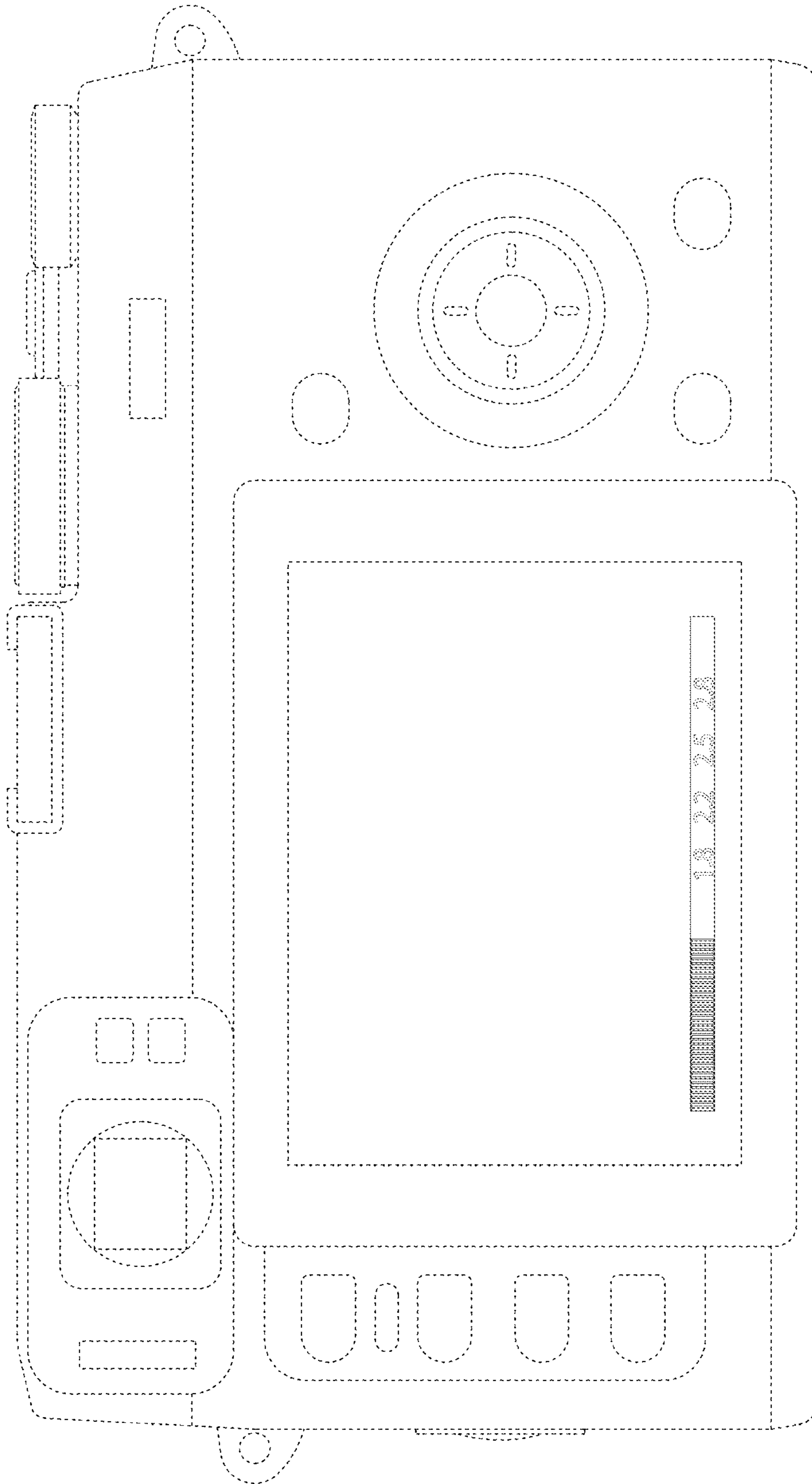

Fig. 7

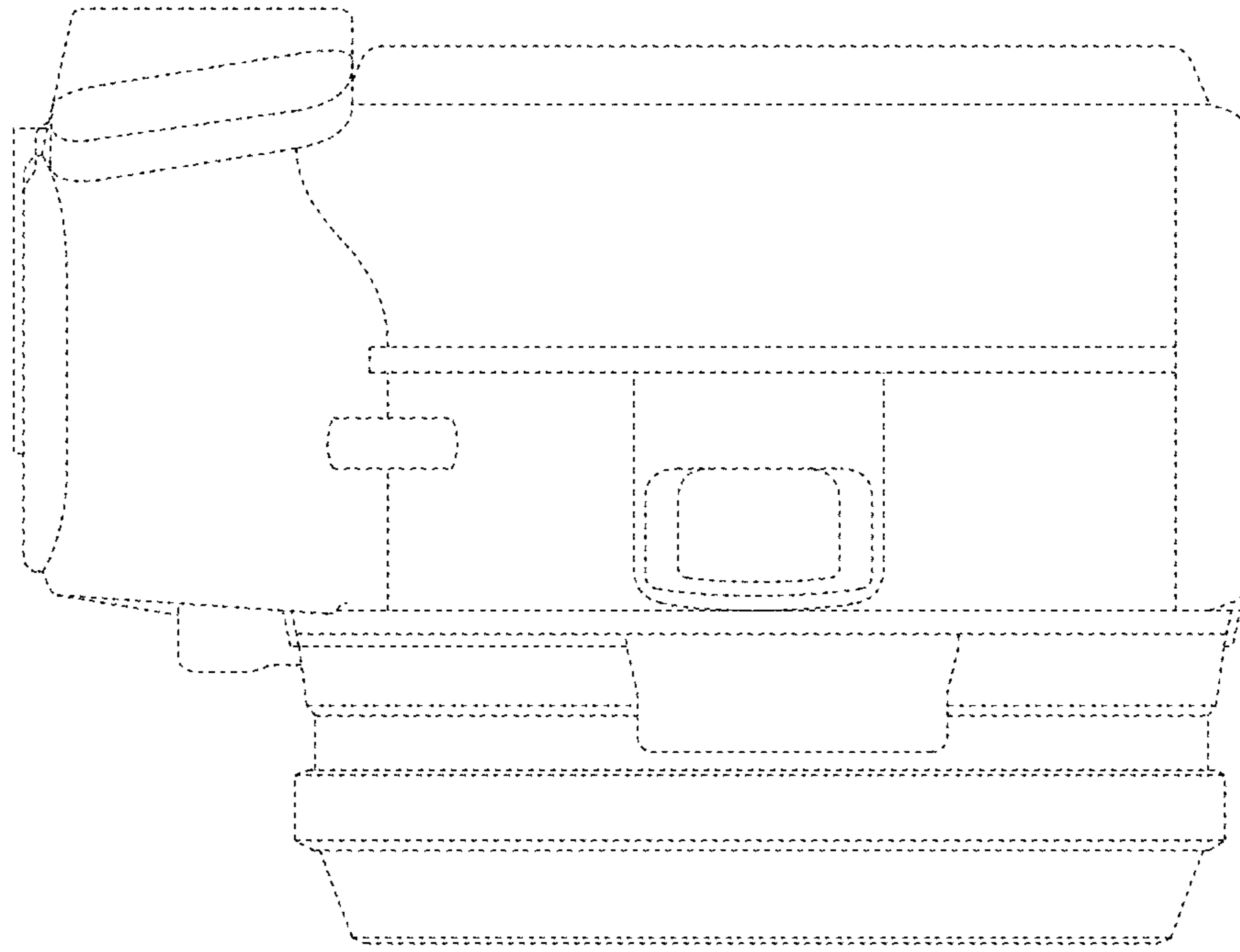

Fig. 6

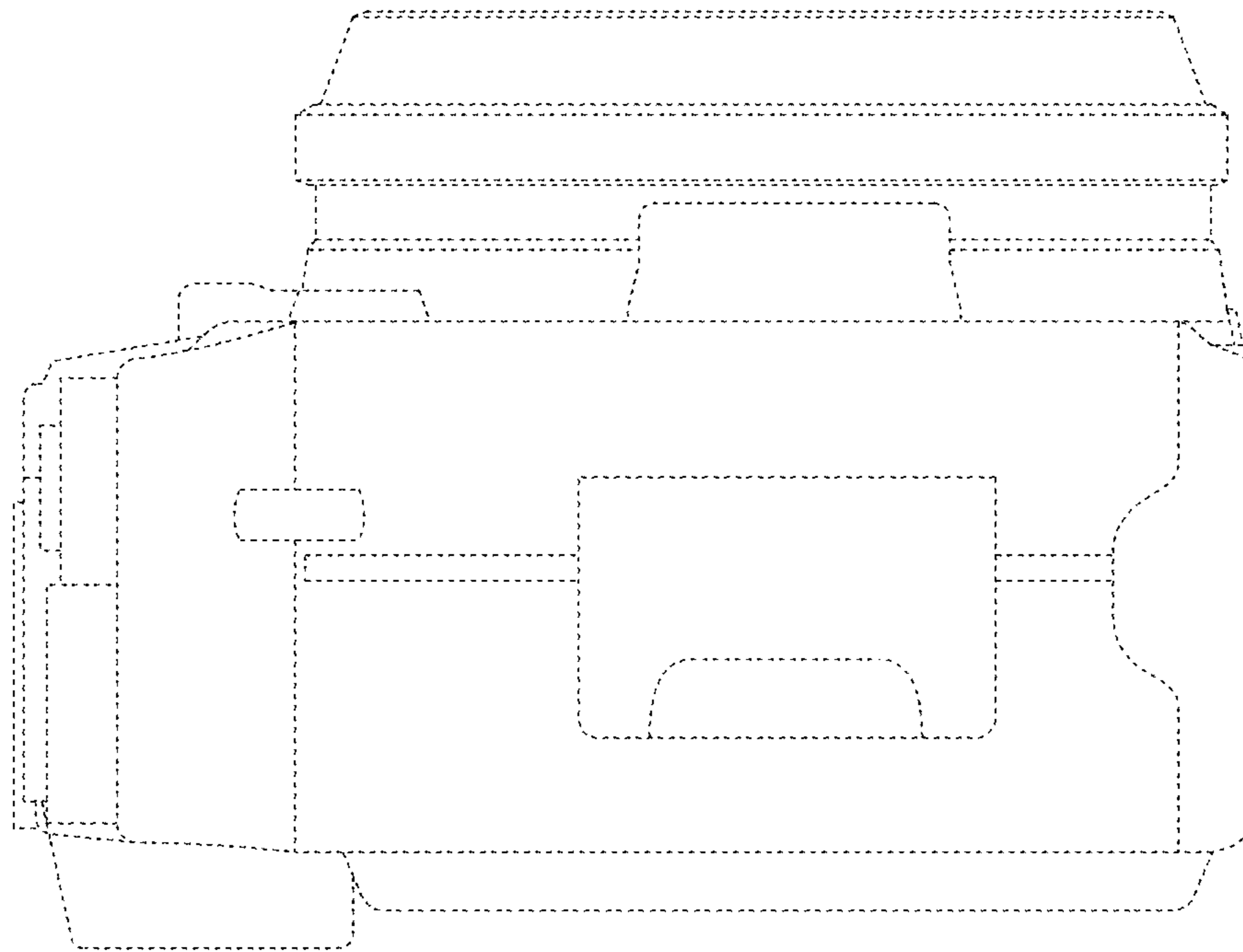

Fig. 8

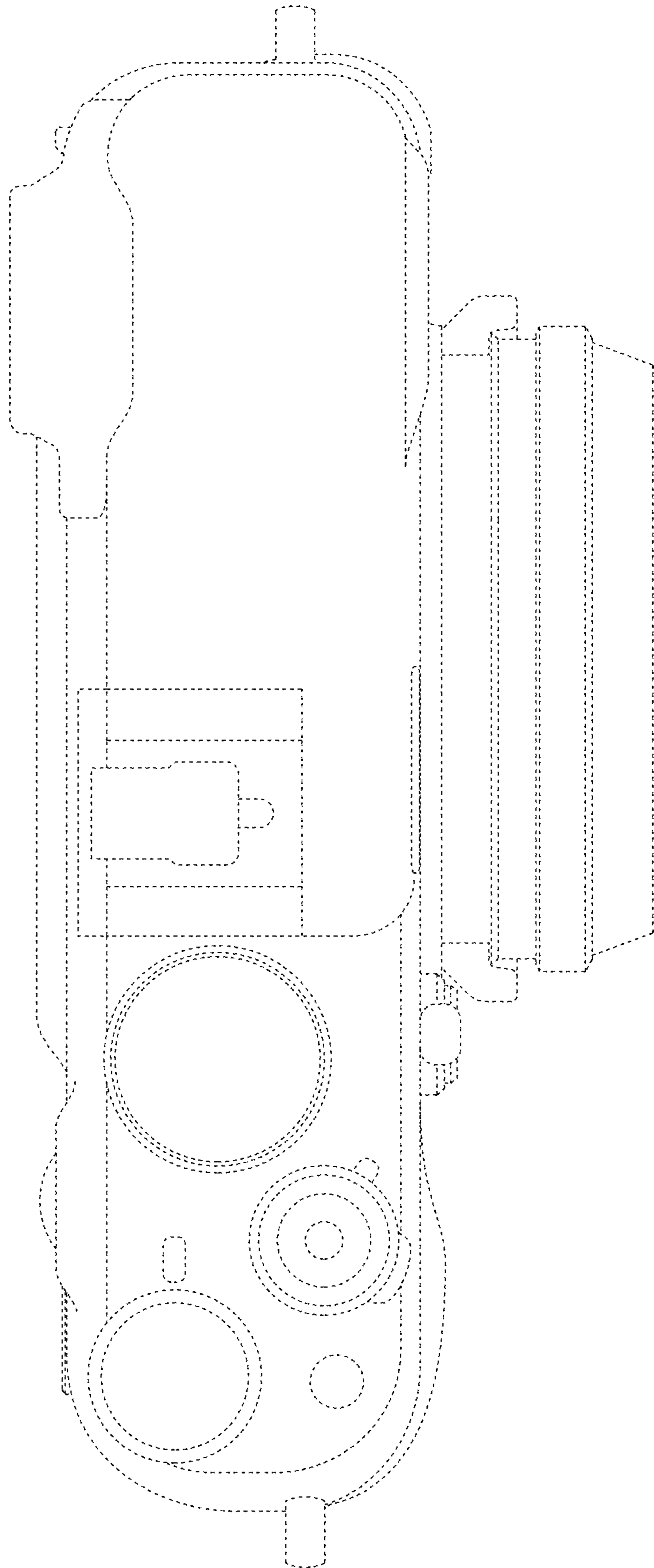

Fig. 9

