



US00D772058S

(12) **United States Design Patent** (10) **Patent No.:** **US D772,058 S**
Urushidani (45) **Date of Patent:** **** Nov. 22, 2016**

(54) **RECTANGULAR TUB**
(71) Applicant: **Société des Produits Nestlé S.A.,**
Vevey (CH)
(72) Inventor: **Yukihiko Urushidani,** Webster Groves,
MO (US)
(73) Assignee: **SOCIETE DES PRODUITS NESTLE**
S.A., Vevey (CH)

D505,840 S 6/2005 Schultz et al.
D514,443 S 2/2006 Sarnoff
D529,797 S 10/2006 Wilcox et al.
D532,689 S 11/2006 Rotta
D554,988 S 11/2007 Sim
D564,711 S 3/2008 Modi et al.
D579,767 S 11/2008 Wallach
D586,652 S 2/2009 Wallach
D589,759 S 4/2009 Ozery et al.

(Continued)

(**) Term: **15 Years**

(21) Appl. No.: **29/536,198**

(22) Filed: **Aug. 14, 2015**

(51) **LOC (10) Cl.** **09-03**

(52) **U.S. Cl.**
USPC **D9/432; D7/602**

(58) **Field of Classification Search**
USPC D9/430, 414, 432, 524, 516; D7/543,
D7/545, 602
CPC B65D 1/00
See application file for complete search history.

(56) **References Cited**

U.S. PATENT DOCUMENTS

D423,732 S 4/2000 McGhee
D428,310 S 7/2000 Zettle et al.
D439,159 S 3/2001 Chen
D440,470 S 4/2001 Tucker et al.
D446,719 S 8/2001 Garraway
D447,688 S 9/2001 Jalet et al.
D465,382 S 11/2002 Wolf et al.
D469,689 S 2/2003 Buchalski et al.
D479,127 S 9/2003 Jowett
D479,128 S 9/2003 Jowett
D490,278 S 5/2004 Welsh
D496,272 S 9/2004 Jackson et al.
D502,394 S 3/2005 Jackson et al.
D505,839 S 6/2005 Stanos et al.

OTHER PUBLICATIONS

Innova Farmhouse Stews, <http://www.amazon.com/Innova-Farmhouse-Stews-8x8oz/dp/B00EHKDZ3S> (last visited Aug. 13, 2015).

(Continued)

Primary Examiner — Cynthia Underwood

(74) *Attorney, Agent, or Firm* — Finnegan, Henderson, Farabow, Garrett & Dunner, LLP

(57) **CLAIM**

The ornamental design for a rectangular tub, as shown and described.

DESCRIPTION

FIG. 1 is a front, top perspective view of a rectangular tub showing my new design.

FIG. 2 is a front elevation view thereof;

FIG. 3 is a rear elevation view thereof;

FIG. 4 is a top plan view thereof;

FIG. 5 is a bottom view thereof;

FIG. 6 is a left side view thereof;

FIG. 7 is a right side view thereof;

FIG. 8 is a cross-section view of the rectangular tub taken along the line 8-8 shown in FIG. 4; and,

FIG. 9 is a cross-section view of the rectangular tub taken along the line 9-9 shown in FIG. 4.

1 Claim, 6 Drawing Sheets

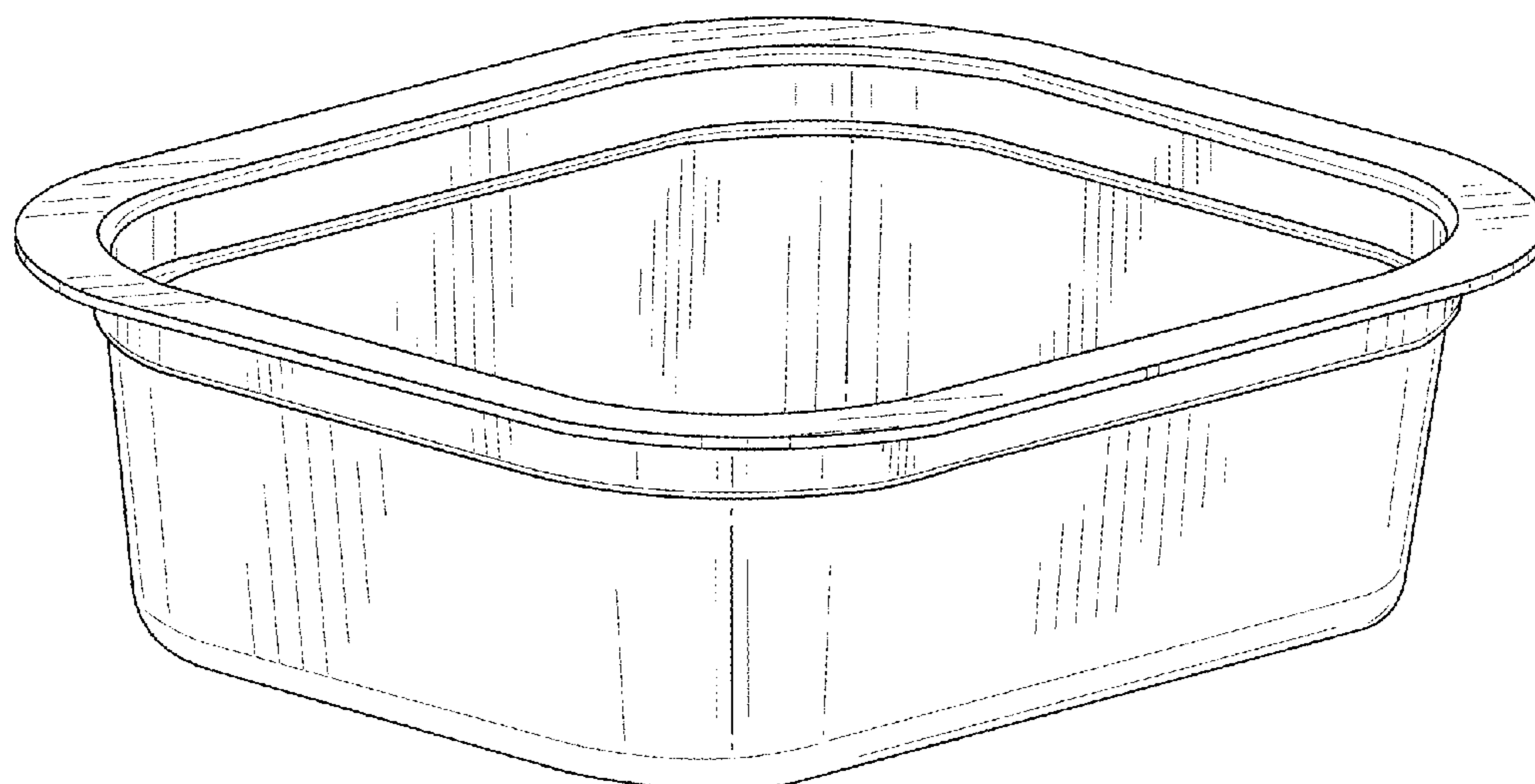

(56)

References Cited

OTHER PUBLICATIONS

U.S. PATENT DOCUMENTS

D591,591 S	5/2009	Moecks et al.	
D592,499 S	5/2009	Colacitti	
D593,369 S	* 6/2009	Green	D7/602
D594,325 S	6/2009	Colacitti	
D605,936 S	12/2009	Durdon et al.	
D614,950 S	5/2010	Colacitti	
D628,060 S	11/2010	Wallach et al.	
D640,548 S	* 6/2011	Lawrence	D9/430
D649,033 S	11/2011	Epstein	
D649,410 S	11/2011	Segal	
D656,367 S	3/2012	Segal	
D656,368 S	3/2012	Segal	
D666,875 S	9/2012	Rusnak	
D671,373 S	11/2012	Kimmel et al.	
D675,929 S	2/2013	Park et al.	
D679,587 S	* 4/2013	Krueger	D9/432
D690,198 S	* 9/2013	Haracourt	D7/602
D697,402 S	1/2014	Rosi	
D699,568 S	2/2014	Epstein et al.	
D741,166 S	* 10/2015	Tyberghein	D9/425
D748,945 S	* 2/2016	Chase	D7/545

U.S. Trademark Application No. 76-202,217, filed Jan. 31, 2001, by Saturn PetFood GmbH.

U.S. Trademark Application No. 85-947,957, filed May 31, 2013, by conSup North America, Inc.

U.S. Trademark Application No. 86-149,435, filed Dec. 20, 2013, by Contantia Teich GmbH.

U.S. Trademark Registration No. 2,052,069, registered Apr. 15, 1997, to Kal Kan Foods, Inc.

U.S. Trademark Registration No. 2,052,071, registered Apr. 15, 1997, to Kal Kan Foods, Inc.

U.S. Trademark Registration No. 2,996,958, registered Sep. 20, 2005, to Compagnie Laitiere Europeenne.

U.S. Trademark Registration No. 3,413,776, registered Apr. 15, 2008, to Societe Des Produits Nestle S.A.

U.S. Trademark Registration No. 4,697,939, registered Mar. 10, 2015, to NatureSweet, Ltd.

* cited by examiner

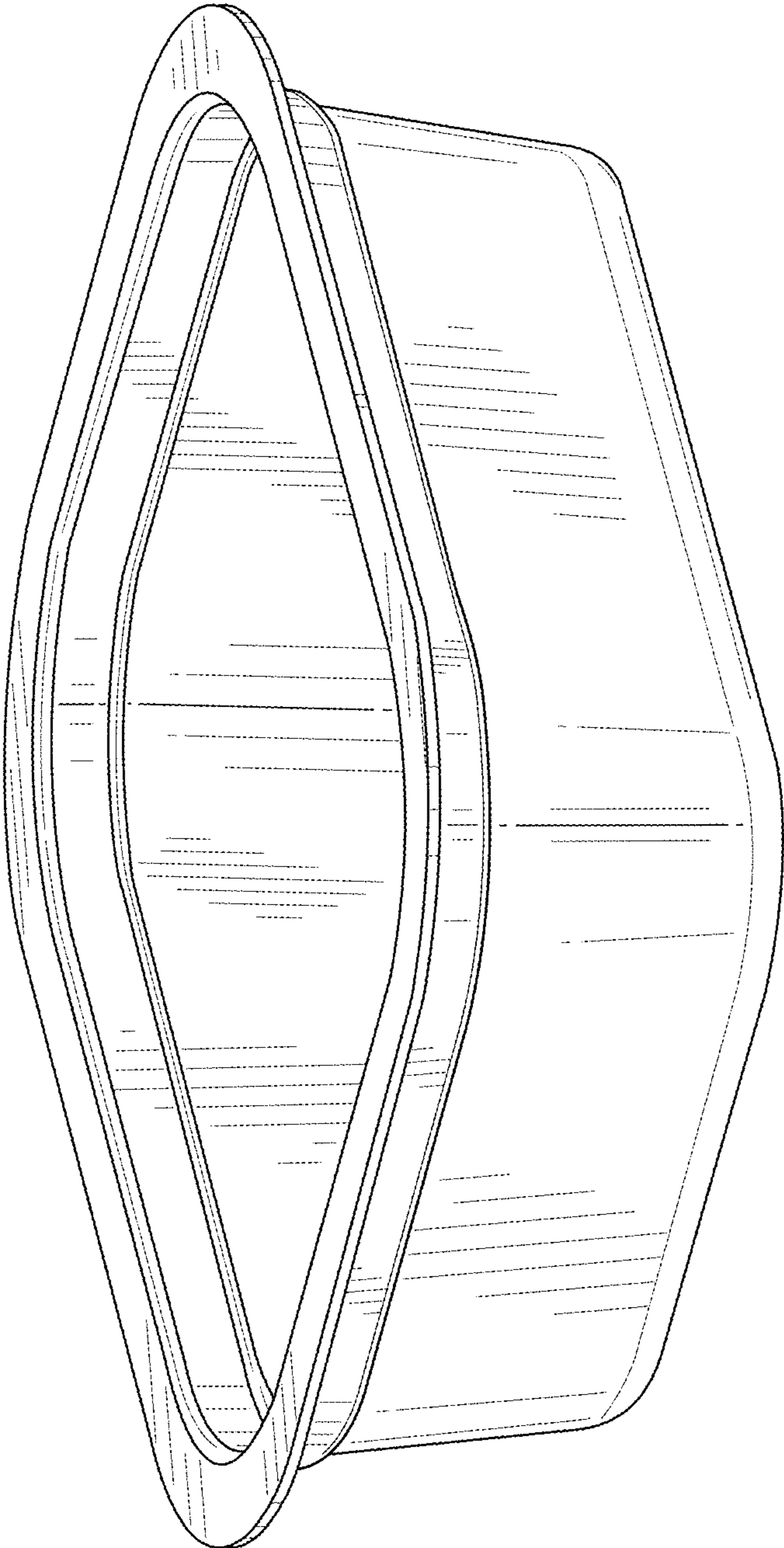

FIG. 1

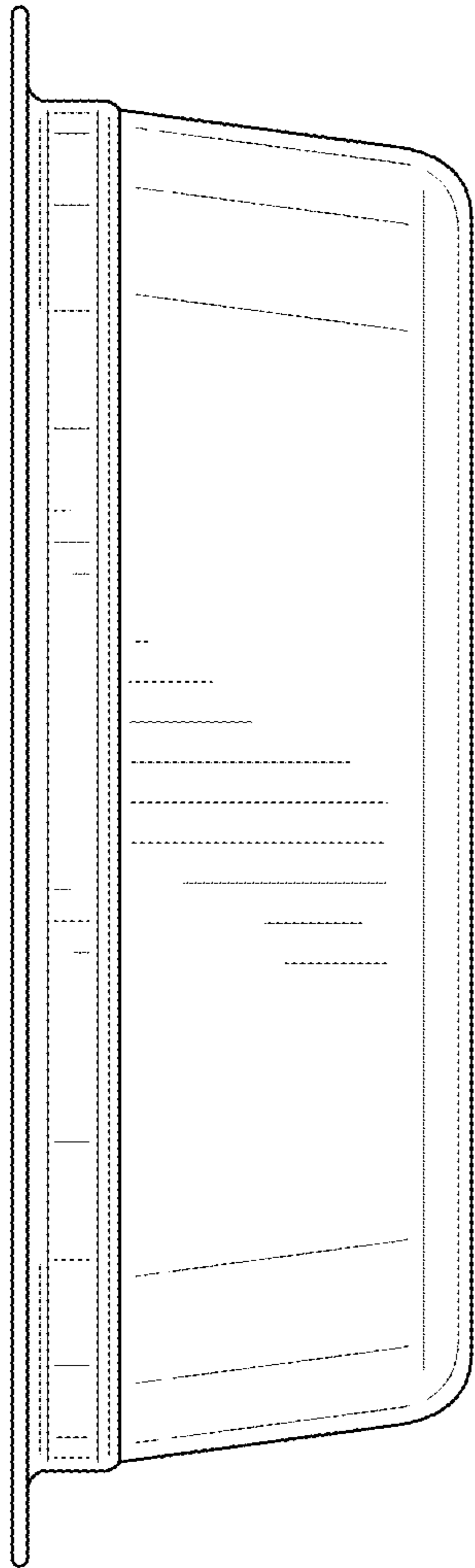

FIG. 2

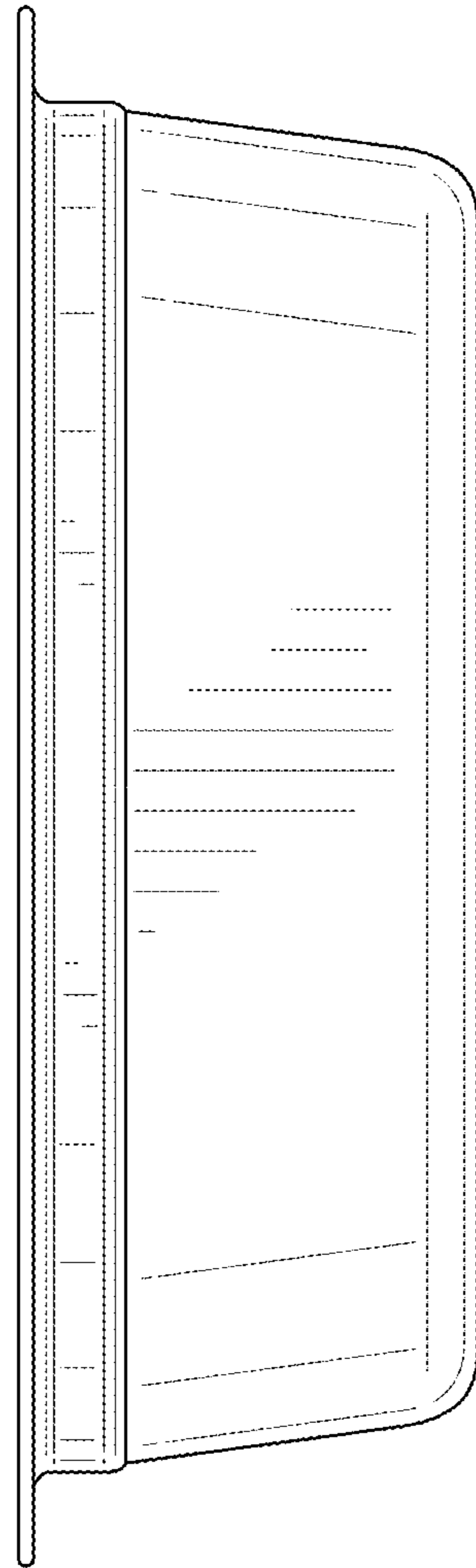

FIG. 3

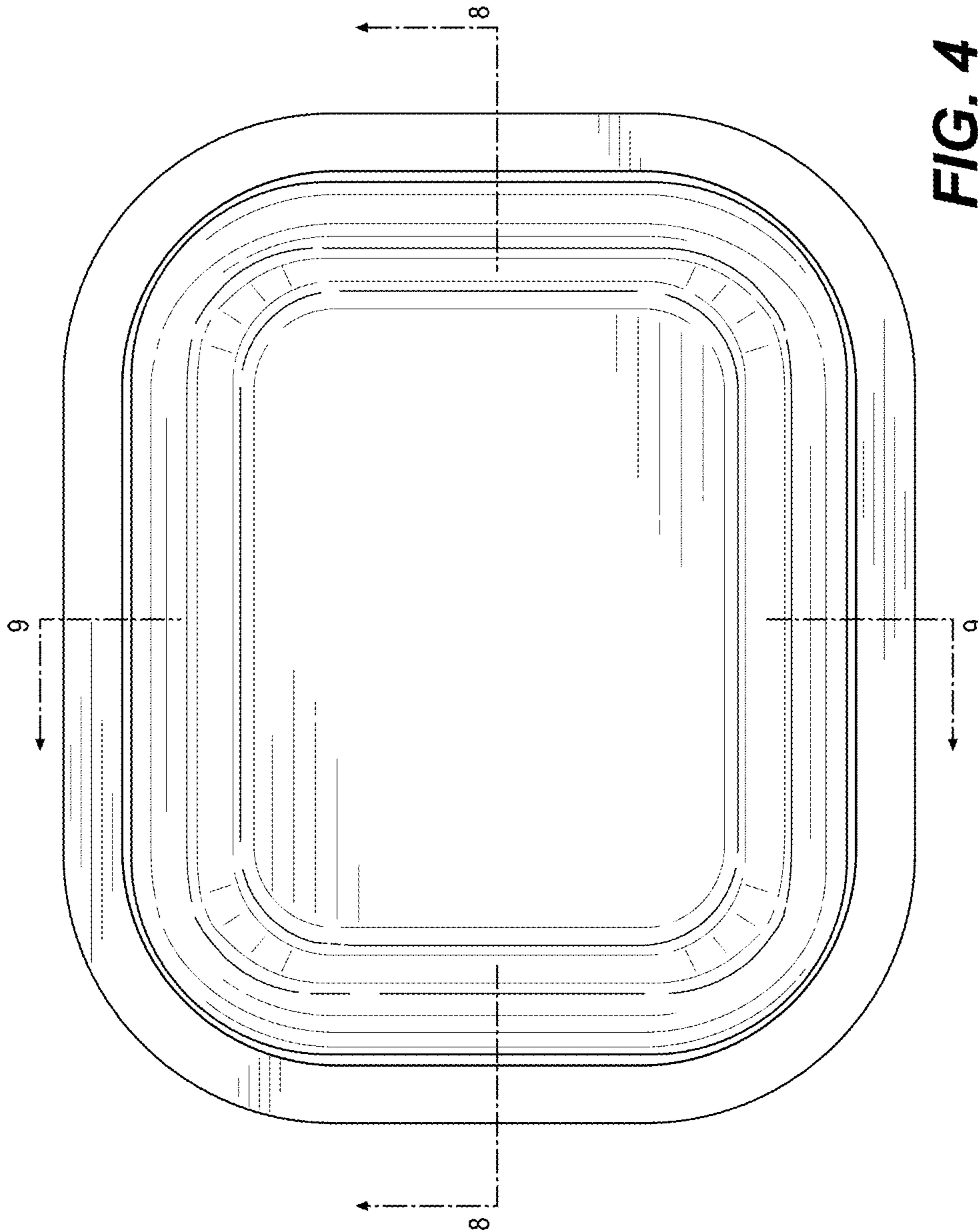

FIG. 4

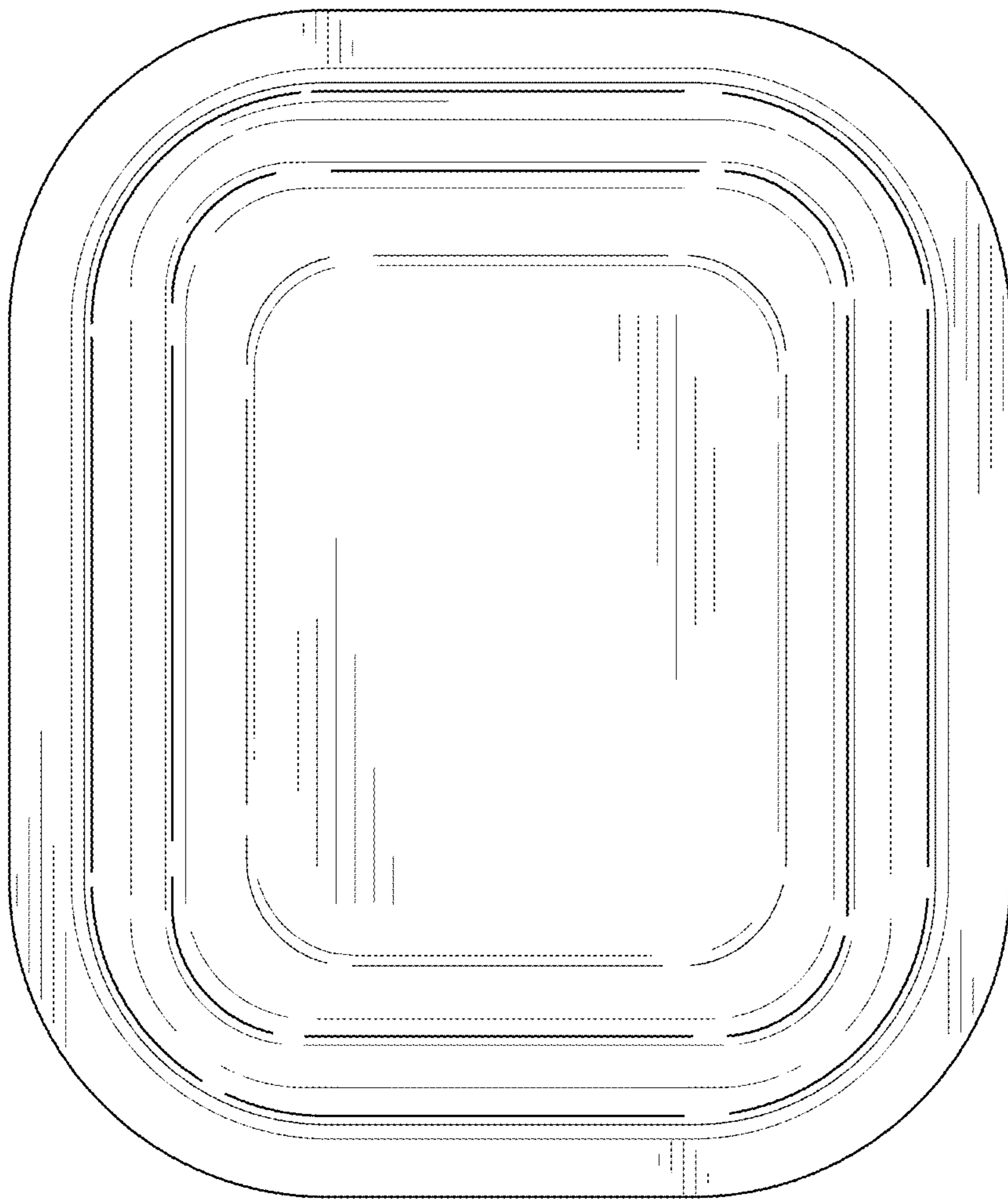

FIG. 5

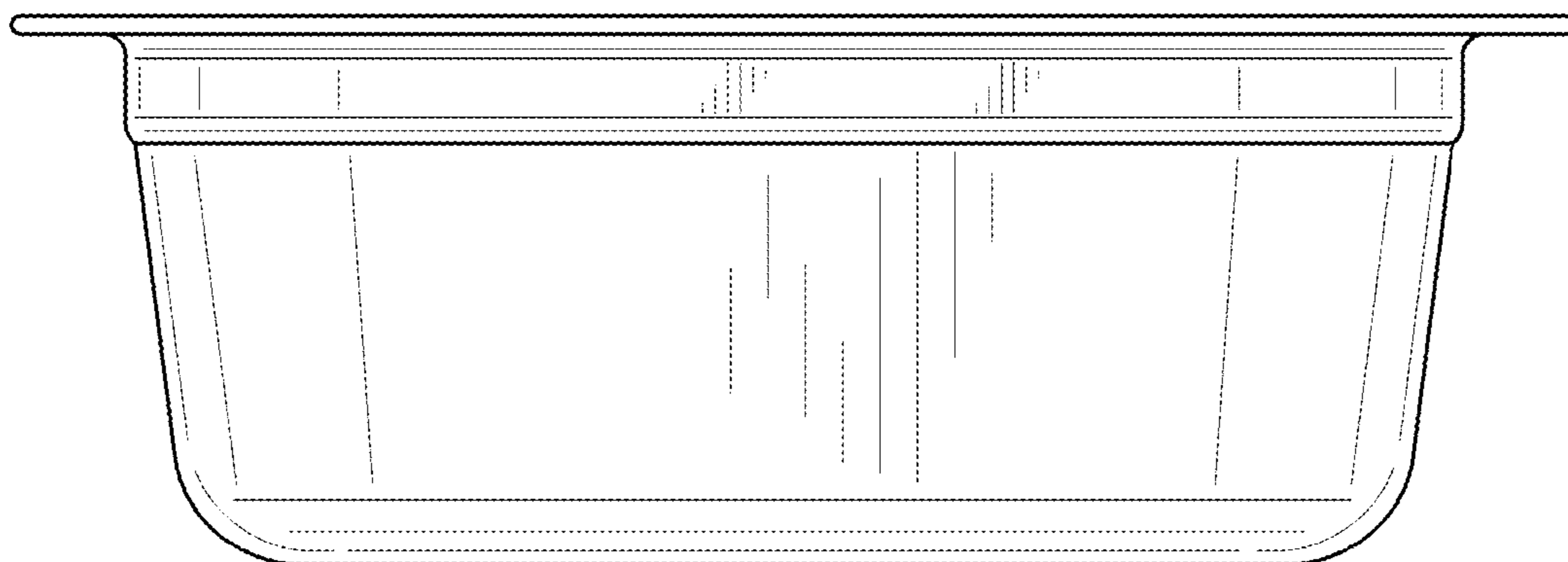

FIG. 6

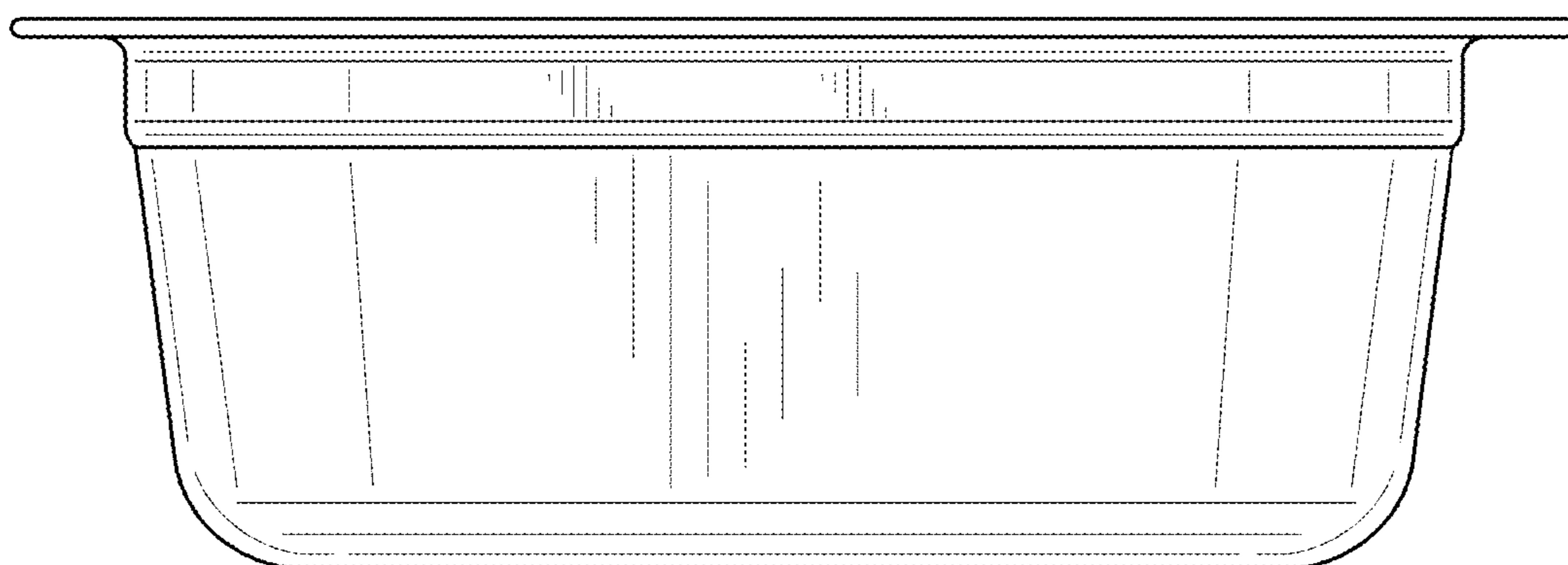

FIG. 7

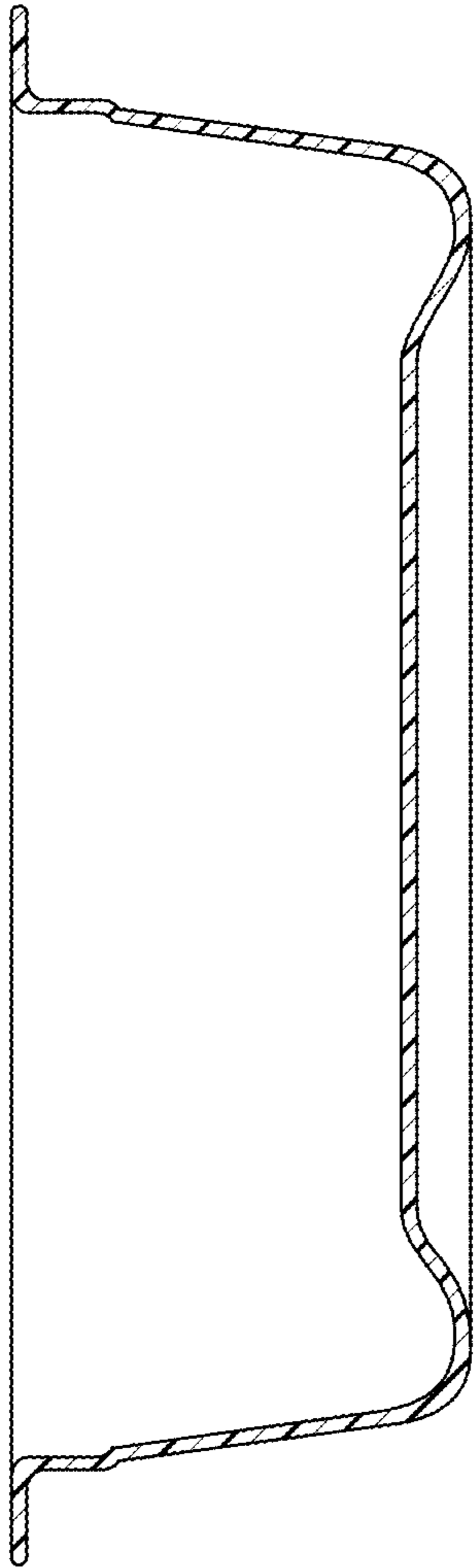

FIG. 8

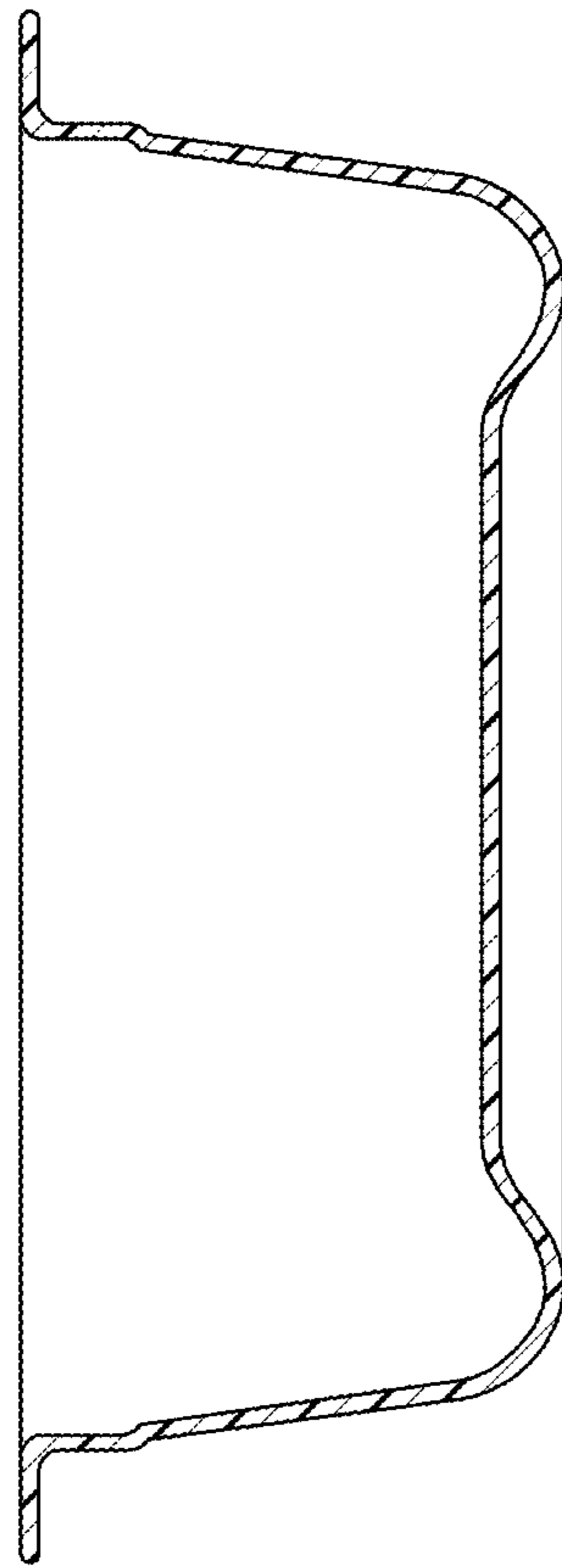

FIG. 9