



US00D772043S

(12) **United States Design Patent** (10) **Patent No.:** **US D772,043 S**  
**Forrest et al.** (45) **Date of Patent:** **\*\* Nov. 22, 2016**

(54) **HOOK**  
(71) Applicant: **LIBERTY HARDWARE MFG. CORP.**, Winston-Salem, NC (US)  
(72) Inventors: **Earl David Forrest**, Asheboro, NC (US); **James Leroy Daniels**, Stokesdale, NC (US)  
(73) Assignee: **LIBERTY HARDWARE MFG. CORP.**, Winston-Salem, NC (US)

*Primary Examiner* — Holly Baynham  
(74) *Attorney, Agent, or Firm* — Brooks Kushman P.C.; Lora Graentzdoerffer

(\*\*) Term: **14 Years**

(57) **CLAIM**  
The ornamental design for a hook, as shown and described.

(21) Appl. No.: **29/508,327**  
(22) Filed: **Nov. 5, 2014**  
(51) **LOC (10) Cl.** ..... **08-05**  
(52) **U.S. Cl.**  
USPC ..... **D8/367**  
(58) **Field of Classification Search**  
USPC ..... D8/372, 367  
CPC ..... A47G 1/20; A47G 7/045; A47J 47/16  
See application file for complete search history.

**DESCRIPTION**

FIG. 1 is a perspective view of a hook according to an embodiment;  
FIG. 2 is a front view of the hook of FIG. 1;  
FIG. 3 is a rear view of the hook of FIG. 1;  
FIG. 4 is a top view of the hook of FIG. 1;  
FIG. 5 is a bottom view of the hook of FIG. 1;  
FIG. 6 is a right side view of the hook of FIG. 1;  
FIG. 7 is a left side view of the hook of FIG. 1;  
FIG. 8 is a perspective view of a hook according to another embodiment;  
FIG. 9 is a front view of the hook of FIG. 8;  
FIG. 10 is a rear view of the hook of FIG. 8;  
FIG. 11 is a top view of the hook of FIG. 8;  
FIG. 12 is a bottom view of the hook of FIG. 8;  
FIG. 13 is a right side view of the hook of FIG. 8; and,  
FIG. 14 is a left side view of the hook of FIG. 8.  
The broken lines are for illustrative purposes only and form no part of the claimed design.

(56) **References Cited**  
**U.S. PATENT DOCUMENTS**  
D706,614 S \* 6/2014 Schraufnagel ..... D8/372  
D707,539 S \* 6/2014 Goodman ..... D8/372  
D707,542 S \* 6/2014 Goodman ..... D8/372  
**OTHER PUBLICATIONS**  
[http://www.lowes.com/pd\\_45850-695-46120CT\\_0\\_?productId=1087645](http://www.lowes.com/pd_45850-695-46120CT_0_?productId=1087645), "Shop interDesign Steel Garment Hook at Lowes.com", sold on and/or before the date of Oct. 13, 2014.

\* cited by examiner

**1 Claim, 6 Drawing Sheets**

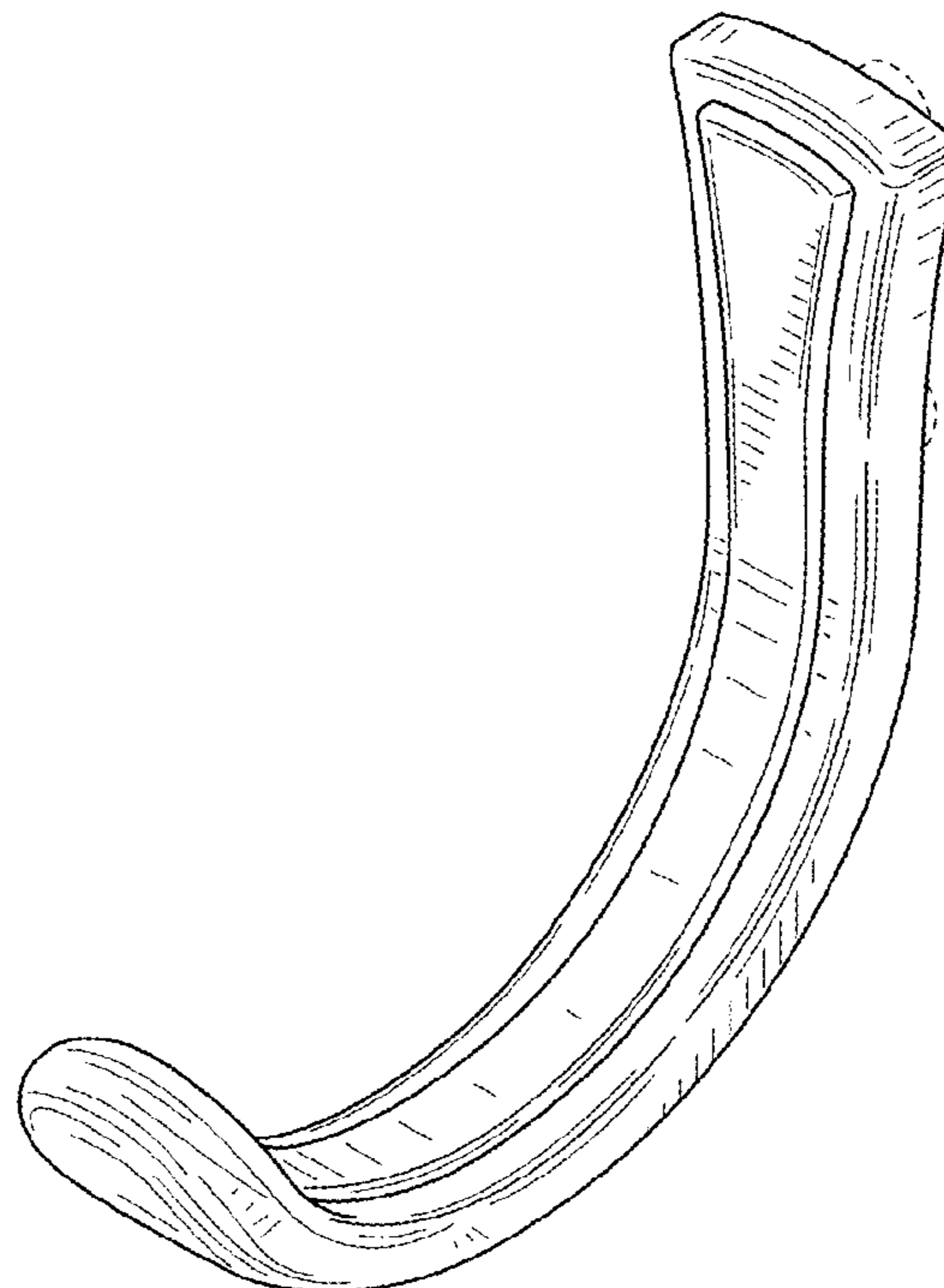

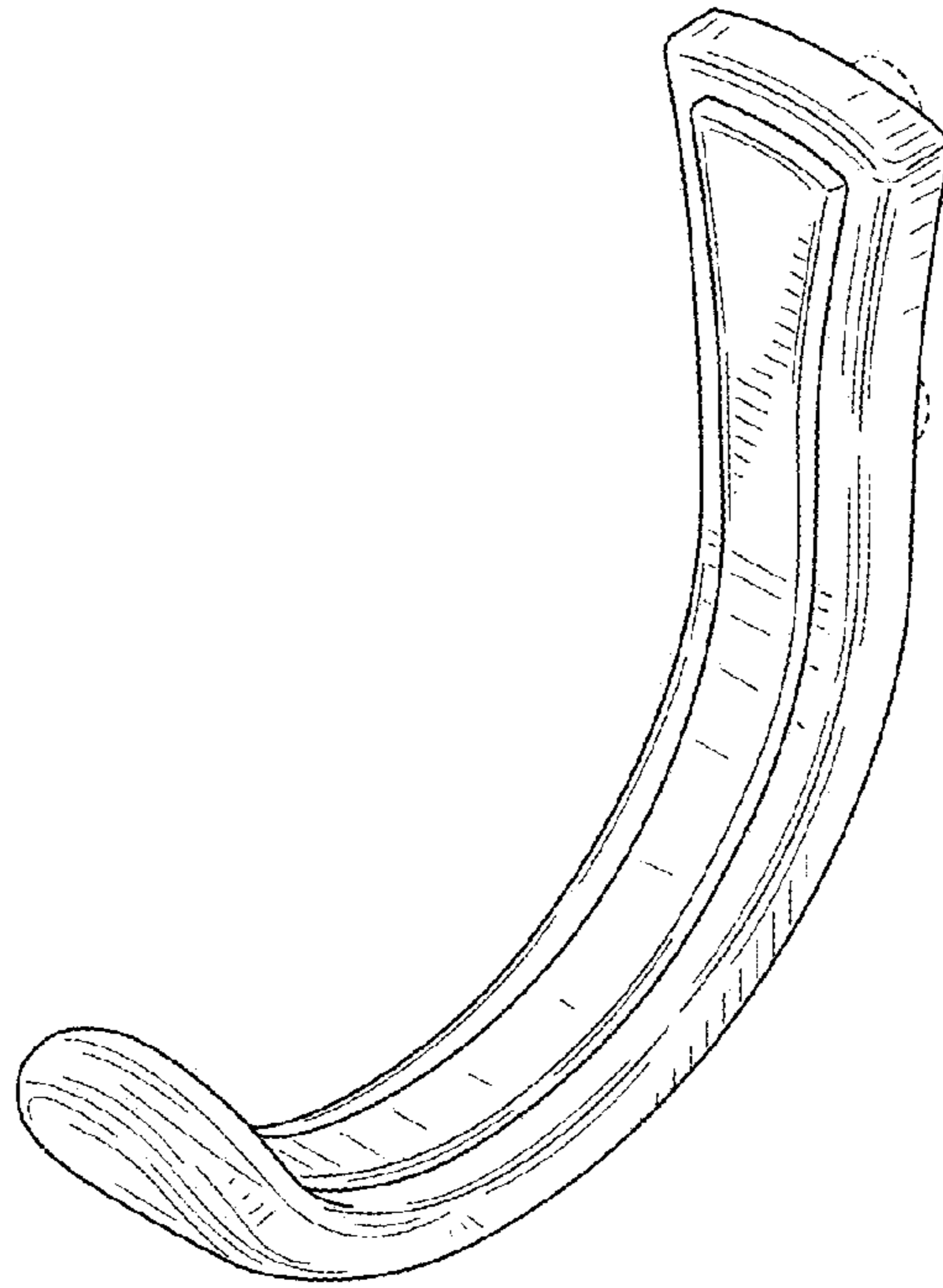

FIG. 1

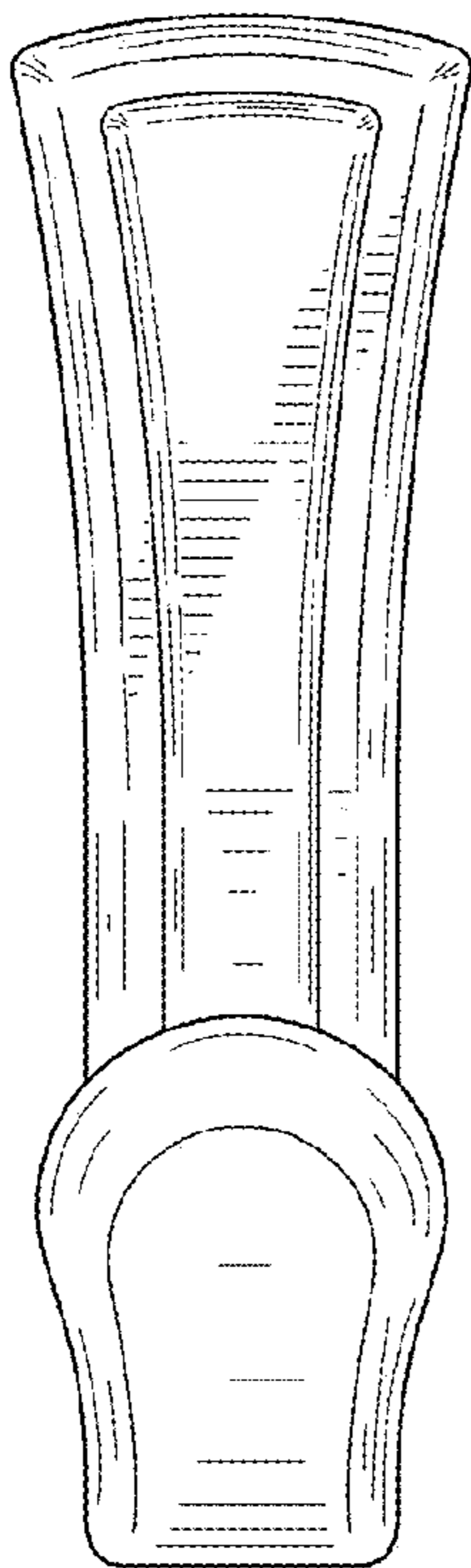

FIG. 2

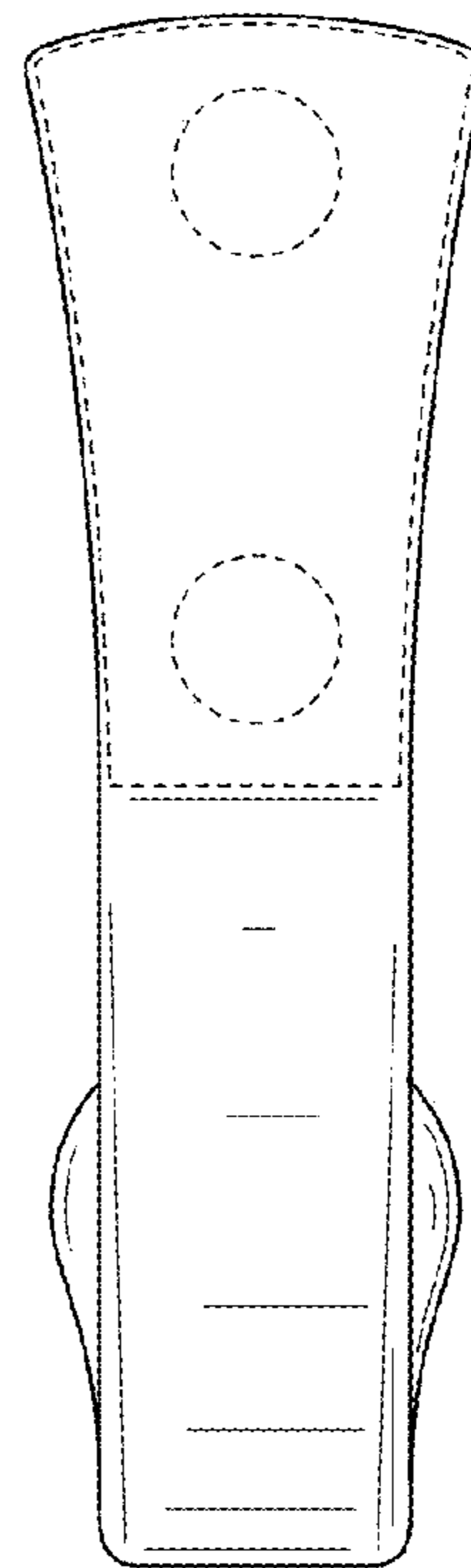
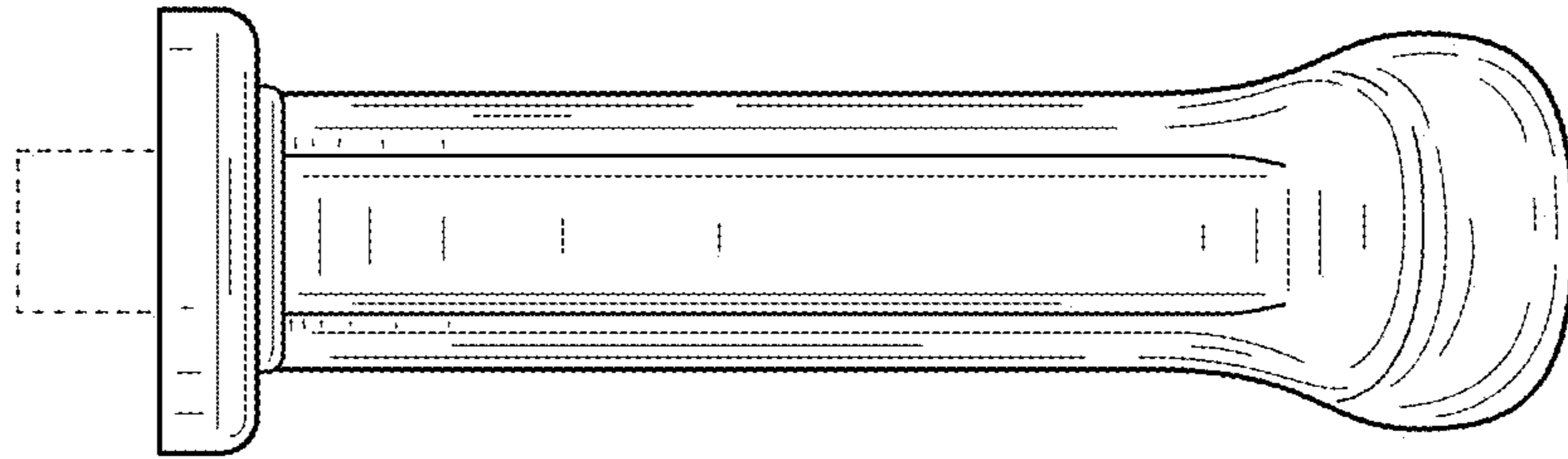
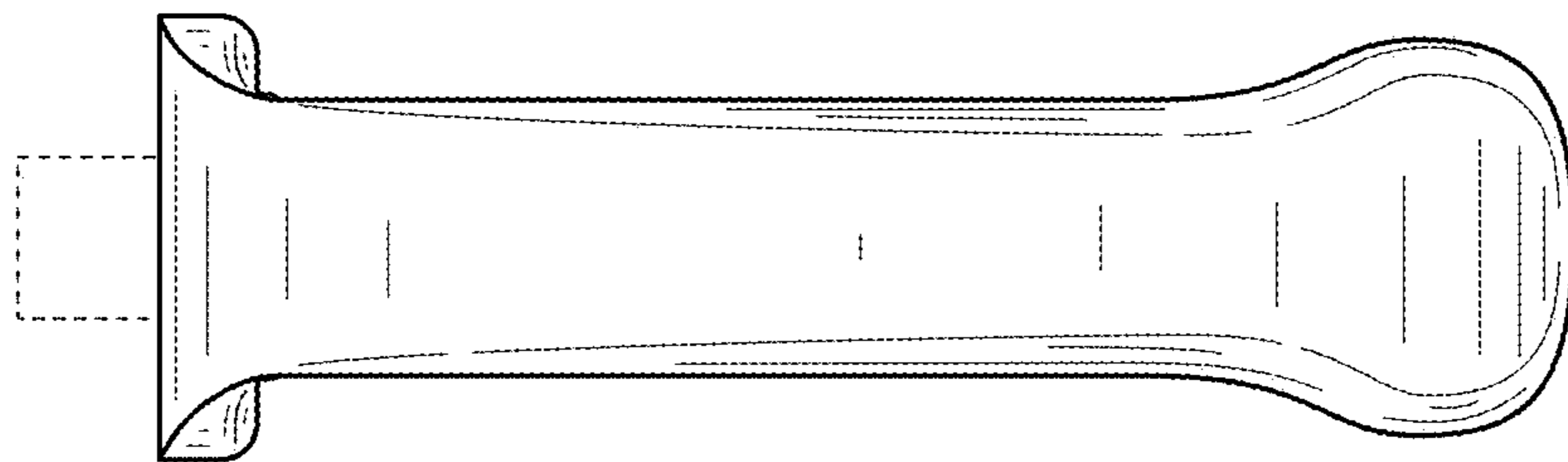

FIG. 3



**FIG. 4**



**FIG. 5**

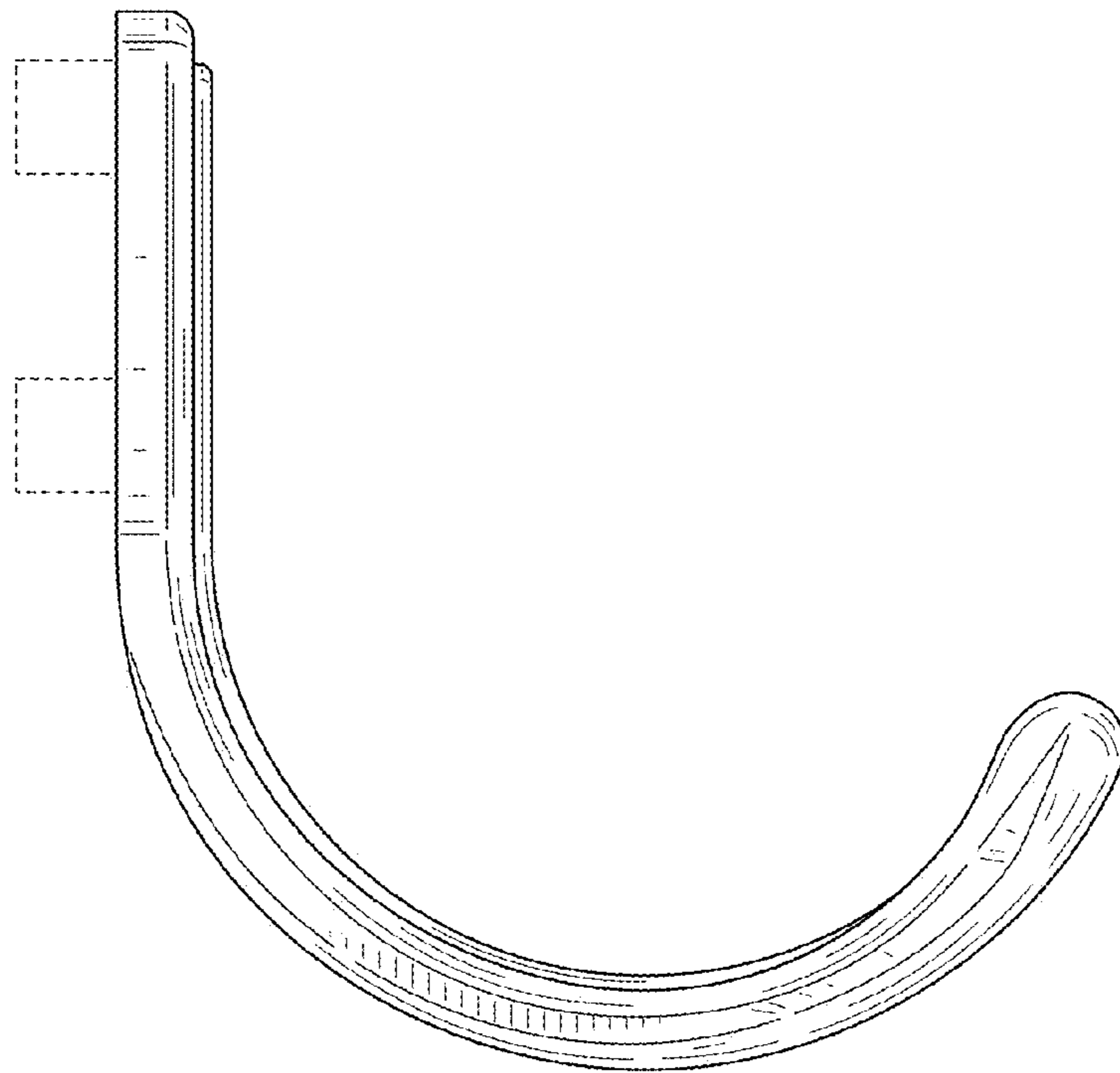

FIG. 6

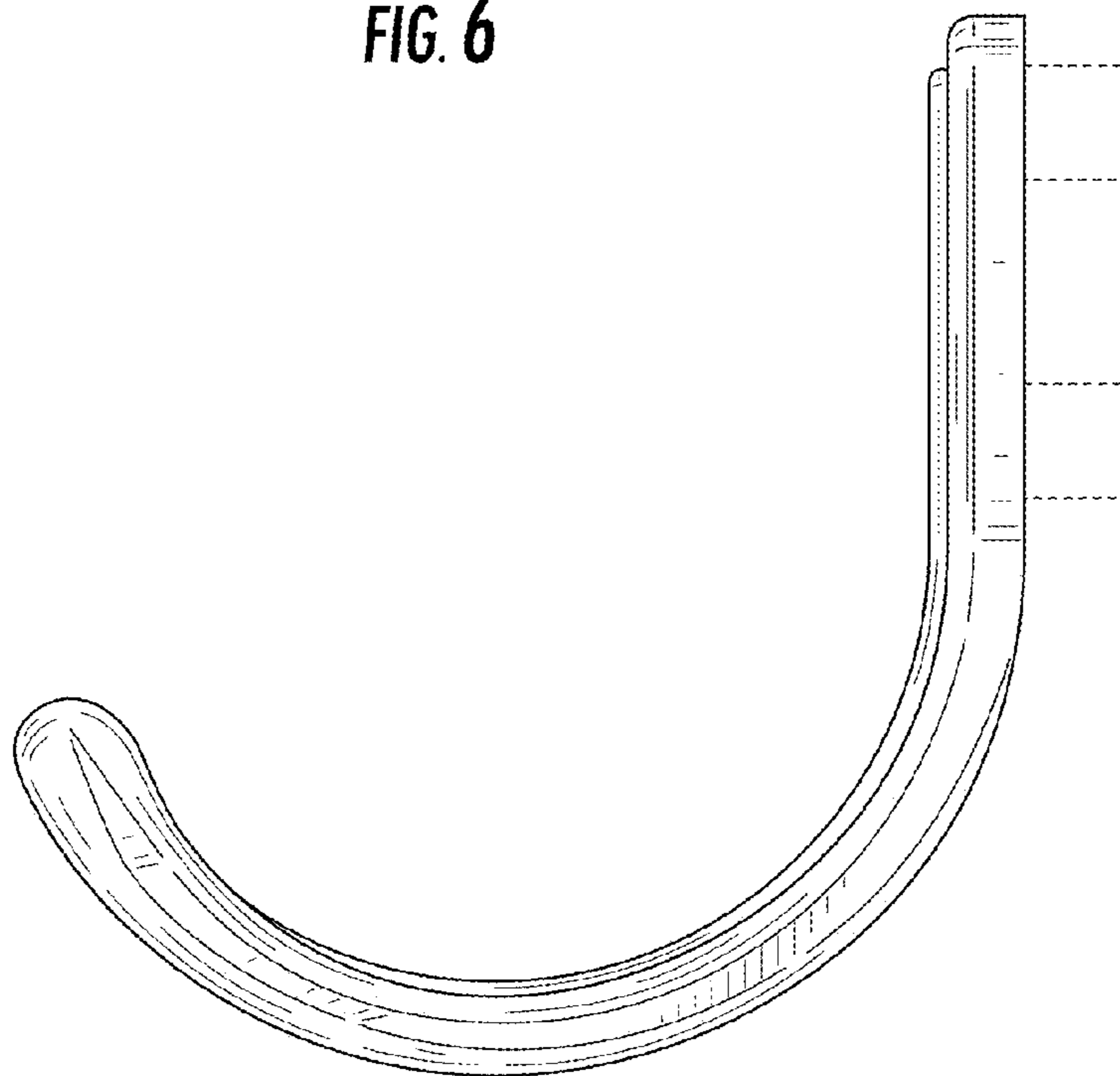

FIG. 7

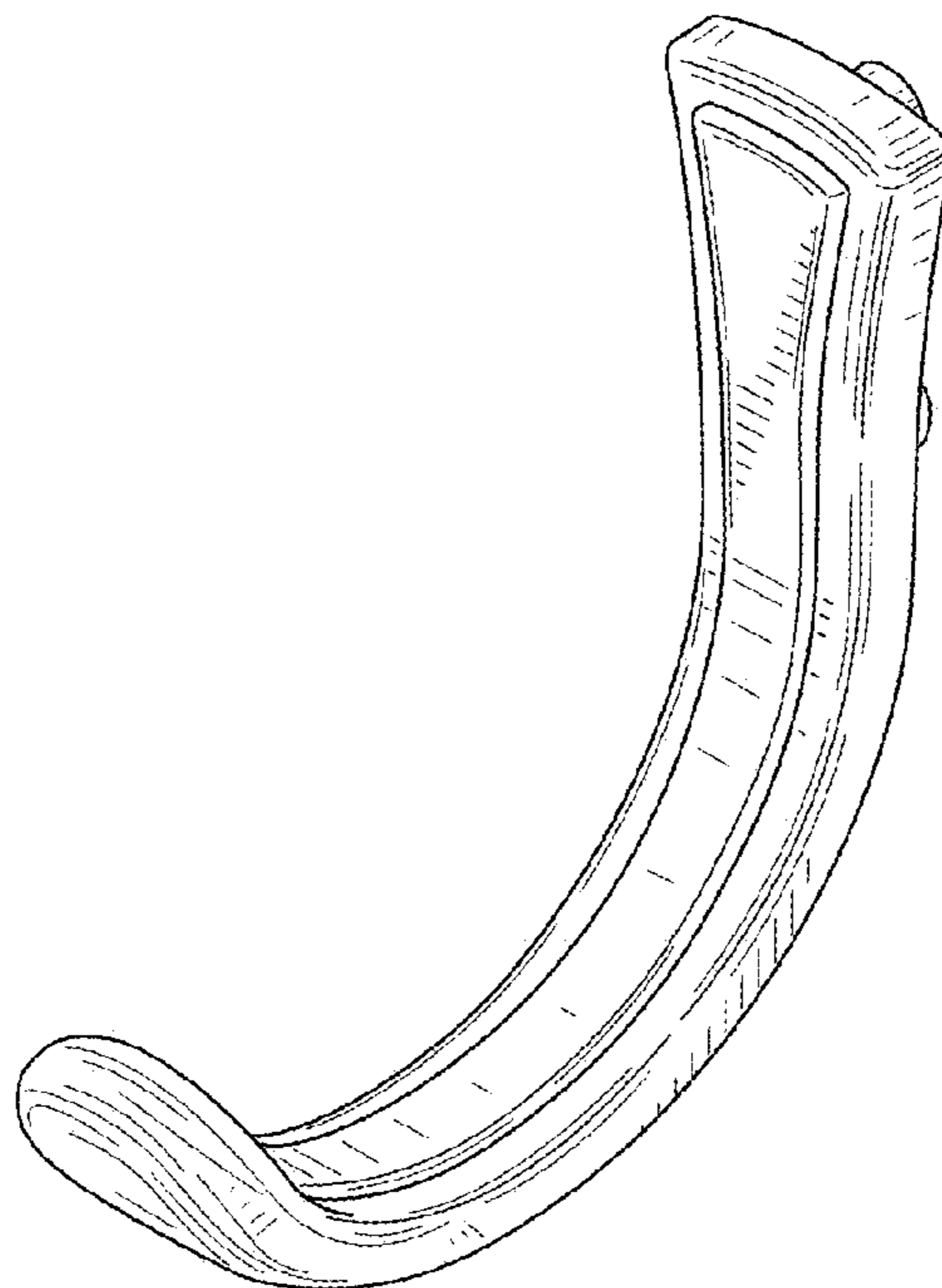

FIG. 8

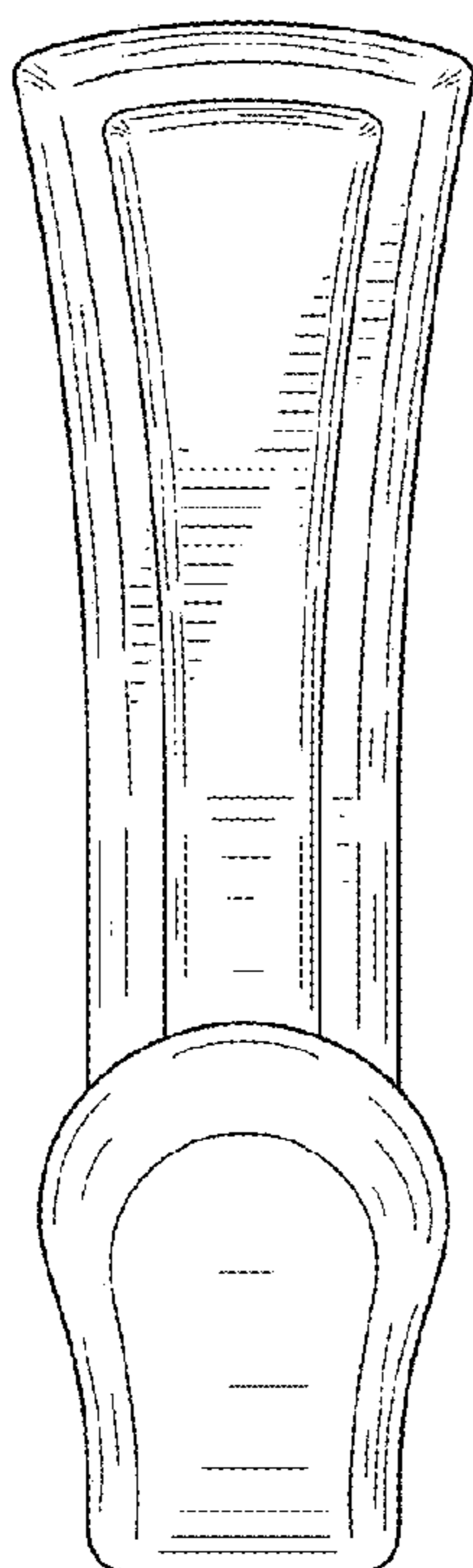

FIG. 9

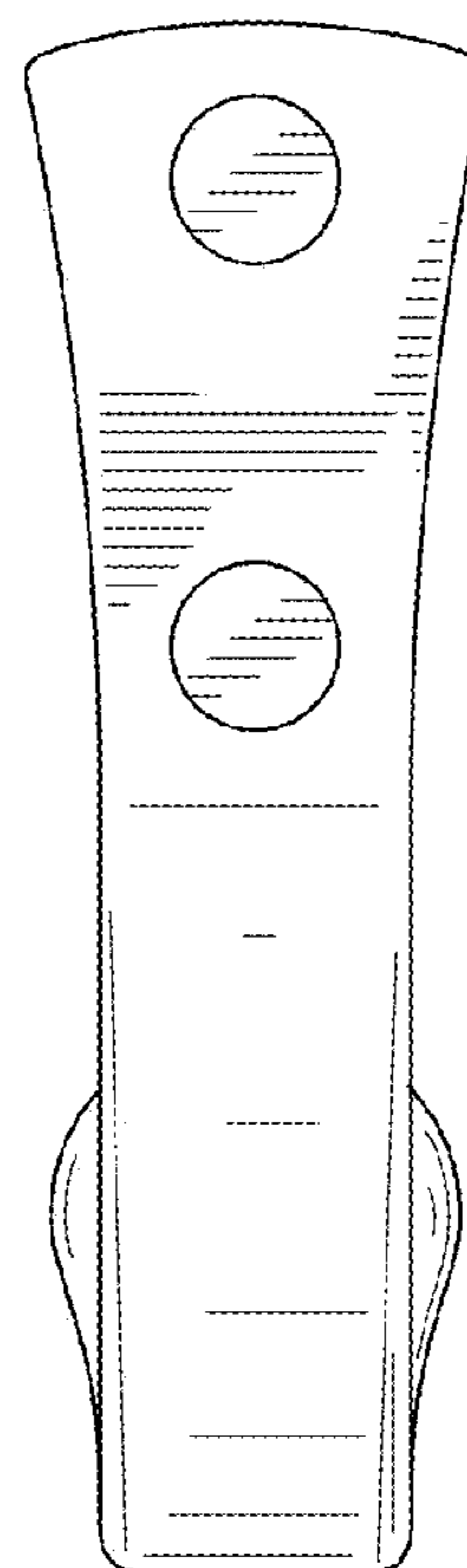
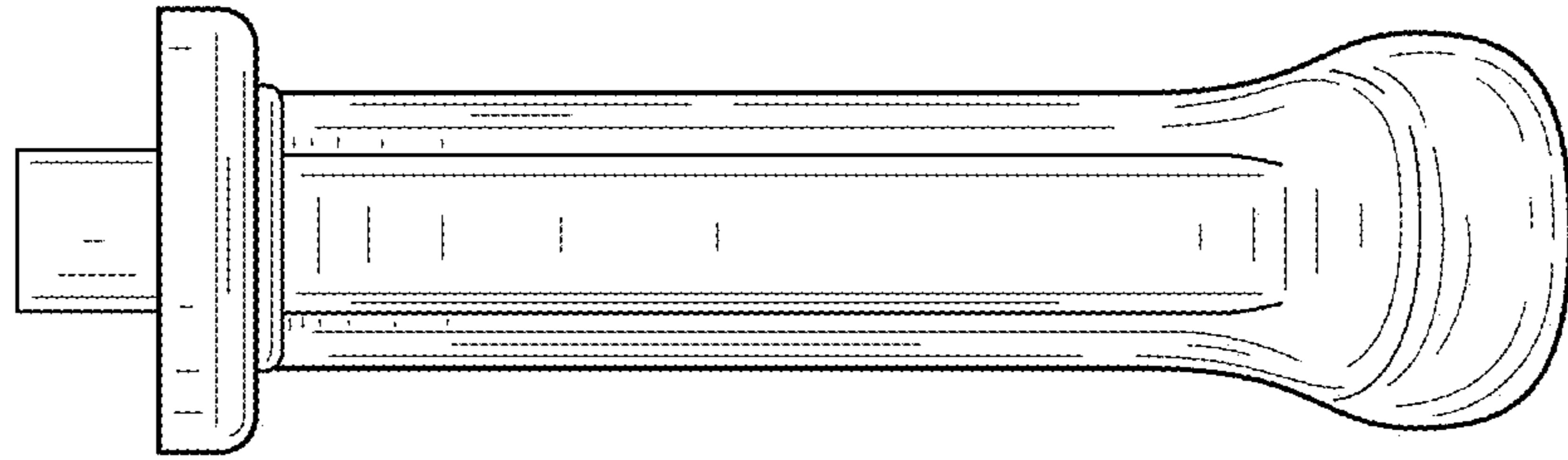
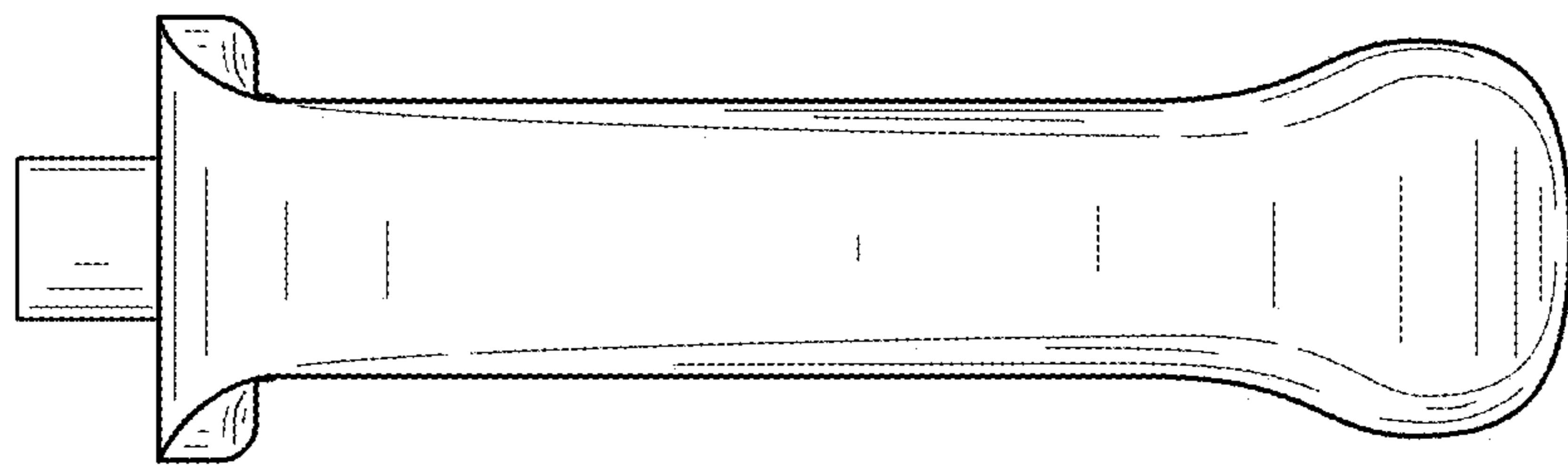

FIG. 10



**FIG. 11**



**FIG. 12**

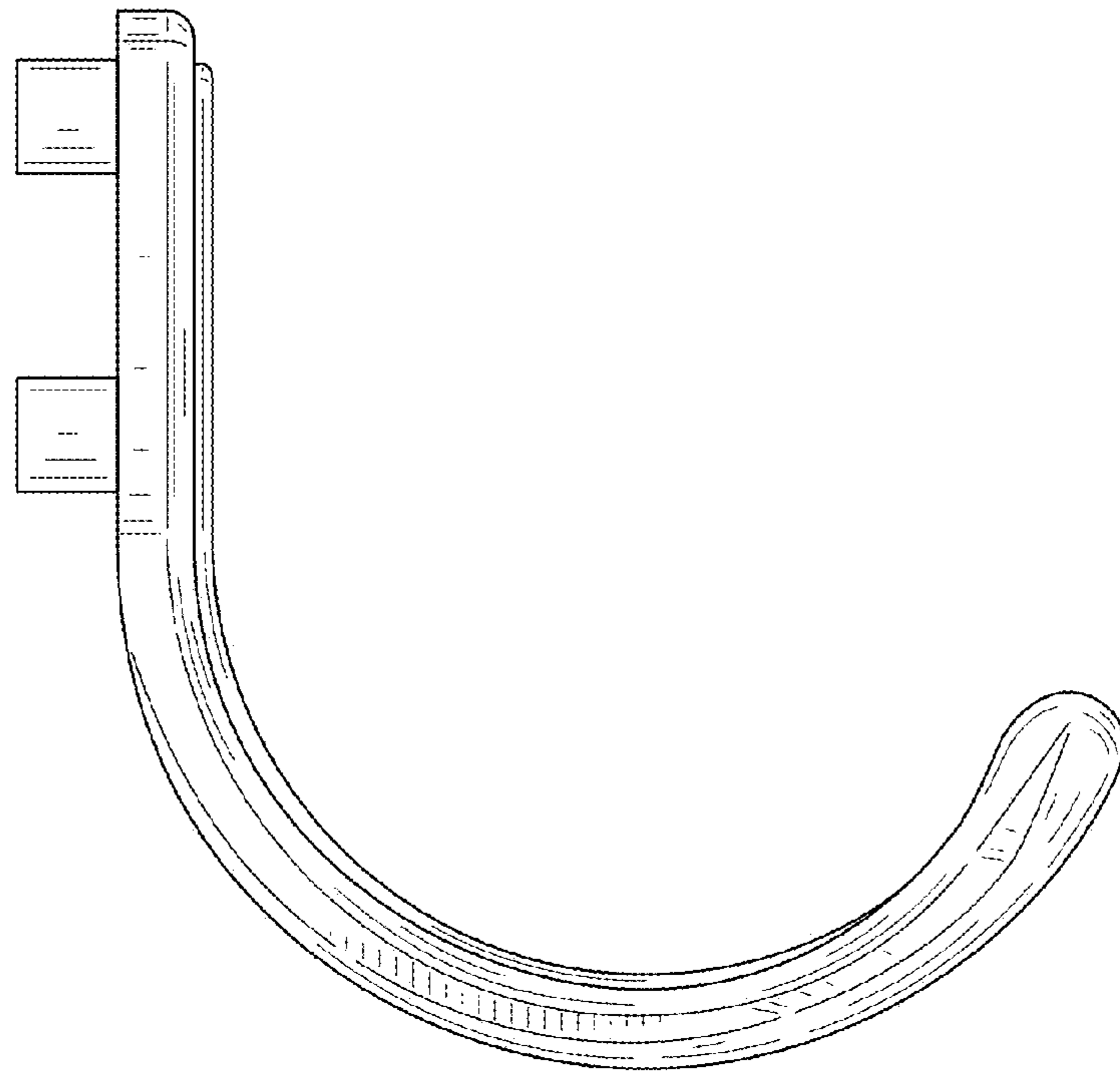

FIG. 13

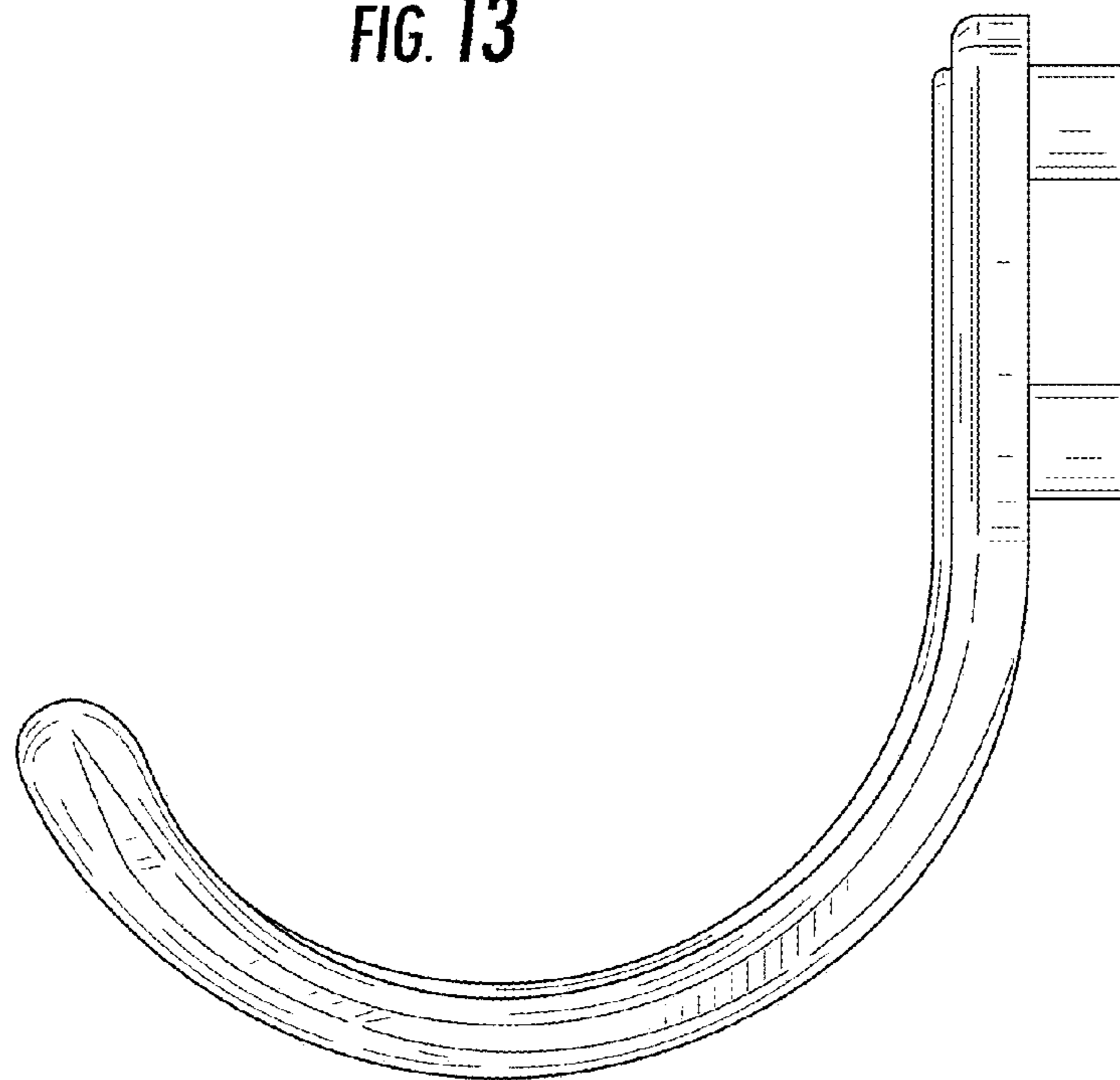

FIG. 14