



US00D772001S

(12) **United States Design Patent**
Kemker et al.

(10) **Patent No.:** **US D772,001 S**

(45) **Date of Patent:** **** Nov. 22, 2016**

(54) **FOOD PREPARATION APPLIANCE**

(71) Applicant: **Vorwerk & Co. Interholding GmbH**,
Wuppertal (DE)

(72) Inventors: **Uwe Kemker**, Wuppertal (DE); **Felix Thies**, Wuppertal (DE)

(73) Assignee: **Vorwerk & Co. Interholding GmbH**,
Wuppertal (DE)

(**) Term: **15 Years**

(21) Appl. No.: **29/544,777**

(22) Filed: **Nov. 6, 2015**

Related U.S. Application Data

(62) Division of application No. 29/501,270, filed on Sep. 3, 2014, now Pat. No. Des. 751,857.

(51) **LOC (10) Cl.** **31-00**

(52) **U.S. Cl.**
USPC **D7/386; D7/376; D7/378; D7/384**

(58) **Field of Classification Search**
USPC D7/326, 372, 376–386, 412–413, 602,
D7/629, 665–666, 669, 679, 693–694
CPC A21C 1/02; A21C 1/04; A23N 1/00;
A23N 1/02; A47J 27/004; A47J 36/165;
A47J 43/04; A47J 43/25; A47J 43/27;
A47J 43/042; A47J 43/044; A47J 43/046;
A47J 43/075; A47J 43/0722; A47J 43/0727;
B01F 3/00; B01F 3/0807; B01F 3/0583;
B01F 13/0059; B01F 13/0064; B02C 1/08;
B02C 2/04; B02C 4/42; B02C 4/142; B02C
4/143; B02C 4/423; B02C 13/1835; B28C
5/10; B28C 5/12; B28C 5/14; B28C 5/16

See application file for complete search history.

(56) **References Cited**

U.S. PATENT DOCUMENTS

D191,153 S *	8/1961	Gresens	241/282.1
3,176,968 A *	4/1965	Appleton	A47J 27/004 219/433
D345,080 S *	3/1994	Piret	D7/376
D385,151 S *	10/1997	Leverrier	D7/384
5,768,978 A *	6/1998	Dorner	A47J 36/165 366/144
D532,251 S *	11/2006	Kassenaar	D7/378
D581,725 S *	12/2008	Wong	D7/376
D638,653 S *	5/2011	Borin	D7/326

(Continued)

Primary Examiner — Ricky Pham

(74) *Attorney, Agent, or Firm* — Collard & Roe, P.C.

(57) **CLAIM**

The ornamental design for a food preparation appliance, as shown and described.

DESCRIPTION

FIG. 1 is a front view of one embodiment of a food preparation appliance, showing our new design;
FIG. 2 is a first side view thereof;
FIG. 3 is a rear view thereof;
FIG. 4 is a second side view thereof, opposite the first side view shown in FIG. 2;
FIG. 5 is a top view thereof;
FIG. 6 is a bottom view thereof;
FIG. 7 is a front, first side and top perspective view thereof;
FIG. 8 is a front view of another embodiment of a food preparation appliance, showing our new design;
FIG. 9 is a first side view thereof;
FIG. 10 is a rear view thereof;
FIG. 11 is a second side view thereof, opposite the first side view shown in FIG. 9;
FIG. 12 is a top view thereof;
FIG. 13 is a bottom view thereof; and,
FIG. 14 is a front, first side and top perspective view thereof.

1 Claim, 14 Drawing Sheets

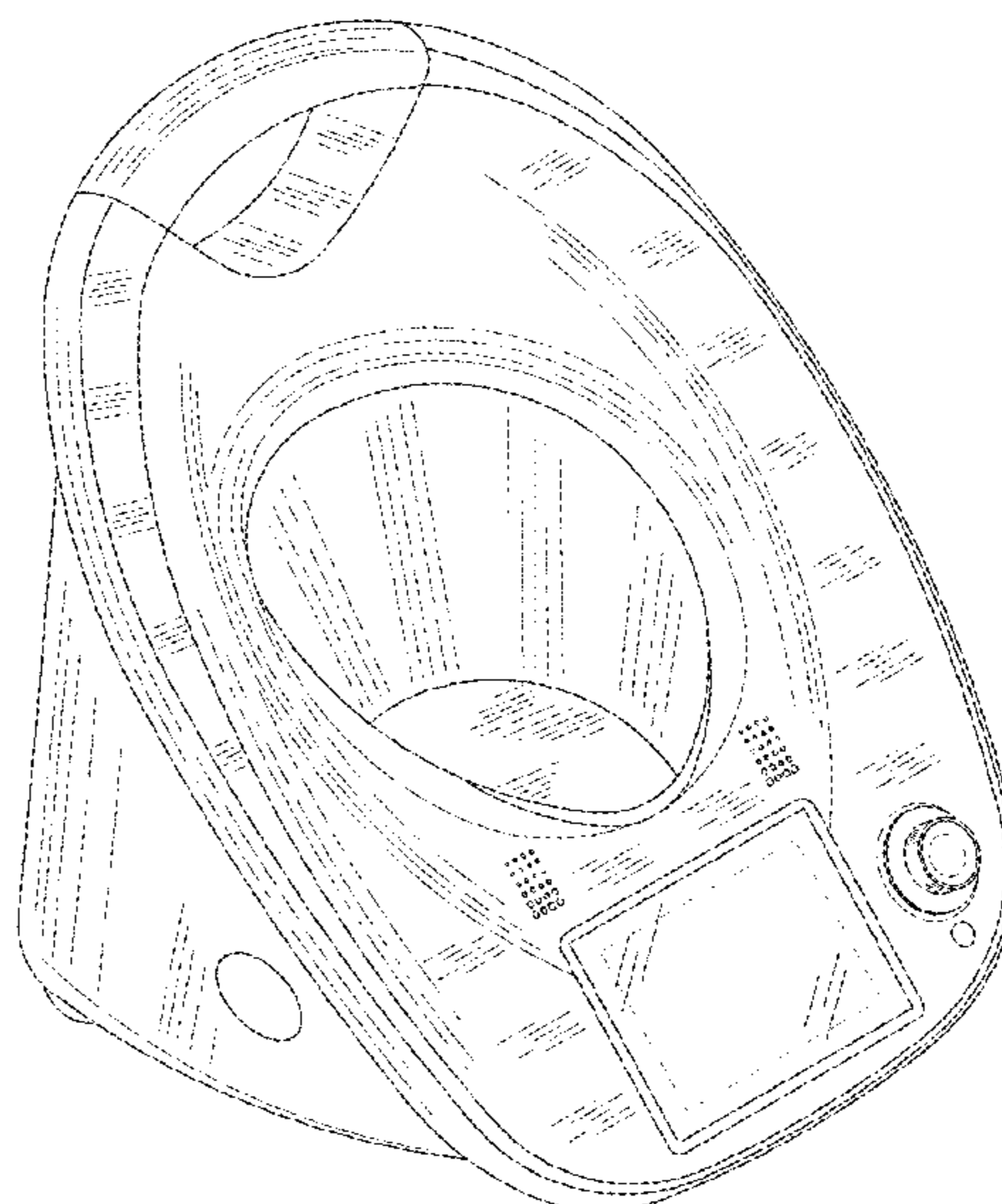
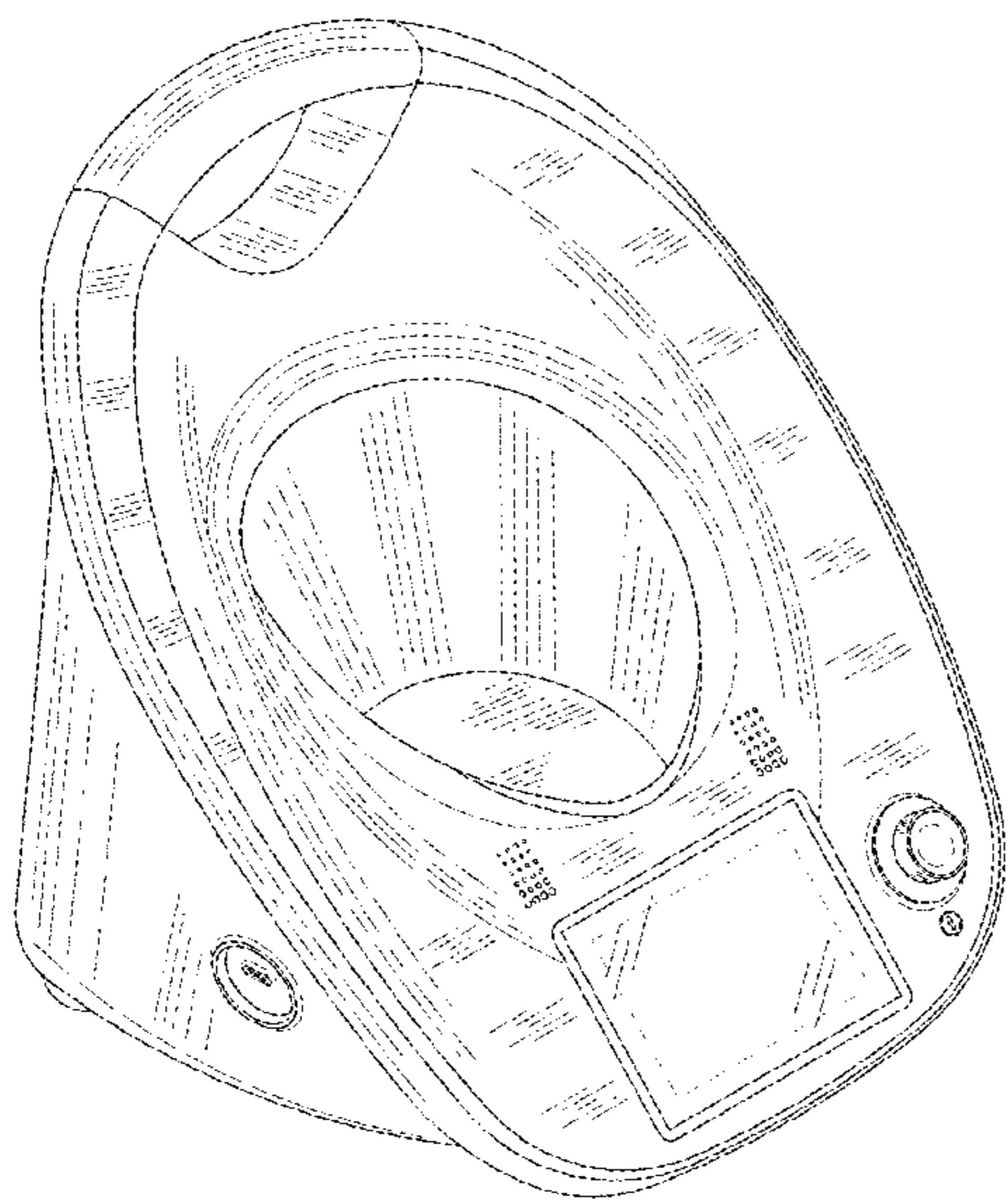

US D772,001 S

Page 2

(56)

References Cited

U.S. PATENT DOCUMENTS

D745,316 S	*	12/2015	Usmar	D7/376	
D747,917 S	*	1/2016	Kemker	D7/376	* cited by examiner
D751,857 S	*	3/2016	Kemker	D7/376	
D757,485 S	*	5/2016	Benoit	D7/376	
2002/0027175 A1	*	3/2002	Capp	A47J 43/046 241/199.12	

Fig. 1

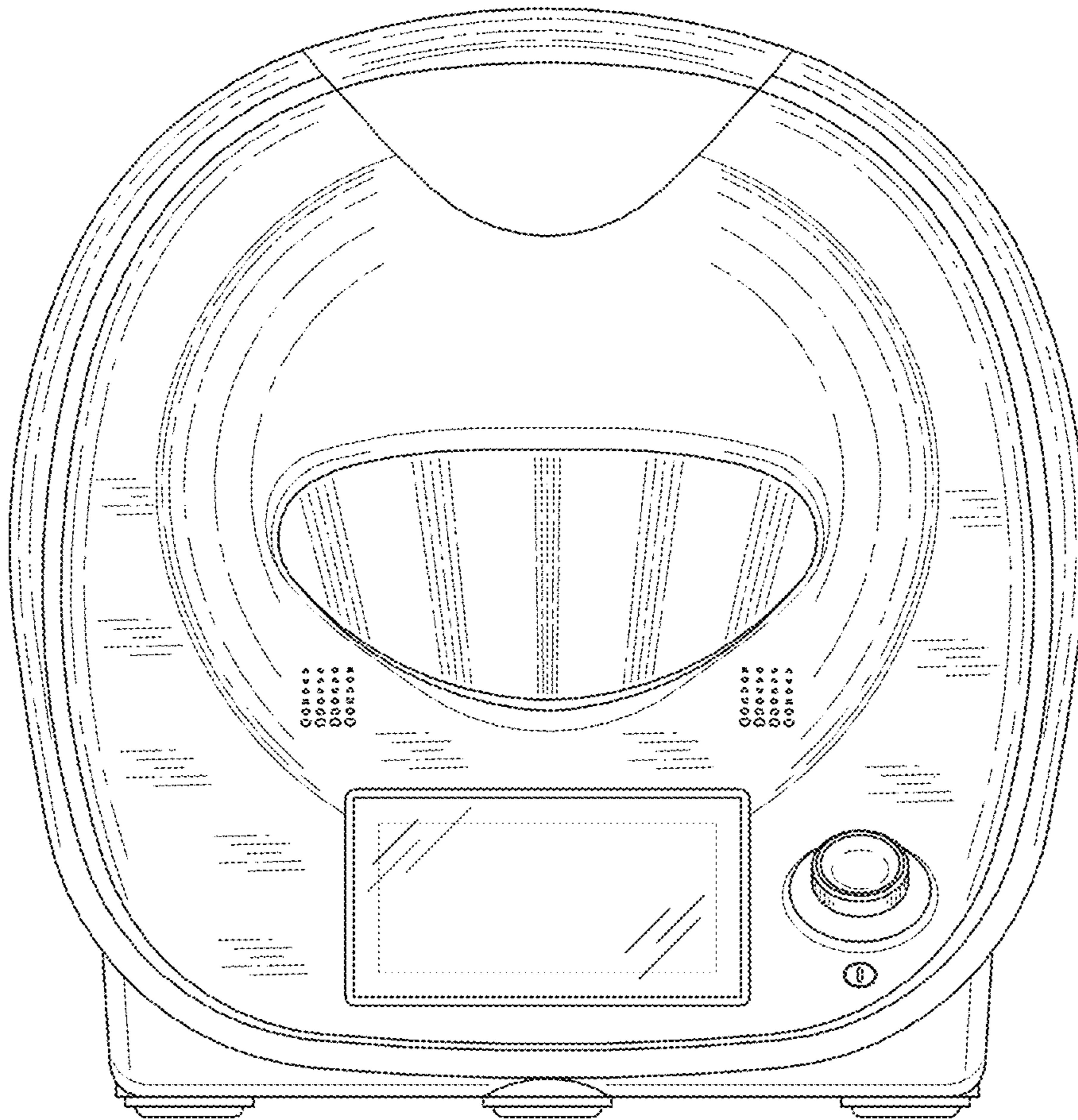

Fig. 2

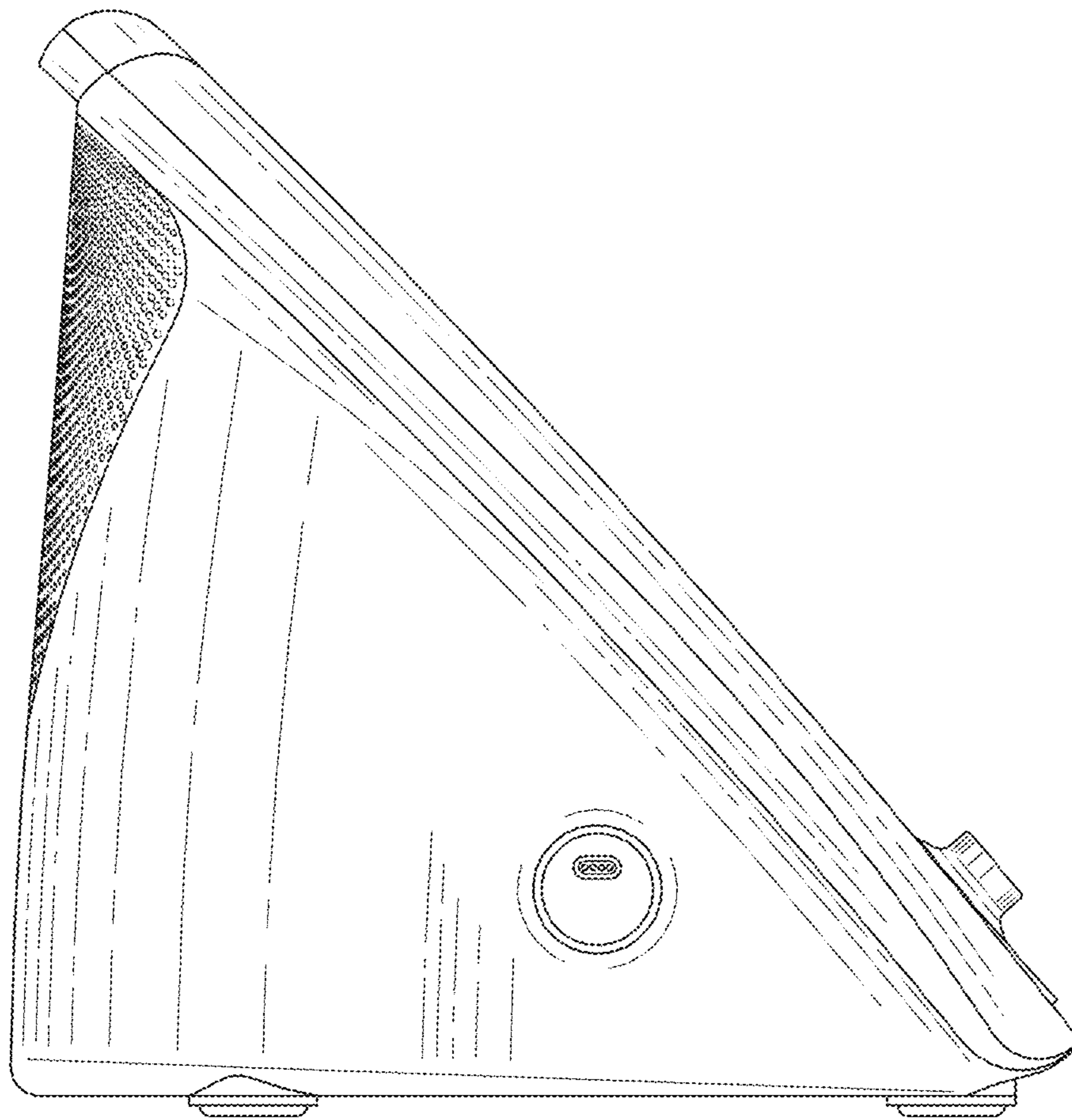

Fig. 3

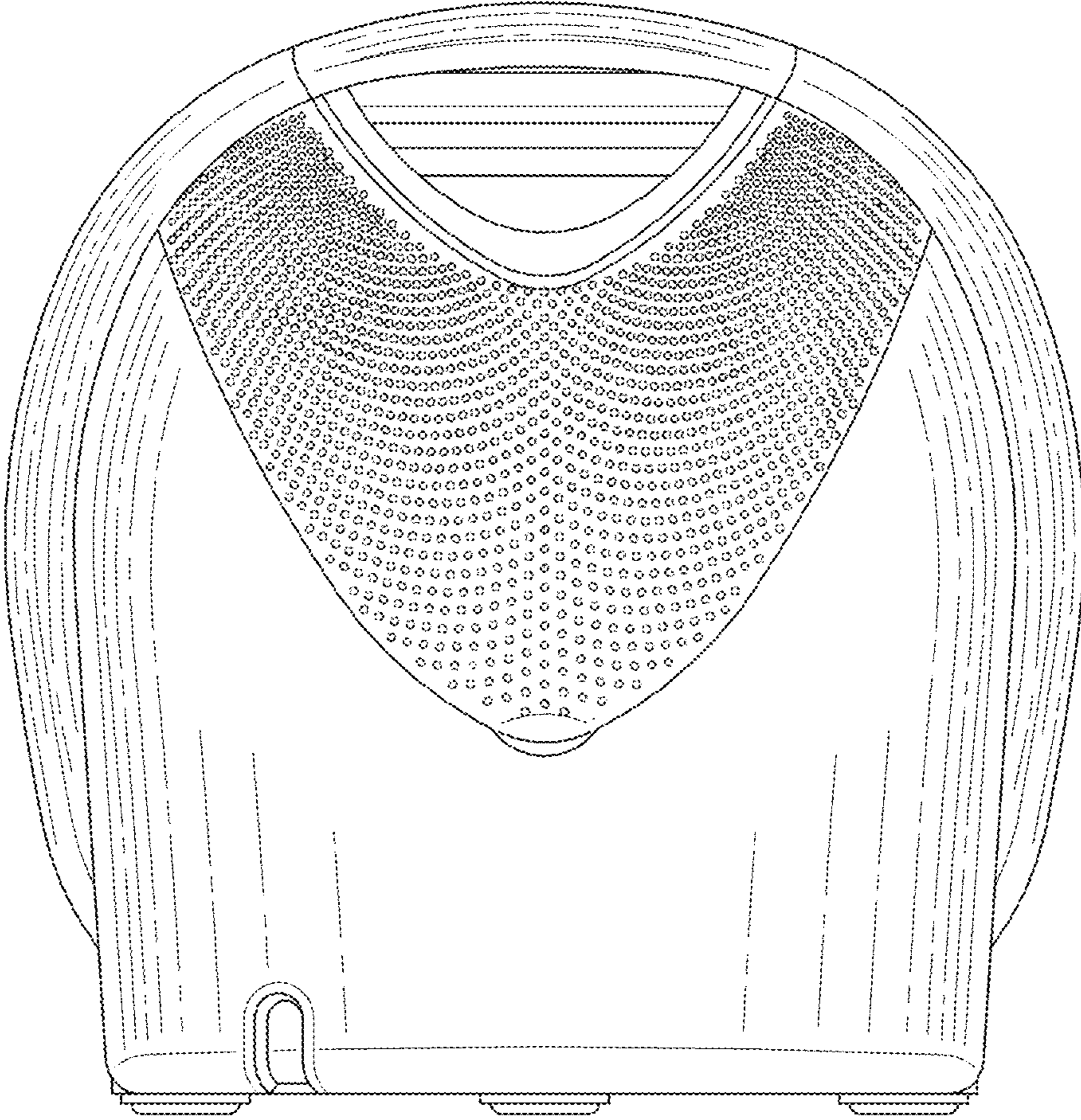

Fig. 4

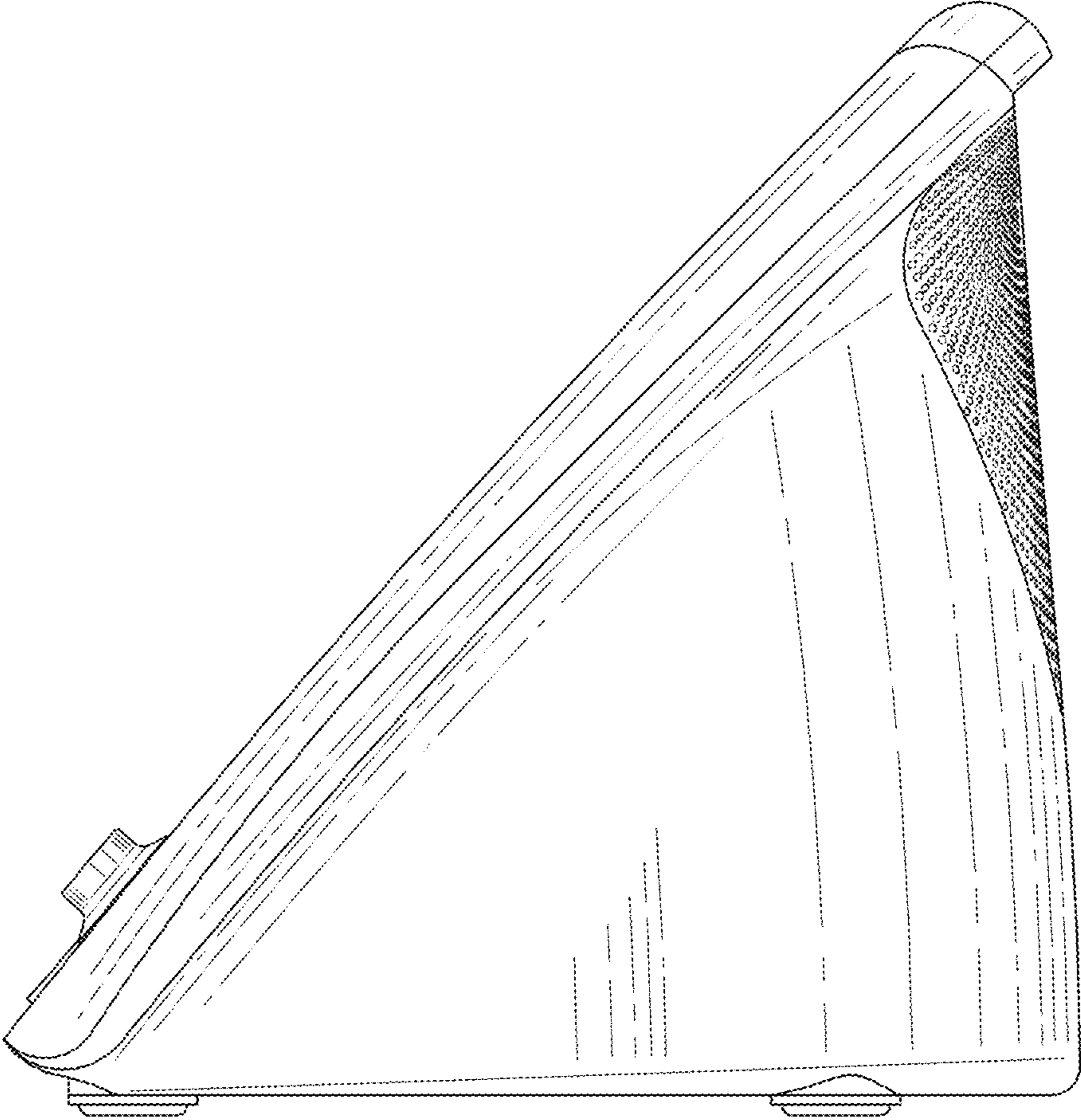

Fig. 5

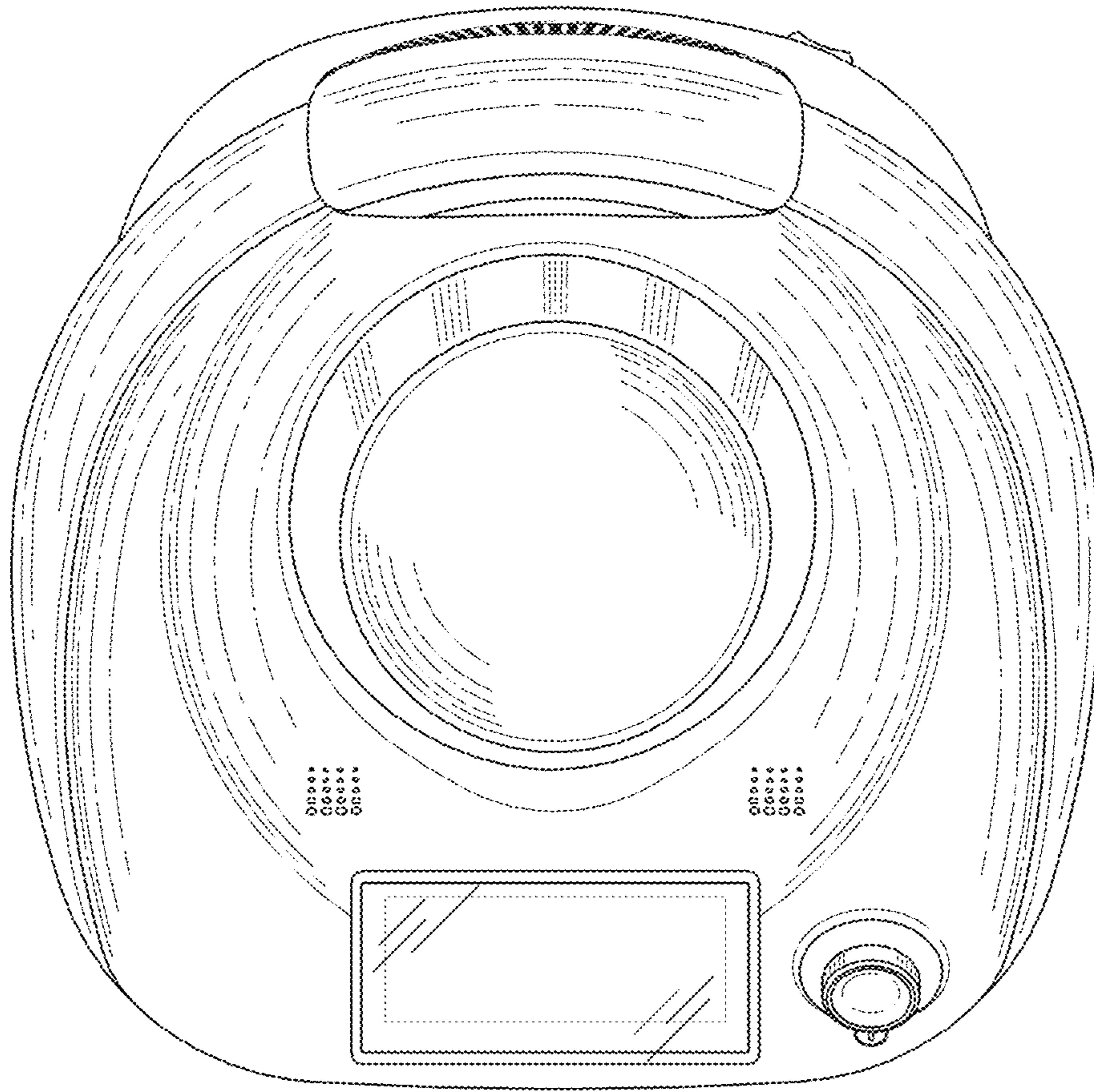

Fig. 6

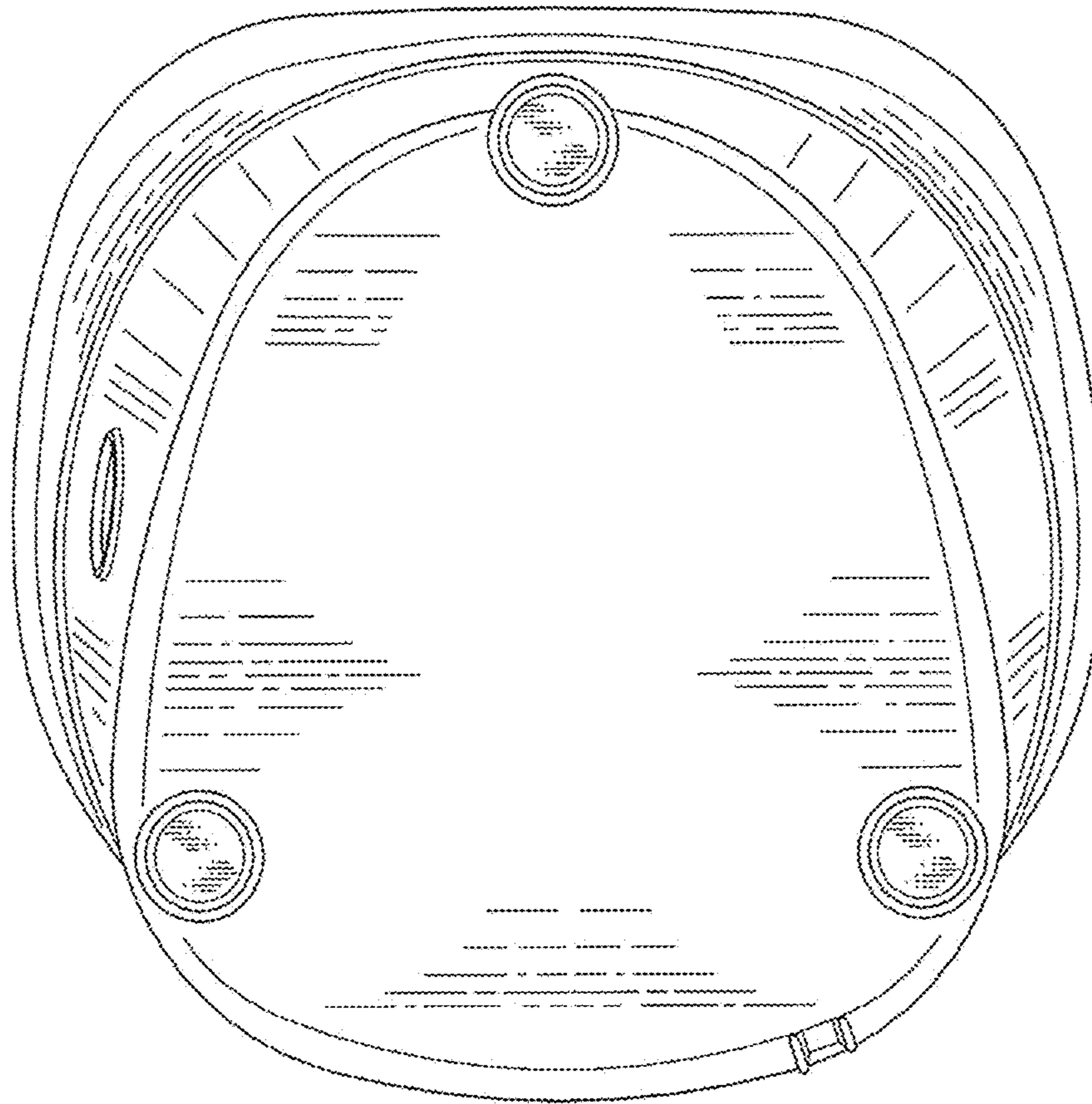

Fig. 7

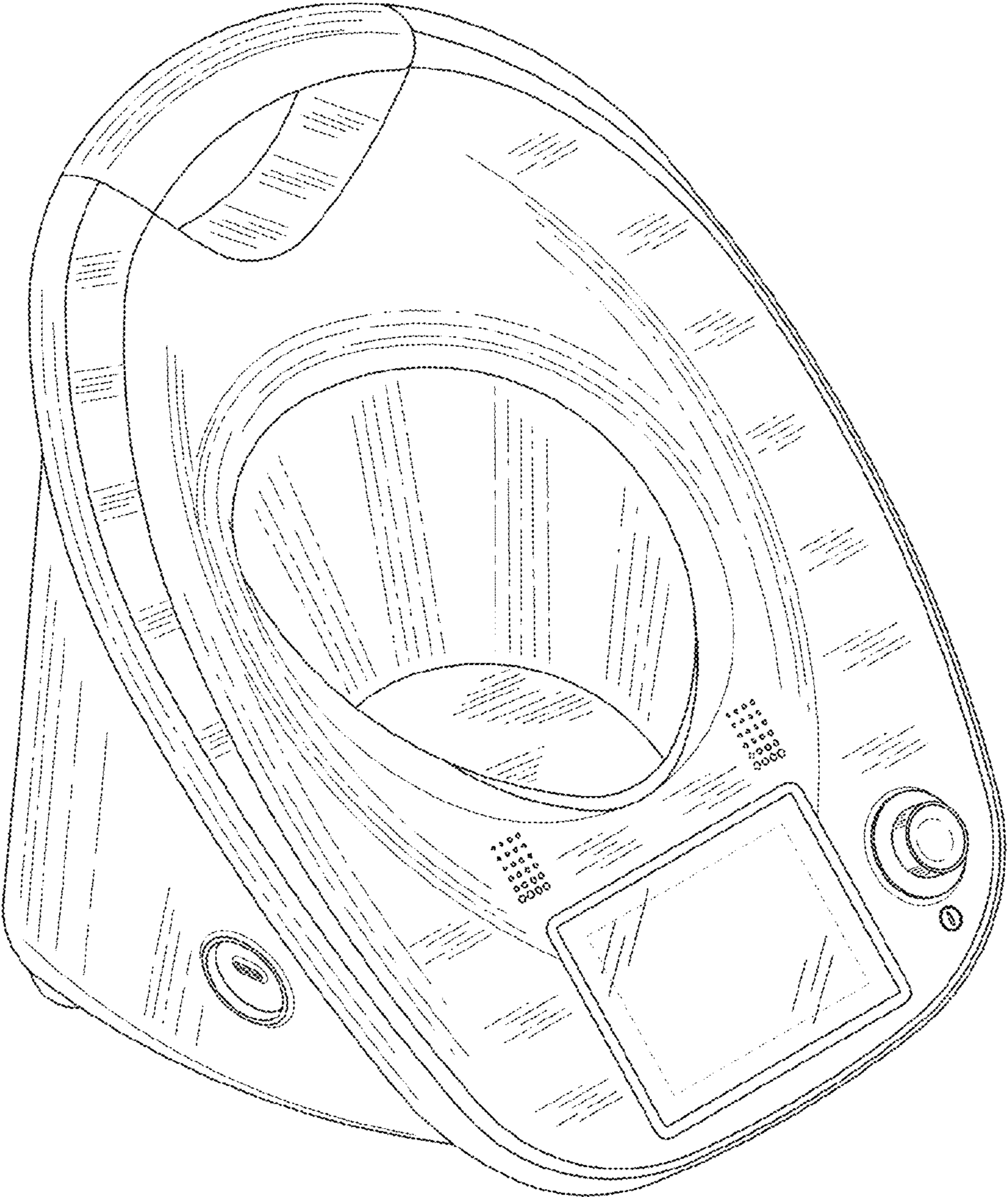

Fig. A

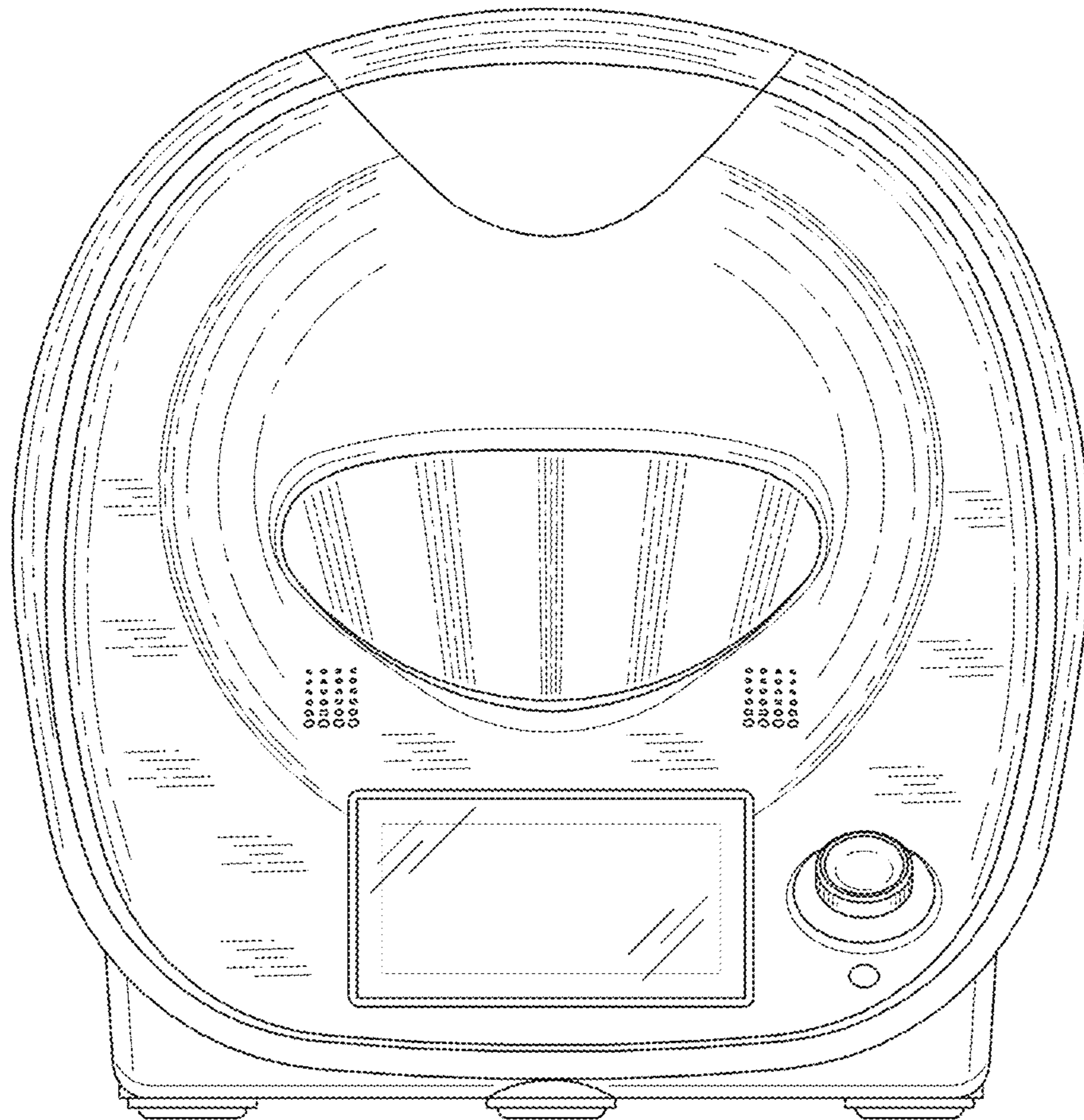

Fig. 9

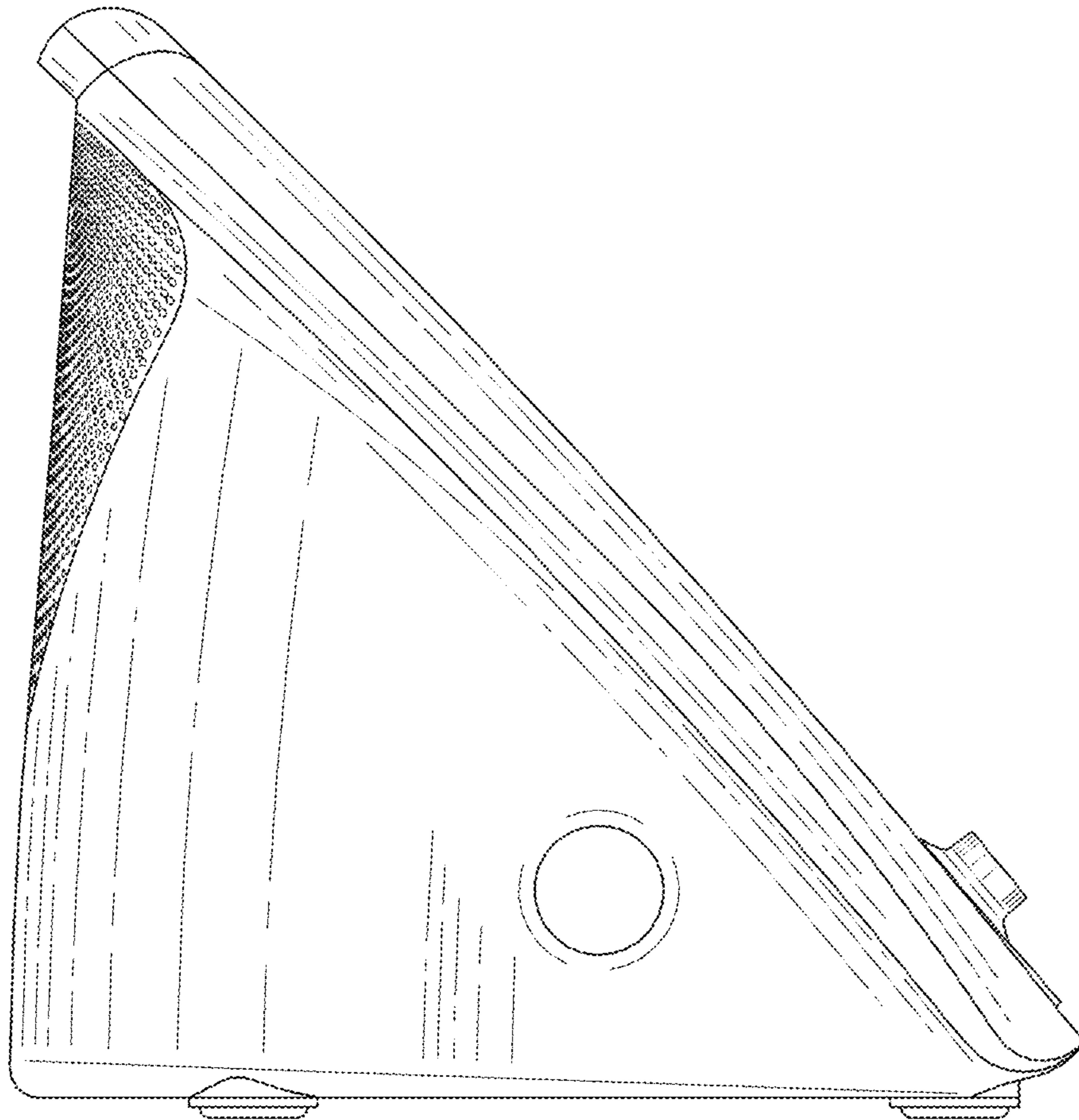

Fig. 10

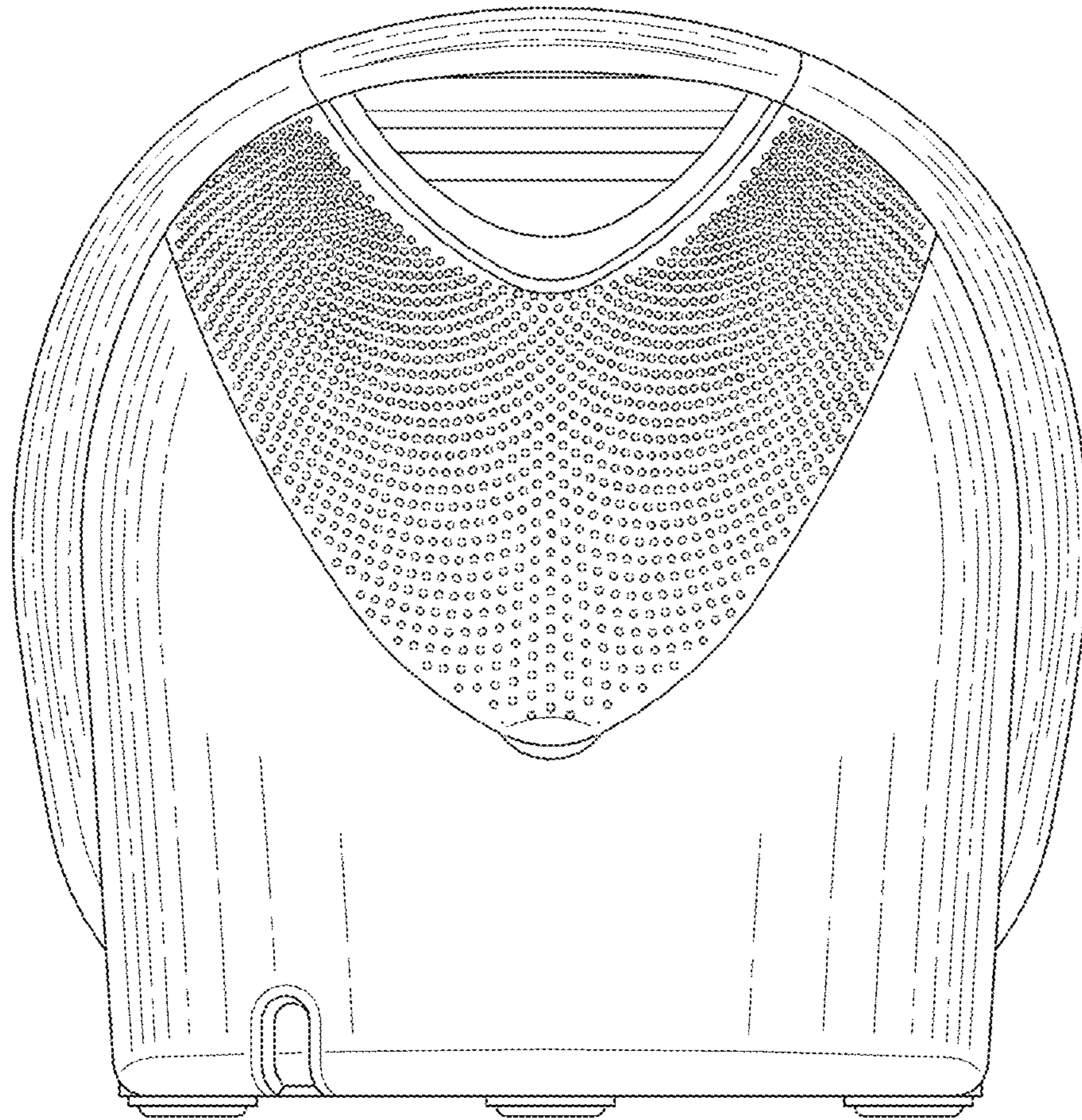

Fig. 11

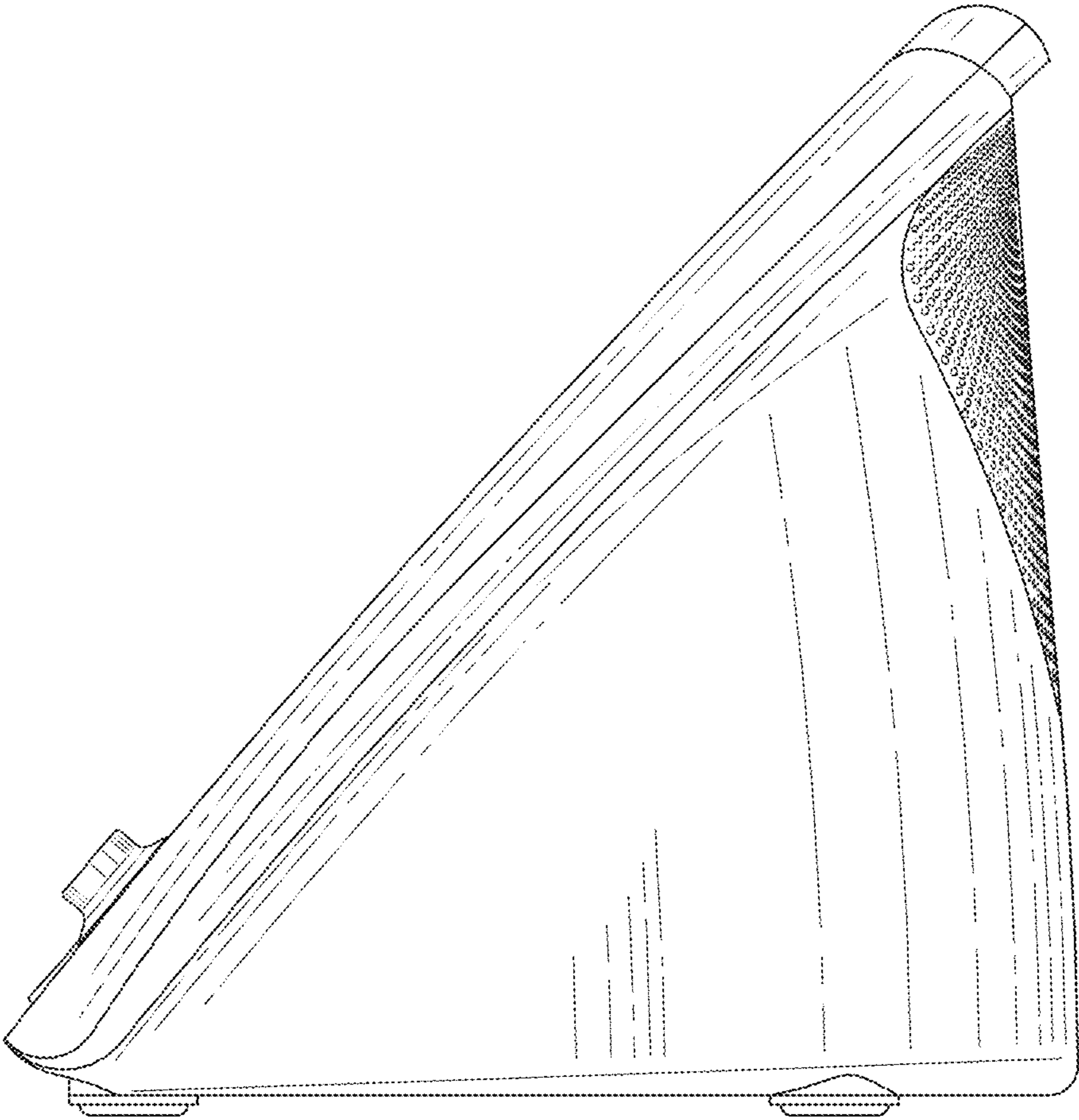

Fig. 12

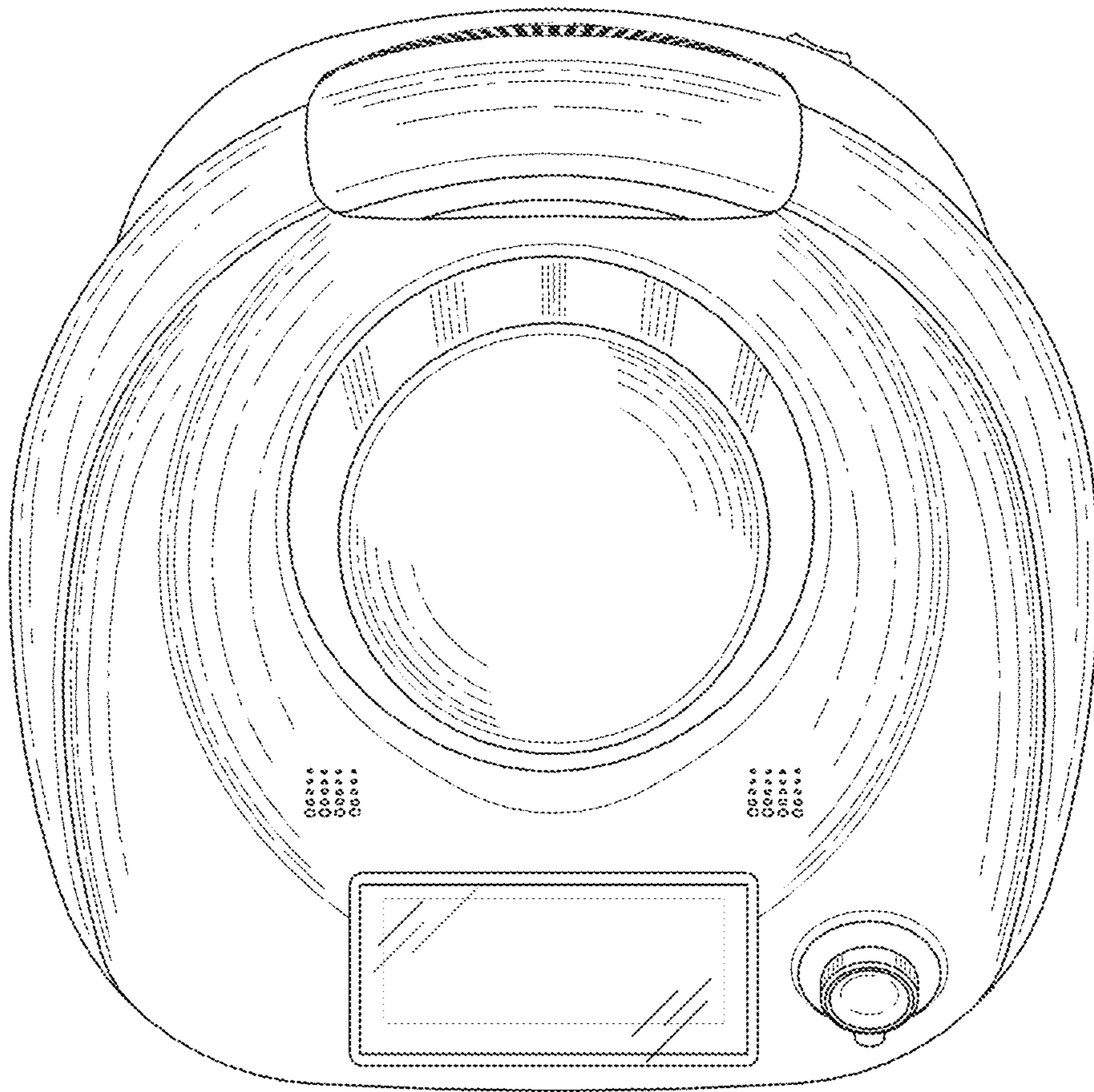

Fig. 13

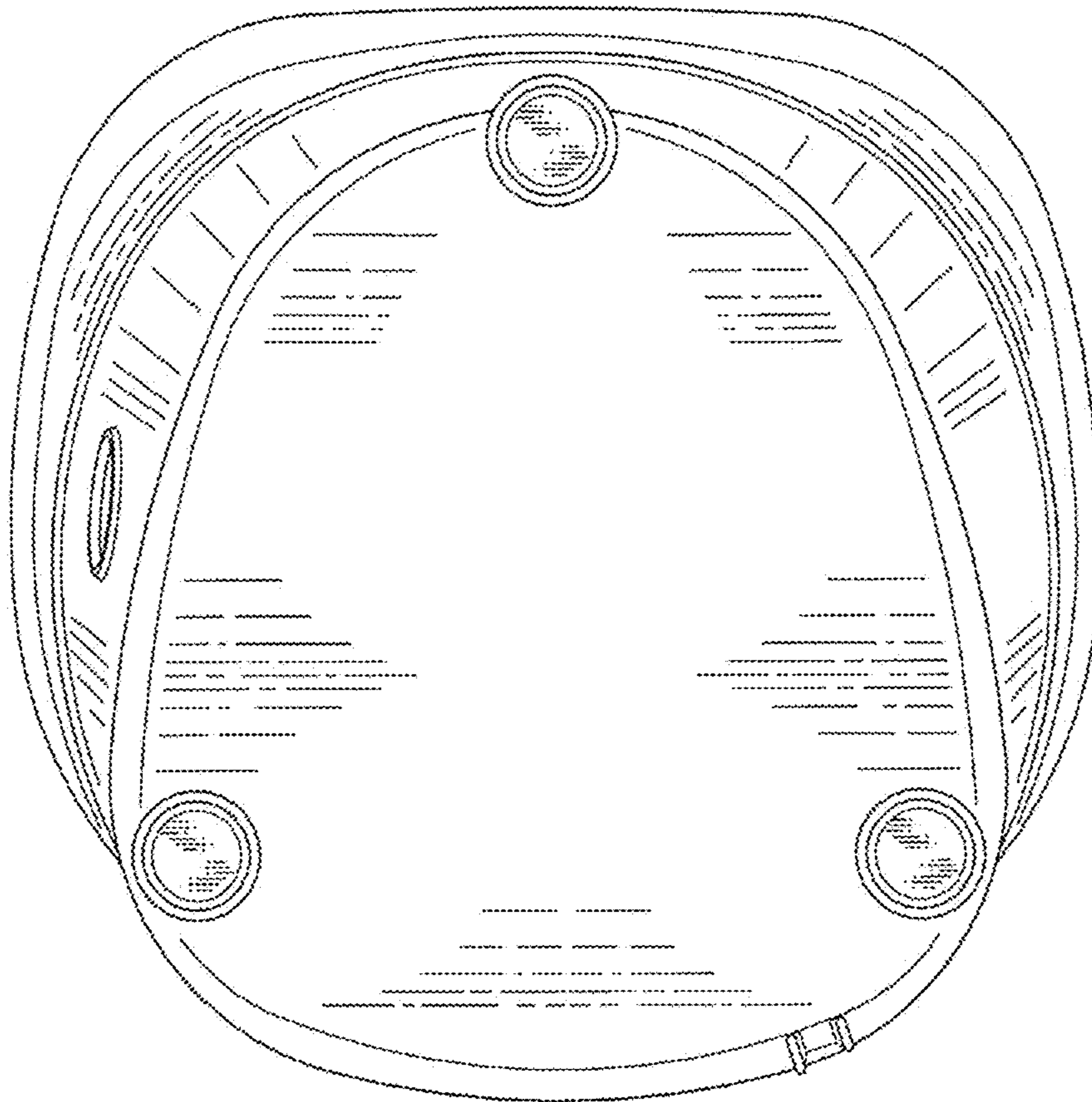

Fig. 14

