



US00D771918S

(12) **United States Design Patent** (10) **Patent No.:** **US D771,918 S**
Engerman (45) **Date of Patent:** **** Nov. 22, 2016**

- (54) **FOOTWEAR**
- (71) Applicant: **Crocs, Inc.**, Niwot, CO (US)
- (72) Inventor: **Danielle Engerman**, Denver, CO (US)
- (73) Assignee: **CROCS, INC.**, Niwot, CO (US)
- (**) Term: **15 Years**
- (21) Appl. No.: **29/538,191**
- (22) Filed: **Sep. 1, 2015**

D479,034 S 9/2003 Tzenos
 D479,906 S 9/2003 Hawker et al.
 D493,611 S * 8/2004 Chen D2/969

(Continued)

FOREIGN PATENT DOCUMENTS

CN ZL200830004737 4/2009
 CN ZL201130336894 7/2012

(Continued)

OTHER PUBLICATIONS

Adidas Superstar 2.0 Shoes [online] retrieved on Oct. 9, 2013, retrieved from <http://www.adidas.com/us/product/mens-originals-superstar-20-shoes/E-U021>(shoe available more than one year prior to the filing date of the present application).

(Continued)

Primary Examiner — Ian Simmons
Assistant Examiner — Rashida C Walshon
 (74) *Attorney, Agent, or Firm* — Wilmer Cutler Pickering Hale and Dorr LLP

Related U.S. Application Data

- (63) Continuation of application No. 29/502,893, filed on Sep. 19, 2014.
- (51) **LOC (10) Cl.** **02-04**
- (52) **U.S. Cl.**
USPC **D2/923**; D2/896
- (58) **Field of Classification Search**
USPC D2/896, 900, 914, 916, 917, 923, 92, D2/943, 946-96, 969, 972; 36/45, 8, 100, 36/88, 102, 112, 113, 3 A, 3 R, 7.4, 11.5, 4, 36/87, 7.5, 25 R
CPC A43B 1/0081; A43B 1/14; A43B 3/0042; A43B 7/06; A43B 7/08
See application file for complete search history.

- (57) **CLAIM**
The ornamental design for footwear, as shown and described.

DESCRIPTION

FIG. 1 is a front perspective view of footwear;
 FIG. 2 is a front view thereof;
 FIG. 3 is a back view thereof;
 FIG. 4 is an outer side view thereof;
 FIG. 5 is an inner side view thereof;
 FIG. 6 is a top view thereof; and,
 FIG. 7 is a bottom view thereof.
 The broken line showing is for illustrative purposes only and forms no part of the claimed design.

1 Claim, 7 Drawing Sheets

References Cited

U.S. PATENT DOCUMENTS

D90,234 S	7/1933	Daniels	
D173,699 S	12/1954	Hosker	
D200,846 S	4/1965	Bovay	
D243,421 S	2/1977	Cohen	
D368,797 S *	4/1996	Brooks	D2/909
D404,544 S *	1/1999	Tzenos	D2/909
D414,018 S *	9/1999	Cook	D2/910
D428,240 S	7/2000	Hoyt et al.	
D473,040 S	4/2003	Hawker et al.	
D476,797 S	7/2003	Schenone	

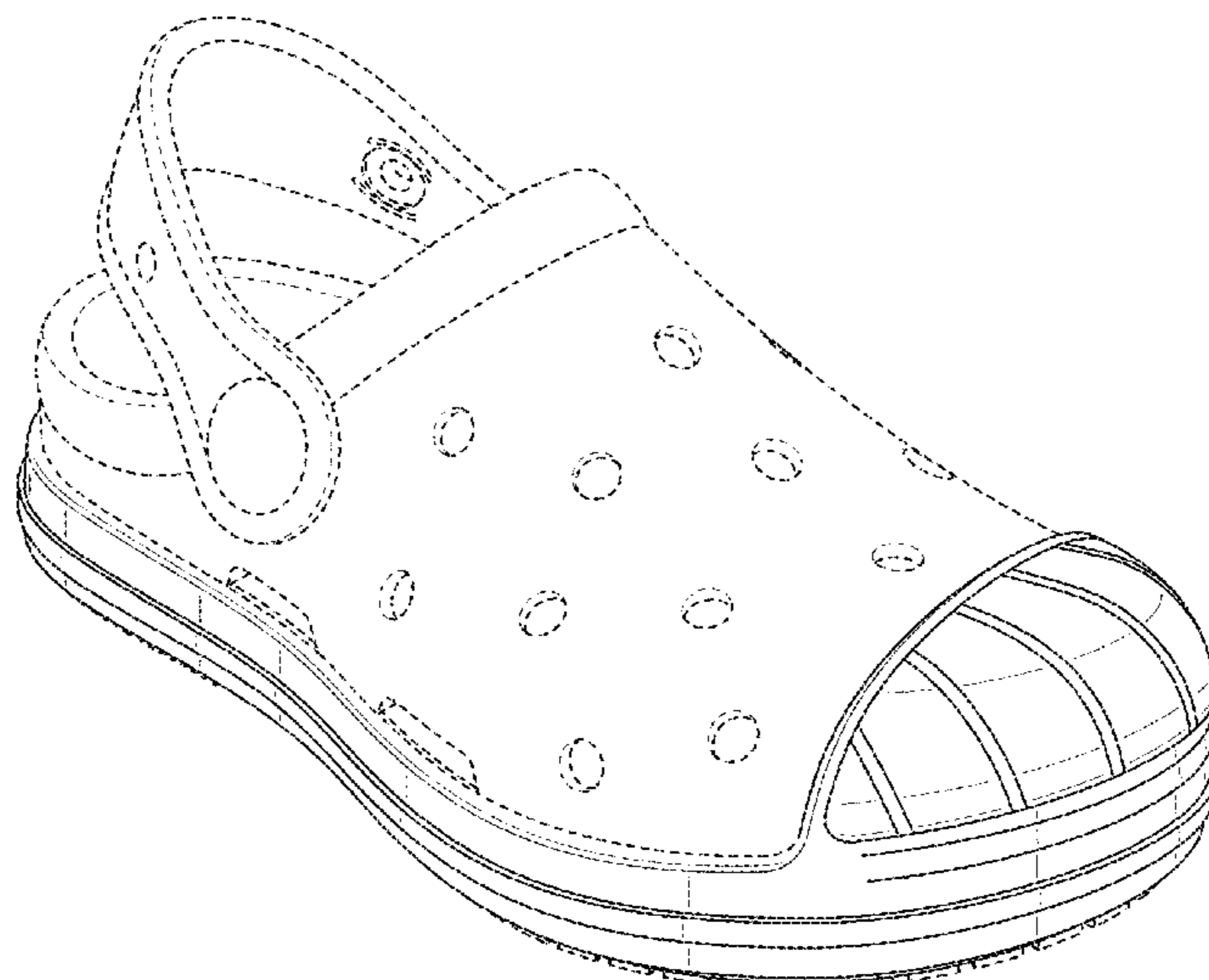

(56)

References Cited

U.S. PATENT DOCUMENTS

D498,901 S 11/2004 Hawker et al.
 D499,875 S 12/2004 Lozano
 D513,858 S 1/2006 O'Connor
 6,993,858 B2 2/2006 Seamans
 D517,788 S 3/2006 Seamans
 D517,789 S 3/2006 Seamans
 D517,790 S 3/2006 Seamans
 D523,614 S 6/2006 Mitchell
 D523,615 S 6/2006 Burg
 D525,419 S 7/2006 Seamans
 D529,263 S 10/2006 Wolf
 7,146,751 B2 12/2006 Seamans
 D535,088 S 1/2007 Seamans
 D543,341 S 5/2007 Seamans
 D543,681 S 6/2007 McCarthy
 D545,032 S 6/2007 Wolf
 D545,033 S 6/2007 Wolf
 D549,434 S 8/2007 Seamans
 D550,441 S 9/2007 Seamans
 D561,982 S 2/2008 Hoyt
 D563,082 S 3/2008 Seamans
 D564,204 S 3/2008 Seamans
 D564,205 S 3/2008 Seamans
 D564,206 S 3/2008 Seamans
 D564,207 S 3/2008 Seamans
 D564,208 S 3/2008 Seamans
 D564,420 S 3/2008 Devlin
 D564,743 S 3/2008 Seamans
 D564,749 S 3/2008 Seamans
 D567,482 S 4/2008 Hoyt
 D567,483 S 4/2008 Liow
 D573,778 S 7/2008 Hawker
 D575,480 S 8/2008 Zimmerman
 D575,937 S 9/2008 Klavano
 D578,743 S 10/2008 Liow
 D579,182 S 10/2008 Klavano
 D579,651 S 11/2008 Hearn
 D584,032 S 1/2009 Jarosik
 D584,037 S 1/2009 del Biondi et al.
 D590,588 S 4/2009 del Biondi et al.
 D593,287 S 6/2009 Del Biondi et al.
 D599,538 S 9/2009 del Biondi et al.
 D600,907 S 9/2009 Boyd et al.
 D602,243 S 10/2009 Bradford
 D610,784 S 3/2010 Del Biondi
 D618,897 S 7/2010 Liles
 D624,248 S 9/2010 Deitch
 D624,733 S 10/2010 O'Boyle et al.
 D632,465 S 2/2011 del Biondi et al.
 D637,382 S 5/2011 Bathum
 D642,773 S 8/2011 Liow
 8,033,034 B2 10/2011 Jarosik
 D648,105 S 11/2011 Schlageter et al.
 D651,387 S 1/2012 Van Zyll De Jong et al.
 D651,388 S 1/2012 Van Zyll De Jong et al.
 D651,390 S 1/2012 Van Zyll De Jong et al.
 D653,020 S 1/2012 Van Zyll De Jong et al.
 D659,953 S 5/2012 Van Zyll De Jong et al.
 D666,798 S 9/2012 Now

D667,612 S 9/2012 Del Biondi et al.
 D675,418 S 2/2013 Van Zyll De Jong et al.
 D677,865 S 3/2013 Van Zyll De Jong et al.
 D683,940 S 6/2013 Del Biondi
 D691,351 S 10/2013 Pugazhenth
 D698,131 S 1/2014 Del Biondi et al.
 D698,133 S 1/2014 Callegarini et al.
 D698,531 S 2/2014 Lock et al.
 D708,827 S 7/2014 Kue
 D718,518 S 12/2014 Del Biondi et al.
 D722,747 S 2/2015 Kue
 D726,397 S 4/2015 Del Biondi et al.
 D728,204 S 5/2015 Fongher
 D731,157 S 6/2015 Fongher
 D732,808 S 6/2015 Del Biondi et al.
 2004/0231189 A1 11/2004 Seamans
 2004/0231190 A1 11/2004 Seamans
 2004/0231191 A1 11/2004 Seamans
 2006/0048407 A1 3/2006 Seamans
 2007/0130797 A1 6/2007 Seamans

FOREIGN PATENT DOCUMENTS

CN ZL201330192247 11/2013
 CN ZL201430021510 6/2014
 EM 0000611220001 8/2003
 GB 2322286 A 8/1998
 WO WO-2004105531 A1 12/2004
 WO WO-2004105534 A2 12/2004

OTHER PUBLICATIONS

Buddy by Calzuro: A New Born in the Calzuro's Family, <http://www.calzuro.it/news.php?lang=en&id=20> (May 13, 2009) (6 pages).
 Crocs: Cayman, <http://www.crocs.com/crocs-cayman/10001.default.pd.html?g=cayman> (Nov. 3, 2009) (6 pages).
 Design U.S. Appl. No. 29/477,445, entitled Footwear, filed Dec. 21, 2013.
 Design U.S. Appl. No. 29/485,886, entitled Footwear, filed Mar. 24, 2014.
 Design U.S. Appl. No. 29/502,839, entitled Footwear, filed Sep. 19, 2014.
 Design U.S. Appl. No. 29/502,892, entitled Footwear, filed Sep. 19, 2014.
 Design U.S. Appl. No. 29/502,893, entitled Footwear, filed Sep. 19, 2014.
 Design U.S. Appl. No. 29/502,896, entitled Footwear, filed Sep. 19, 2014.
 Design U.S. Appl. No. 29/502,897, entitled Footwear, filed Sep. 19, 2014.
 Design U.S. Appl. No. 29/516,918, entitled Footwear, filed Feb. 6, 2015.
 Design U.S. Appl. No. 29/516,922, entitled Footwear, filed Feb. 6, 2015.
 Design U.S. Appl. No. 29/516,919, entitled Footwear, filed Feb. 6, 2015.

* cited by examiner

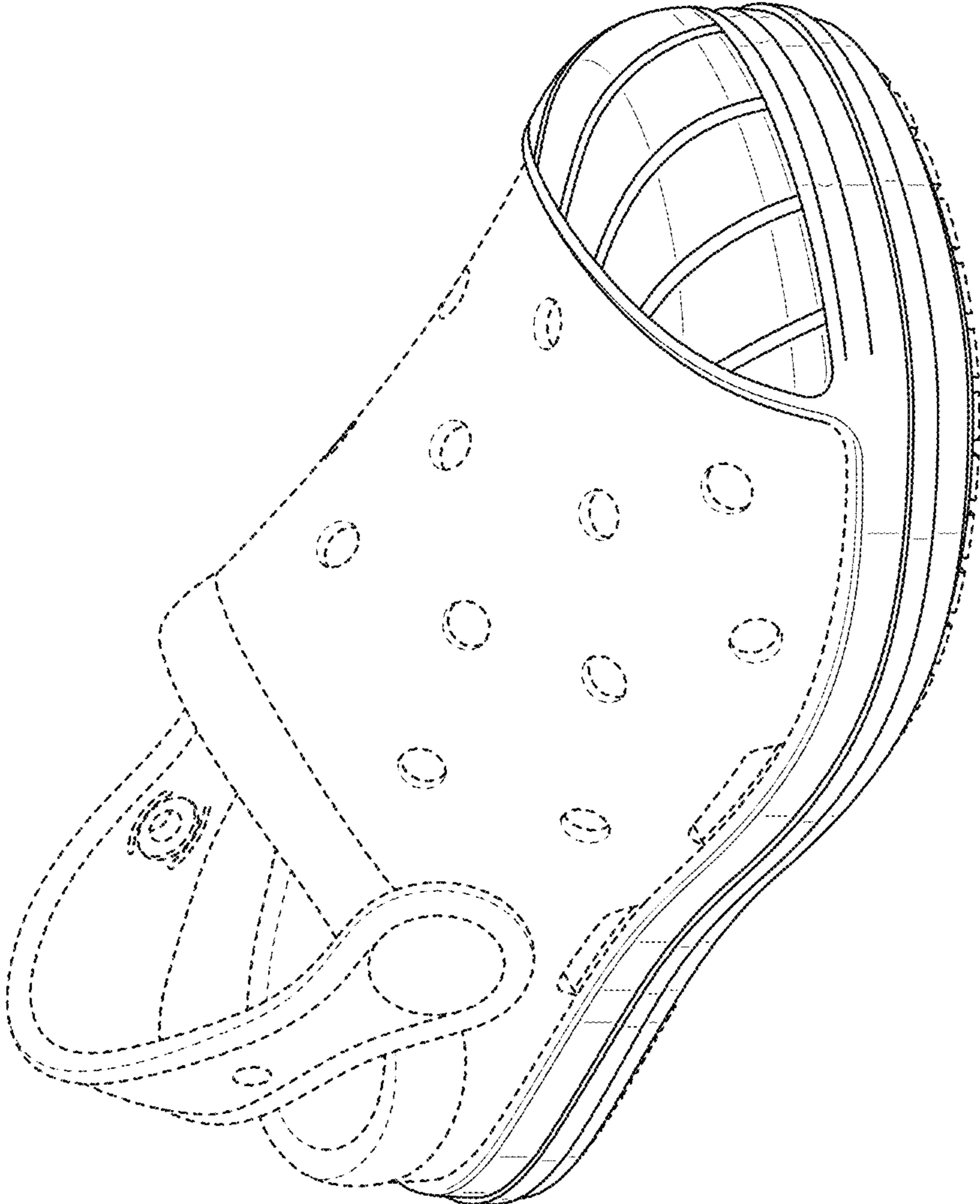

FIG. 1

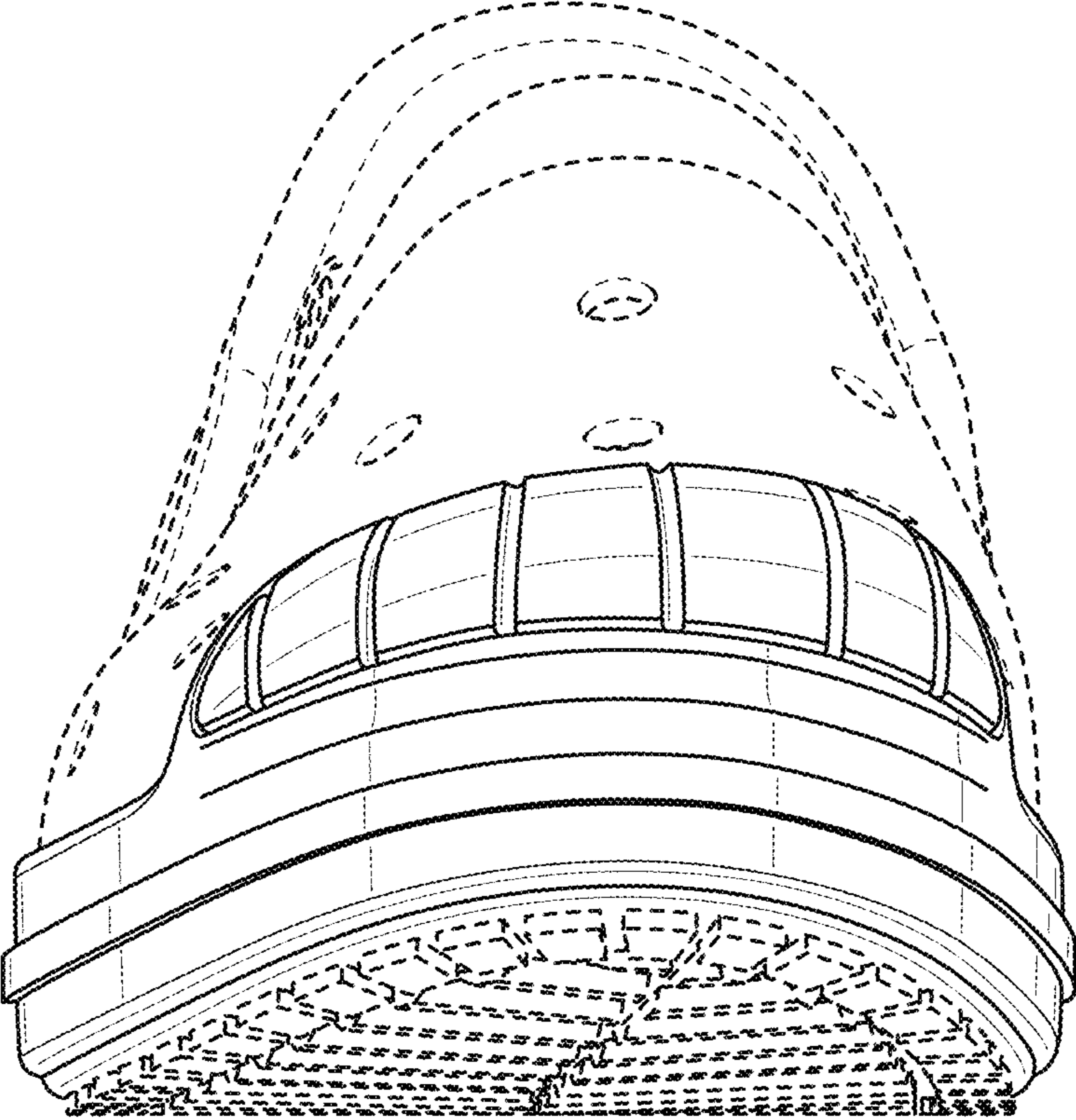

FIG. 2

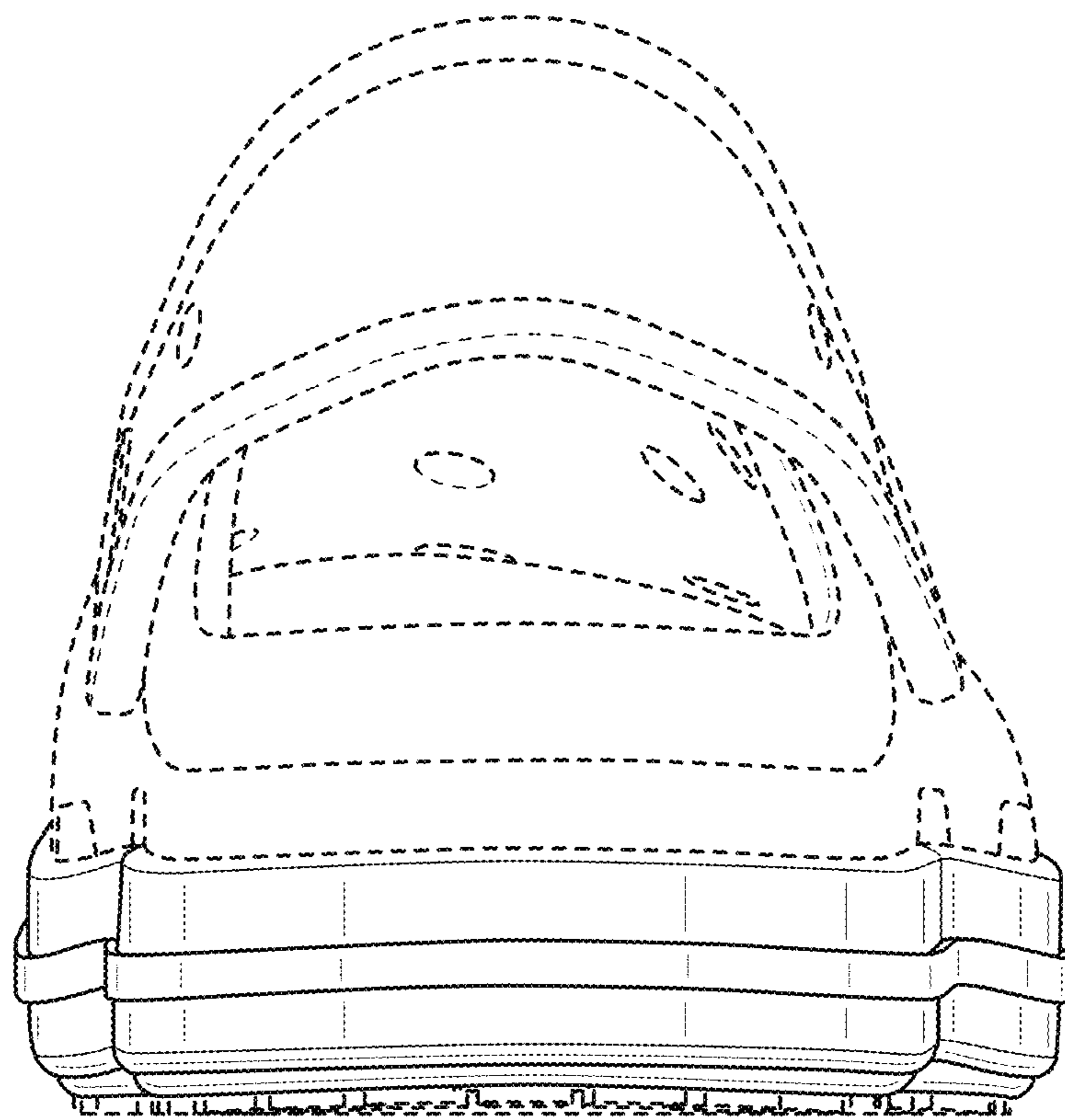

FIG. 3

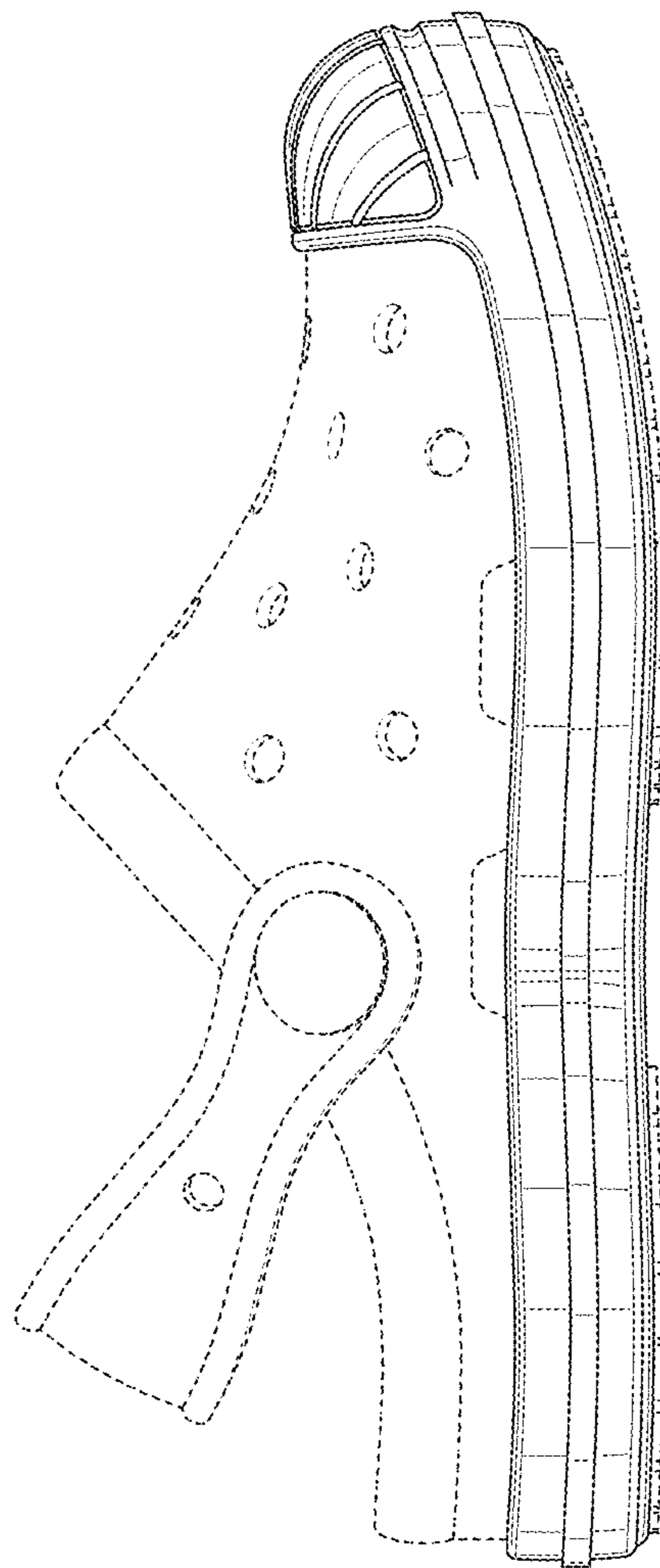

FIG. 4

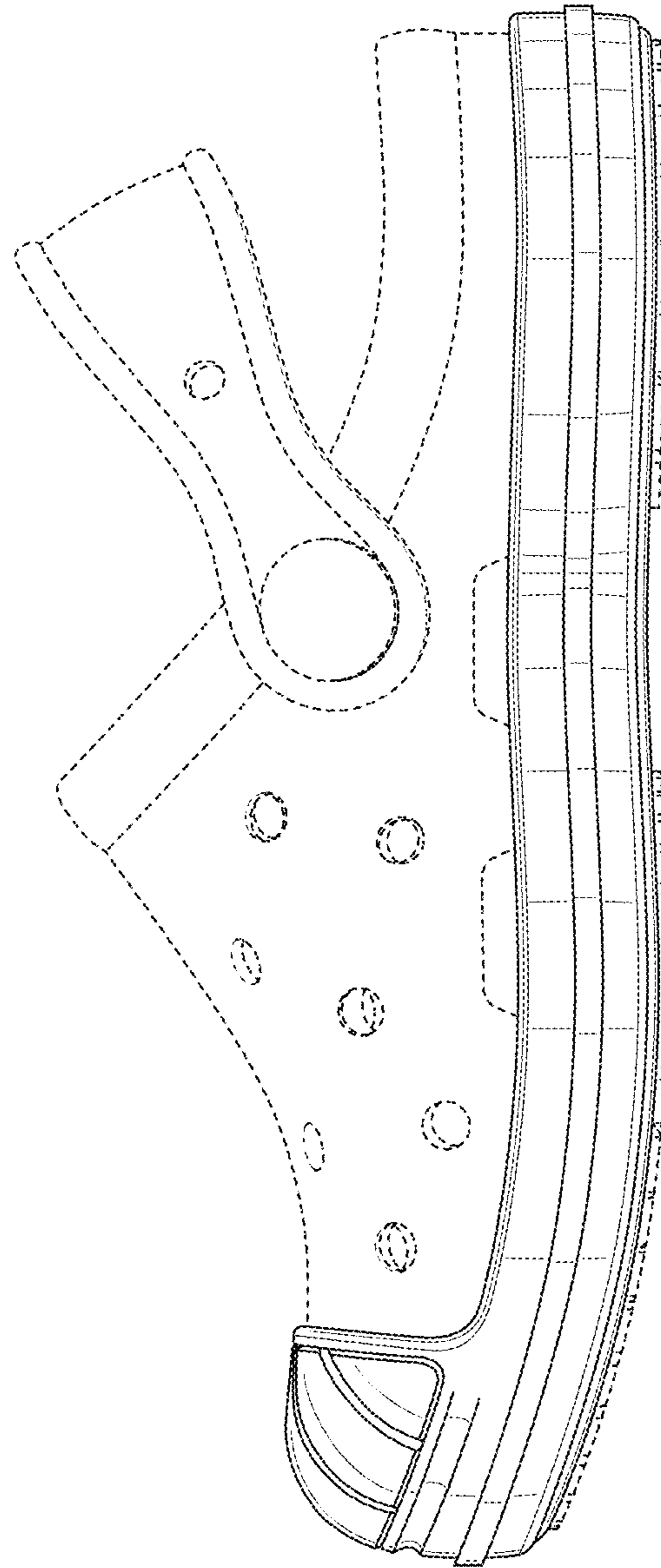

FIG. 5

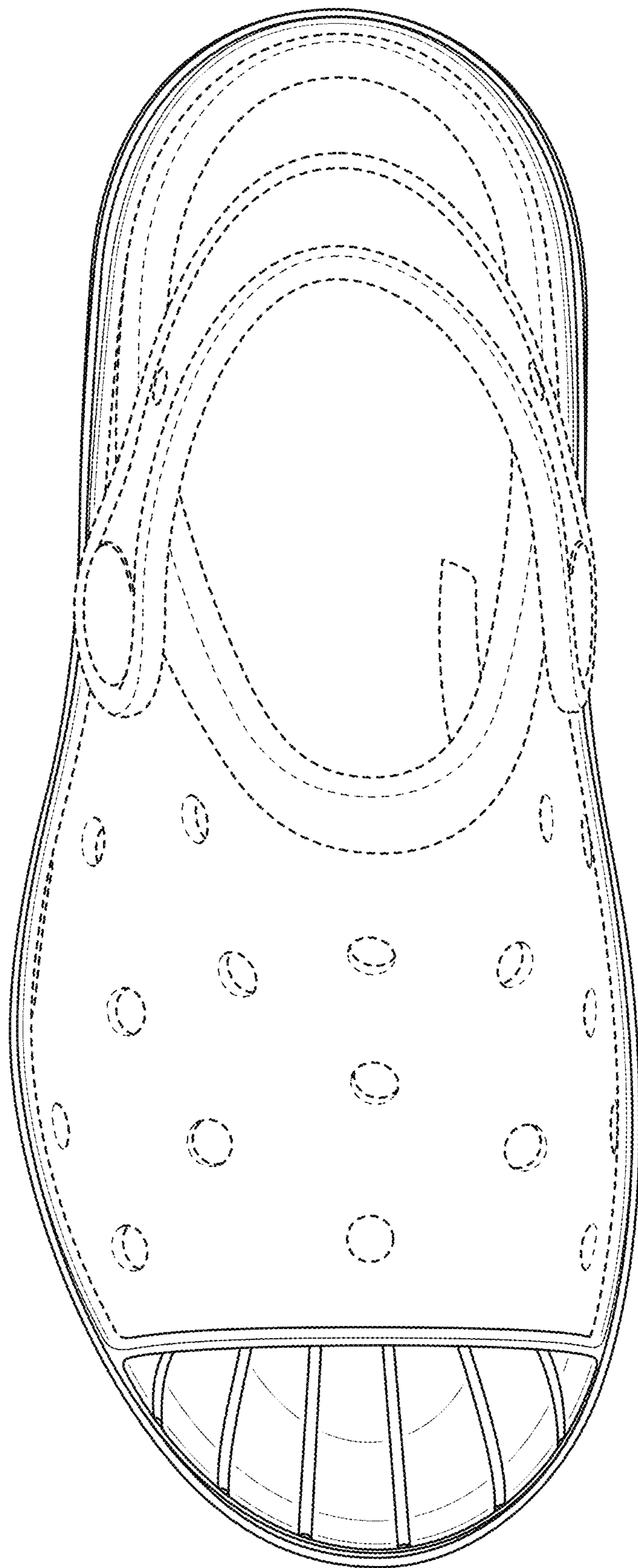

FIG. 6

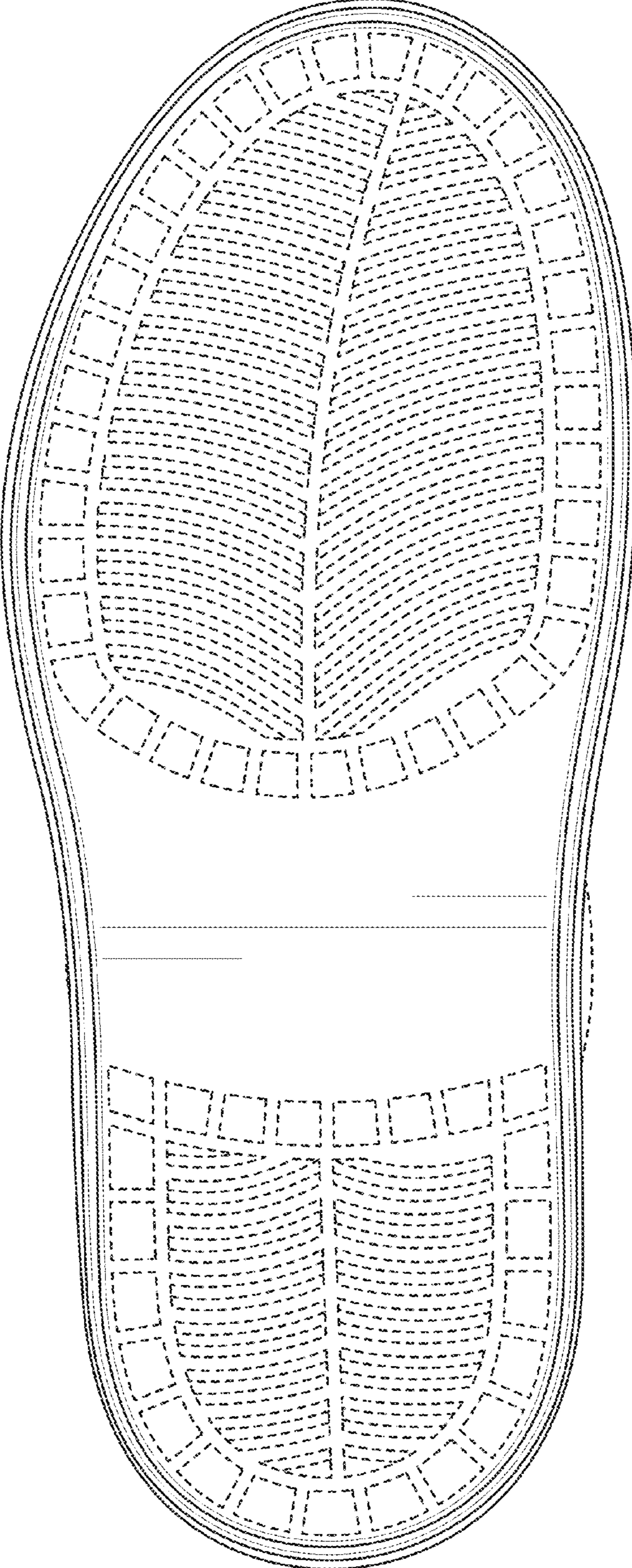

FIG. 7