



US00D771872S

(12) **United States Design Patent** (10) **Patent No.:** **US D771,872 S**  
**Butler et al.** (45) **Date of Patent:** **\*\* Nov. 15, 2016**

(54) <b>ATTACHMENT FOR A NAIL CARE INSTRUMENT</b>	D308,584 S * 6/1990 Sells ..... D28/57
	4,940,136 A * 7/1990 Miller ..... A45D 29/02
	132/75
(71) Applicant: <b>Reckitt Benckiser (Brands) Limited, Slough (GB)</b>	D318,248 S * 7/1991 Samaras ..... D11/26
	D329,923 S * 9/1992 Thaxton ..... D28/56
	D339,656 S * 9/1993 Paladino ..... D28/56
	D347,296 S * 5/1994 Adelman ..... D28/60
(72) Inventors: <b>Martin Butler, Kwun Tong (HK); Fiona Jones, Slough (GB); Darren Morgan, Slough (GB); Maartje Pel, Warwick (GB); Victoria Perrin, Hull (GB); Jackie Tsang, Tin Shui Wai (HK); Simon Woolley, York (GB)</b>	D364,246 S * 11/1995 Conerly ..... D28/60
	5,488,772 A * 2/1996 Dababneh ..... A45D 29/023
	132/75.5
	D391,679 S * 3/1998 Harrison ..... D28/62
	D394,158 S * 5/1998 Kramer ..... D4/113
	D394,731 S * 5/1998 Lee ..... D28/60
	5,924,567 A * 7/1999 Wenum ..... A46B 17/04
	206/15.3

(73) Assignee: **RECKITT BENCKISER (BRANDS) LIMITED, Berkshire (GB)**

(Continued)

(\*\*) Term: **15 Years**

*Primary Examiner* — John Windmuller

*Assistant Examiner* — Steven Czyz

(21) Appl. No.: **29/534,907**

(74) *Attorney, Agent, or Firm* — Troutman Sanders LLP; Ryan A. Schneider; Chris N. Davis

(22) Filed: **Jul. 31, 2015**

(30) **Foreign Application Priority Data**

Mar. 5, 2015 (EM) ..... 002646588-0004  
Jul. 13, 2015 (EM) ..... 002735712-0002

(51) **LOC (10) Cl.** ..... **28-03**

(52) **U.S. Cl.**  
USPC ..... **D28/62**

(58) **Field of Classification Search**  
USPC ..... D28/56, 57, 59, 60, 62; D4/113;  
132/200, 73, 73.5, 73.6, 76.4, 75;  
424/61  
CPC ..... A45D 31/00; A45D 29/18; A45D 29/05;  
A45D 29/04; A45D 29/20; A61Q 3/02  
See application file for complete search history.

(56) **References Cited**

**U.S. PATENT DOCUMENTS**

D168,018 S \* 10/1952 Cohn et al. .... D16/130  
D293,510 S \* 1/1988 Rudnick ..... D4/199

(57) **CLAIM**

The ornamental design for an attachment for a nail care instrument, as shown and described.

**DESCRIPTION**

FIG. 1 is a perspective view of an attachment for a nail care instrument of the present invention;  
FIG. 2 is a bottom view of the attachment for a nail care instrument of FIG. 1;  
FIG. 3 is a top view of the attachment for a nail care instrument of FIG. 1;  
FIG. 4 is a side view of the attachment for a nail care instrument of FIG. 1;  
FIG. 5 is the other side view of the attachment for a nail care instrument of FIG. 1; and,  
FIG. 6 is a front view of the attachment for a nail care instrument of FIG. 1.

**1 Claim, 6 Drawing Sheets**

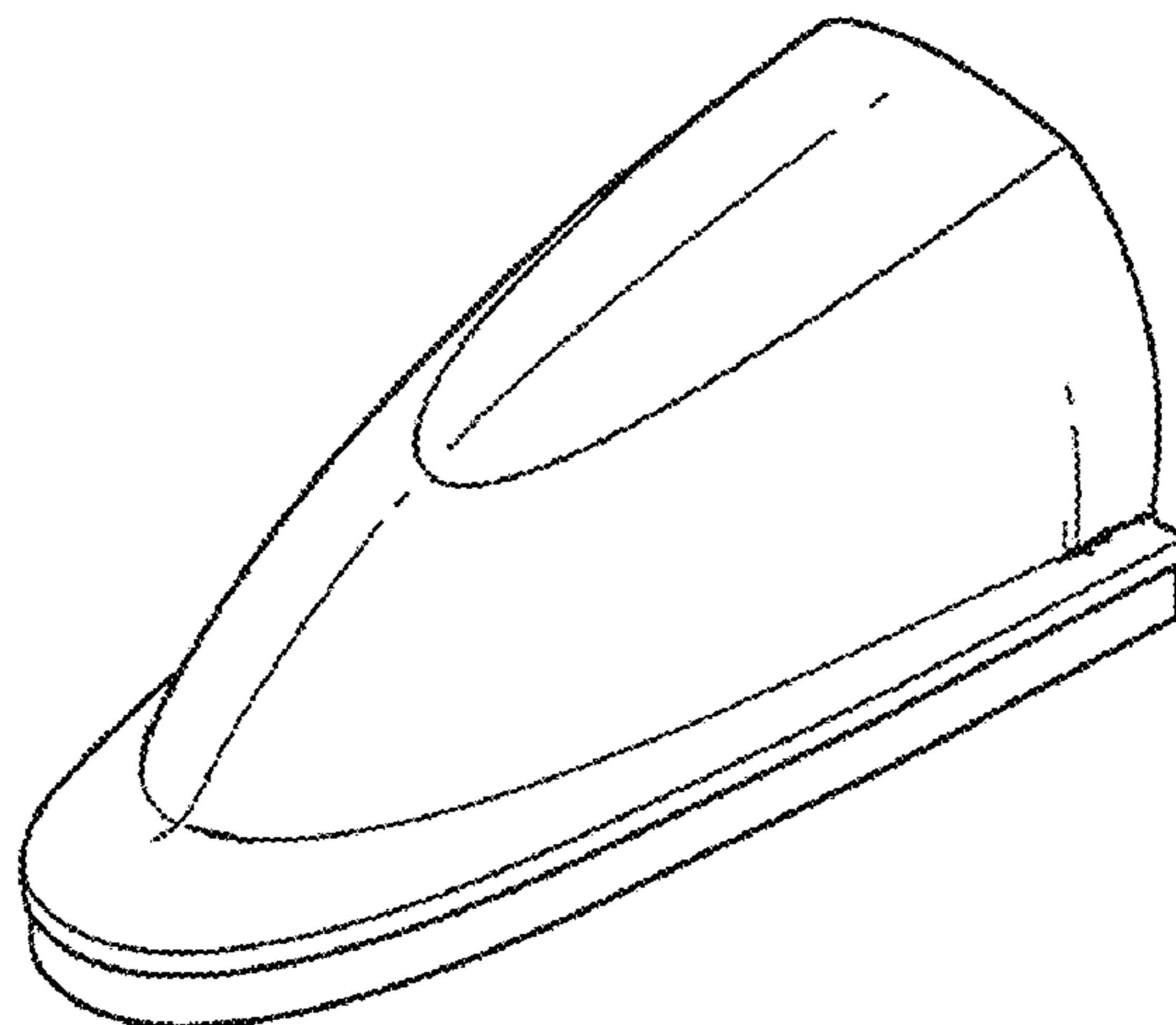

(56)

**References Cited**

U.S. PATENT DOCUMENTS

D450,887 S \* 11/2001 Christianson ..... D28/58  
6,367,482 B1 \* 4/2002 Baltheiser ..... A45D 29/00  
132/75  
D523,175 S \* 6/2006 Kriser ..... D28/60  
D545,497 S \* 6/2007 Feng ..... D28/59  
D546,502 S \* 7/2007 Lund ..... D28/60  
D572,864 S \* 7/2008 Rieser ..... D28/59  
D574,111 S \* 7/2008 Park ..... D28/55  
D575,001 S \* 8/2008 Park ..... D28/55  
D575,002 S \* 8/2008 Park ..... D28/55  
D582,606 S \* 12/2008 Lee ..... D28/59  
D670,506 S \* 11/2012 Kayser ..... D4/113  
D700,744 S \* 3/2014 An ..... D28/57  
2007/0028936 A1 \* 2/2007 Kriser ..... A45D 29/05  
132/76.4  
2016/0106194 A1 \* 4/2016 An ..... A45D 29/18  
132/76.4

\* cited by examiner

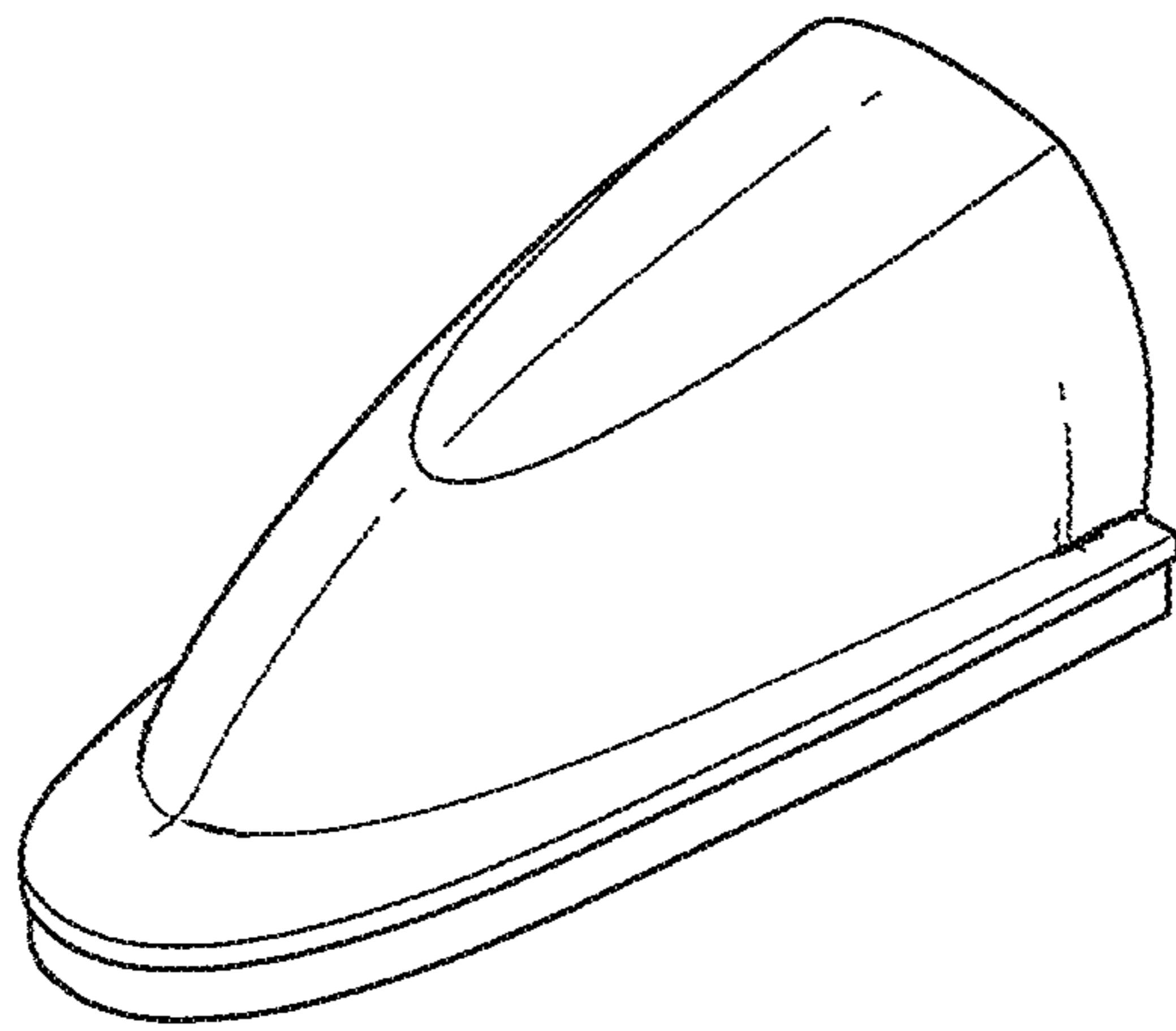

*Fig. 1*

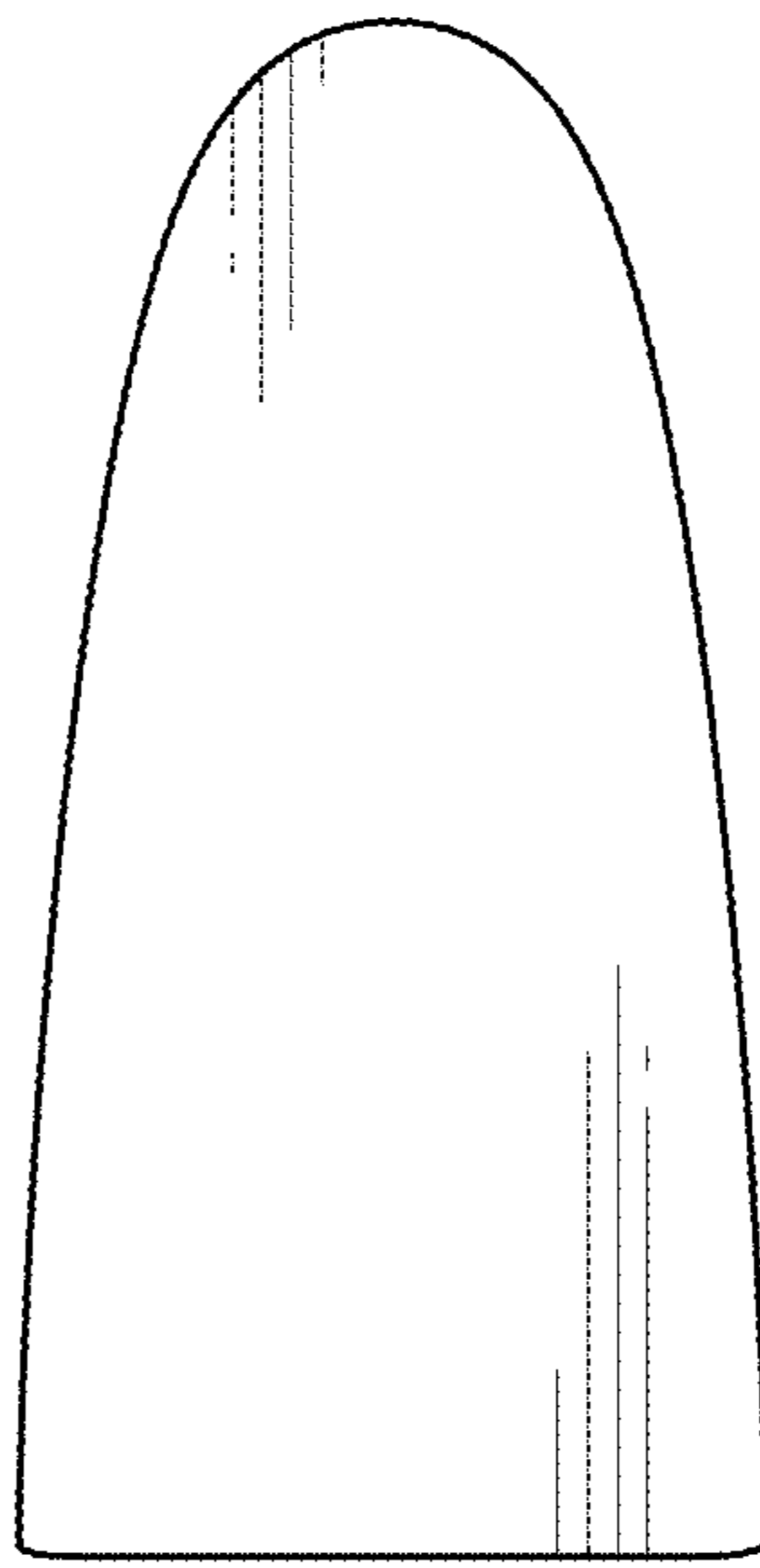

*Fig. 2*

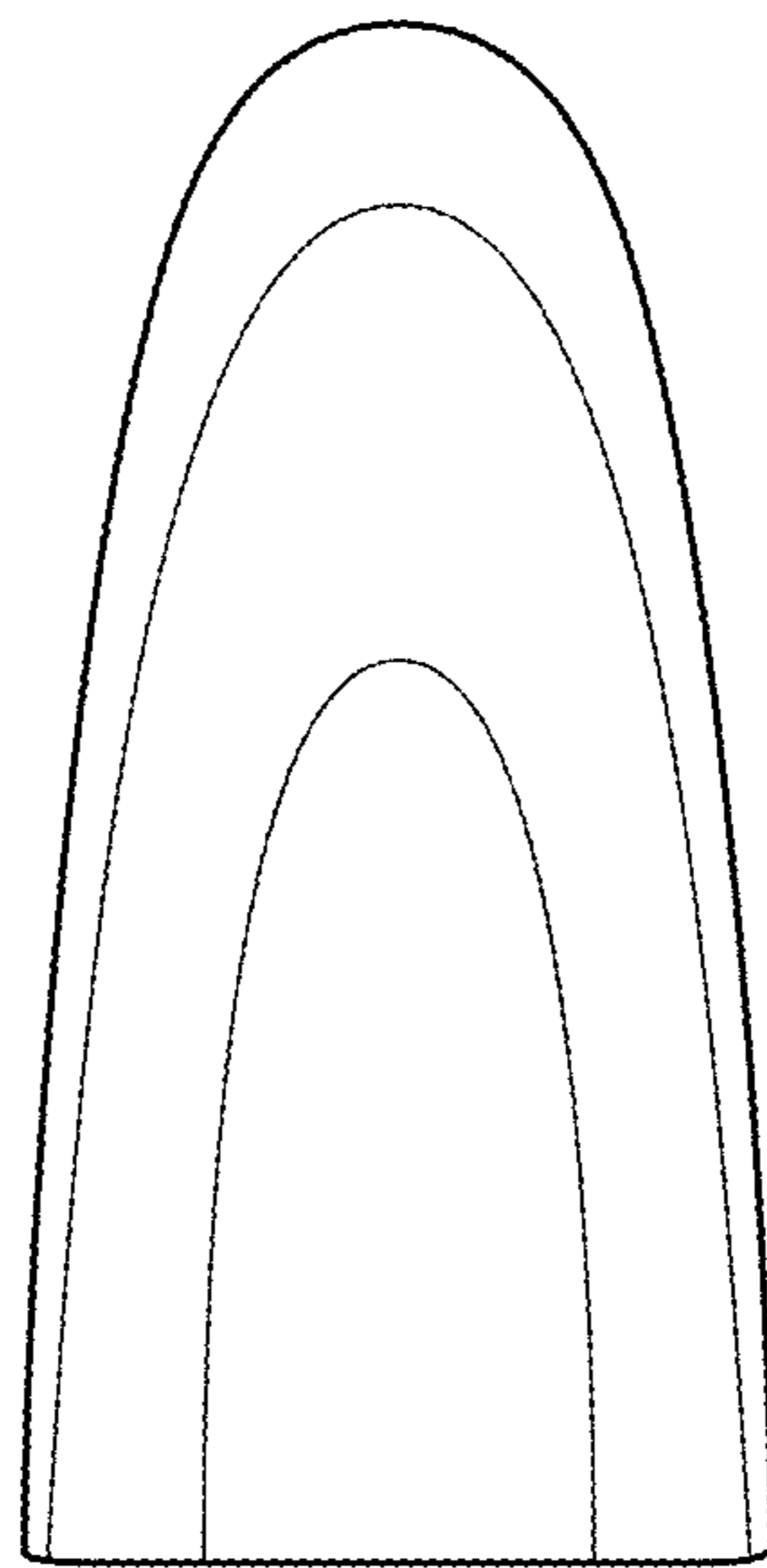

*Fig. 3*

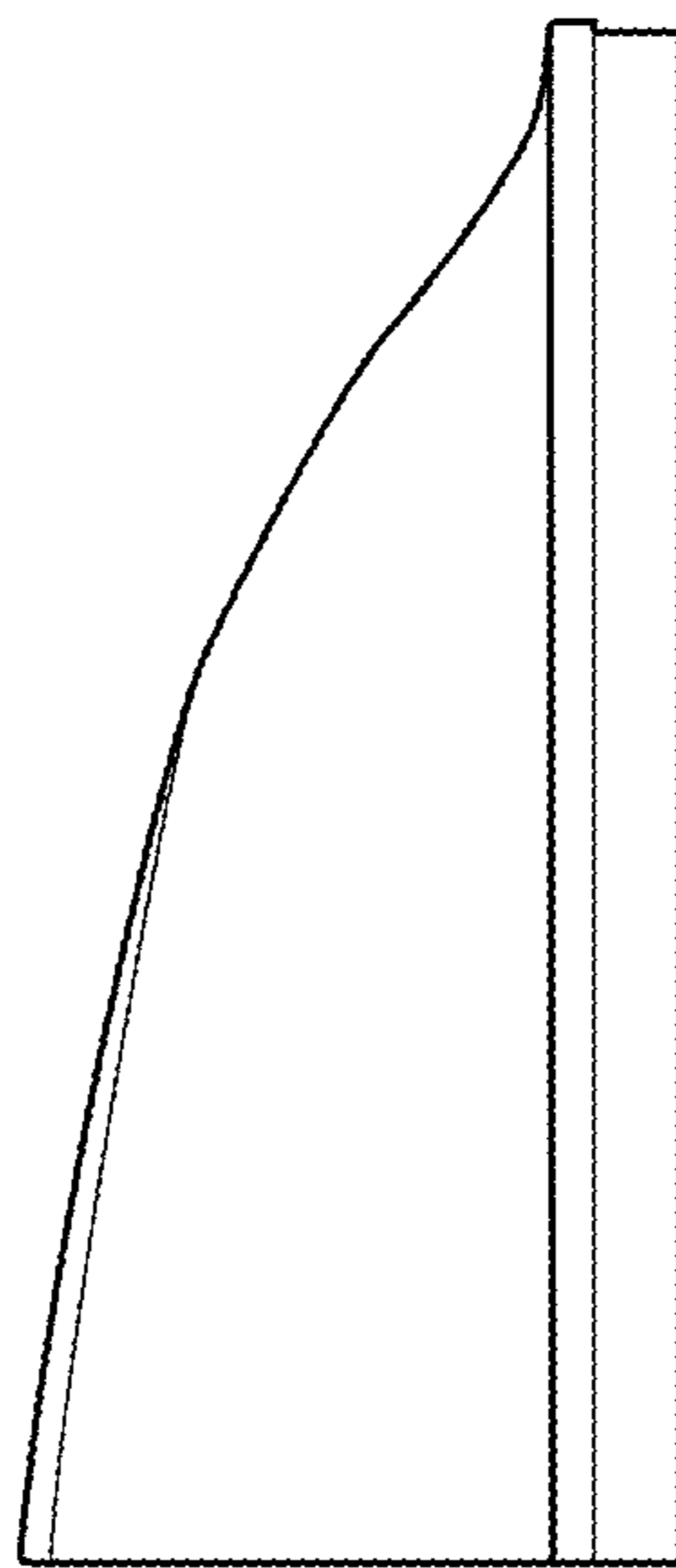

*Fig. 4*

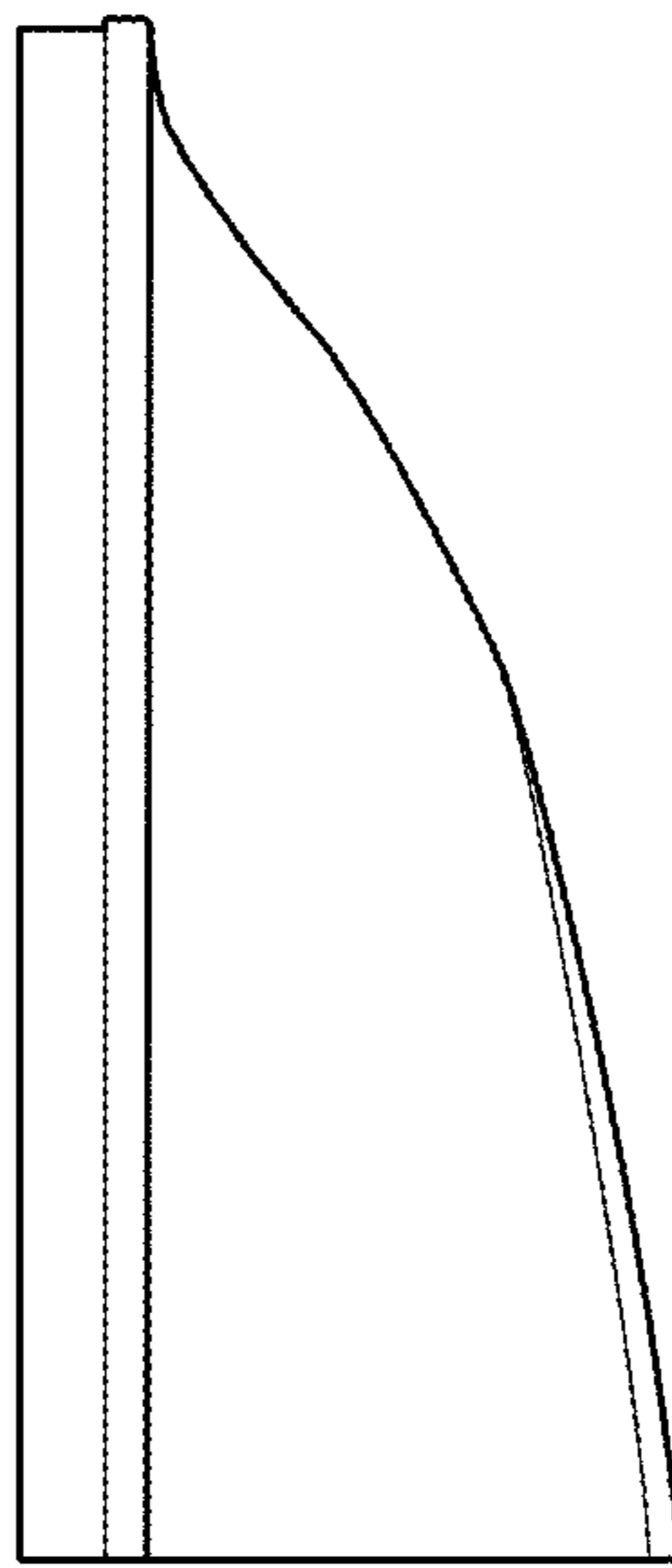

*Fig. 5*

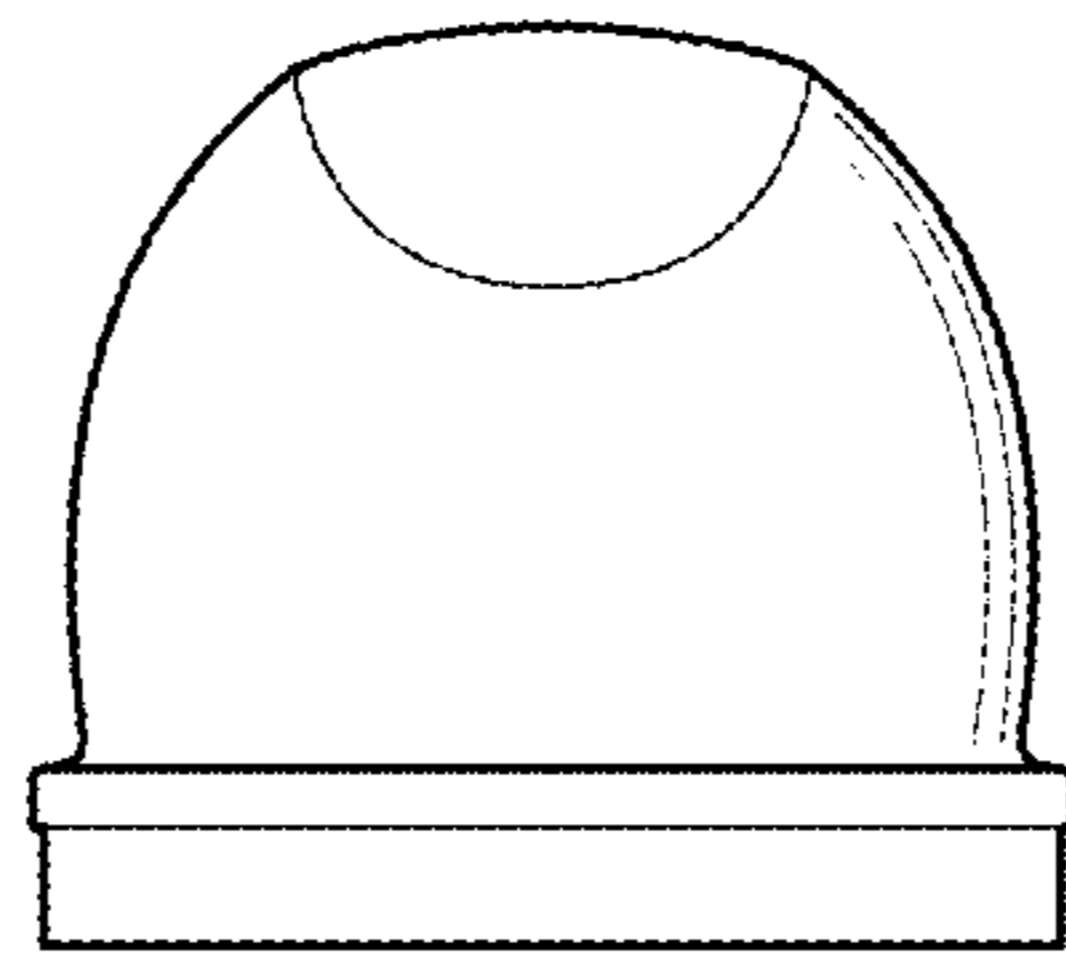

*Fig. 6*