



US00D771871S

(12) **United States Design Patent** (10) **Patent No.:** **US D771,871 S**  
**Butler et al.** (45) **Date of Patent:** **\*\* Nov. 15, 2016**

(54) **ATTACHMENT FOR A NAIL CARE INSTRUMENT**  
(71) Applicant: **Reckitt Benckiser (Brands) Limited**, Slough (GB)  
(72) Inventors: **Martin Butler**, Kwun Tong (HK); **Fiona Jones**, Slough (GB); **Darren Morgan**, Slough (GB); **Maartje Pel**, Warwick (GB); **Victoria Perrin**, Hull (GB); **Jackie Tsang**, Tin Shui Wai (HK); **Simon Woolley**, York (GB)  
(73) Assignee: **RECKITT BENCKISER (BRANDS) LIMITED**, Berkshire (GB)  
(\*\*) Term: **15 Years**

(21) Appl. No.: **29/534,906**  
(22) Filed: **Jul. 31, 2015**

(30) **Foreign Application Priority Data**  
Mar. 5, 2015 (EM) ..... 002646588-0004  
Jul. 13, 2015 (EM) ..... 002735712-0001

(51) **LOC (10) Cl.** ..... **28-03**  
(52) **U.S. Cl.**  
USPC ..... **D28/62**  
(58) **Field of Classification Search**  
USPC ..... D28/56, 57, 59, 60, 62; D4/113; 132/200, 73, 73.5, 73.6, 76.4, 75; 424/61  
CPC ..... A45D 31/00; A45D 29/18; A45D 29/05; A45D 29/04; A45D 29/20; A61Q 3/02  
See application file for complete search history.

(56) **References Cited**  
U.S. PATENT DOCUMENTS  
D168,018 S \* 10/1952 Cohn et al. .... D16/130  
D293,510 S \* 1/1988 Rudnick ..... D4/199  
D308,584 S \* 6/1990 Sells ..... D28/57

4,940,136 A \* 7/1990 Miller ..... A45D 29/02 132/75  
D318,248 S \* 7/1991 Samaras ..... D11/26  
D329,923 S \* 9/1992 Thaxton ..... D28/56  
D339,656 S \* 9/1993 Paladino ..... D28/56  
D347,296 S \* 5/1994 Adelman ..... D28/60  
D364,246 S \* 11/1995 Conerly ..... D28/60  
5,488,772 A \* 2/1996 Dababneh ..... A45D 29/023 132/75.5  
D391,679 S \* 3/1998 Harrison ..... D28/62  
D394,158 S \* 5/1998 Kramer ..... D4/113  
D394,731 S \* 5/1998 Lee ..... D28/60  
5,924,567 A \* 7/1999 Wenum ..... A46B 17/04 206/15.3  
D450,887 S \* 11/2001 Christianson ..... D28/58  
6,367,482 B1 \* 4/2002 Baltheiser ..... A45D 29/00 132/75  
D523,175 S \* 6/2006 Kriser ..... D28/60  
D545,497 S \* 6/2007 Feng ..... D28/59  
D546,502 S \* 7/2007 Lund ..... D28/60

(Continued)

*Primary Examiner* — John Windmuller  
*Assistant Examiner* — Steven Czyz  
(74) *Attorney, Agent, or Firm* — Troutman Sanders LLP;  
Ryan A. Schnedier; Chris N. Davis

(57) **CLAIM**  
The ornamental design for an attachment for a nail care instrument, as shown and described.

**DESCRIPTION**

FIG. 1 is a perspective view of an attachment for a nail care instrument of the present invention;  
FIG. 2 is a bottom view of the attachment for a nail care instrument of FIG. 1;  
FIG. 3 is a top view of the attachment for a nail care instrument of FIG. 1;  
FIG. 4 is a side view of the attachment for a nail care instrument of FIG. 1;  
FIG. 5 is the other side view of the attachment for a nail care instrument of FIG. 1; and,  
FIG. 6 is a front view of the attachment for a nail care instrument of FIG. 1.

**1 Claim, 6 Drawing Sheets**

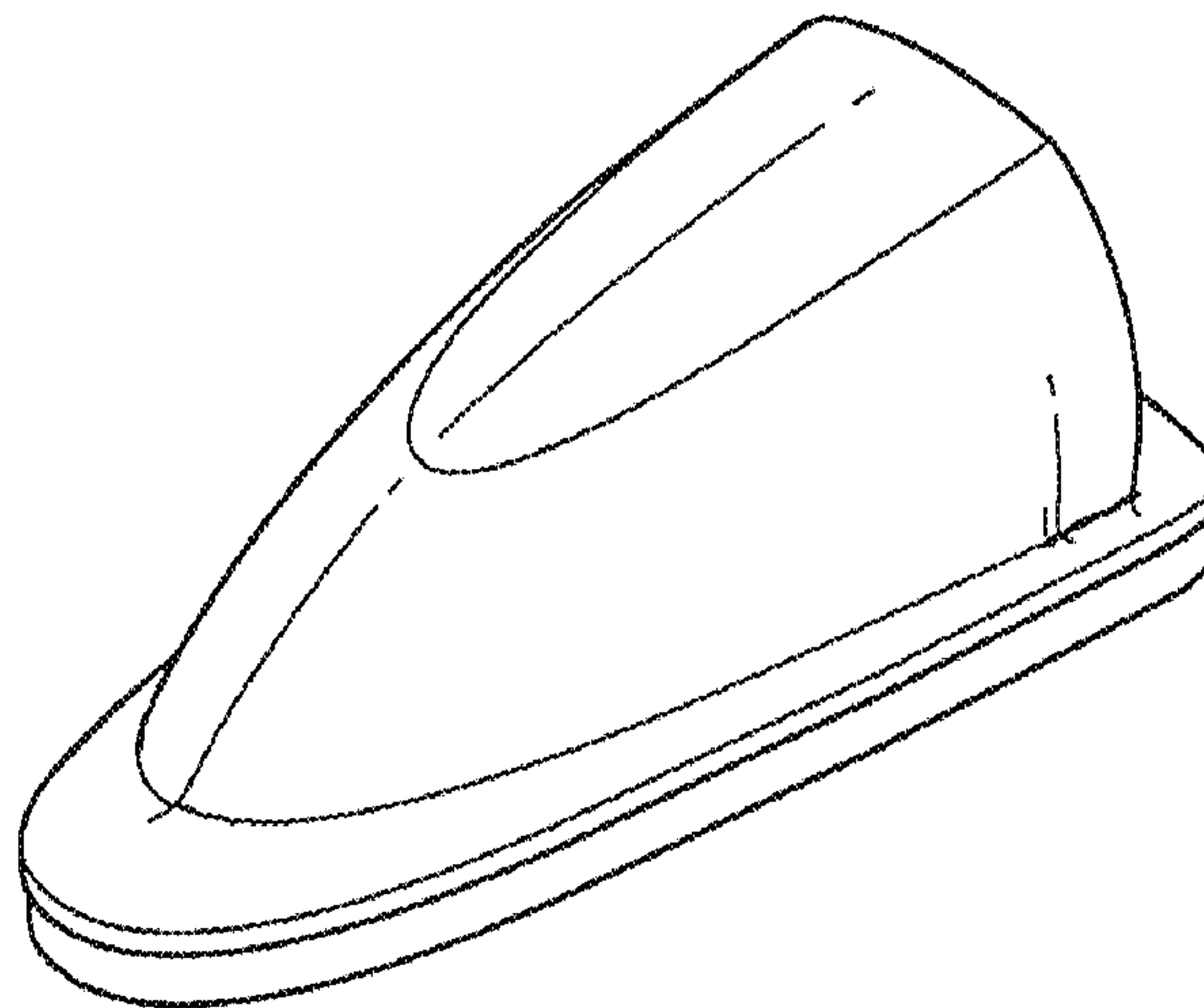

(56)

**References Cited**

U.S. PATENT DOCUMENTS

D572,864 S *	7/2008	Rieser .....	D28/59	D582,606 S *	12/2008	Lee .....	D28/59
D574,111 S *	7/2008	Park .....	D28/55	D670,506 S *	11/2012	Kayser .....	D4/113
D575,001 S *	8/2008	Park .....	D28/55	D700,744 S *	3/2014	An .....	D28/57
D575,002 S *	8/2008	Park .....	D28/55	2007/0028936 A1 *	2/2007	Kriser .....	A45D 29/05 132/76.4
				2016/0106194 A1 *	4/2016	An .....	A45D 29/18 132/76.4

\* cited by examiner

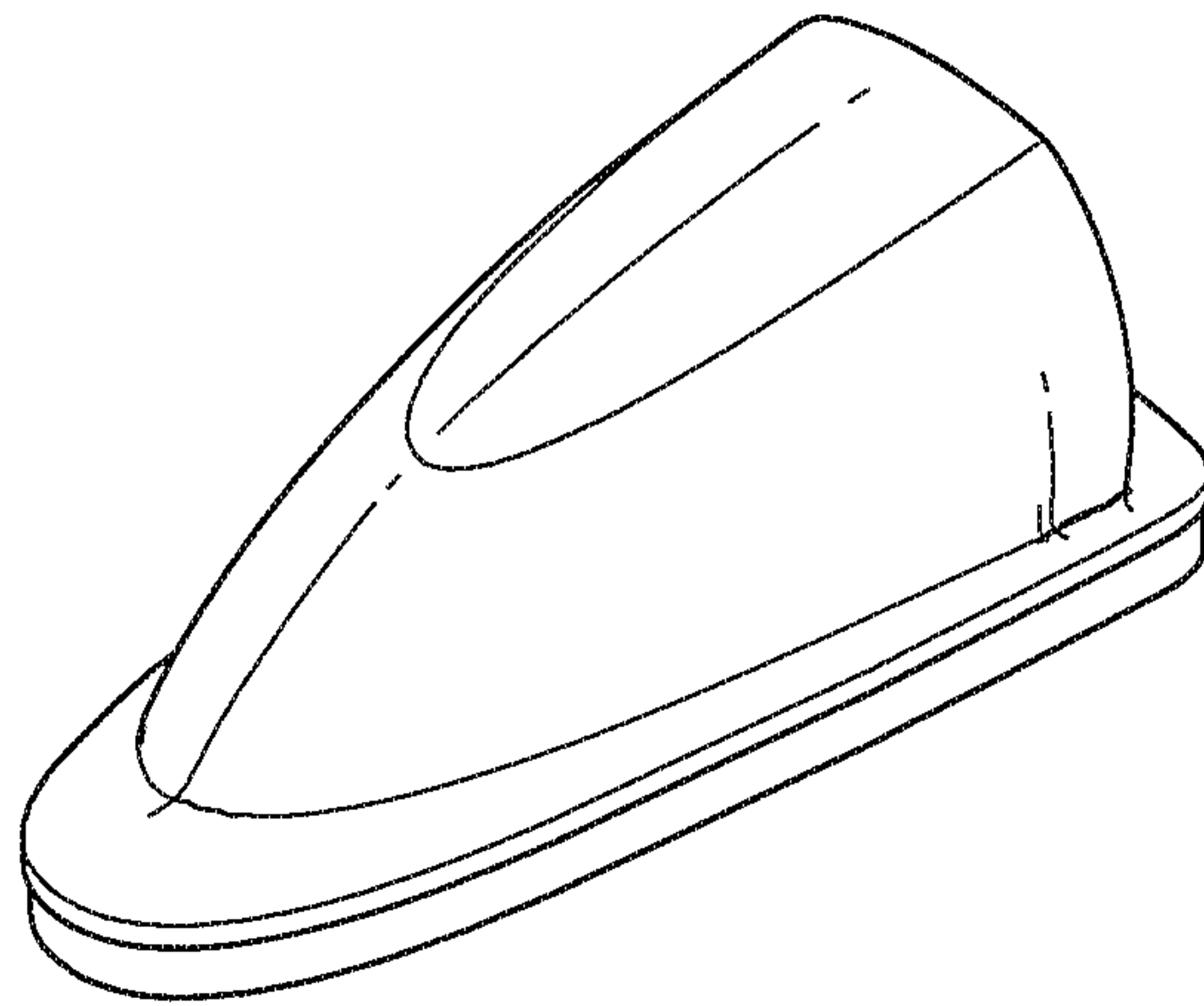

*Fig. 1*

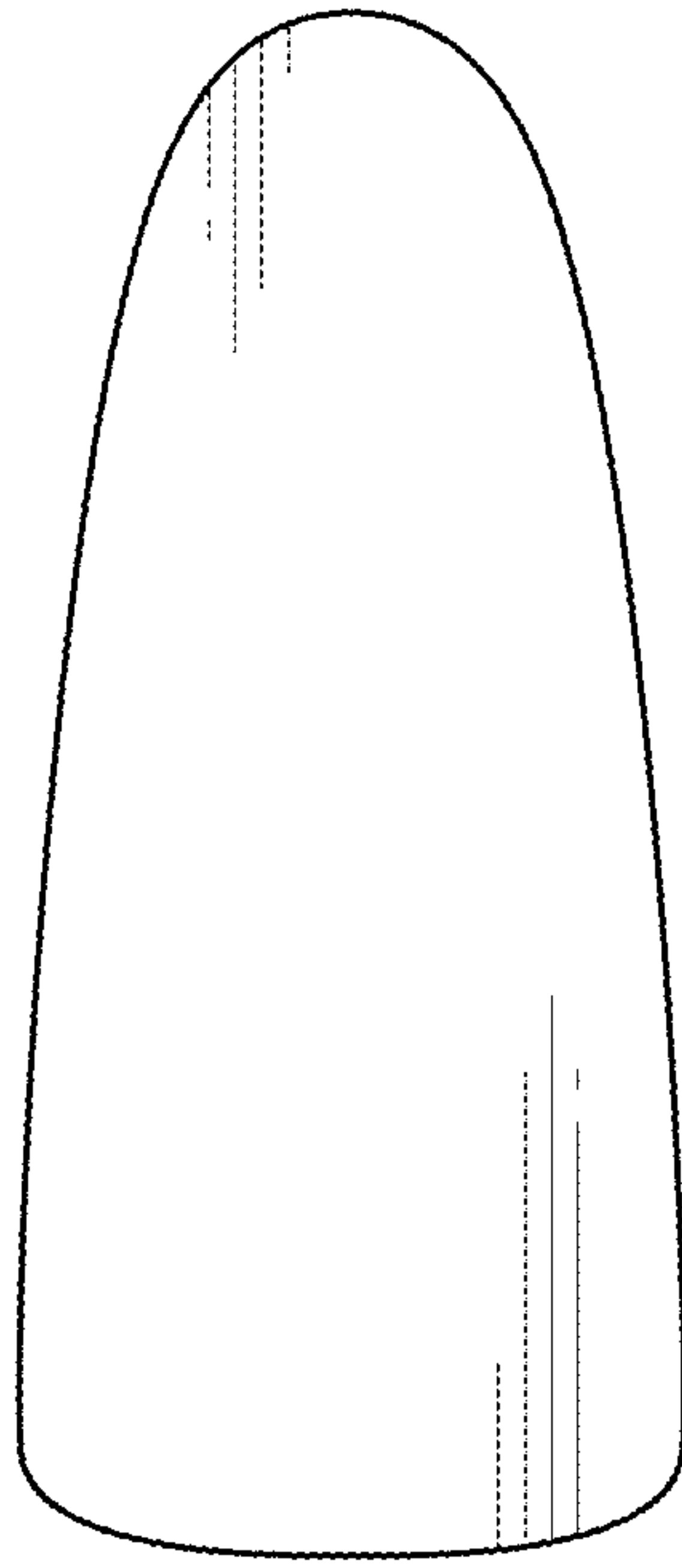

*Fig. 2*

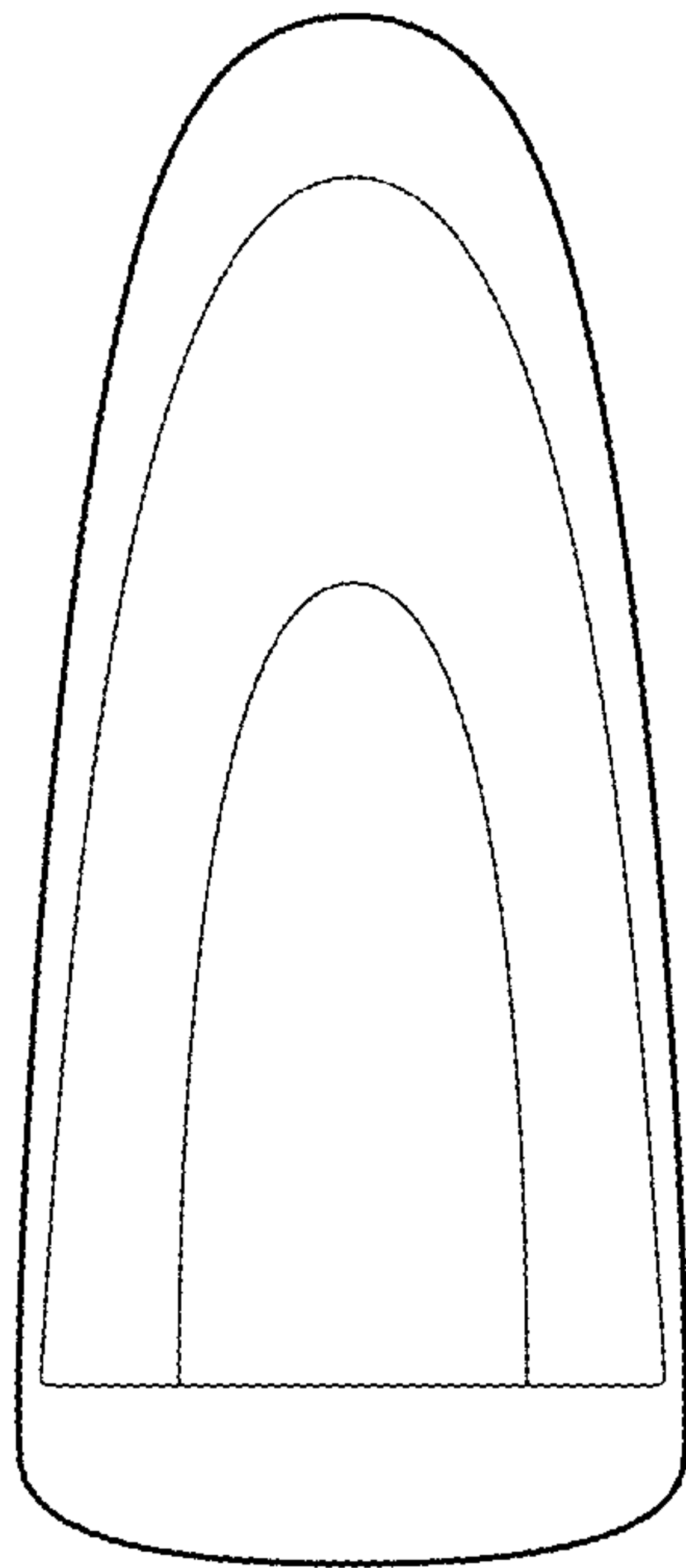

*Fig. 3*

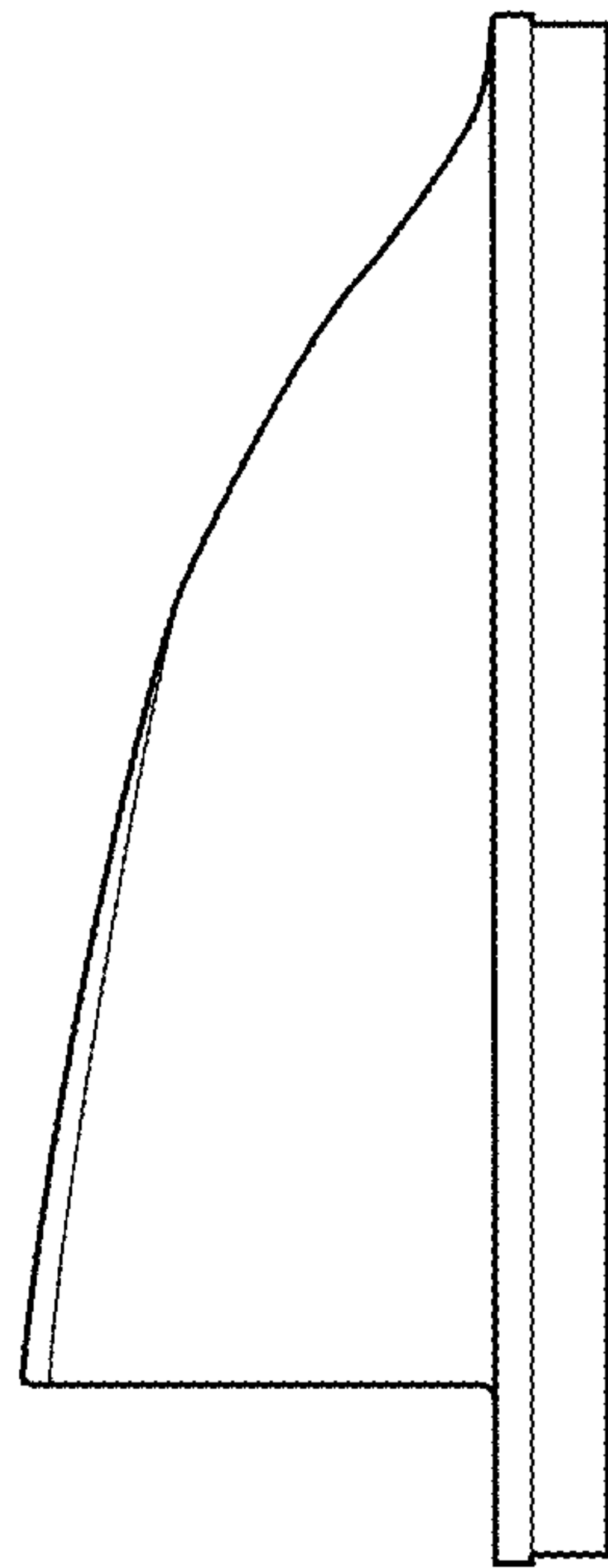

*Fig. 4*

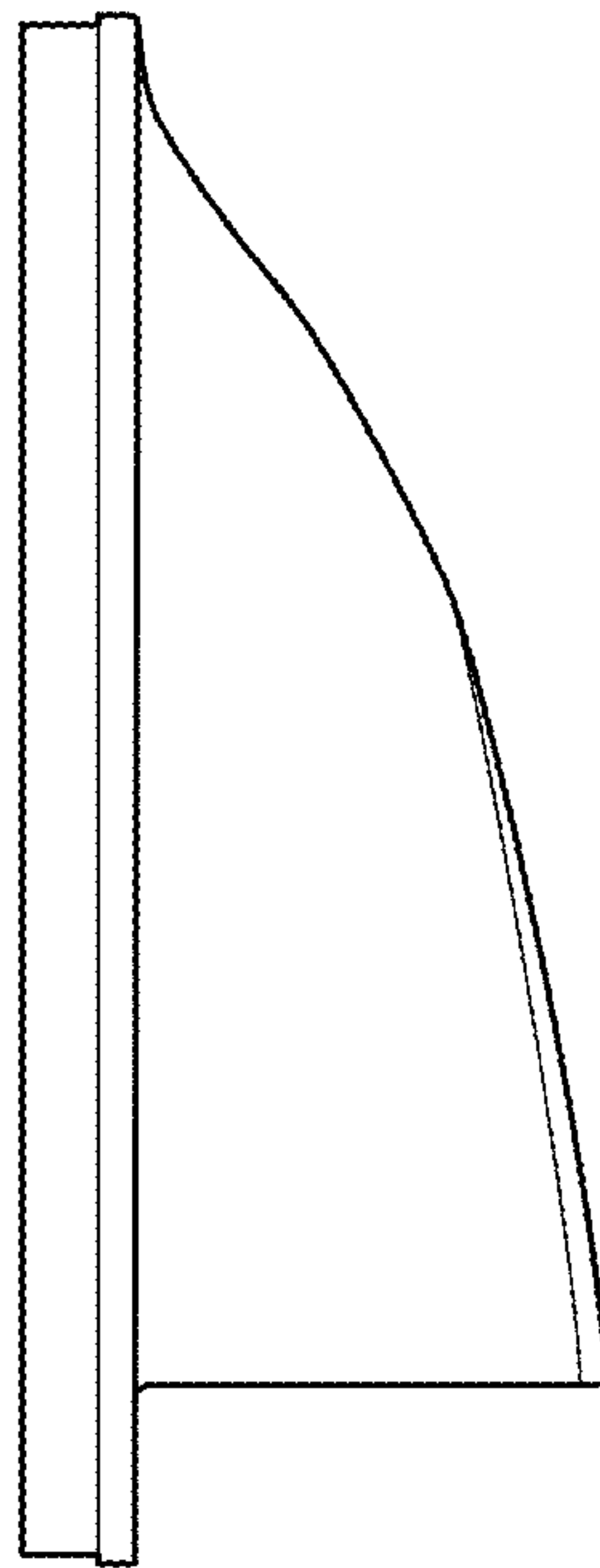

*Fig. 5*

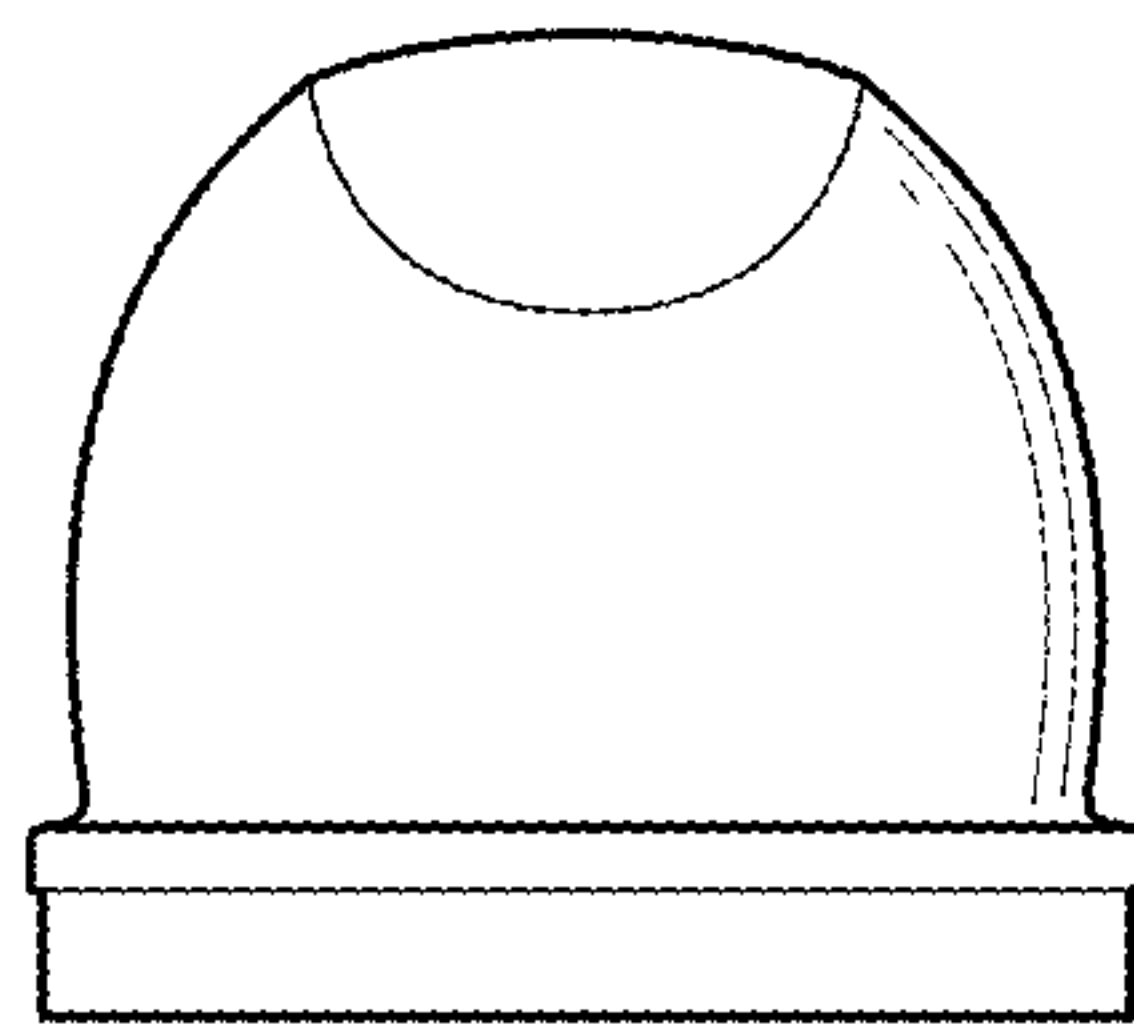

*Fig. 6*