



US00D771836S

(12) **United States Design Patent** (10) **Patent No.:** **US D771,836 S**
Siegel et al. (45) **Date of Patent:** **** Nov. 15, 2016**

(54) **COMBINED DOORS WITH ROOM**

D239,382 S * 3/1976 Moscatelli D25/7
D254,032 S * 1/1980 Broudy D25/33

(71) Applicant: **Apple Inc.**, Cupertino, CA (US)

(Continued)

(72) Inventors: **Jonathan P. Siegel**, San Francisco, CA (US); **Christopher M. Green**, Woodside, CA (US); **James Andrus**, San Francisco, CA (US); **David del Villar Fernandez**, San Francisco, CA (US); **David Nelson**, London (GB); **Stefan Behling**, London (GB); **David Summerfield**, London (GB); **James McGrath**, Cupertino, CA (US); **Ed Wright**, San Jose, CA (US); **Bo Yoon**, San Francisco, CA (US); **Ton Men Banh**, Santa Clara, CA (US)

OTHER PUBLICATIONS

<http://applestorefronts.appspot.com/>—Store Opened Jan. 28, 2006.*

(Continued)

Primary Examiner — Manpreet Matharu
Assistant Examiner — Mojtaba Tehrani
(74) *Attorney, Agent, or Firm* — Sterne, Kessler, Goldstein & Fox P.L.L.C.

(73) Assignee: **APPLE INC.**, Cupertino, CA (US)

(57) **CLAIM**
The ornamental design for combined doors with room, as shown and described.

(**) Term: **14 Years**

DESCRIPTION

(21) Appl. No.: **29/517,044**

FIG. 1 is a front perspective view of combined doors with room in a first state showing the claimed design;
FIG. 2 is a front view thereof;
FIG. 3 is a rear view thereof;
FIG. 4 is a left side view thereof;
FIG. 5 is a right side view thereof;
FIG. 6 is a top view thereof;
FIG. 7 is a bottom view thereof;
FIG. 8 is a front perspective view of the combined doors with room of FIG. 1 in a second state;
FIG. 9 is a front view thereof;
FIG. 10 is a rear view thereof;
FIG. 11 is a left side view thereof;
FIG. 12 is a right side view thereof;
FIG. 13 is a top view thereof; and,
FIG. 14 is a bottom view thereof.

(22) Filed: **Feb. 9, 2015**

(51) **LOC (10) Cl.** **25-03**

(52) **U.S. Cl.**
USPC **D25/33**

(58) **Field of Classification Search**
USPC D25/4, 12, 15, 23, 33, 48.3, 48.4, 48.5, D25/48.8
CPC E06B 3/485; E06B 2003/7044; E06B 3/4636; E06B 3/72; E06B 3/78; E06B 1/04; E06B 5/00

See application file for complete search history.

The broken lines in the figures show portions of the combined doors with room or environment that form no part of the claimed design.

The oblique shade lines in the Figures show transparency or translucency.

(56) **References Cited**

U.S. PATENT DOCUMENTS

2,043,472 A * 6/1936 Eager E05D 15/403 49/200
D149,775 S * 5/1948 Rubaloff D25/33
D212,742 S * 11/1968 Long D25/33
D222,854 S * 1/1972 Weiss D25/33

1 Claim, 10 Drawing Sheets

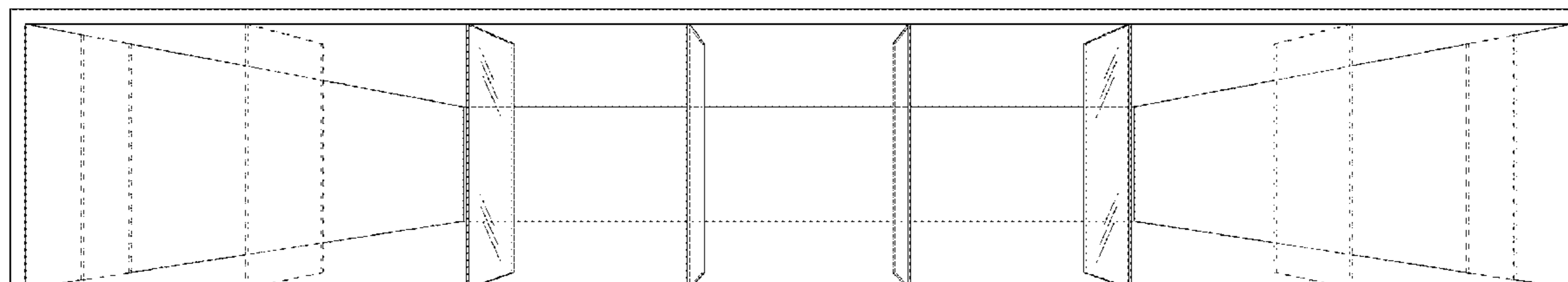
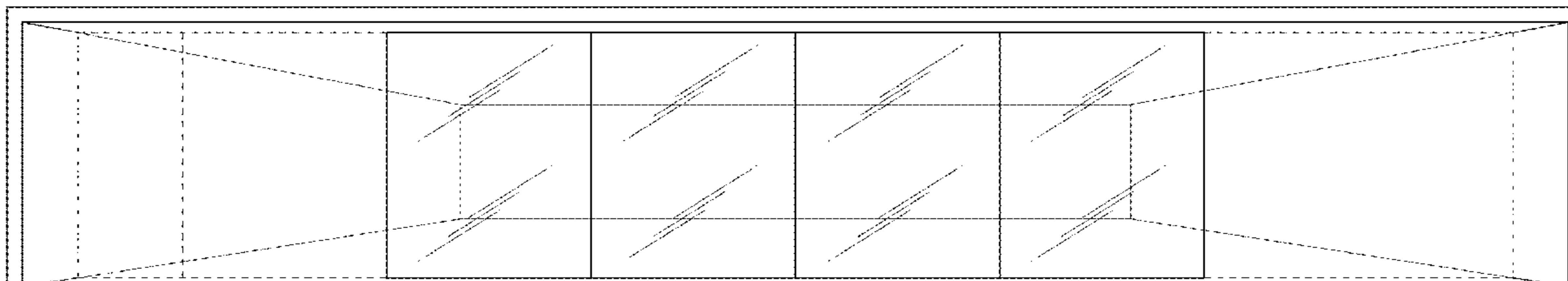

(56)

References Cited

U.S. PATENT DOCUMENTS

6,532,699 B1 * 3/2003 Franklin E06B 5/00
47/17
D559,403 S * 1/2008 Vils D25/3
D671,573 S * 11/2012 Behr D15/91
D712,067 S * 8/2014 Backus D25/32
D720,082 S * 12/2014 O'Callaghan D25/33
D726,334 S * 4/2015 O'Callaghan D25/33

OTHER PUBLICATIONS

<http://www.archdaily.com/378881/madison-house-xten-architecture>—Published May 30, 2013.*
<http://freshome.com/2012/01/17/dark-skinned-light-flooded-lake-house-in-nevada/>—Published Jan. 17, 2012.*
Photograph 1: Photograph believed taken before Feb. 6, 2015.
Photograph 2: Photograph believed taken before Feb. 6, 2015.
Photograph 3: Photograph believed taken before Feb. 6, 2015.

* cited by examiner

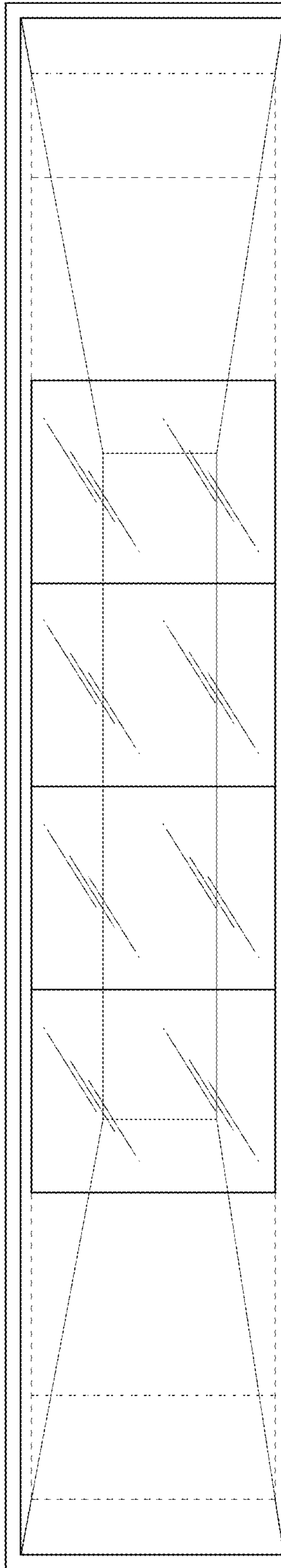

FIG. 1

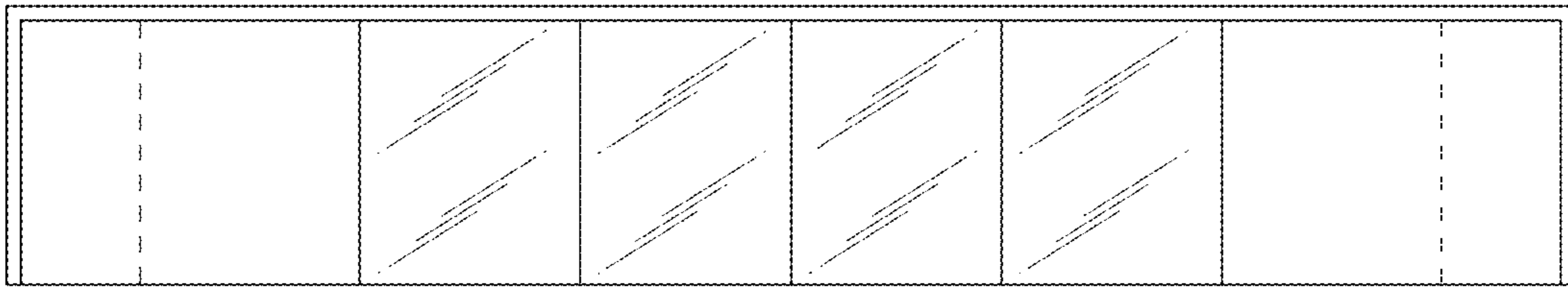

FIG. 2



FIG. 3

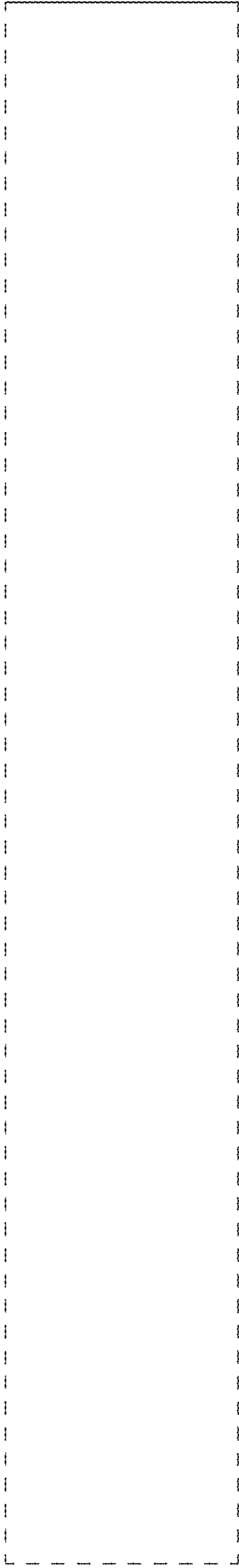

FIG. 4

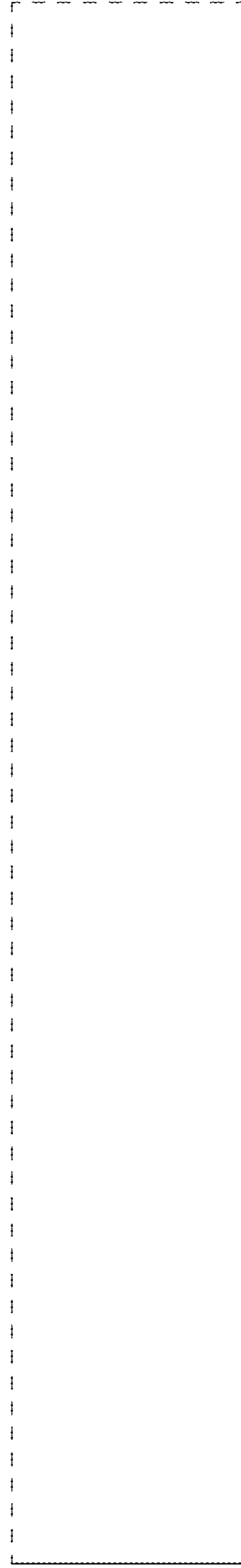

FIG. 5

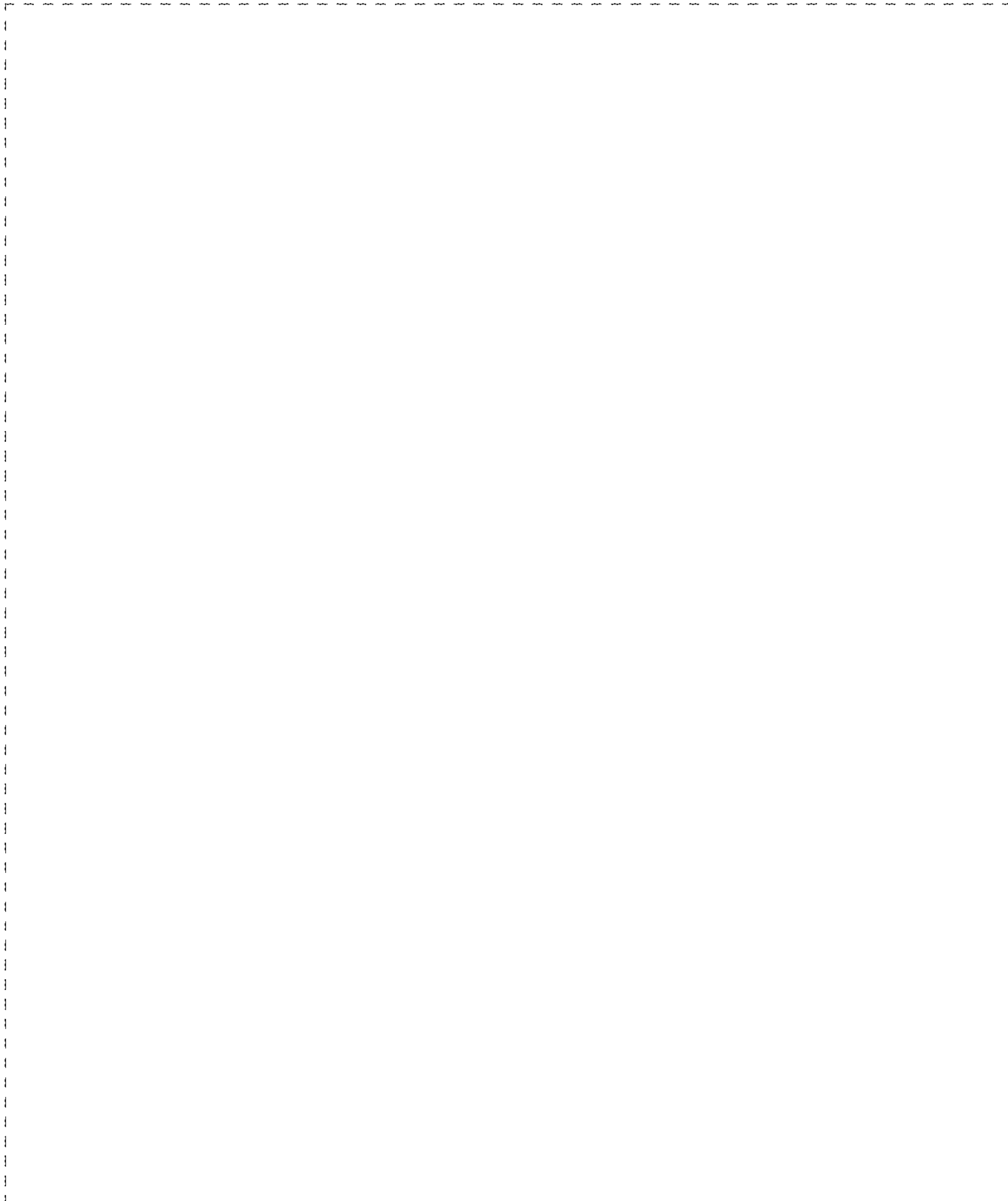

FIG. 6

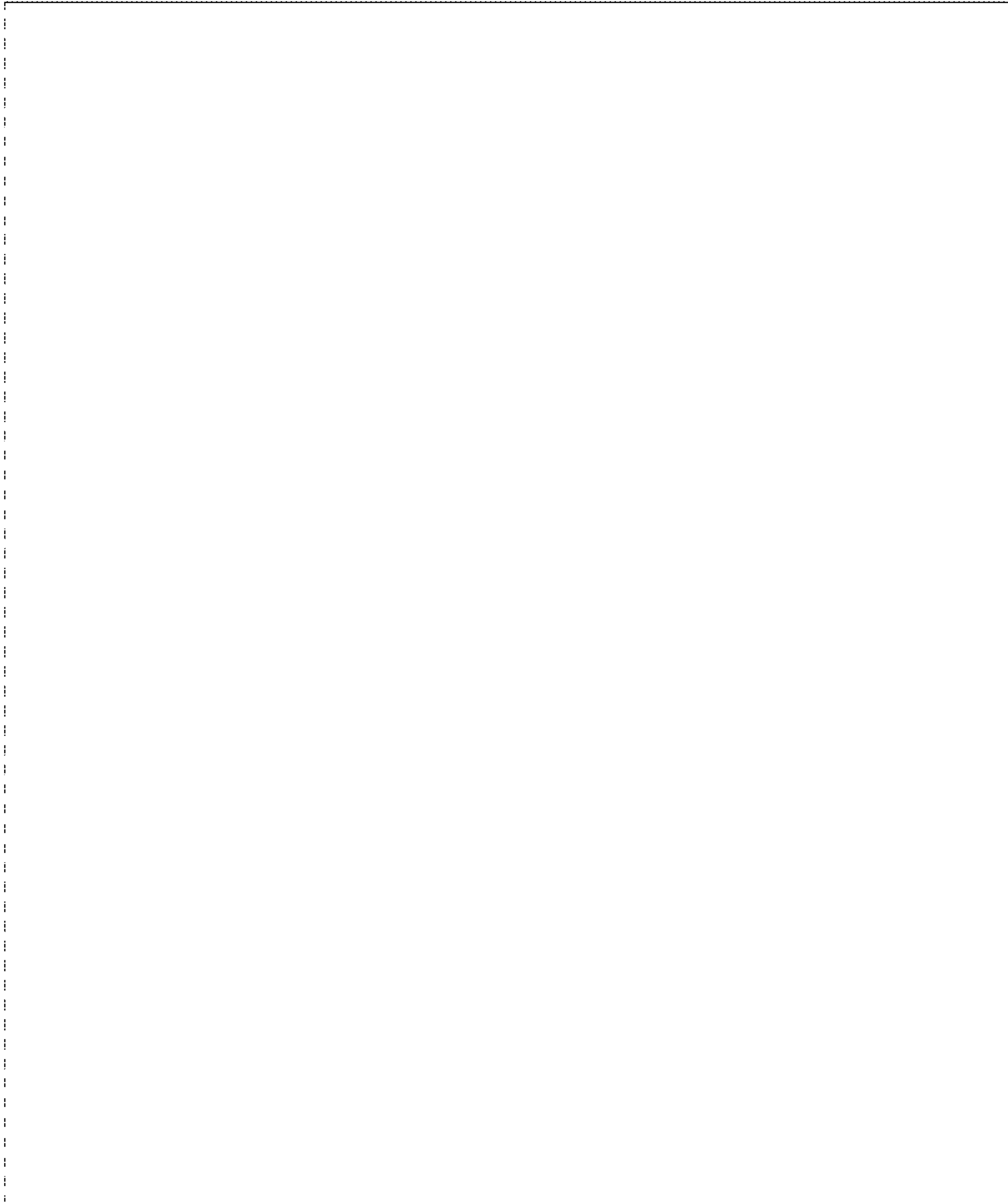

FIG. 7

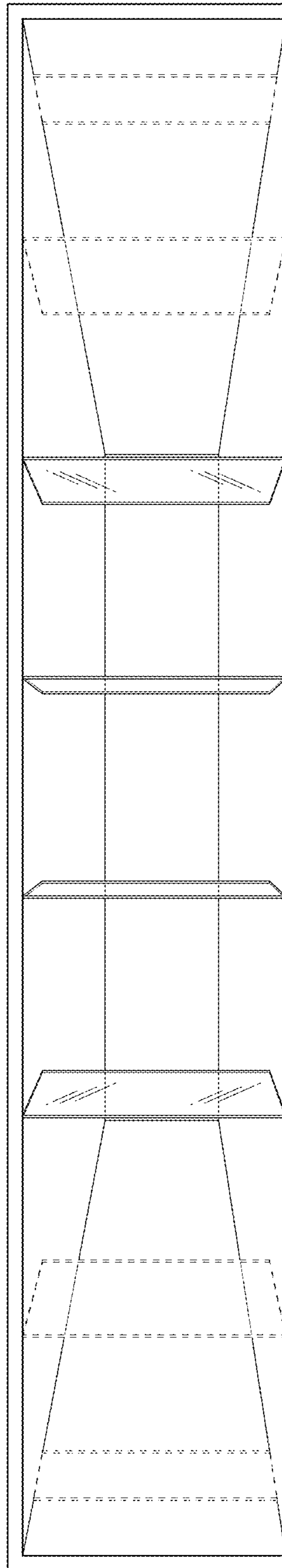

FIG. 8

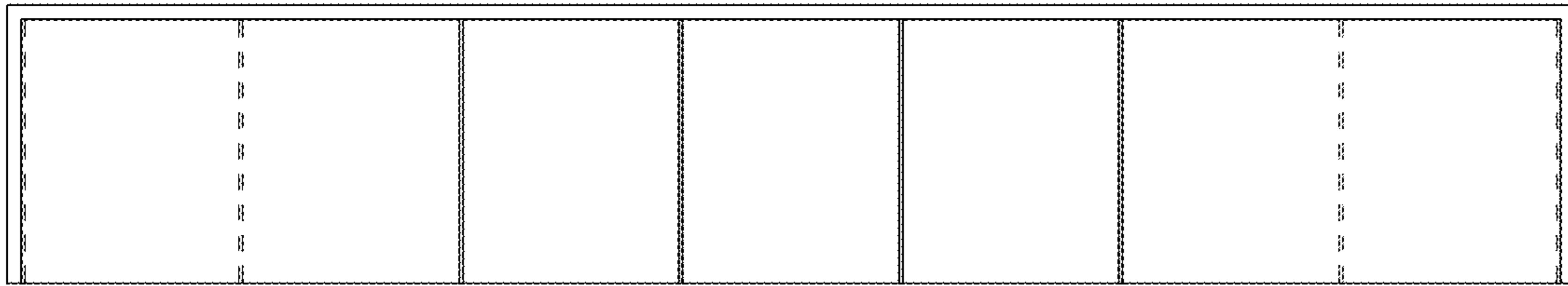

FIG. 9



FIG. 10

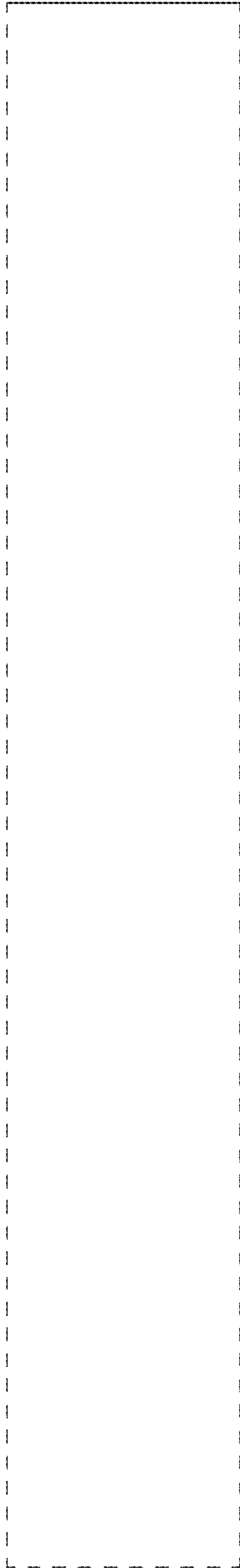

FIG. 11

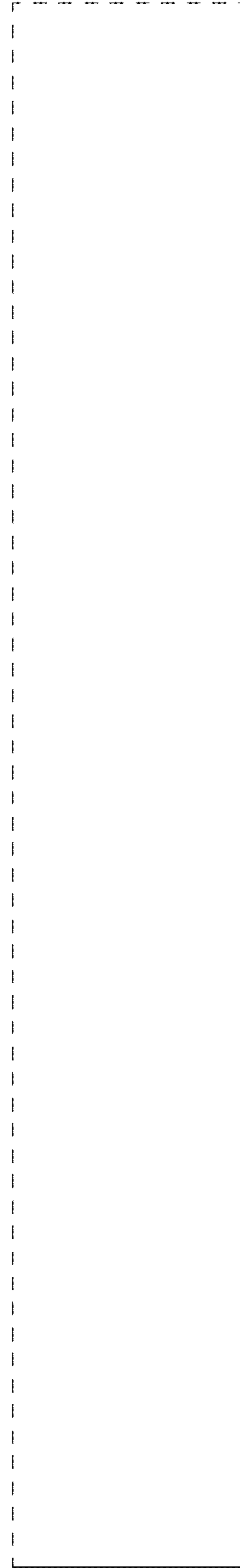

FIG. 12

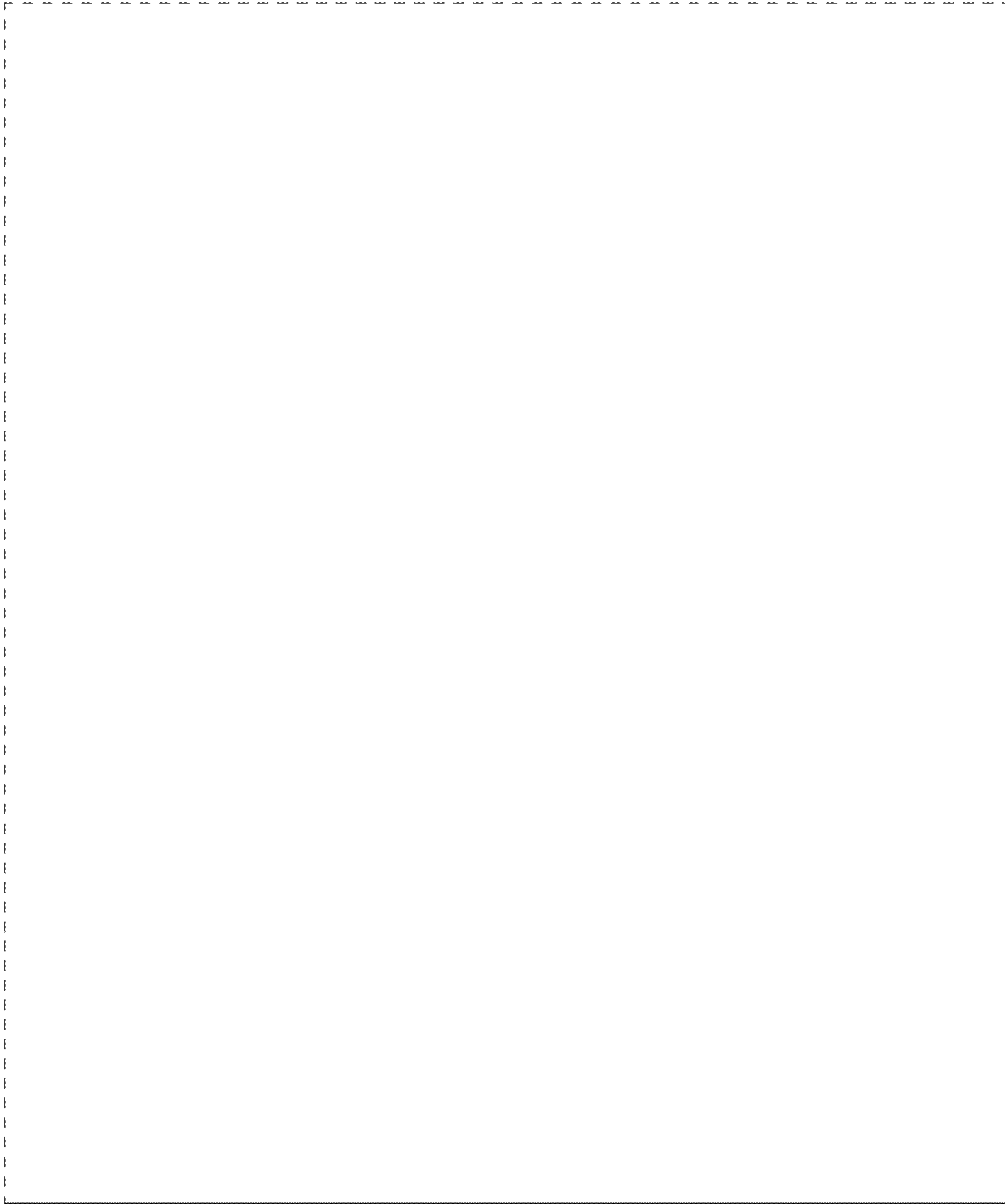

FIG. 13

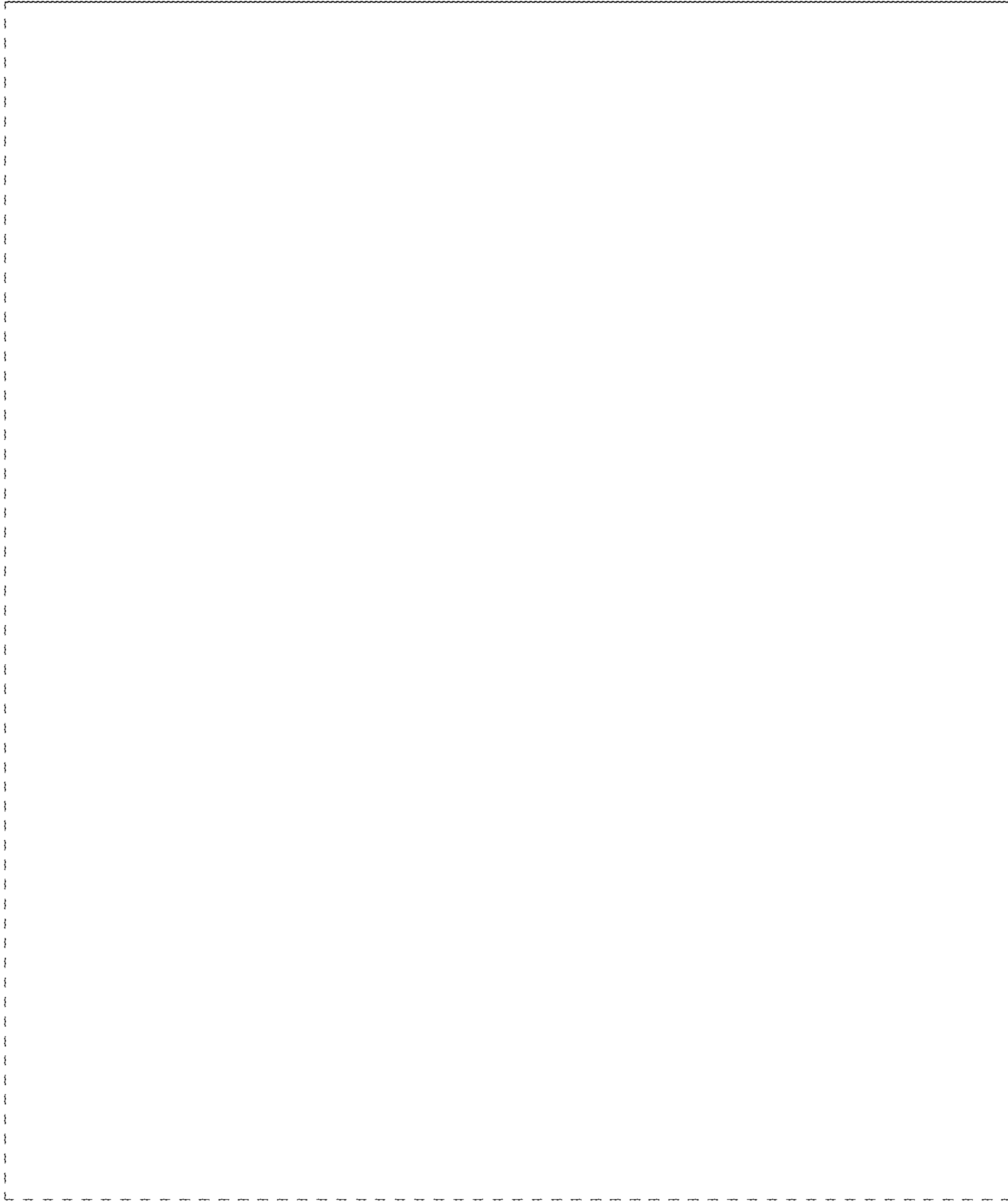

FIG. 14