



US00D771804S

(12) **United States Design Patent** (10) **Patent No.:** **US D771,804 S**
York (45) **Date of Patent:** **** Nov. 15, 2016**

(54) **COMMODE PAIL**

(71) Applicant: **Marcus York**, Anderson, IN (US)

(72) Inventor: **Marcus York**, Anderson, IN (US)

(**) Term: **15 Years**

(21) Appl. No.: **29/545,208**

(22) Filed: **Nov. 10, 2015**

(51) **LOC (10) Cl.** **24-04**

(52) **U.S. Cl.**
USPC **D24/123**

(58) **Field of Classification Search**
USPC D24/121-123, 117, 224; D23/276, 295,
D23/302, 274, 309, 200; 4/450-460,
4/144.1-144.4, DIG. 5; 600/573, 574;
604/329, 317, 318, 334
CPC A61G 9/00; A61G 9/006; A61G 9/003
See application file for complete search history.

(56) **References Cited**

U.S. PATENT DOCUMENTS

D605,754 S	*	12/2009	Nelson	D24/121
D607,557 S	*	1/2010	Wiggins	D24/108
D610,254 S	*	2/2010	Huff	D24/121
D645,559 S	*	9/2011	Green	D24/121
D662,217 S	*	6/2012	Brown	D24/224

D668,331 S	*	10/2012	Ren	D24/123
D669,979 S	*	10/2012	Adams	D24/123
D670,377 S	*	11/2012	Adams	D24/123
D674,482 S	*	1/2013	Wurapa	D24/121
D710,701 S	*	8/2014	Lai	D24/123
D711,195 S	*	8/2014	Cornu	D10/46.2
D738,491 S	*	9/2015	Foley	D24/121
D746,979 S	*	1/2016	Dominguez	D24/121

* cited by examiner

Primary Examiner — David Muller

(74) *Attorney, Agent, or Firm* — Thomas E. Lees, LLC

(57) **CLAIM**

The ornamental design for a commode pail, as shown and described.

DESCRIPTION

FIG. 1 is a perspective view of the commode pail;
FIG. 2 is a left side elevation view thereof;
FIG. 3 is a right side elevation view thereof;
FIG. 4 is a front elevation view thereof;
FIG. 5 is a rear elevation view thereof;
FIG. 6 is a top plan view thereof; and,
FIG. 7 is a bottom plan view thereof.

1 Claim, 5 Drawing Sheets

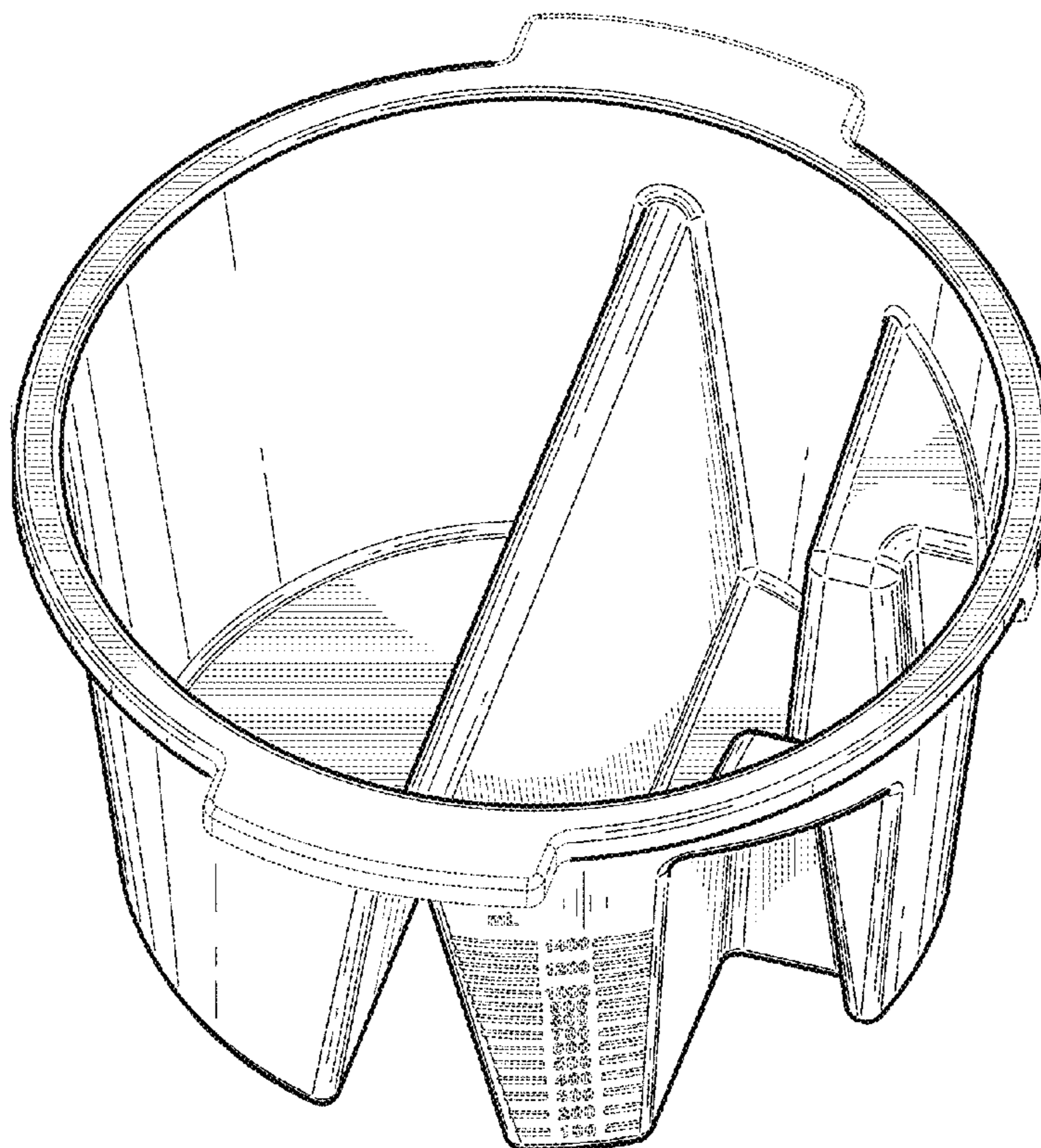

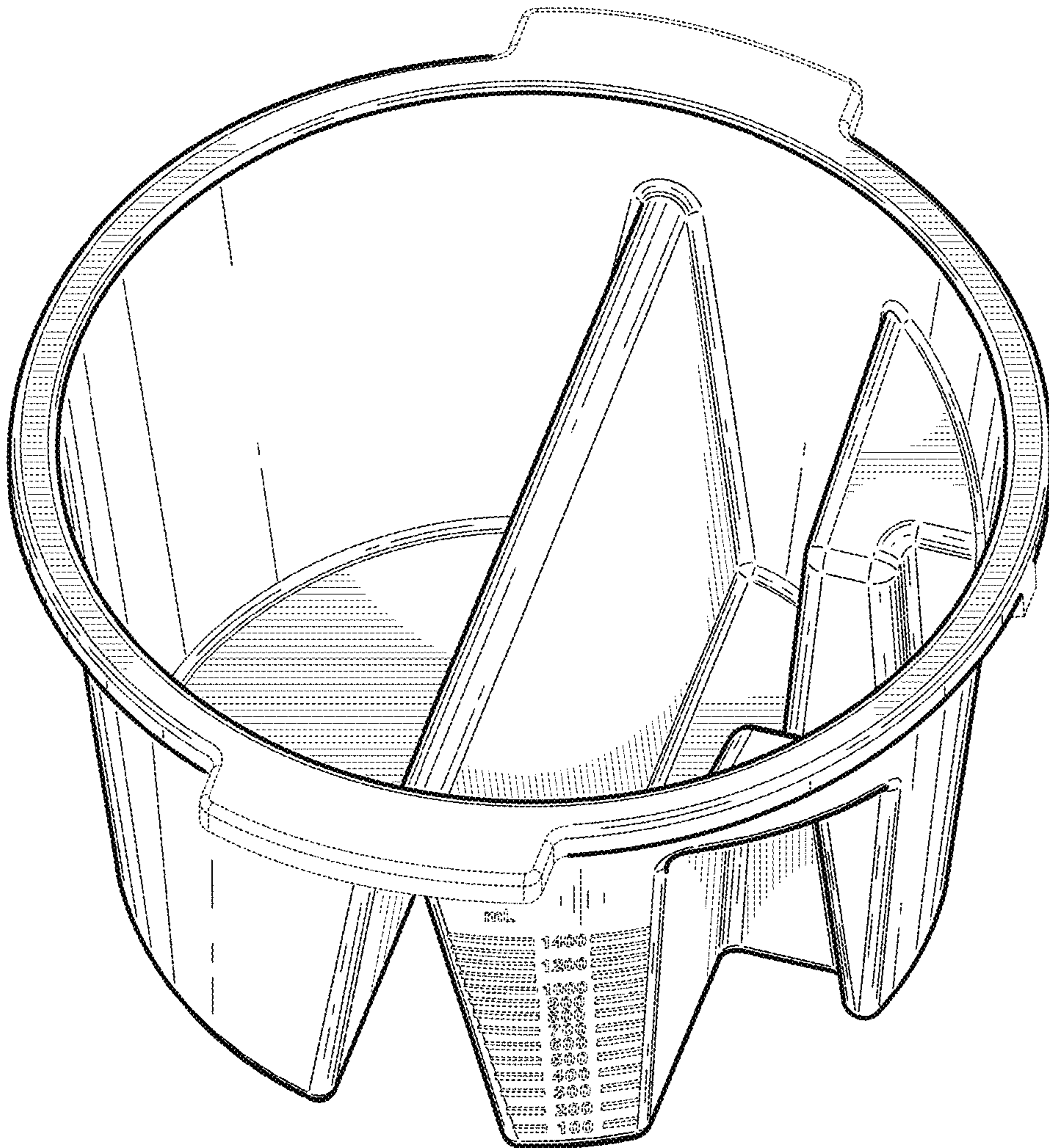

FIG. 1

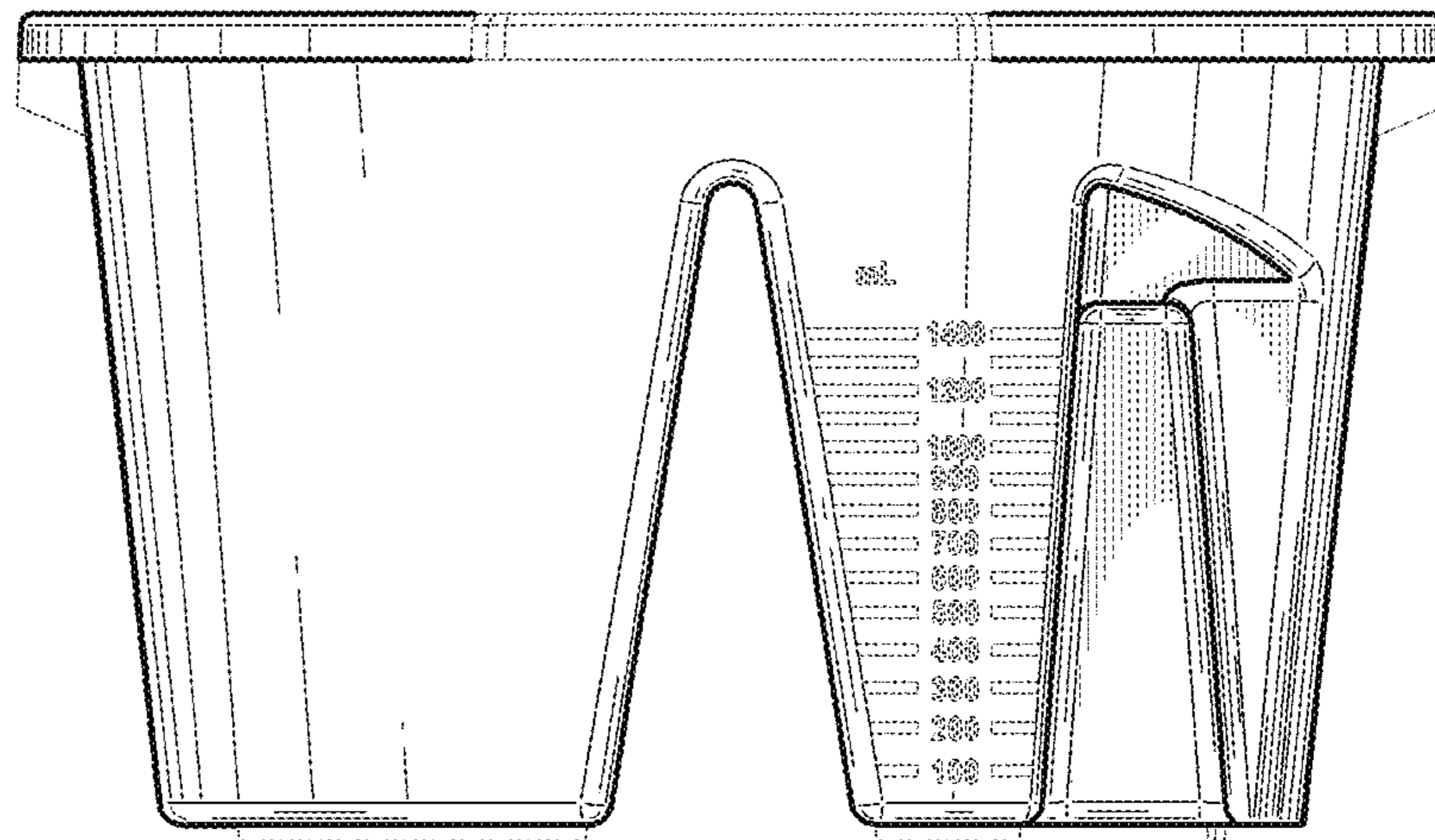

FIG. 2

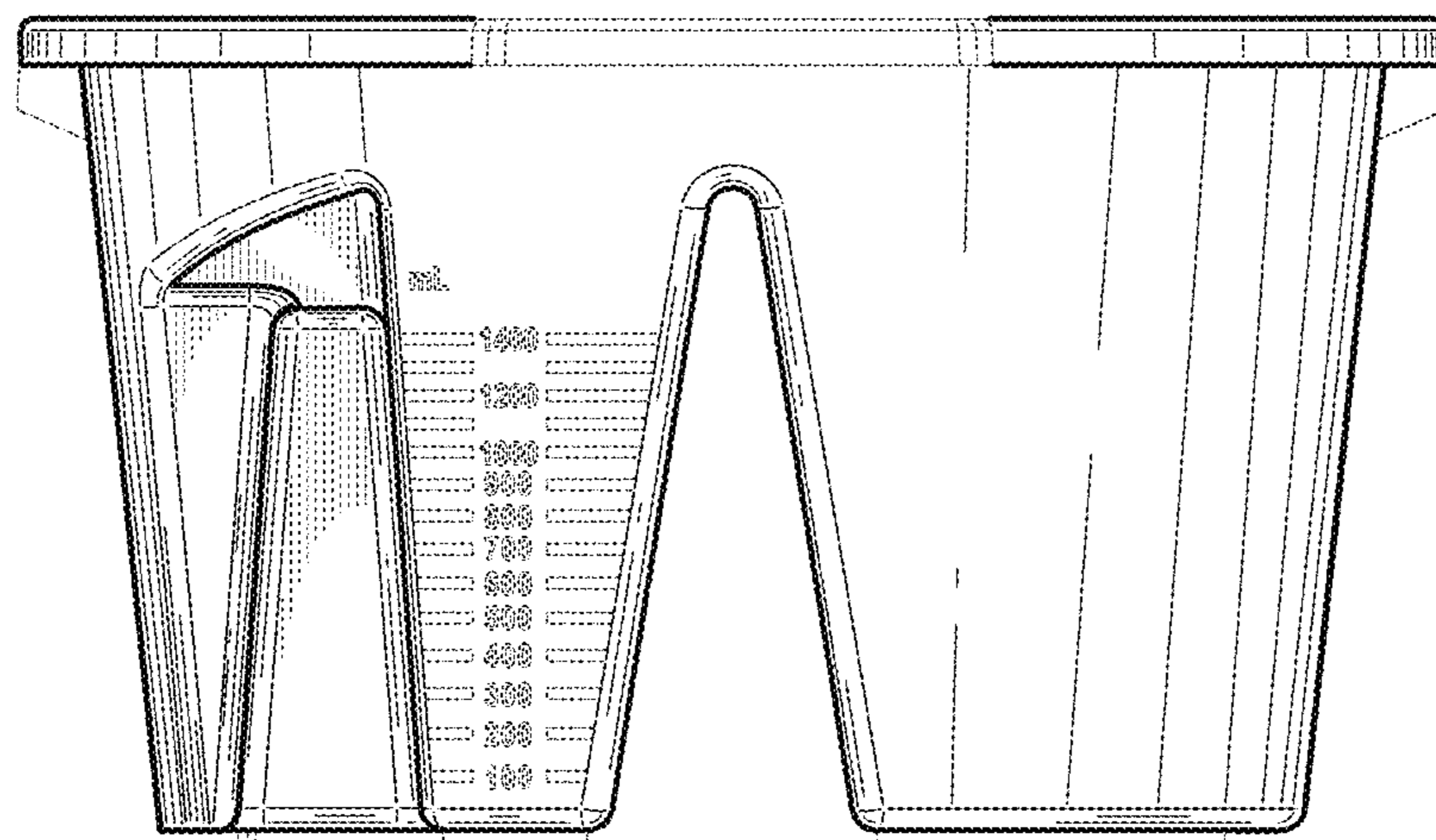

FIG. 3

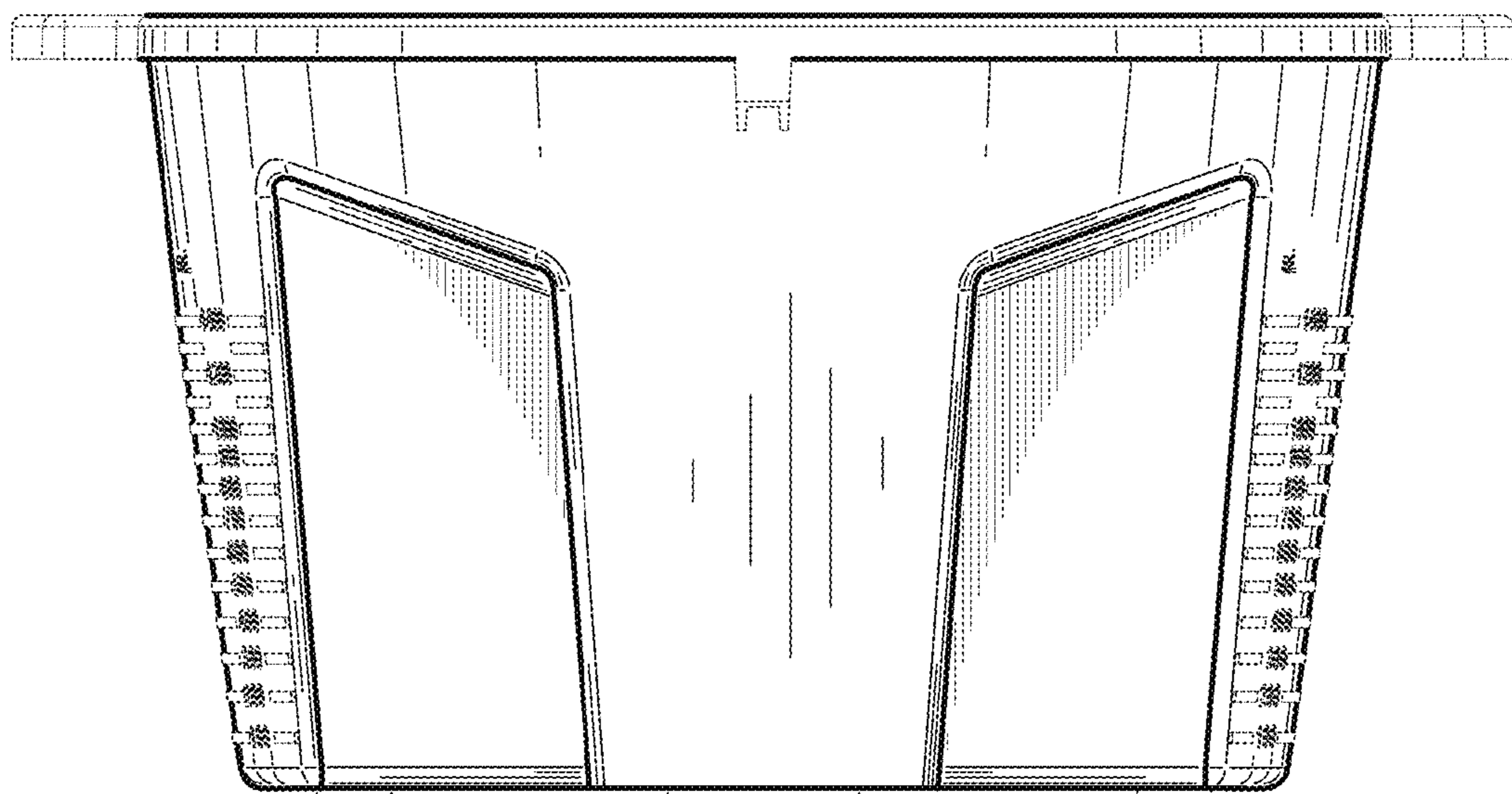

FIG. 4

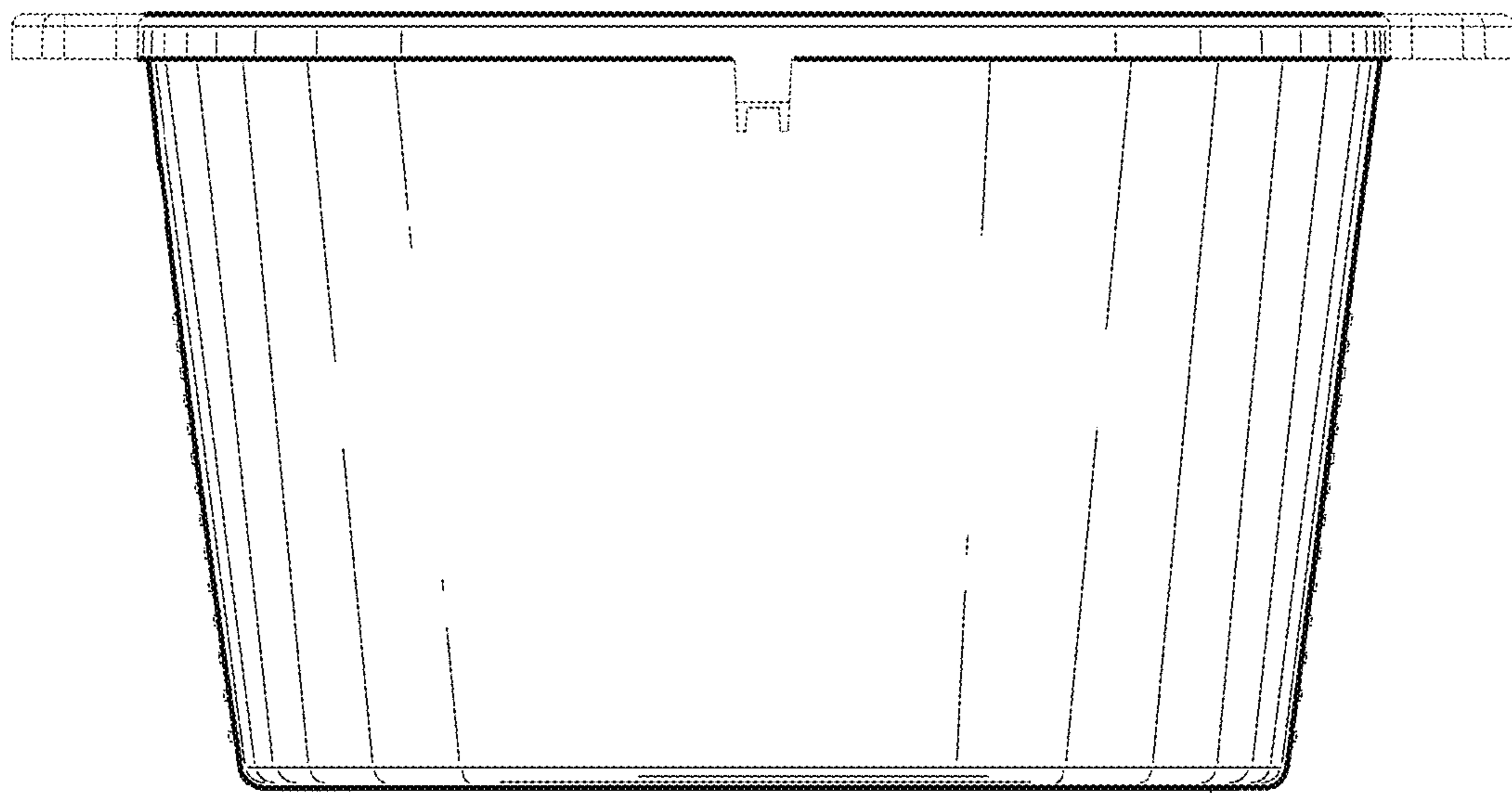

FIG. 5

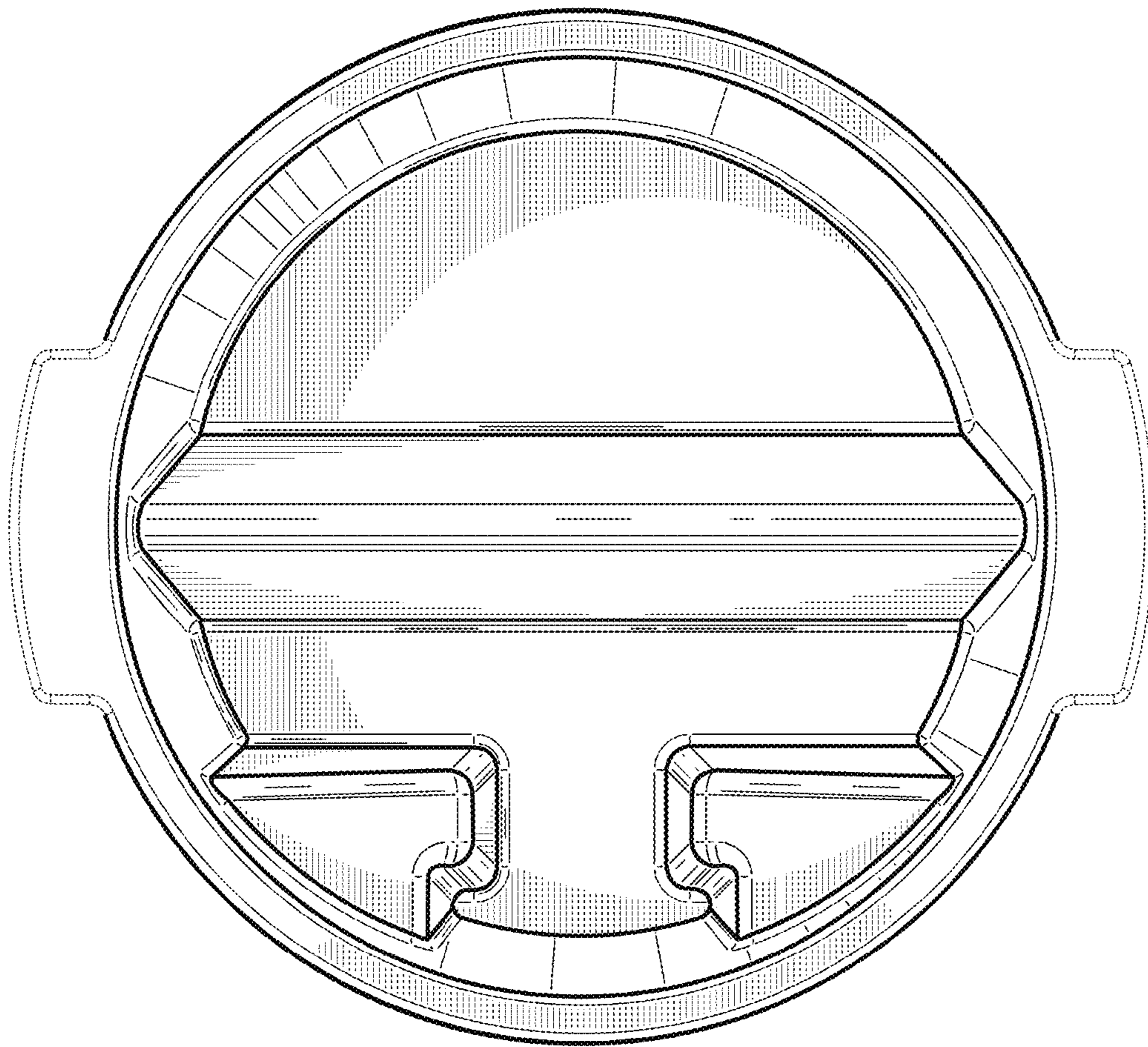

FIG. 6

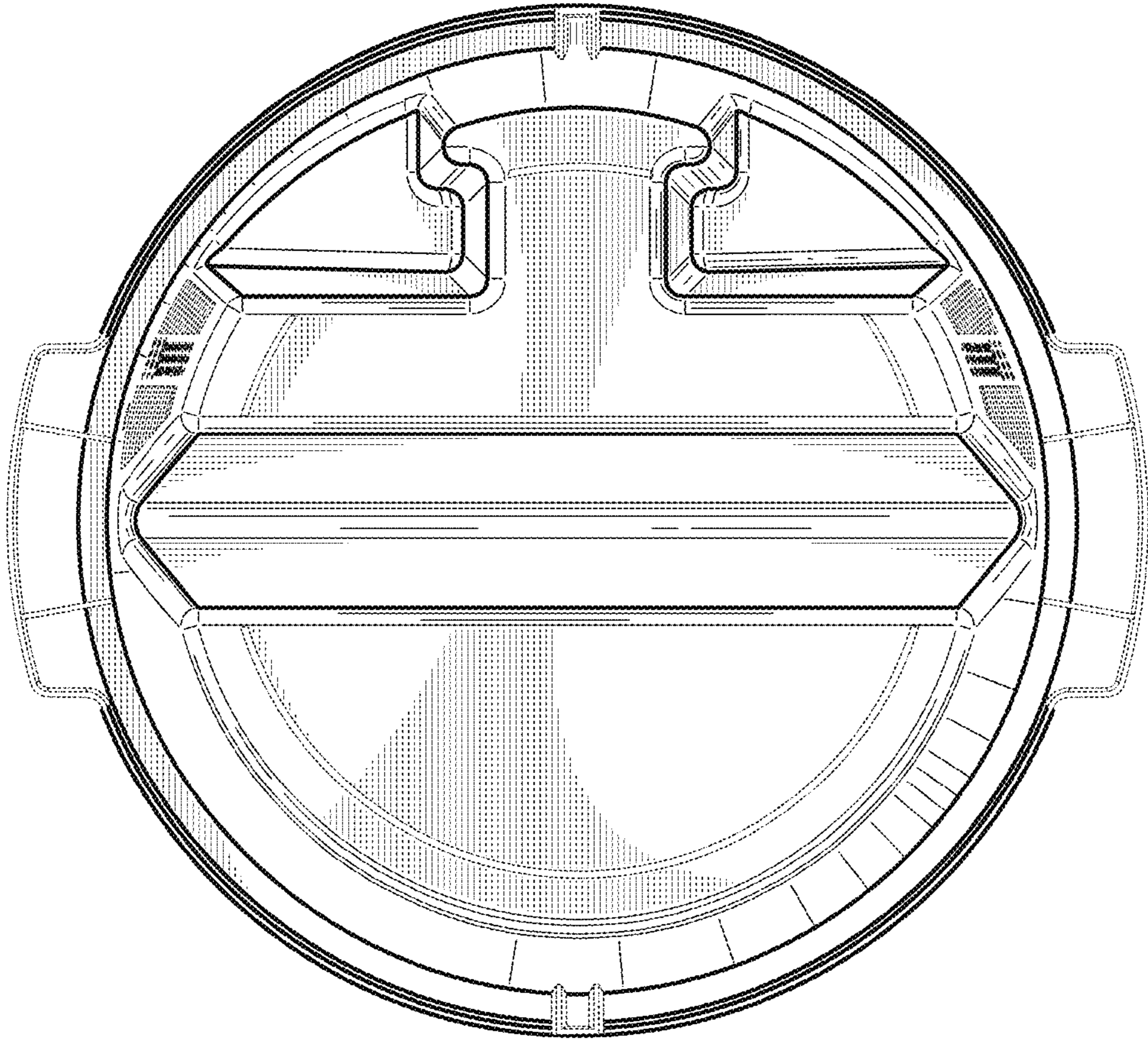

FIG. 7