



US00D771753S

(12) **United States Design Patent** (10) **Patent No.:** **US D771,753 S**
Billen (45) **Date of Patent:** **** Nov. 15, 2016**

(54) **3D POCKET PUZZLE**

(71) Applicant: **Kid Stuff Marketing, Inc.**, Topeka, KS (US)

(72) Inventor: **William D. Billen**, Topeka, KS (US)

(73) Assignee: **Kid Stuff Marketing, Inc.**, Topeka, KS (US)

(**) Term: **14 Years**

(21) Appl. No.: **29/524,834**

(22) Filed: **Apr. 23, 2015**

(51) **LOC (10) Cl.** **21-01**

(52) **U.S. Cl.**
USPC **D21/480**; D19/2

(58) **Field of Classification Search**
USPC D21/398, 487-480, 513-515, 811, 812;
D16/221, 222, 227, 229, 230, 231, 234,
D16/100, 300, 306, 309, 317, 325, 130,
D16/134; D19/1-11, 26, 28; D9/700, 701,
D9/702, 715, 721, 722, 737, 414, 415, 418,
D9/420, 432, 433, 499; D3/201, 227,
D3/247-249, 263, 265, 266, 274, 299,
D3/300; D20/19, 40, 43, 99; 229/92.8;
40/124.06

CPC A63F 9/001; A63F 9/06; A63F 9/0602;
A63F 9/0604; A63F 9/0613; A63F 9/10;
A63F 9/1011; A63F 2009/0662; A63F
2009/1016; A63F 2009/1022; A63F
2009/1055; A63F 2009/1083; A63F
2009/1088; A63F 2009/0012; A63F
2009/0016; A63F 2009/0033; A63F
2009/0036; A63F 2009/0039; A63F
2009/0044; A63F 2009/0049; A63F
2009/0059; A63F 2009/0609; A63F
2009/0618; A63F 2009/0622; A63F
2009/0629; A63F 2009/063; A63F
2009/0631; A63F 2250/02; A63H 33/042;
A63H 33/16; A63H 33/22; A63H 33/38;
G02C 3/00; G02C 3/04; G02C 5/001; G02C
5/006; G02C 5/008; G02C 5/2272; G02C

2200/12; G09F 1/04; G09F 1/08; G09F 1/12;
B42D 15/04; B42D 15/042; B42D 15/045;
B42D 15/047; B42D 15/08; B42D 15/085;
B65D 81/36; B65D 5/422; B65D 5/4229;
G02B 27/022; G02B 27/04; G02B 27/22;
G02B 27/2207; G02B 27/2221; G02B
27/2257

See application file for complete search history.

(56) **References Cited**

U.S. PATENT DOCUMENTS

1,413,123 A * 4/1922 Kearney B42D 15/0053
283/106
2,145,500 A * 1/1939 Townsend B42D 15/08
229/68.1
2,283,777 A * 5/1942 Wendling B42D 15/04
229/92.8

(Continued)

Primary Examiner — Catherine Tuttle

(74) *Attorney, Agent, or Firm* — Erickson Kernell IP, LLC

(57) **CLAIM**

The ornamental design for a 3D pocket puzzle, as shown and described.

DESCRIPTION

FIG. 1 is a plan view showing my new design for a 3D pocket puzzle in a flat, unfolded configuration; FIG. 2 is a rear view showing the design in a folded configuration; FIG. 3 is a front view thereof; FIG. 4 is a top view thereof; FIG. 5 is a bottom view thereof; FIG. 6 is a side view thereof; FIG. 7 is a top of the viewer element of the removable viewer element of the design; FIG. 8 is a front view thereof; FIG. 9 is a bottom view thereof; FIG. 10 is a rear view thereof; and, FIG. 11 is a side view thereof. The broken lines in FIGS. 1, 3 and 10 are for illustrative purposes only and form no part of the design.

1 Claim, 4 Drawing Sheets

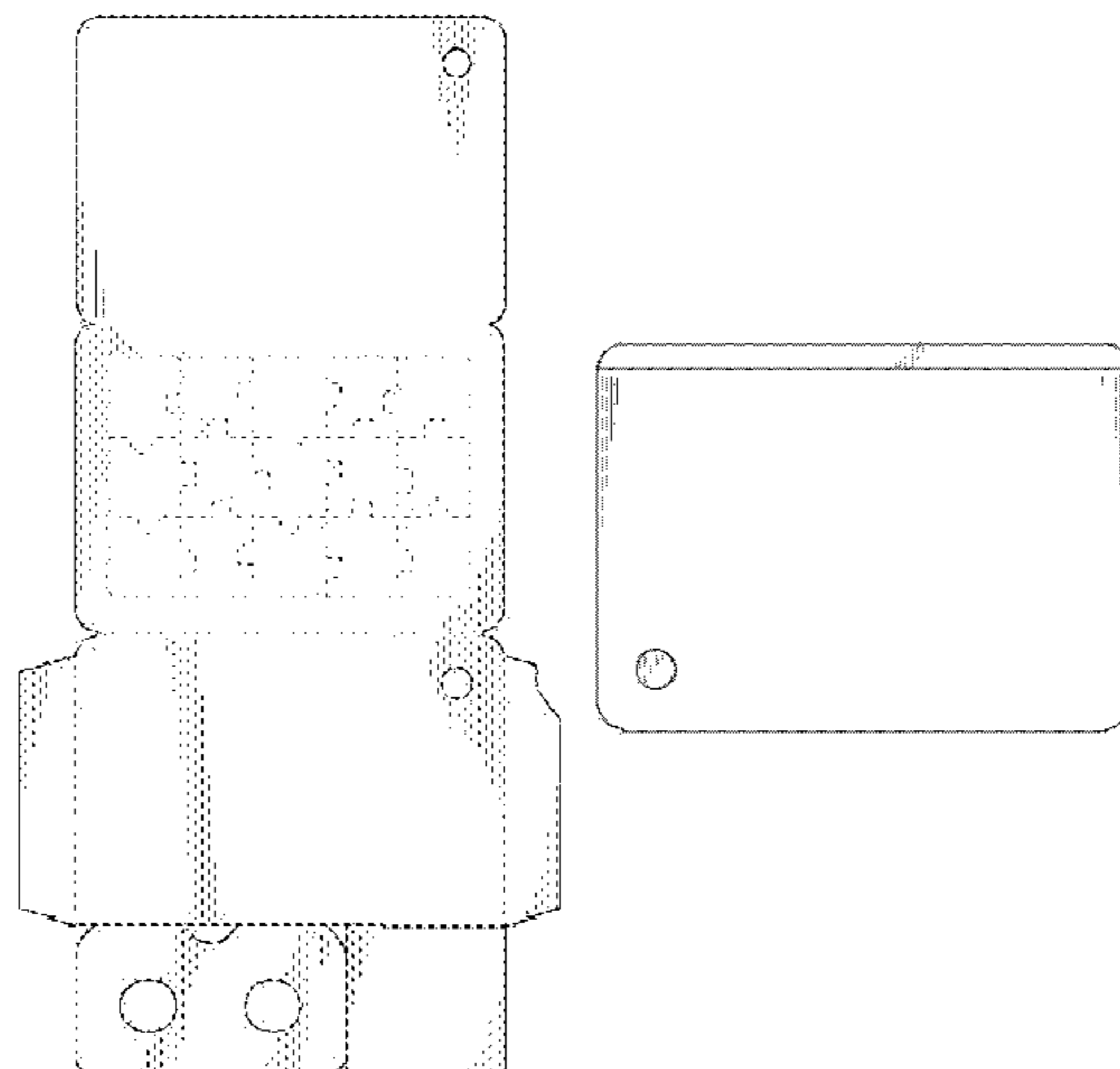

(56)

References Cited

U.S. PATENT DOCUMENTS

2,453,902 A *	11/1948	Graham	G09F 1/04 248/459	5,037,192 A *	8/1991	Arad	G02C 3/04 351/41
D153,296 S *	4/1949	Kauten	D16/222	5,133,496 A *	7/1992	Davidson	B65D 27/34 229/313
2,506,189 A *	5/1950	Attridge	A63F 9/1044 273/157 R	5,219,168 A *	6/1993	Morris	A63F 9/1044 273/157 R
D174,111 S *	3/1955	Crapsey	D16/222	5,865,928 A *	2/1999	Lariviere, Jr.	A63F 9/10 156/256
D183,267 S *	7/1958	Raber et al.	D16/229	5,938,014 A *	8/1999	Wilkinson	B65D 81/36 206/216
3,005,378 A *	10/1961	Golden	G02B 27/2257 220/6	D413,725 S *	9/1999	Hartmann	D19/26
3,512,780 A *	5/1970	Allison	A63F 3/069 273/139	D479,260 S *	9/2003	Hamamura	D16/222
3,964,750 A *	6/1976	Brown	A63F 9/10 273/157 R	7,815,190 B1 *	10/2010	Krisch	A63F 9/10 273/157 R
4,612,220 A *	9/1986	Baxter	B42D 15/042 156/227	2002/0092214 A1 *	7/2002	Girdler	G09F 1/04 40/124.06
D295,536 S *	5/1988	Forbes, Jr.	229/68.1	2004/0228989 A1 *	11/2004	Abramek	A63F 9/10 428/33
					2010/0110369 A1 *	5/2010	Bruce	G02C 3/04 351/158

* cited by examiner

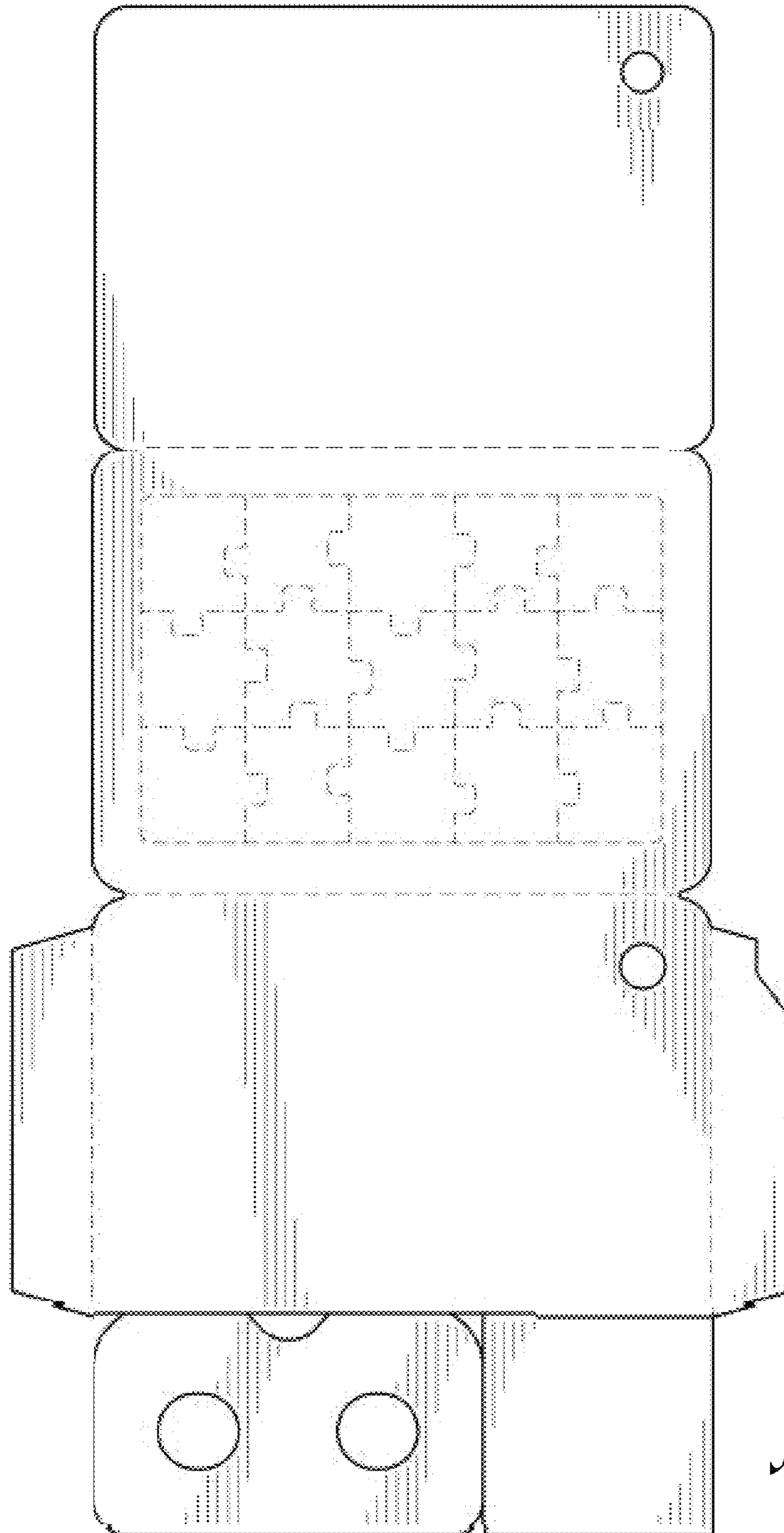

Fig. 1

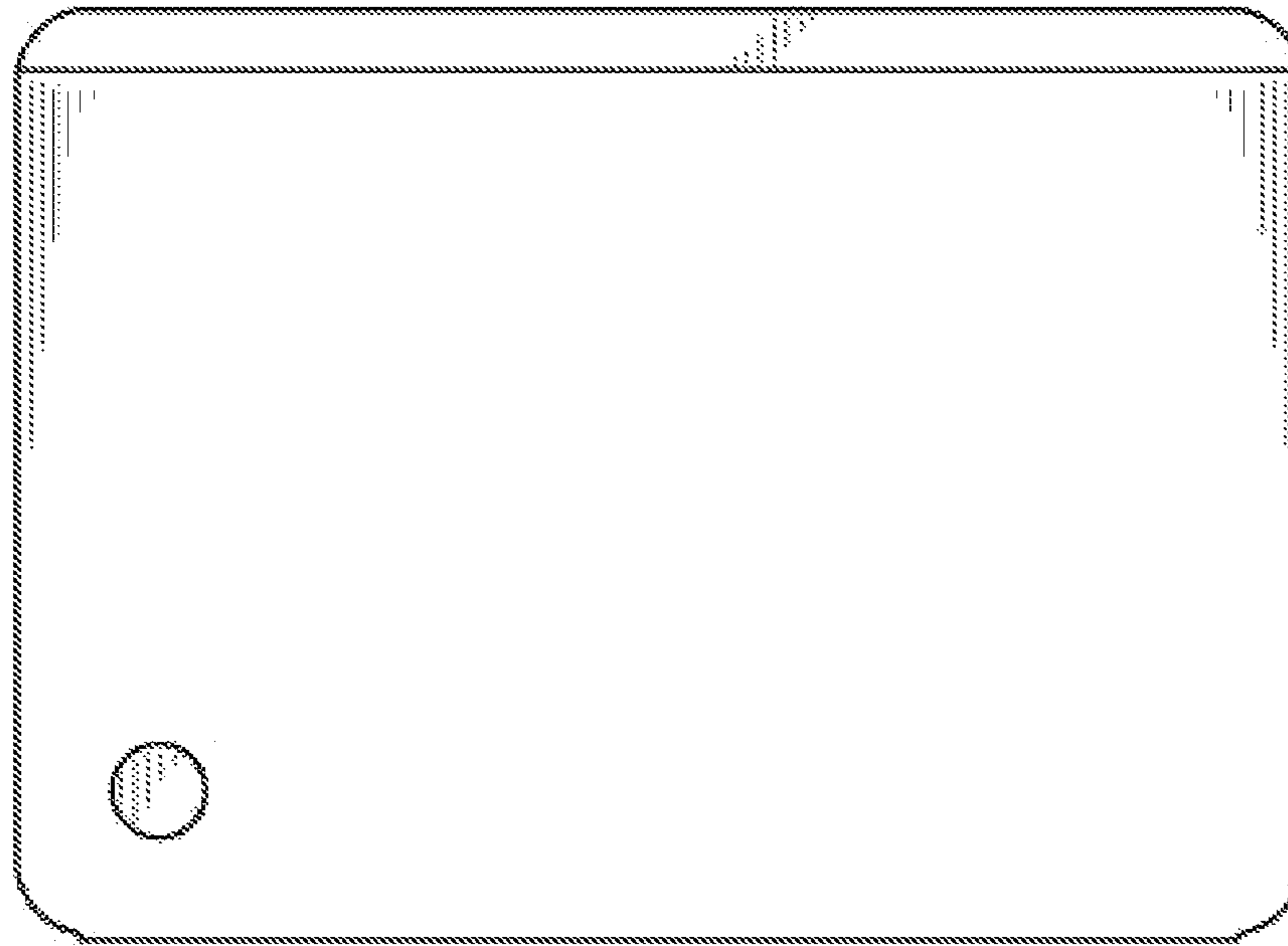

Fig. 2

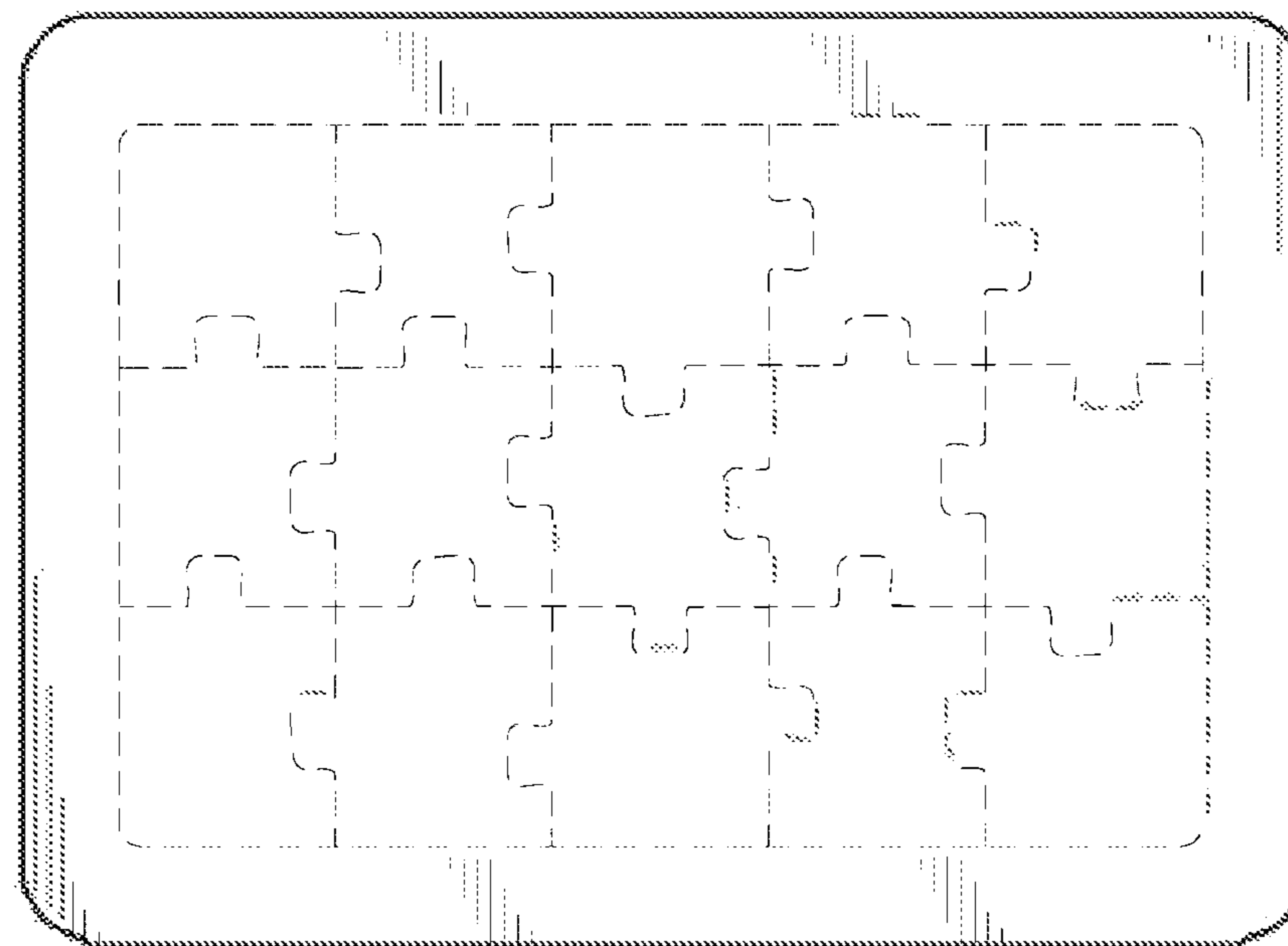

Fig. 3

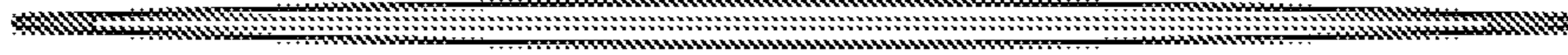

Fig. 4

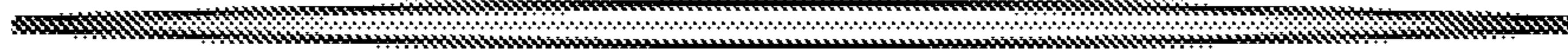

Fig. 5



Fig. 6

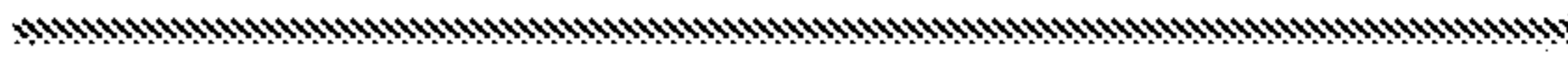

Fig. 7

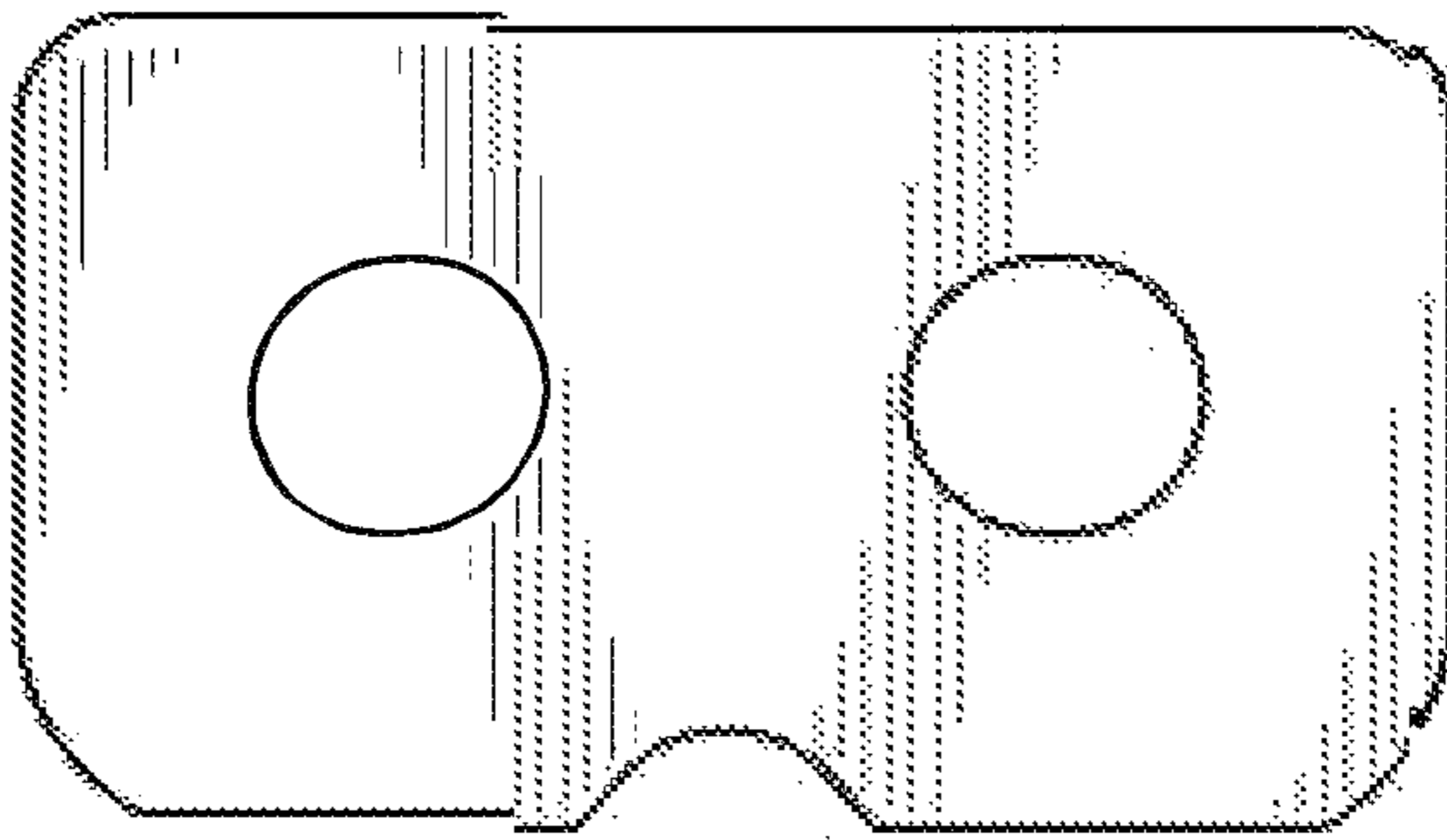

Fig. 8

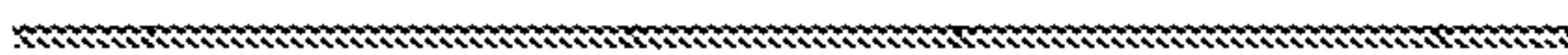

Fig. 9

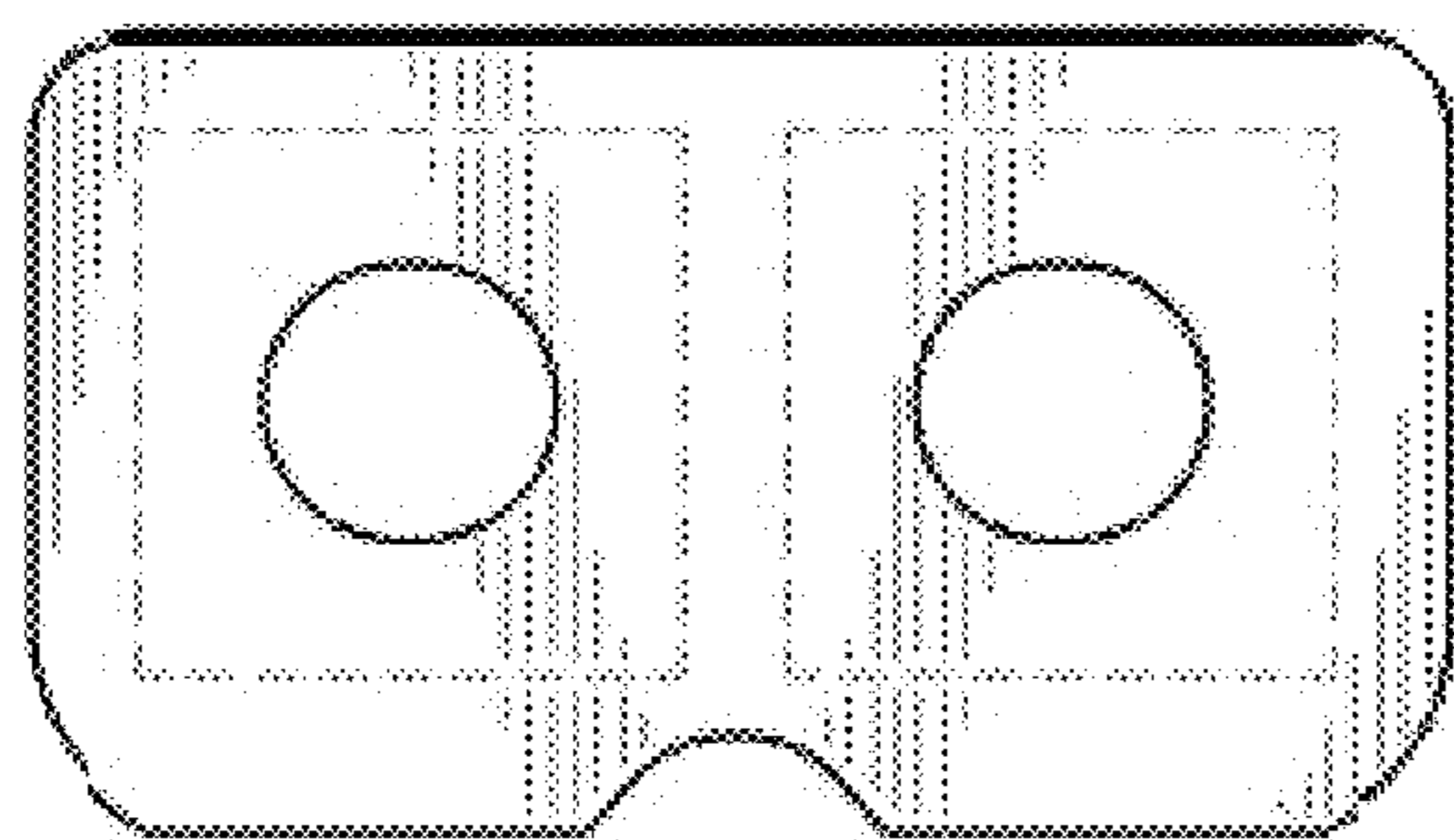

Fig. 10



Fig. 11