



US00D771743S

(12) **United States Design Patent**
Holanda

(10) **Patent No.:** **US D771,743 S**

(45) **Date of Patent:** **** Nov. 15, 2016**

(54) **GUITAR**

(71) Applicant: **Peter Holanda**, Modesto, CA (US)

(72) Inventor: **Peter Holanda**, Modesto, CA (US)

(**) Term: **15 Years**

(21) Appl. No.: **29/533,752**

(22) Filed: **Jul. 22, 2015**

(51) **LOC (10) Cl.** **17-03**

(52) **U.S. Cl.**
USPC **D17/20; D17/14**

(58) **Field of Classification Search**
USPC D6/691, 691.1, 695, 695.1, 697.1;
D11/89, 90; D17/14, 19, 20; 63/32;
84/298, 728

CPC G10D 1/00; G10D 1/08; G10D 1/085
See application file for complete search history.

(56) **References Cited**

U.S. PATENT DOCUMENTS

D62,378 S *	5/1923	Heller	D11/90
D254,182 S *	2/1980	Soika	D17/20
D503,122 S *	3/2005	Lichtenstein	D11/89
D593,892 S *	6/2009	Schneider	D11/89
D654,392 S *	2/2012	Granig	D11/90
D691,916 S *	10/2013	Stuchlik	D11/90

D707,586 S *	6/2014	Schweiger	D11/89
D727,784 S *	4/2015	Siman-tov	D11/90
D731,586 S *	6/2015	Gimpel	D17/20
D737,612 S *	9/2015	Nishikawa	D6/695
D753,537 S *	4/2016	Modi	D11/90

* cited by examiner

Primary Examiner — Robert M Spear

Assistant Examiner — Darcey E Heflin

(57) **CLAIM**

The ornamental design for a guitar, as shown and described.

DESCRIPTION

FIG. 1 is an rear perspective view of a guitar;

FIG. 2 is a side elevation view thereof;

FIG. 3 is an rear plan view thereof;

FIG. 4 is a side elevation view thereof;

FIG. 5 is a front plan view thereof;

FIG. 6 is a bottom elevation view thereof; and,

FIG. 7 is a top elevation view thereof.

In the drawings, the evenly-spaced broken lines showing portions of the guitar depict environment and form no part of the claim; the dash-dot-dot-dash lines represent boundaries of the claimed design and form no part thereof.

1 Claim, 3 Drawing Sheets

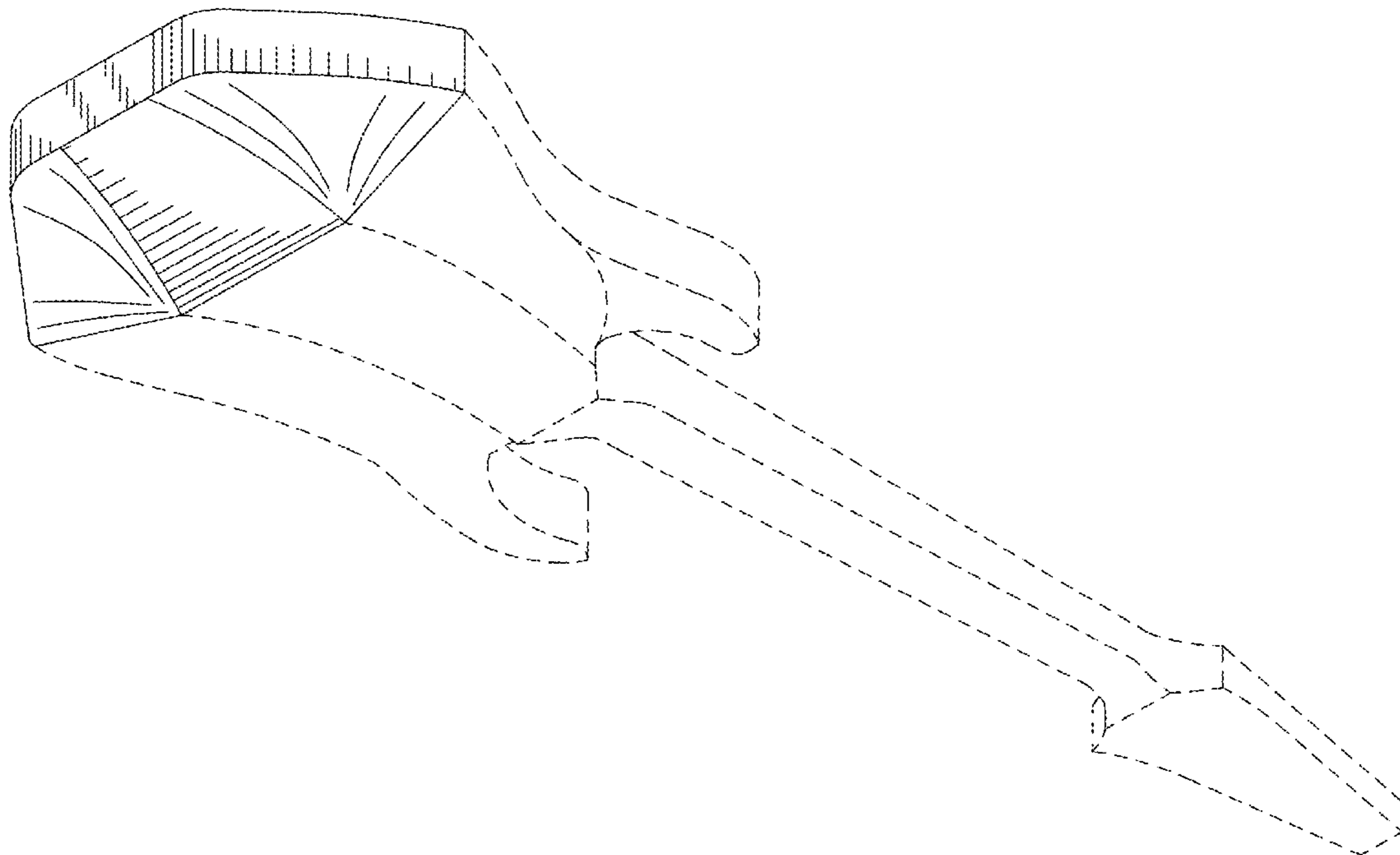

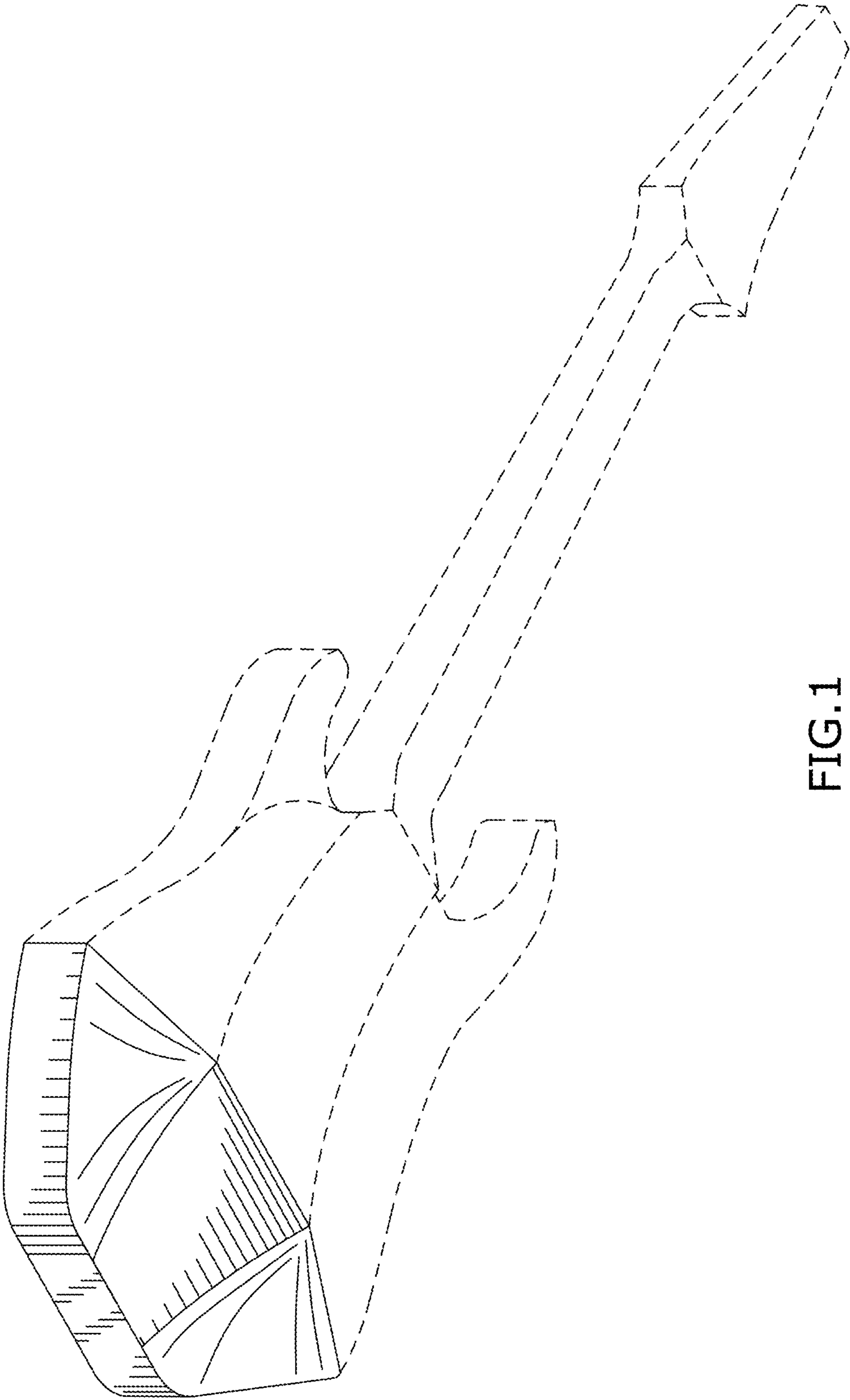

FIG.1

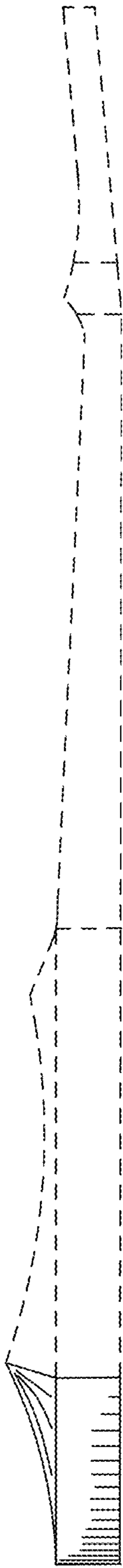

FIG. 2

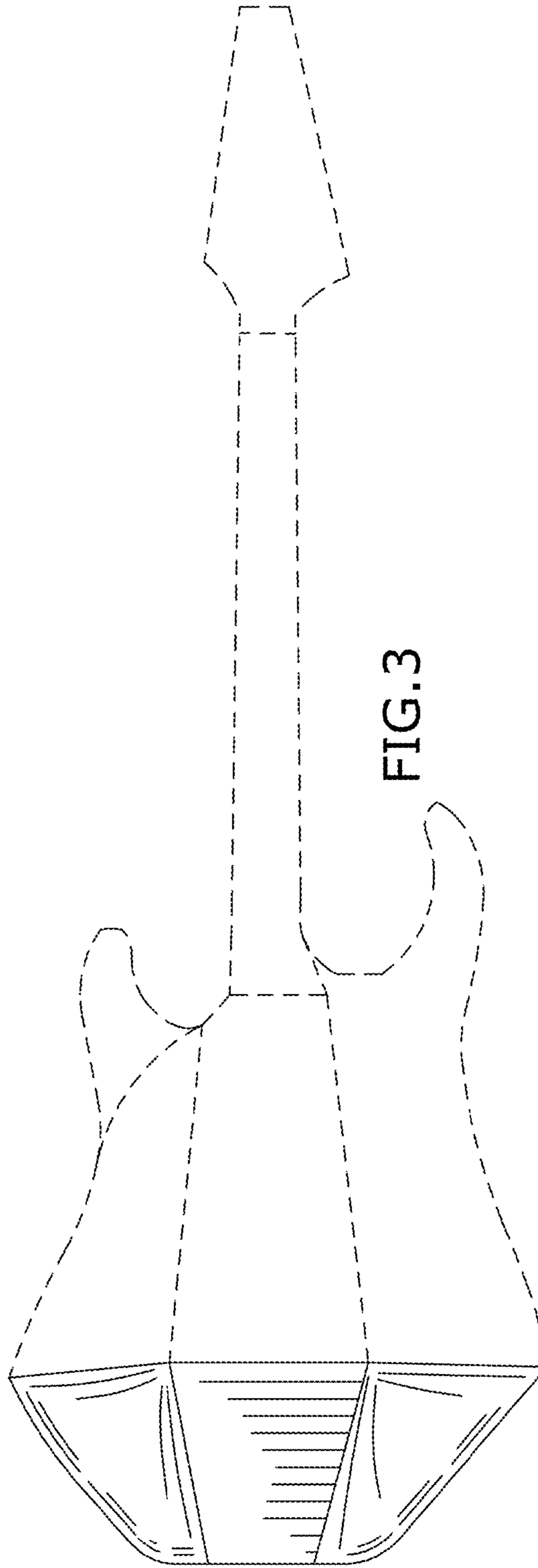

FIG. 3

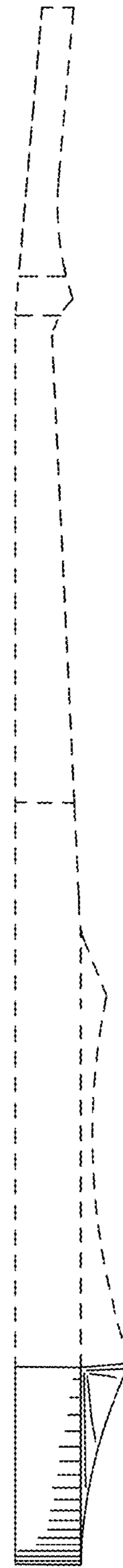

FIG. 4

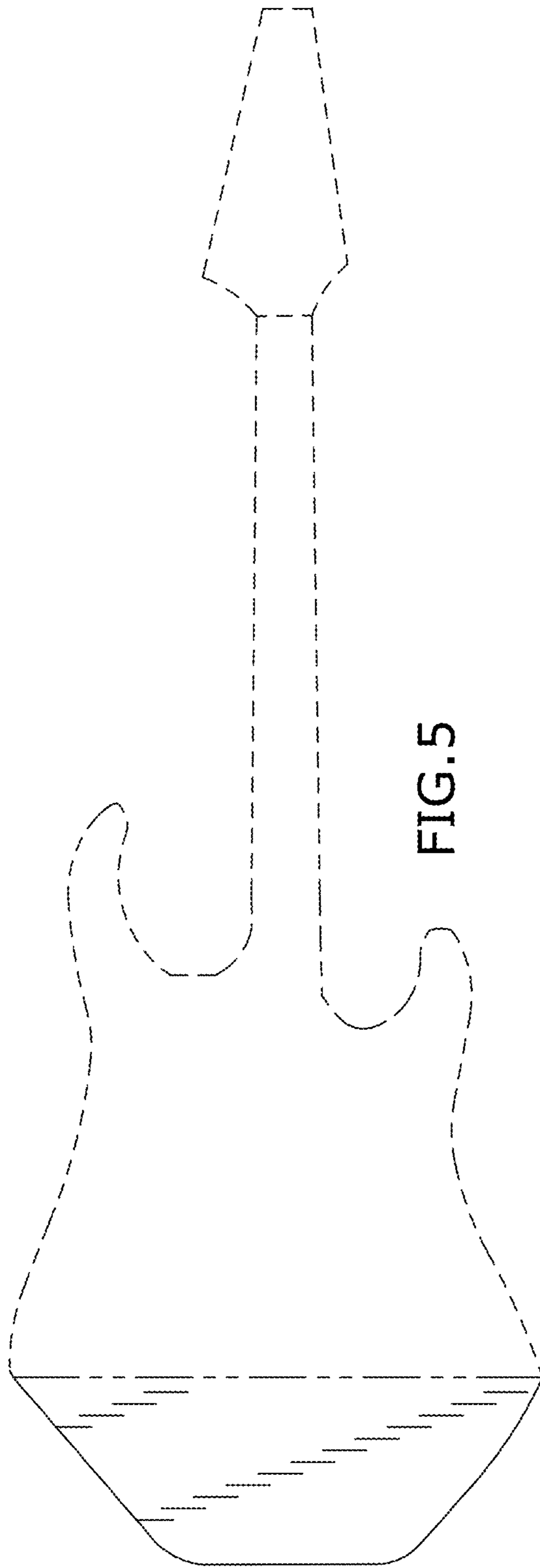

FIG. 5

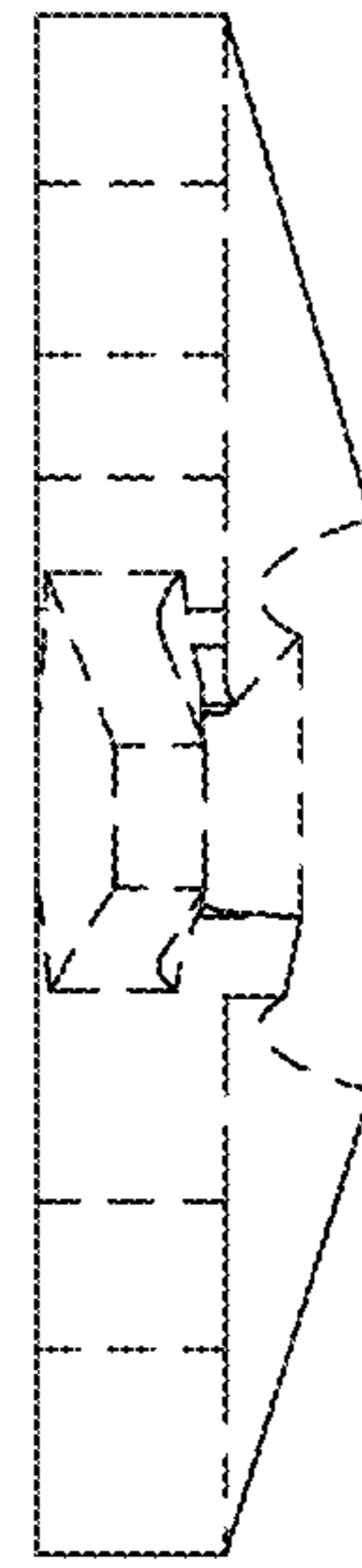

FIG. 7



FIG. 6