



US00D771712S

(12) **United States Design Patent** (10) **Patent No.:** **US D771,712 S**  
**Ootake et al.** (45) **Date of Patent:** **\*\* Nov. 15, 2016**

(54) **ROTATIONAL PUMP**

(74) *Attorney, Agent, or Firm* — Nixon & Vanderhye P.C.

(71) Applicant: **DENSO CORPORATION**, Kariya, Aichi-pref. (JP)

(57) **CLAIM**

The ornamental design for a rotational pump, as shown and described.

(72) Inventors: **Masaya Ootake**, Kariya (JP); **Yuuji Hidaka**, Chiryu (JP);  
(Continued)

**DESCRIPTION**

(73) Assignee: **DENSO CORPORATION**, Kariya (JP)

FIG. 1 is a first perspective view of a rotational pump of a first new design;

(\*\*) Term: **14 Years**

FIG. 2 is a second perspective view of the rotational pump shown in FIG. 1;

(21) Appl. No.: **29/526,217**

FIG. 3 is a front view of the rotational pump shown in FIG. 1;

(22) Filed: **May 7, 2015**

FIG. 4 is a back view of the rotational pump shown in FIG. 1;

(30) **Foreign Application Priority Data**

Nov. 19, 2014 (JP) ..... 2014-25756

FIG. 5 is a left side view of the rotational pump shown in FIG. 1;

Nov. 19, 2014 (JP) ..... 2014-25757

FIG. 6 is a right side view of the rotational pump shown in FIG. 1;

(Continued)

FIG. 7 is a top view of the rotational pump shown in FIG. 1;

(51) **LOC (10) Cl.** ..... **15-02**

FIG. 8 is a bottom view of the rotational pump shown in FIG. 1;

(52) **U.S. Cl.**

USPC ..... **D15/7**

FIG. 9 is a left side view for a reference of the rotational pump shown in FIG. 1;

(58) **Field of Classification Search**

USPC ..... D15/7-9, 5, 9.1; D23/231, 232, 225;

417/60, 235, 265, 321, 355, 358, 363,

(Continued)

FIG. 10 is a cross-sectional view for a reference of the rotational pump, taken along the line X-X in FIG. 9;

(56) **References Cited**

**U.S. PATENT DOCUMENTS**

5,007,806 A \* 4/1991 Bellis ..... F02M 37/08

123/509

D329,651 S \* 9/1992 Kuwada ..... D15/5

(Continued)

FIG. 11 is a first perspective view of a rotational pump of a second new design similarly to the first new design;

FIG. 12 is a second perspective view of the rotational pump shown in FIG. 11;

FIG. 13 is a front view of the rotational pump shown in FIG. 11;

FIG. 14 is a back view of the rotational pump shown in FIG. 11;

FIG. 15 is a left side view of the rotational pump shown in FIG. 11;

FIG. 16 is a right side view of the rotational pump shown in FIG. 11;

FIG. 17 is a top view of the rotational pump shown in FIG. 11;

Ootake et al., U.S. Appl. No. 29/526,222, entitled "Rotational Pump", filed May 7, 2015.

*Primary Examiner* — Ralf Seifert

(Continued)

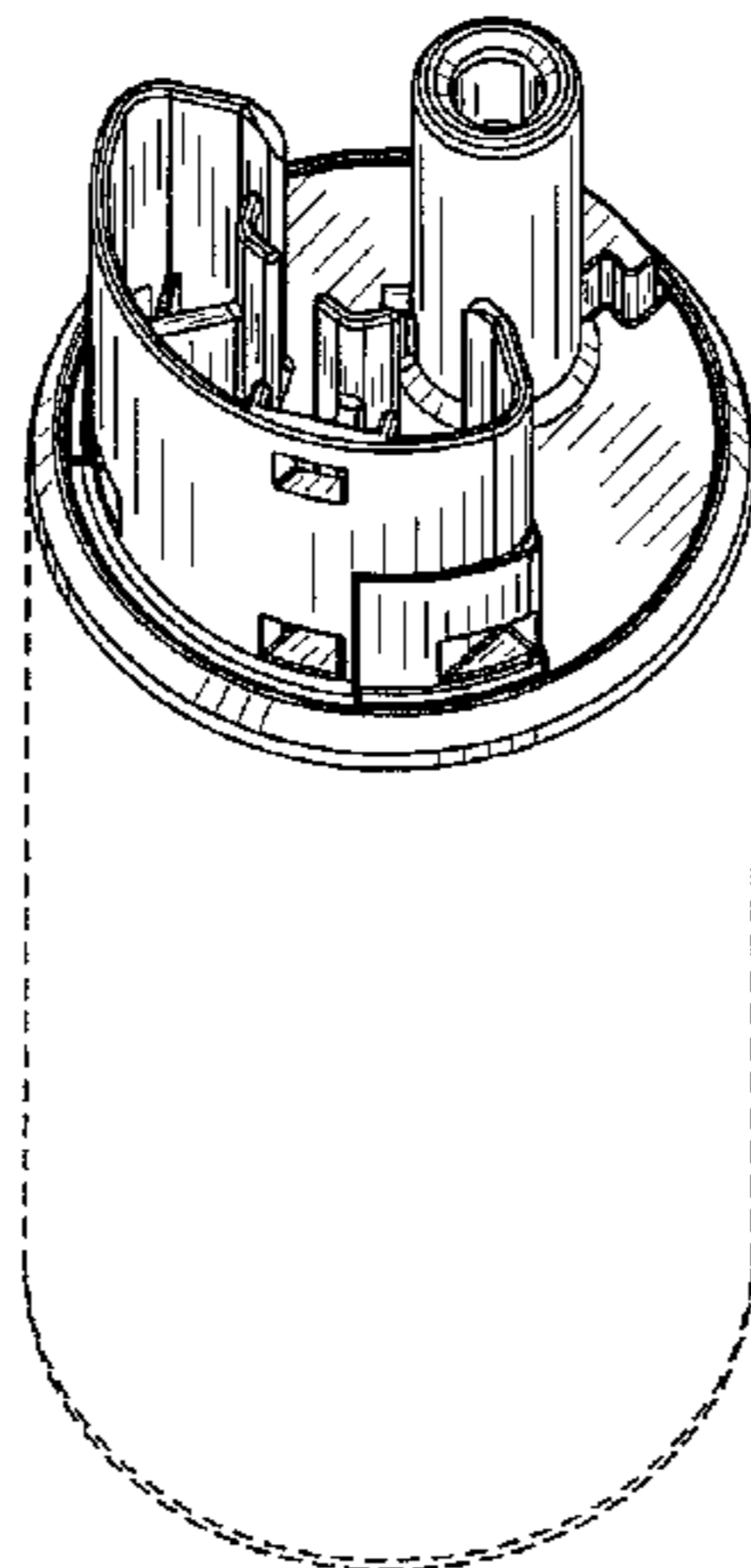

FIG. 18 is a bottom view of the rotational pump shown in FIG. 11;  
 FIG. 19 is a left side view for a reference of the rotational pump shown in FIG. 11;  
 FIG. 20 is a cross-sectional view for a reference of the rotational pump, taken along the line XX-XX in FIG. 19;  
 FIG. 21 is a first perspective view of a rotational pump of a third new design similar to the first and second new designs;  
 FIG. 22 is a second perspective view of the rotational pump shown in FIG. 21;  
 FIG. 23 is a front view of the rotational pump shown in FIG. 21;  
 FIG. 24 is a back view of the rotational pump shown in FIG. 21;  
 FIG. 25 is a left side view of the rotational pump shown in FIG. 21;  
 FIG. 26 is a right side view of the rotational pump shown in FIG. 21;  
 FIG. 27 is a top view of the rotational pump shown in FIG. 21;  
 FIG. 28 is a bottom view of the rotational pump shown in FIG. 21;  
 FIG. 29 is a left side view for a reference of the rotational pump shown in FIG. 21;  
 FIG. 30 is a cross-sectional view for a reference of the rotational pump, taken along the line XXX-XXX in FIG. 29;  
 FIG. 31 is a first perspective view of a rotational pump of a fourth new design similar to the first to third new designs;  
 FIG. 32 is a second perspective view of the rotational pump shown in FIG. 31;  
 FIG. 33 is a front view of the rotational pump shown in FIG. 31;  
 FIG. 34 is a back view of the rotational pump shown in FIG. 31;  
 FIG. 35 is a left side view of the rotational pump shown in FIG. 31;  
 FIG. 36 is a right side view of the rotational pump shown in FIG. 31;  
 FIG. 37 is a top view of the rotational pump shown in FIG. 31;  
 FIG. 38 is a bottom view of the rotational pump shown in FIG. 31;  
 FIG. 39 is a left side view for a reference of the rotational pump shown in FIG. 31;  
 FIG. 40 is a cross-sectional view for a reference of the rotational pump, taken along the line XL-XL in FIG. 39;  
 FIG. 41 is a first perspective view of a rotational pump of a fifth new design similar to the first to fourth new designs;  
 FIG. 42 is a second perspective view of the rotational pump shown in FIG. 41;  
 FIG. 43 is a front view of the rotational pump shown in FIG. 41;

FIG. 44 is a back view of the rotational pump shown in FIG. 41;  
 FIG. 45 is a left side view of the rotational pump shown in FIG. 41;  
 FIG. 46 is a right side view of the rotational pump shown in FIG. 41;  
 FIG. 47 is a top view of the rotational pump shown in FIG. 41;  
 FIG. 48 is a bottom view of the rotational pump shown in FIG. 41;  
 FIG. 49 is a left side view for a reference of the rotational pump shown in FIG. 41; and,  
 FIG. 50 is a cross-sectional view for a reference of the rotational pump, taken along the line L-L in FIG. 49.  
 The article of the present designs relate to a rotational pump for supplying fuel to an internal combustion engine or the like.  
 The broken lines shown in the drawings form no part of claimed design.

**1 Claim, 38 Drawing Sheets**

(72) Inventors: **Kiyoshi Nagata**, Nagoya (JP); **Tetsuo Hayakawa**, Kariya (JP)

(30) **Foreign Application Priority Data**

Nov. 19, 2014 (JP) ..... 2014-25758  
 Nov. 19, 2014 (JP) ..... 2014-25759  
 Nov. 19, 2014 (JP) ..... 2014-25760

(58) **Field of Classification Search**

USPC ..... 417/359, 410.1, 415-416, 405, 900;  
 60/408, 412; 184/26-37; 415/140-147;  
 123/495, 509; 137/565.34  
 CPC ..... F02M 37/04; F02M 37/14  
 See application file for complete search history.

(56) **References Cited**

U.S. PATENT DOCUMENTS

D331,239 S \* 11/1992 Iwai ..... D15/7  
 D332,266 S \* 1/1993 Iwai ..... D15/7  
 D332,267 S \* 1/1993 Iwai ..... D15/7  
 D333,475 S \* 2/1993 Kuwada ..... D15/5  
 D368,099 S \* 3/1996 Stenborg ..... D15/9.1  
 D373,365 S \* 9/1996 Schoenmeyr ..... D15/7  
 6,227,819 B1 \* 5/2001 Gettel ..... B01D 35/027  
 415/55.1  
 D655,312 S 3/2012 Koyama et al.  
 D680,134 S \* 4/2013 Fordyce ..... D15/7  
 D696,300 S \* 12/2013 Arotzarena ..... D15/7  
 D696,694 S \* 12/2013 Fulkerson ..... D15/7

\* cited by examiner

FIG. 1

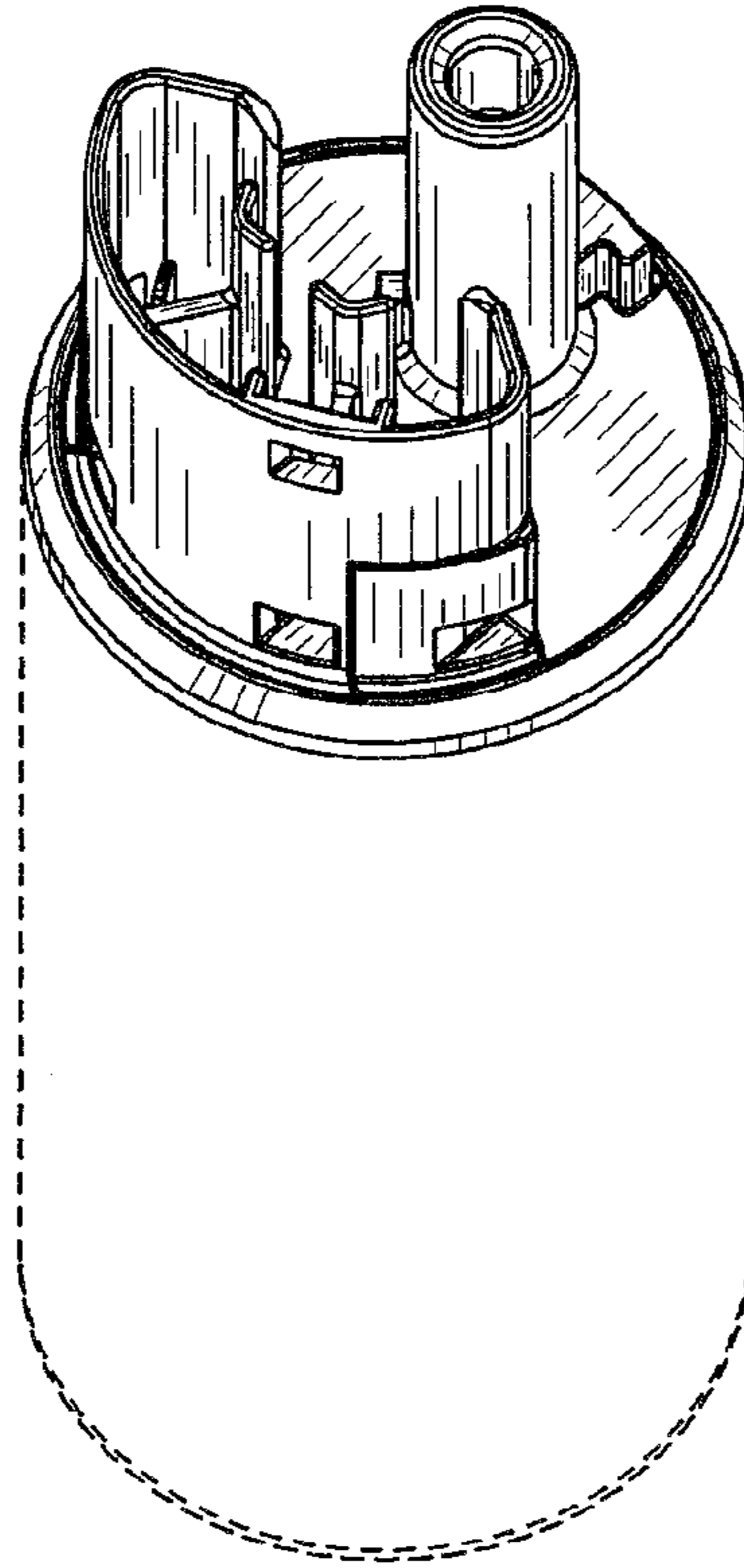

FIG. 2

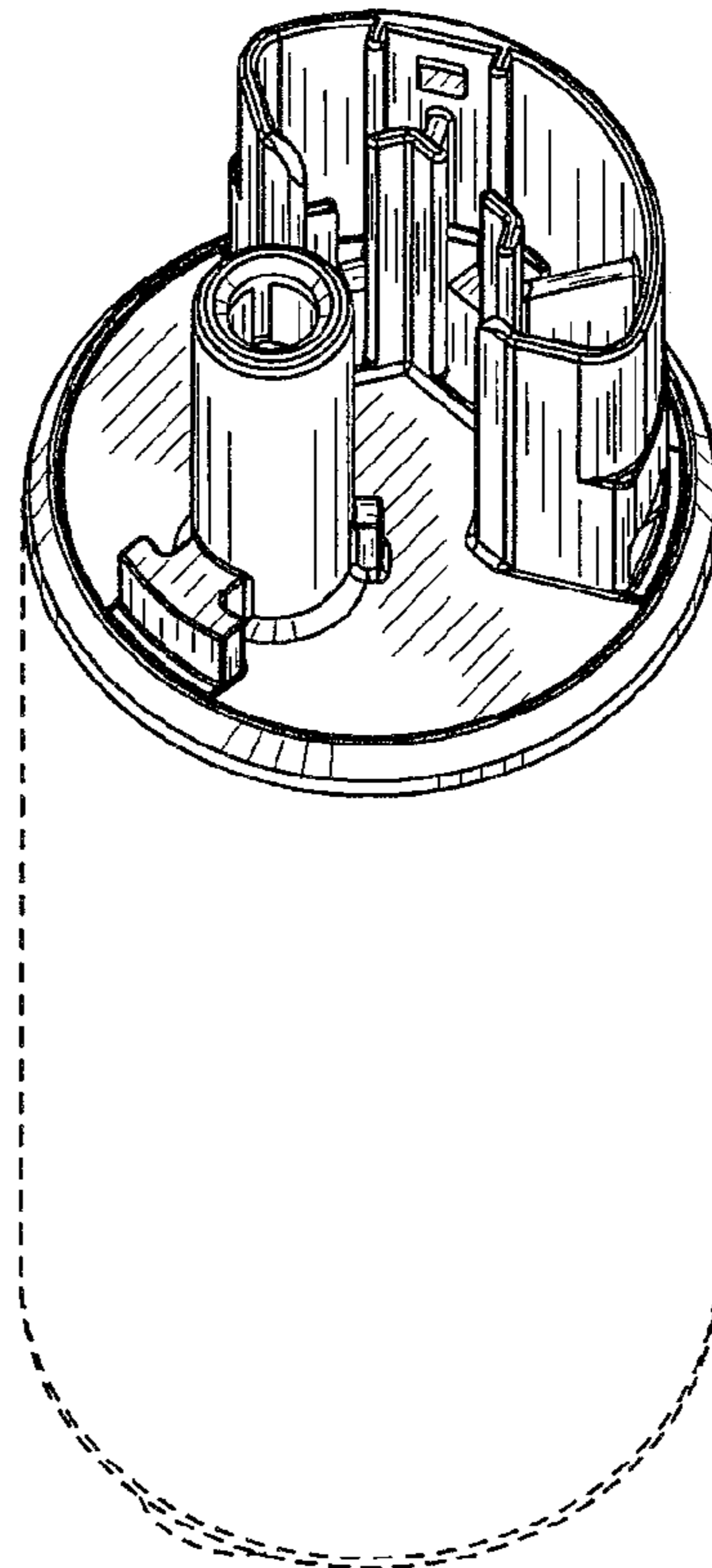

FIG. 3

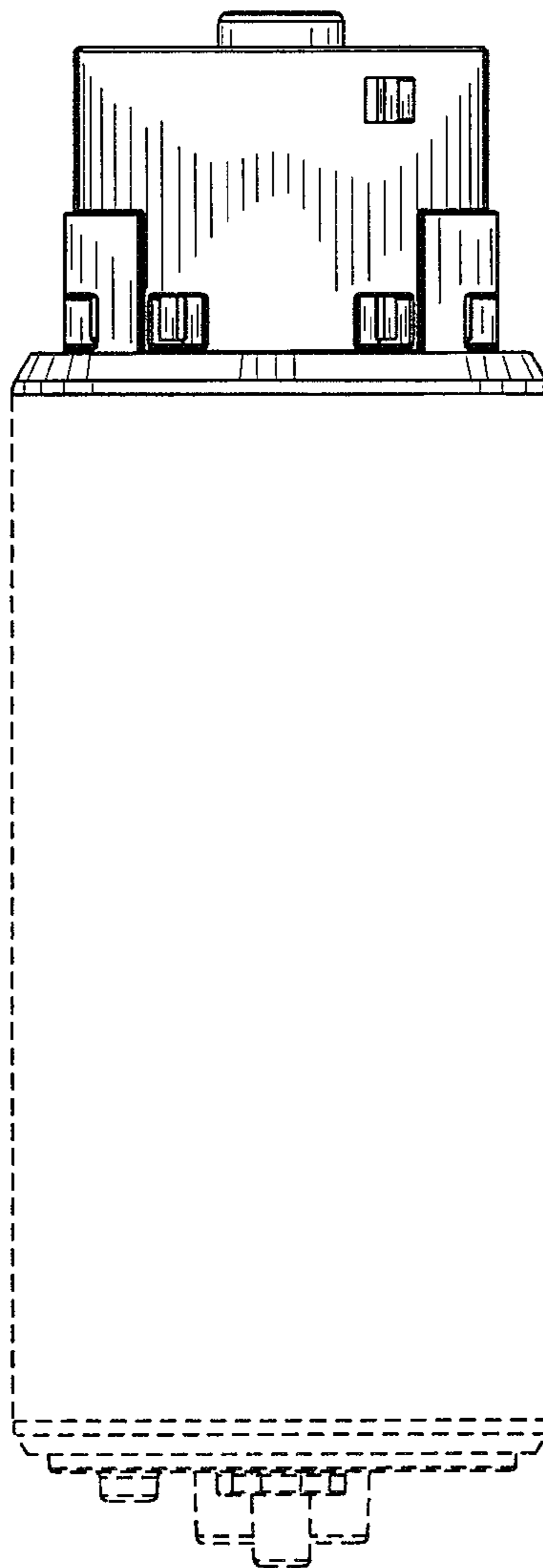

FIG. 4

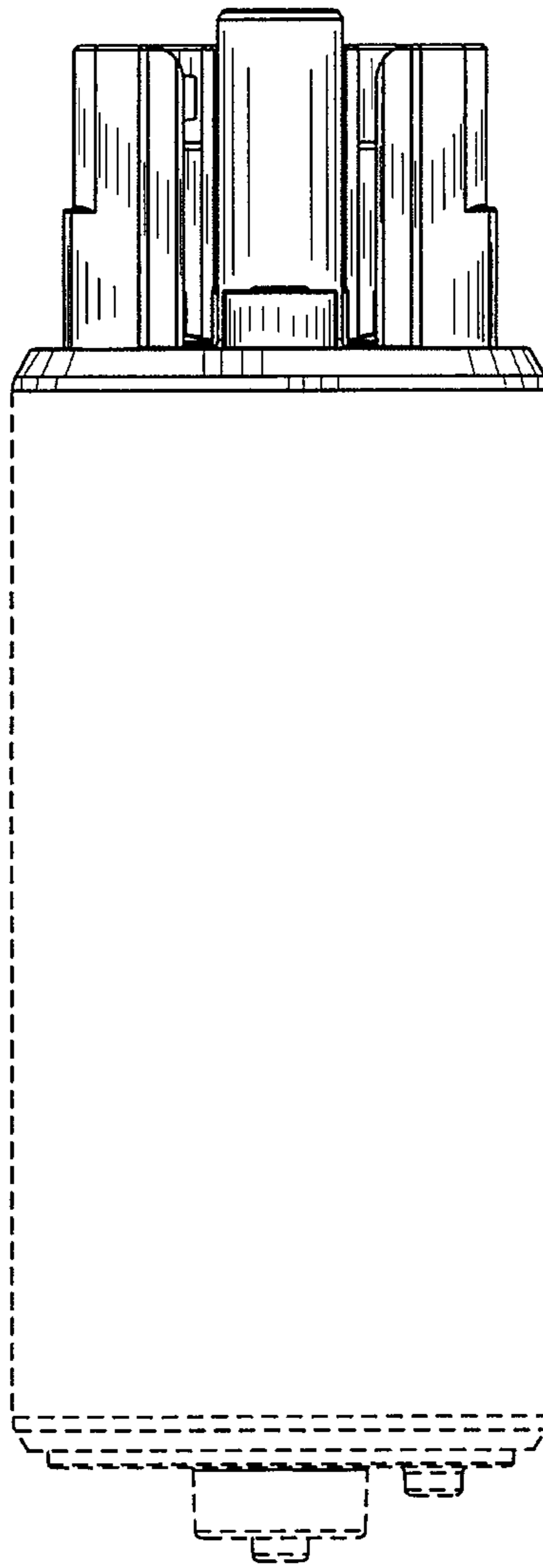

FIG. 5

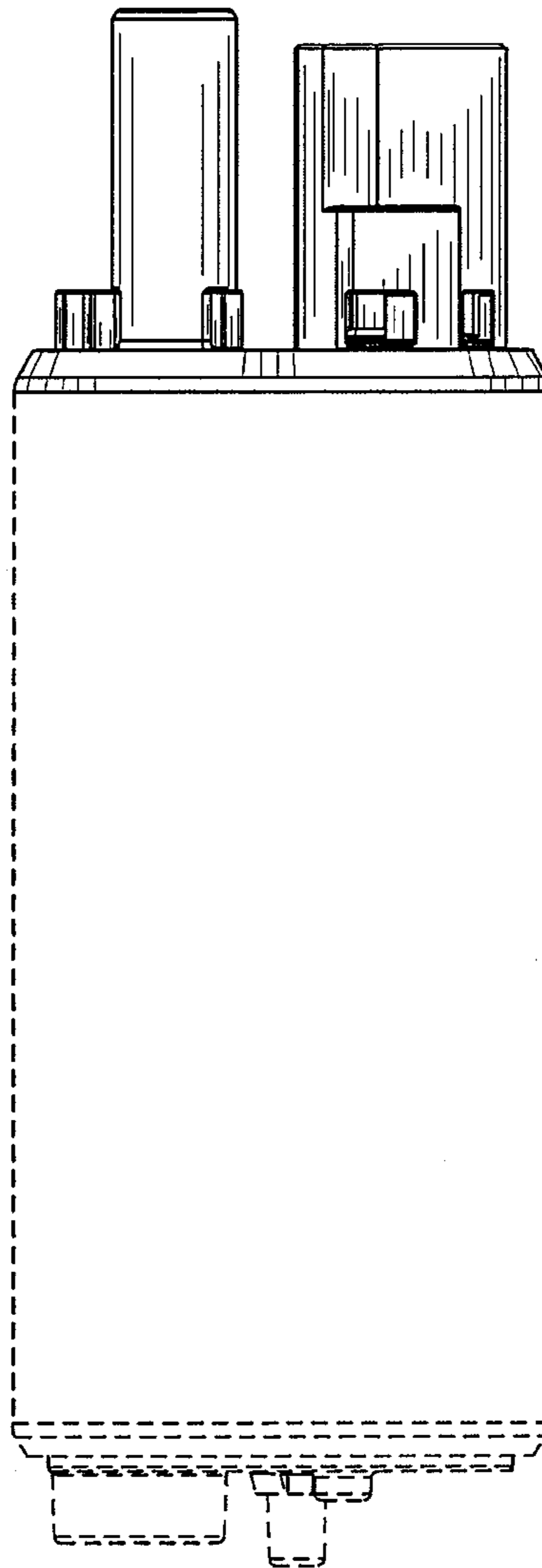

FIG. 6

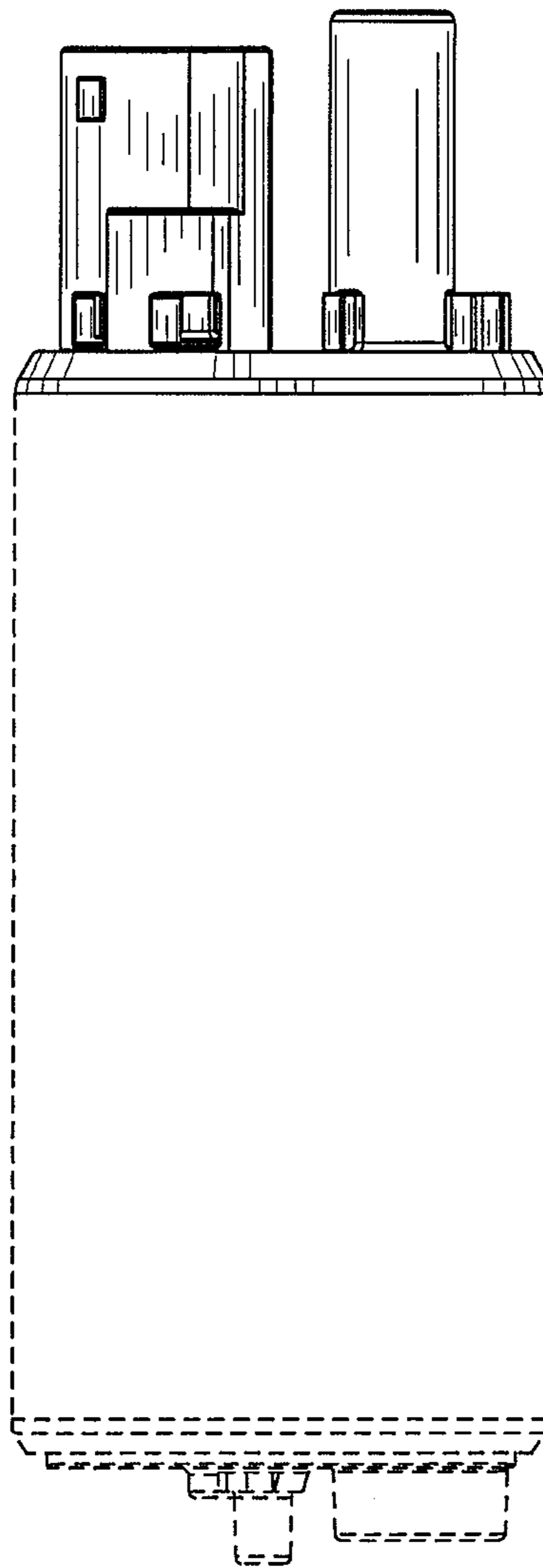

FIG. 7

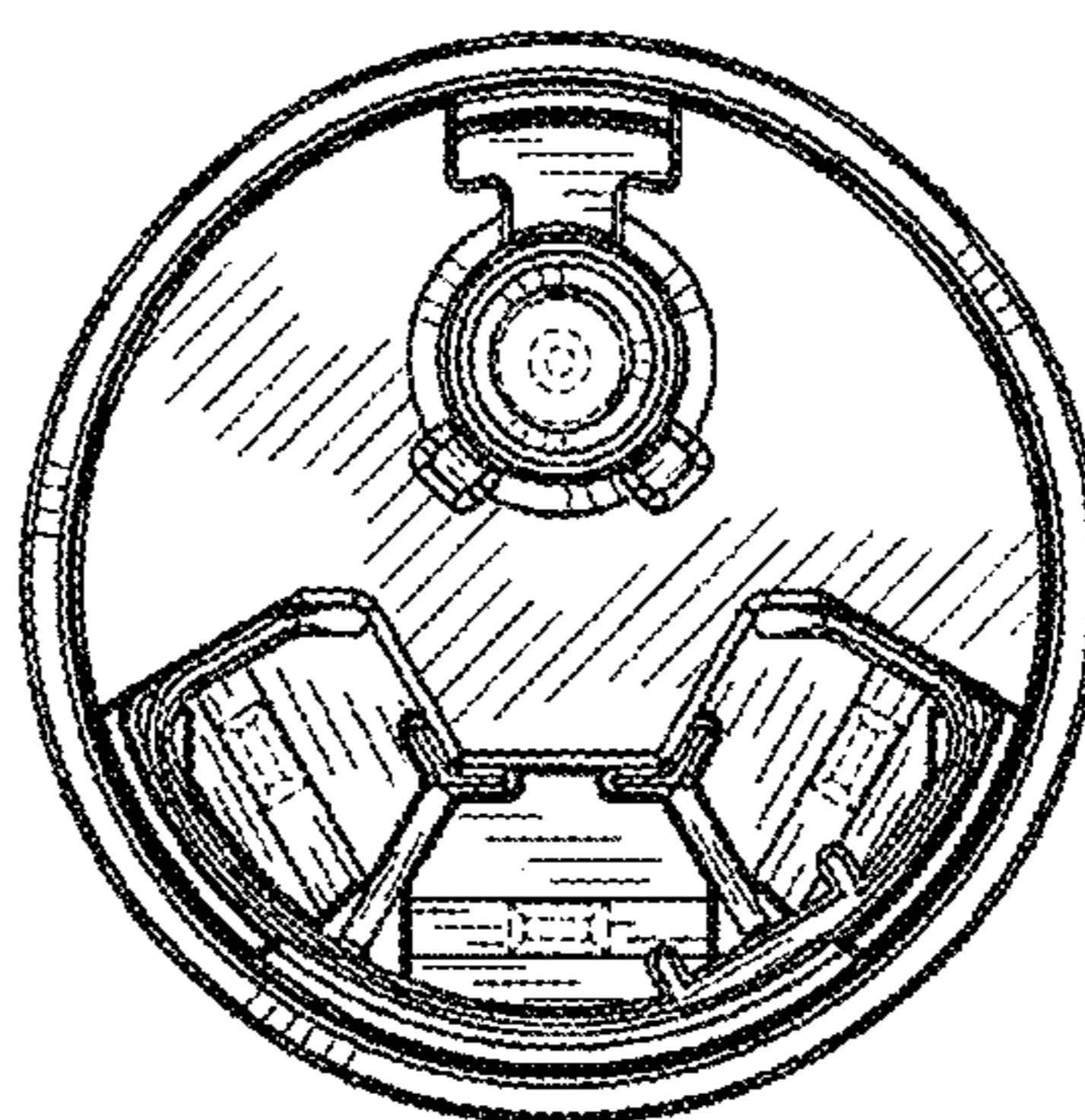

FIG. 8

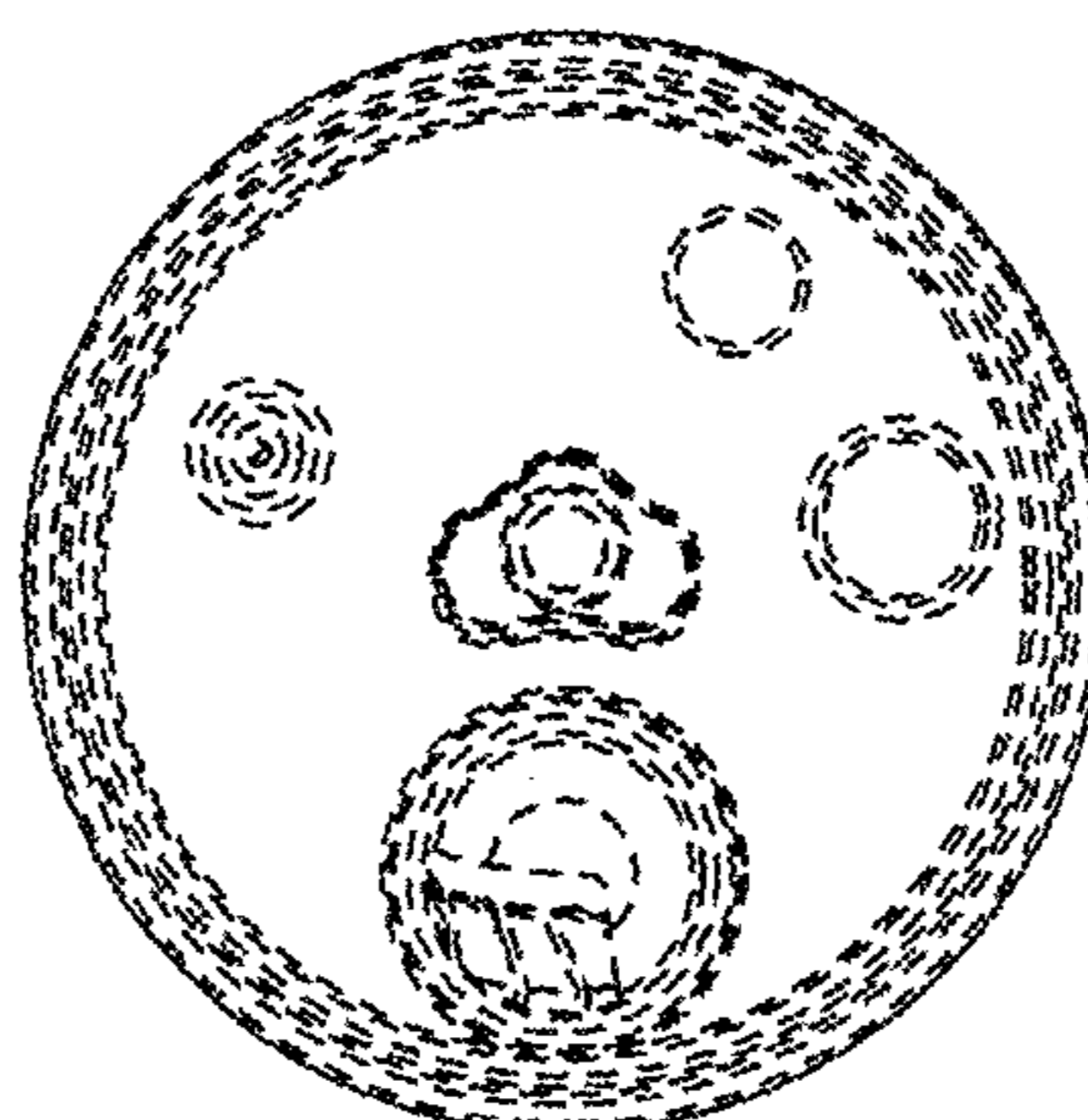



FIG. 9

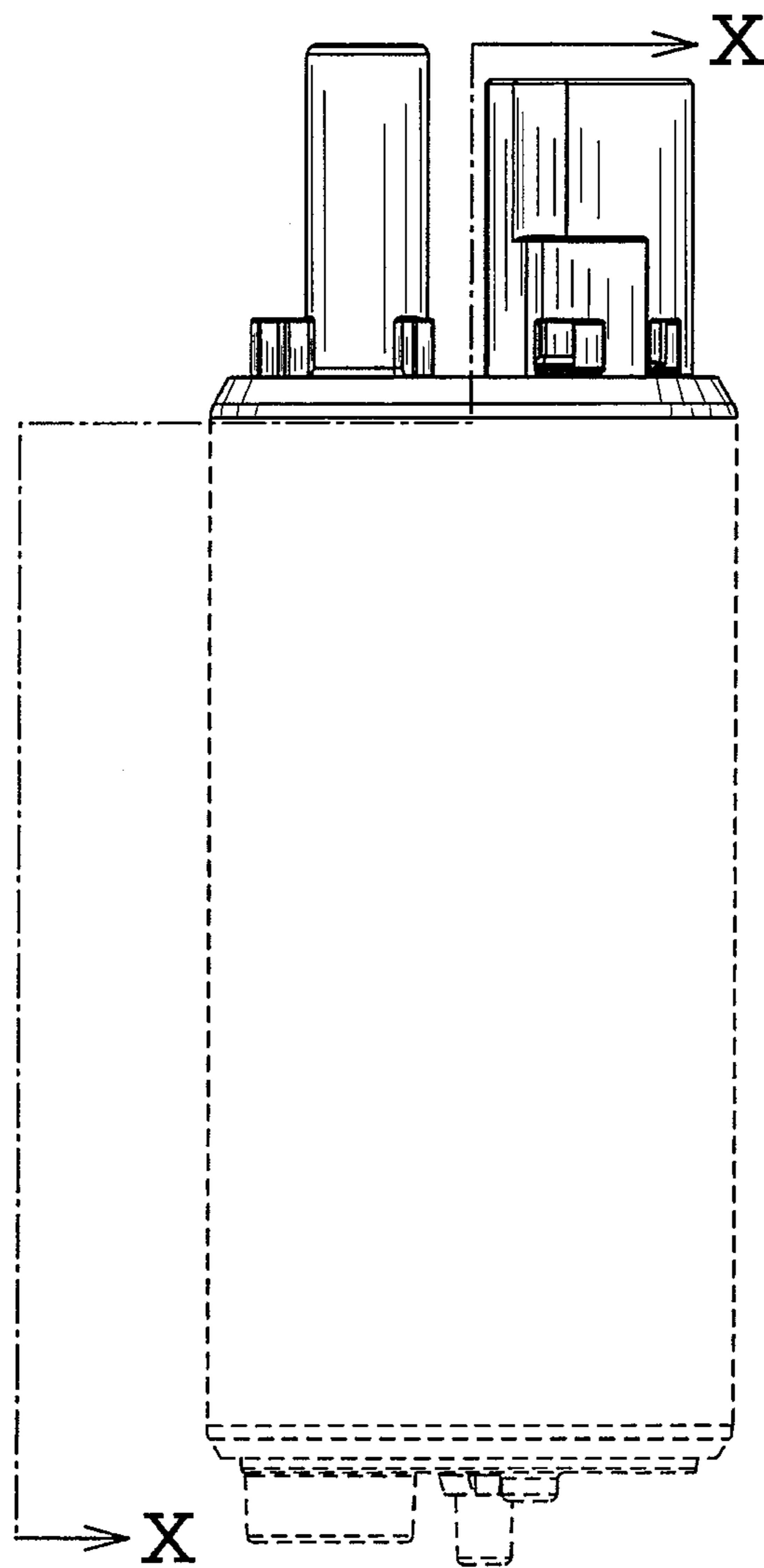

FIG. 10

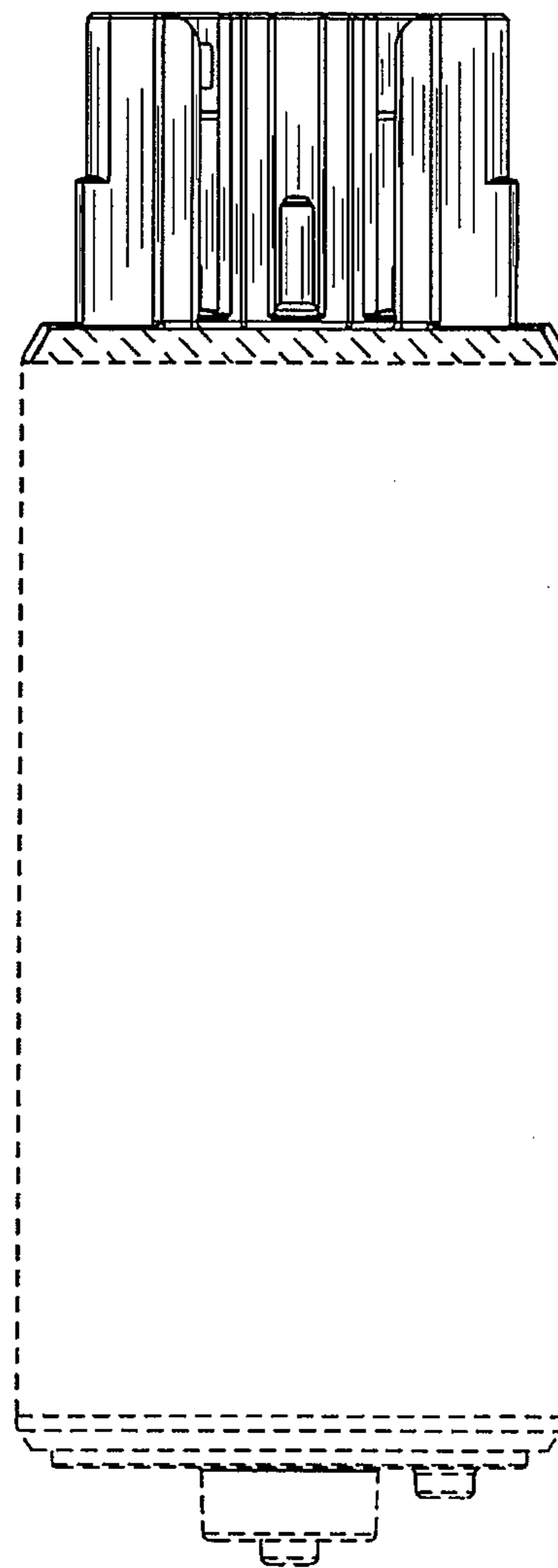

FIG. 11

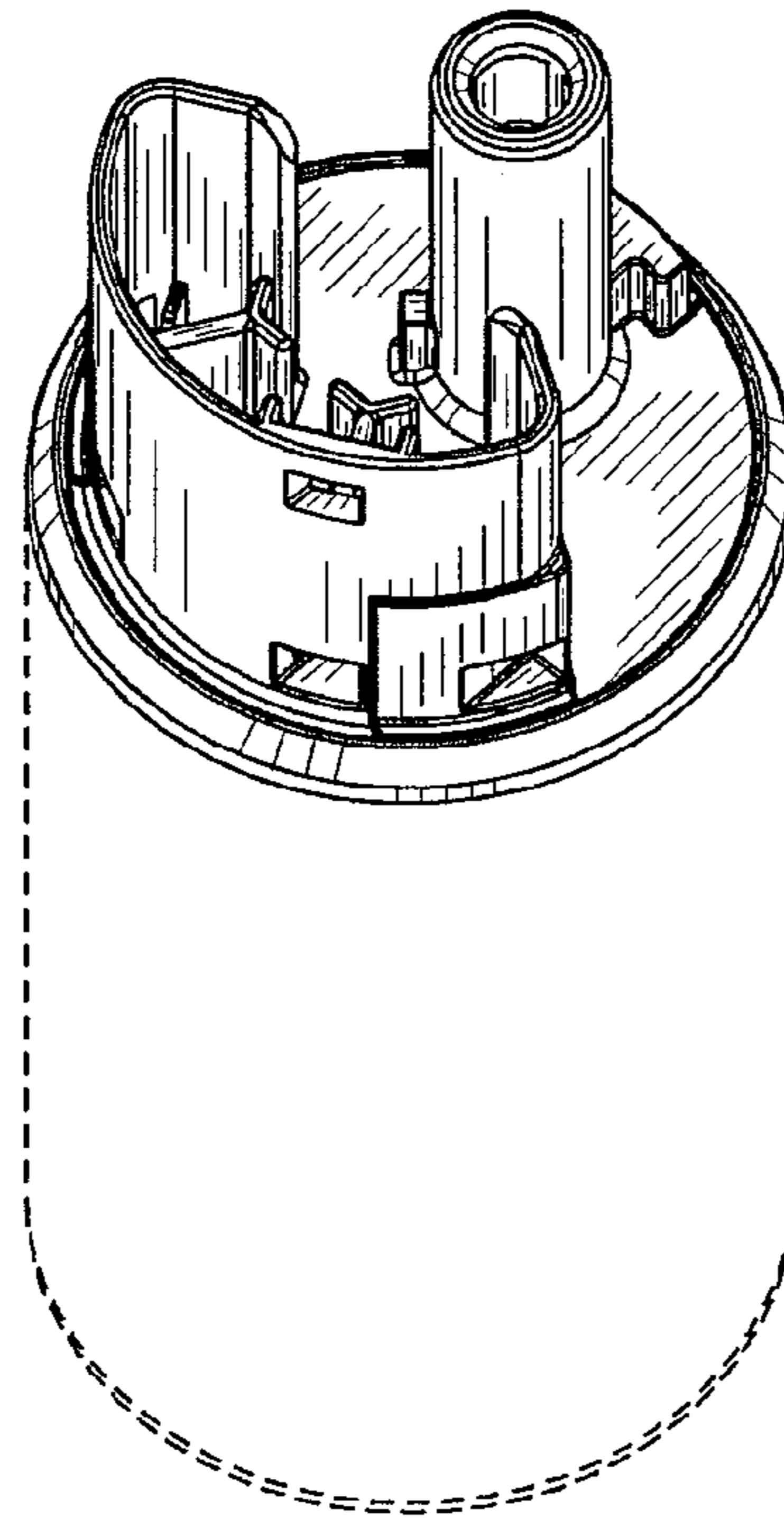

FIG. 12

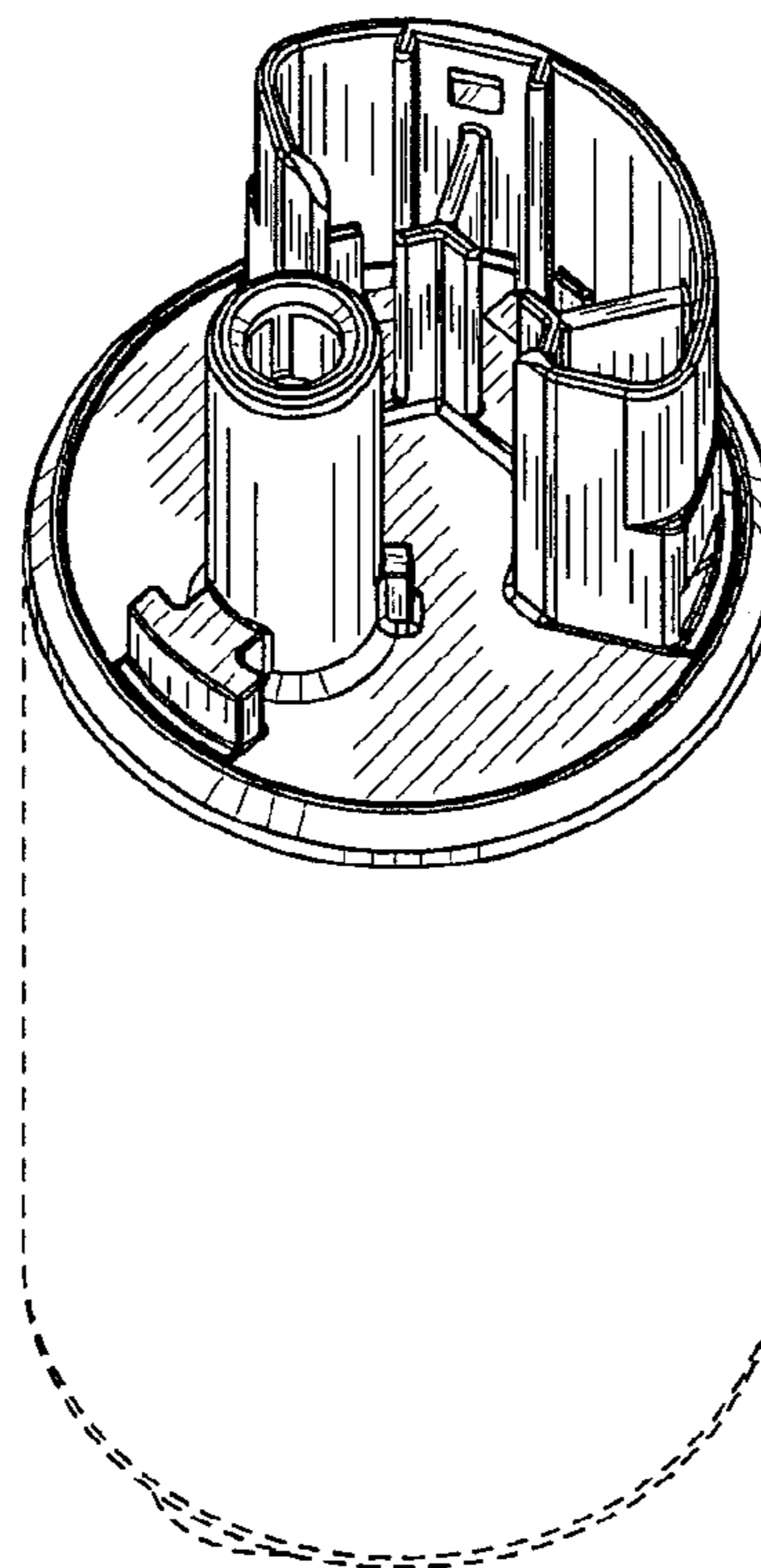

FIG. 13

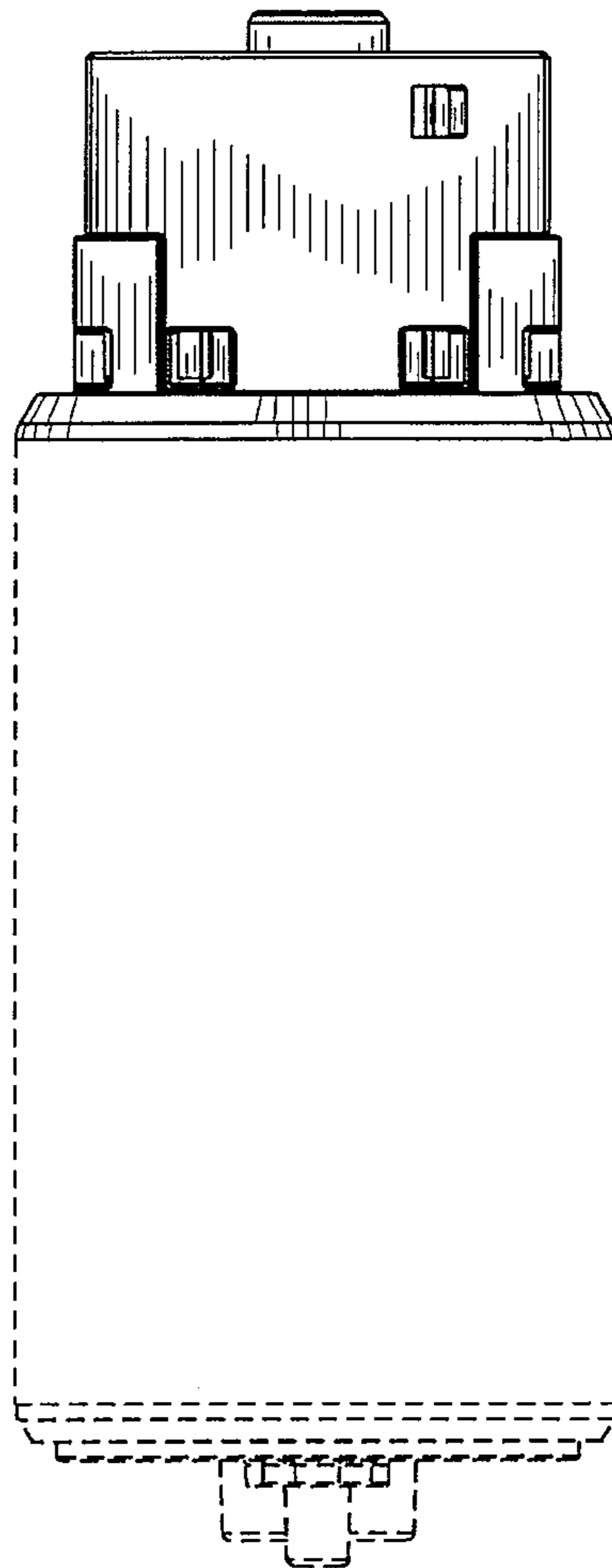

FIG. 14

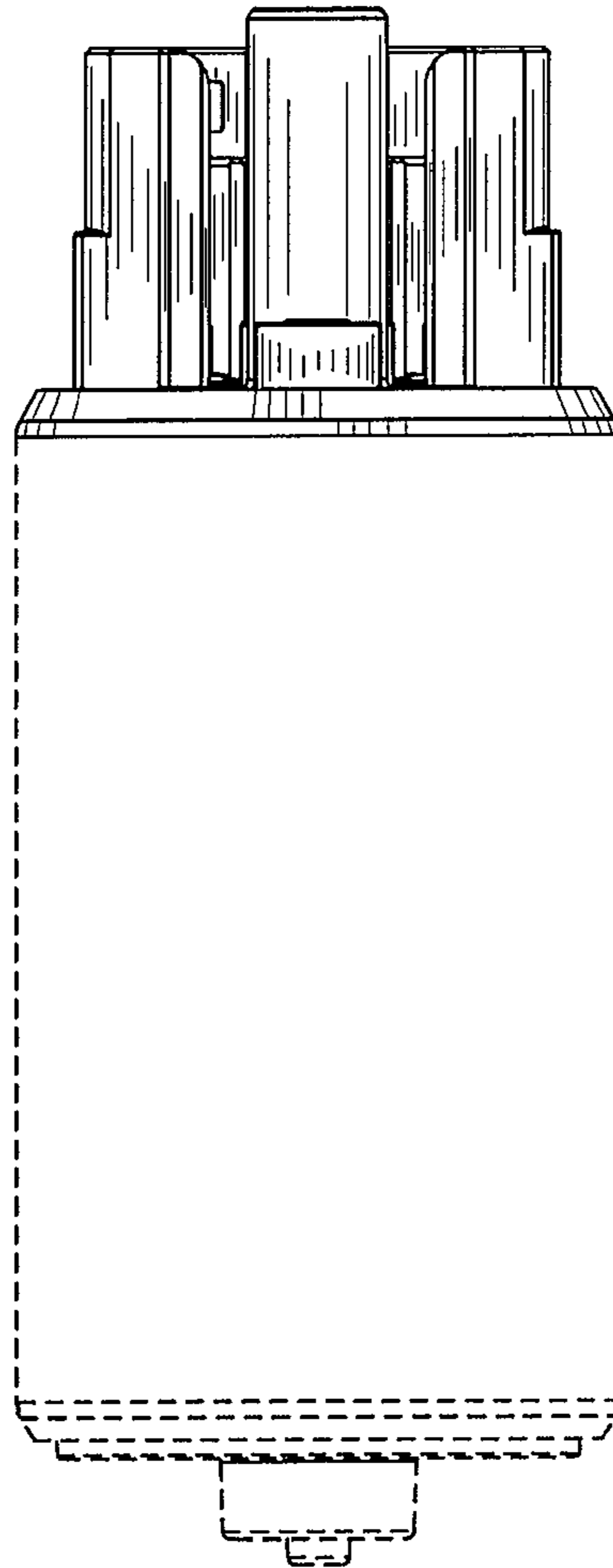
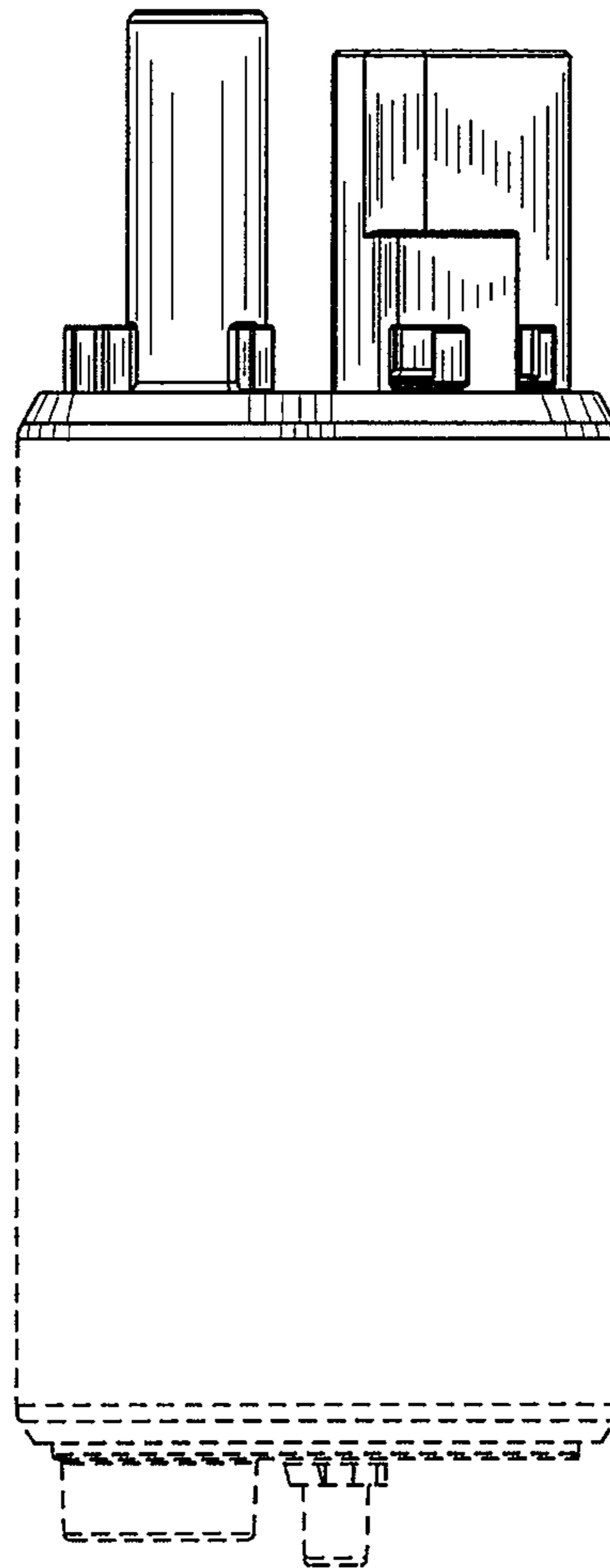
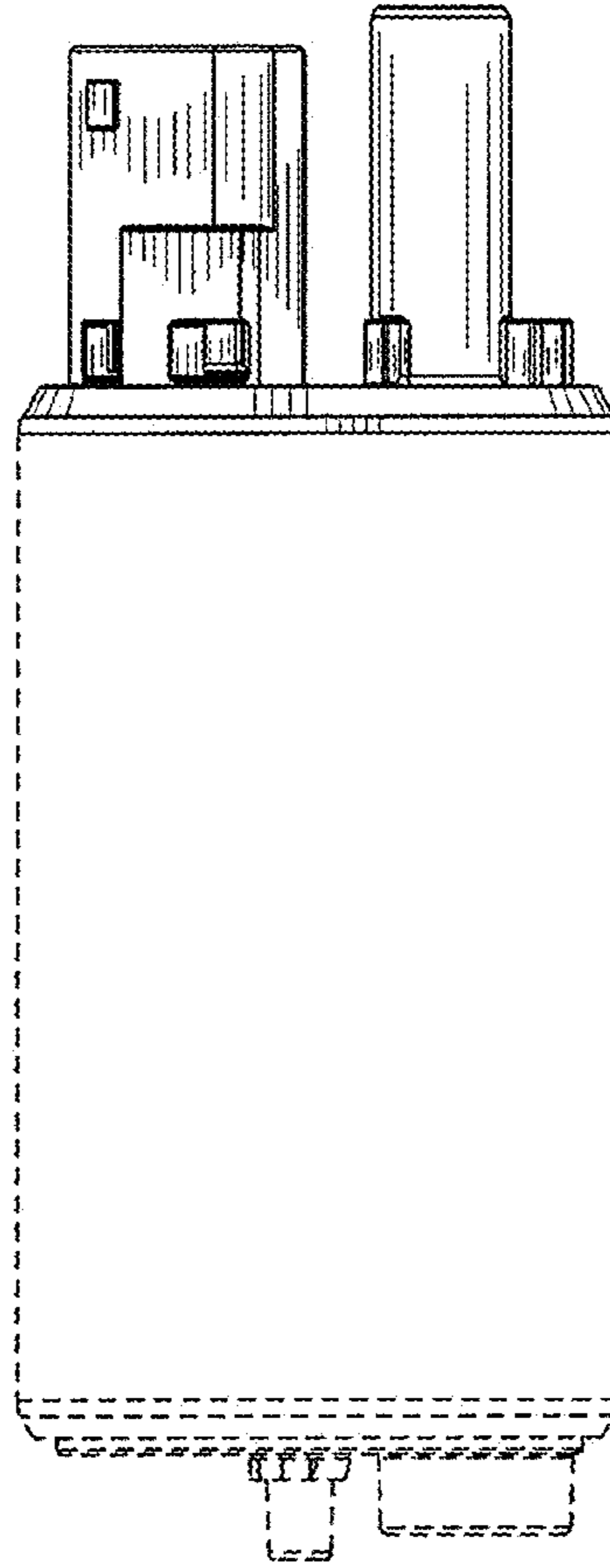

FIG. 15



**FIG. 16**



**FIG. 17**

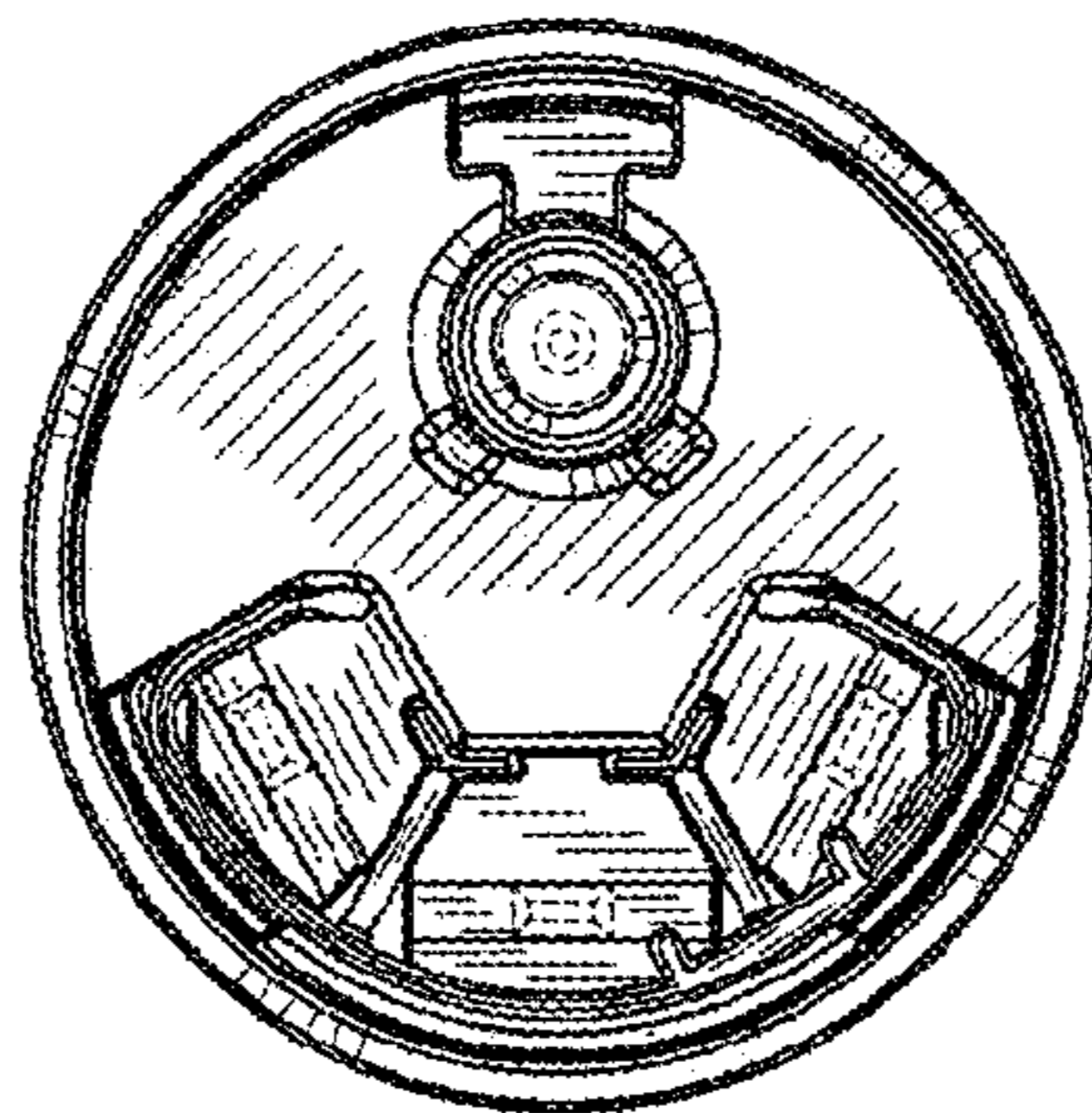

**FIG. 18**

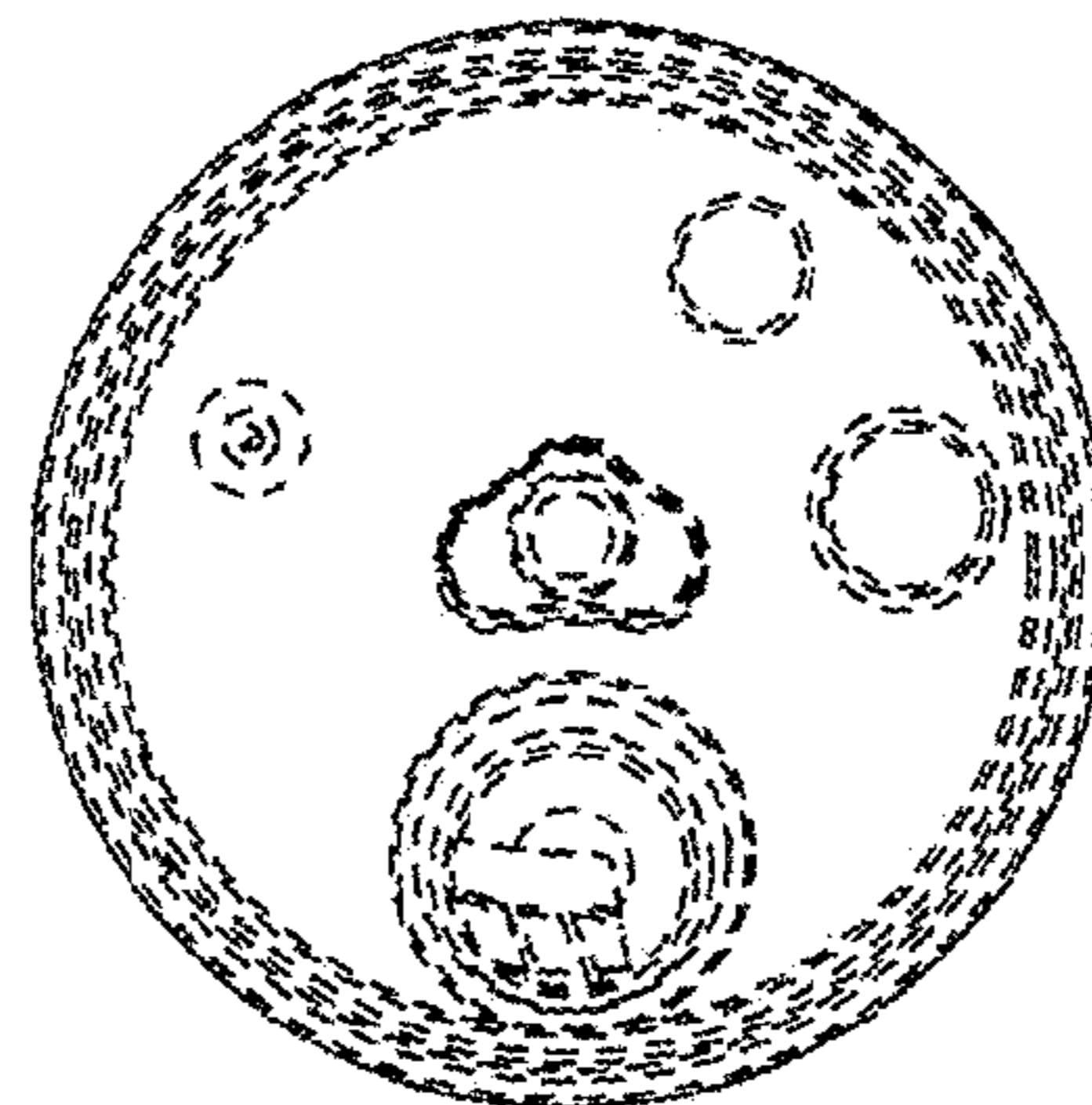

FIG. 19

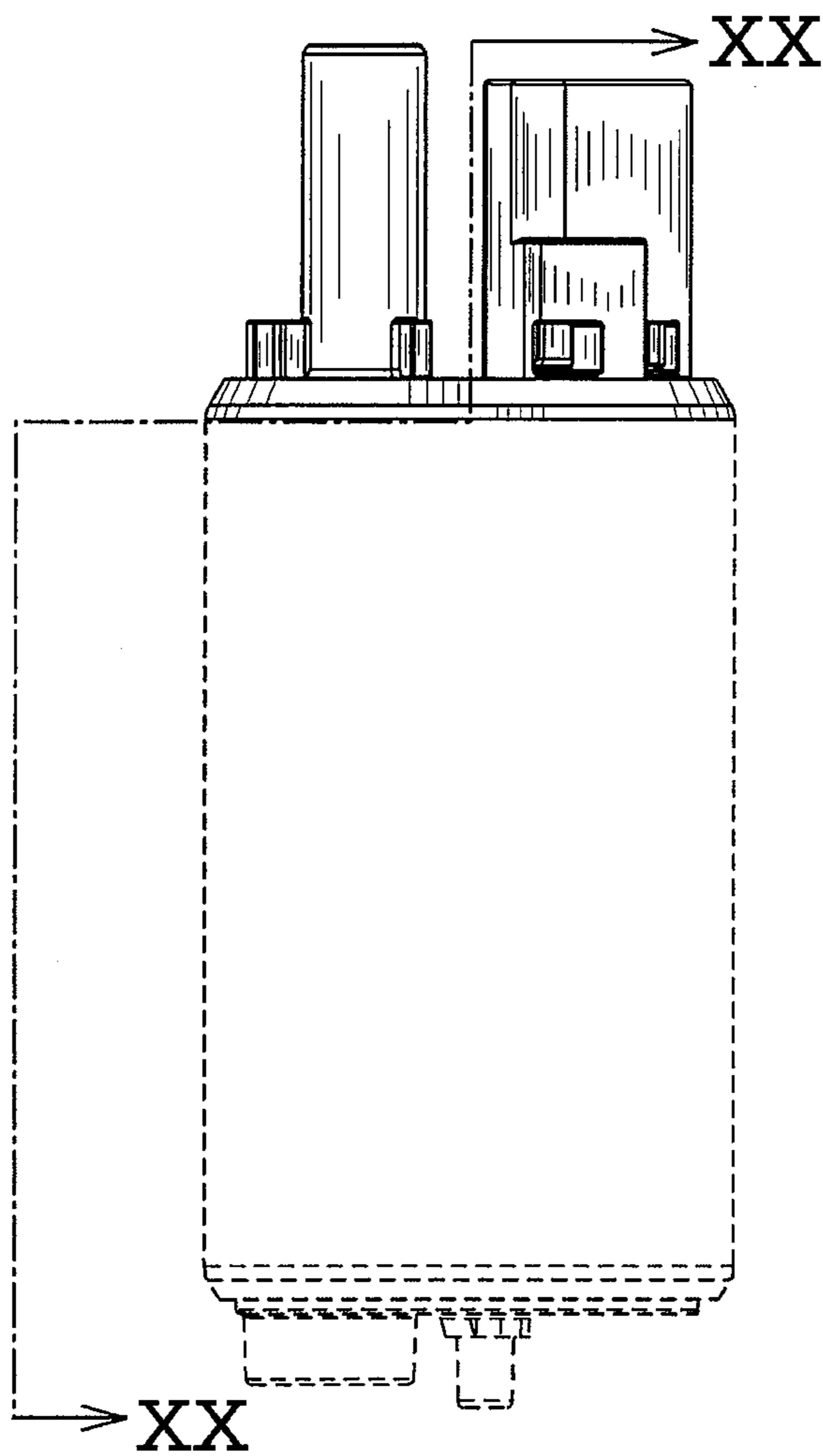



FIG. 20

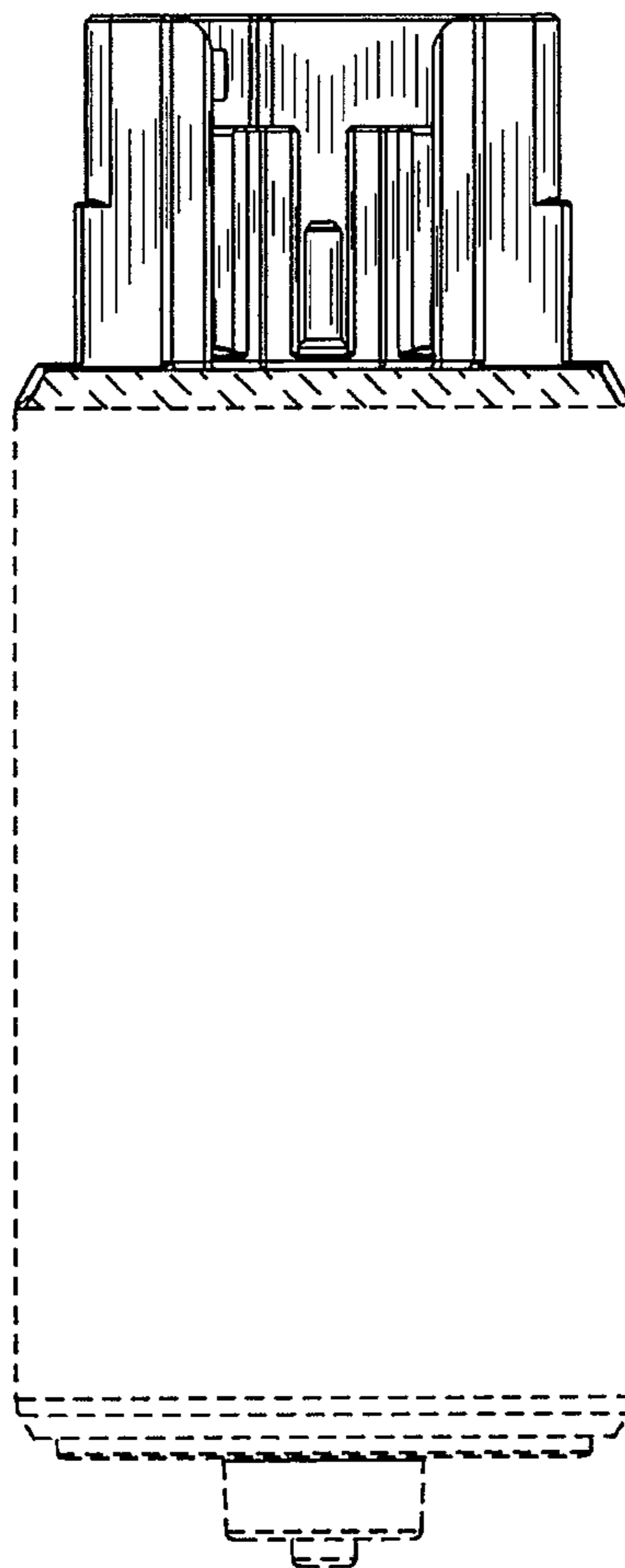

FIG. 21

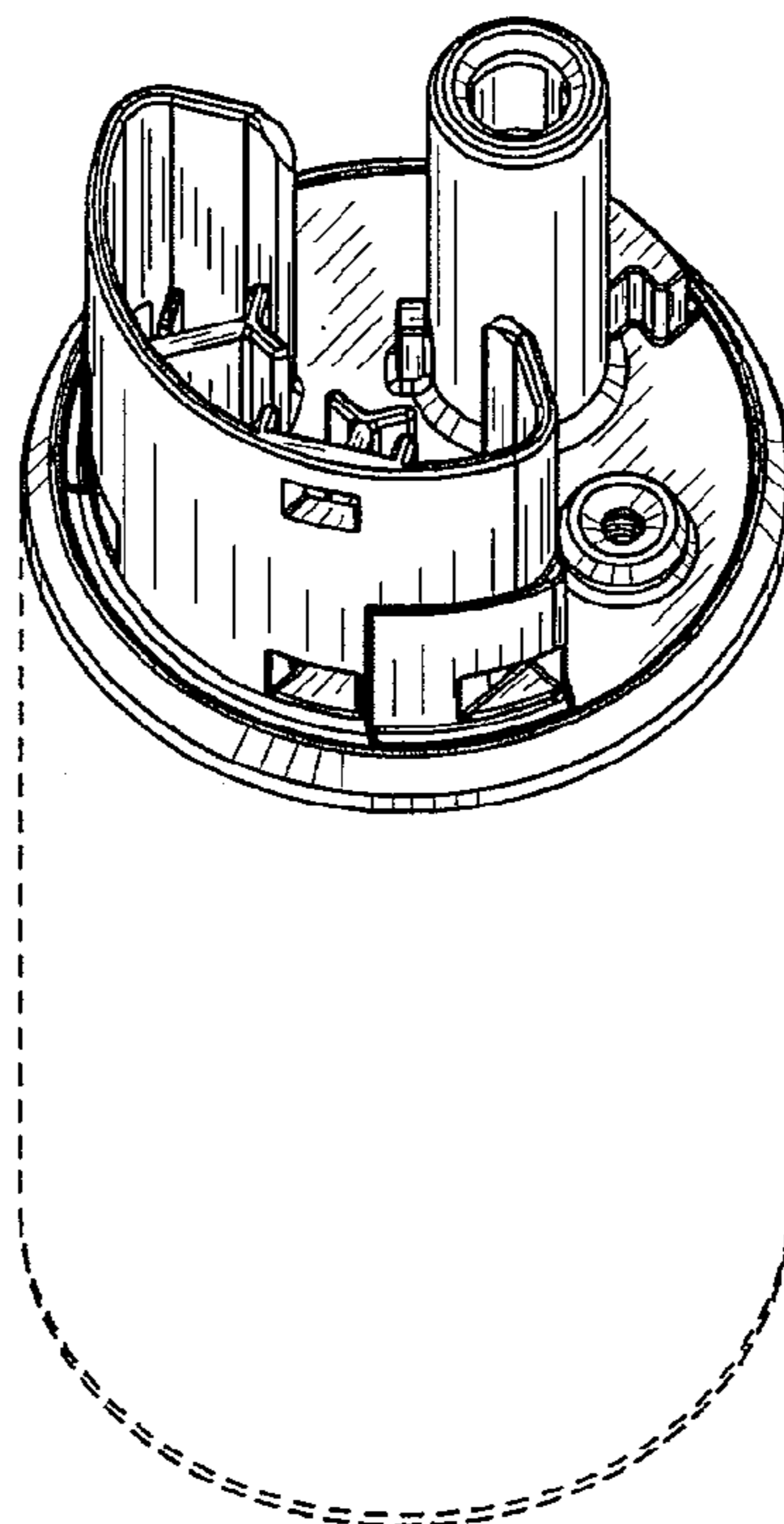

FIG. 22

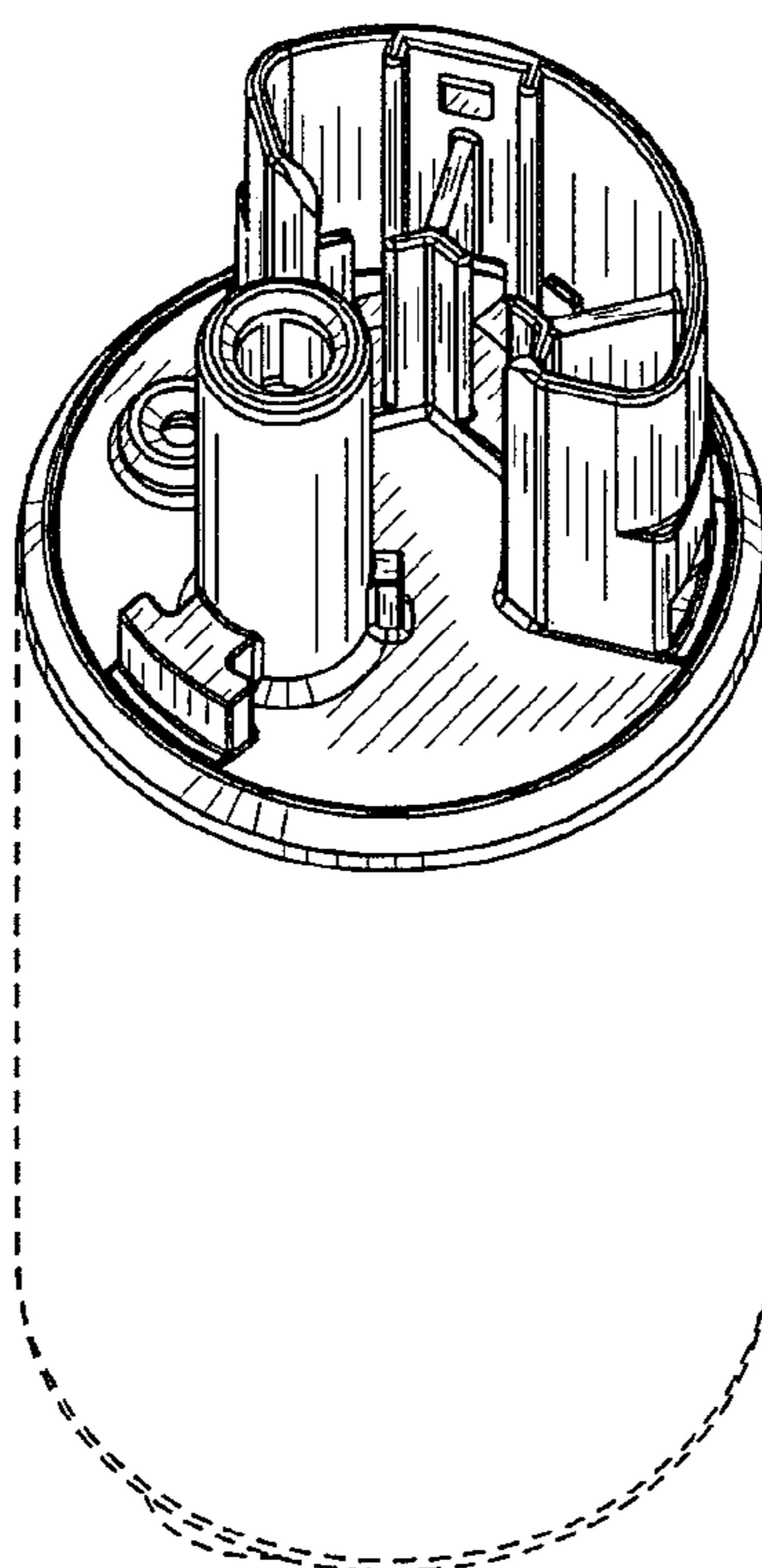

FIG. 23

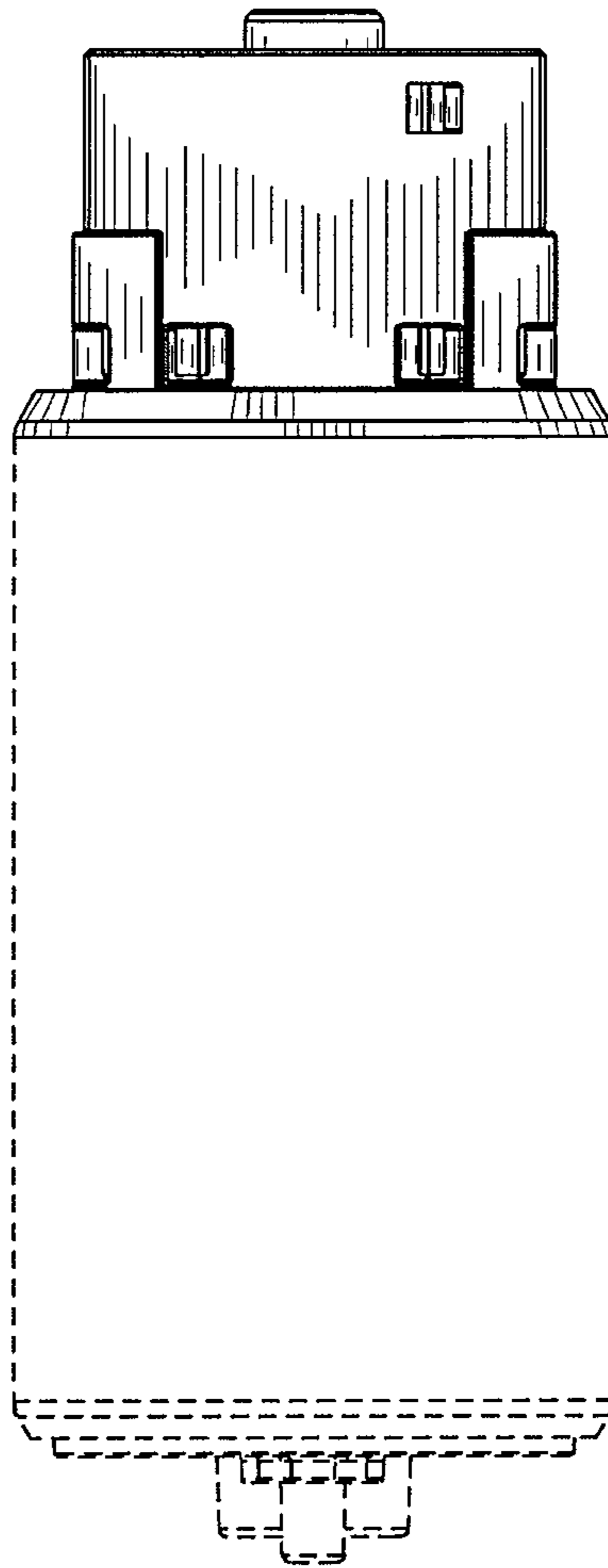

FIG. 24

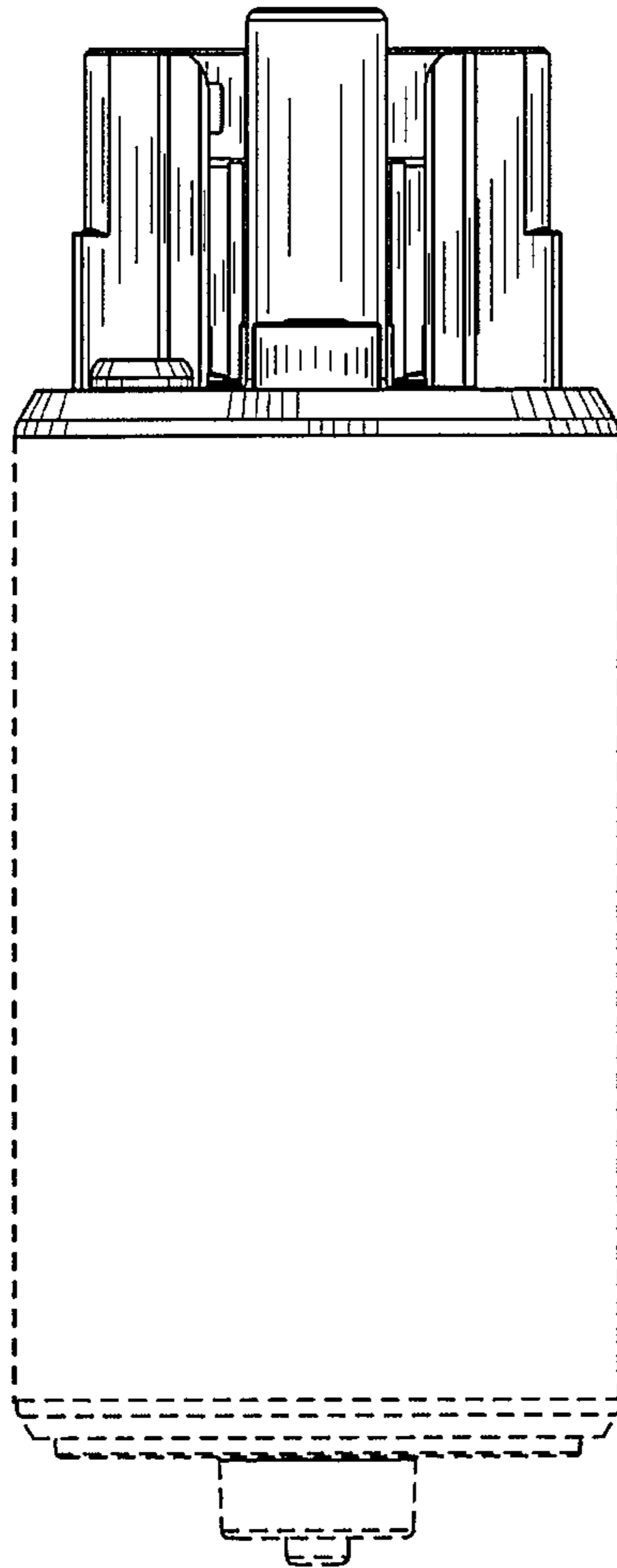
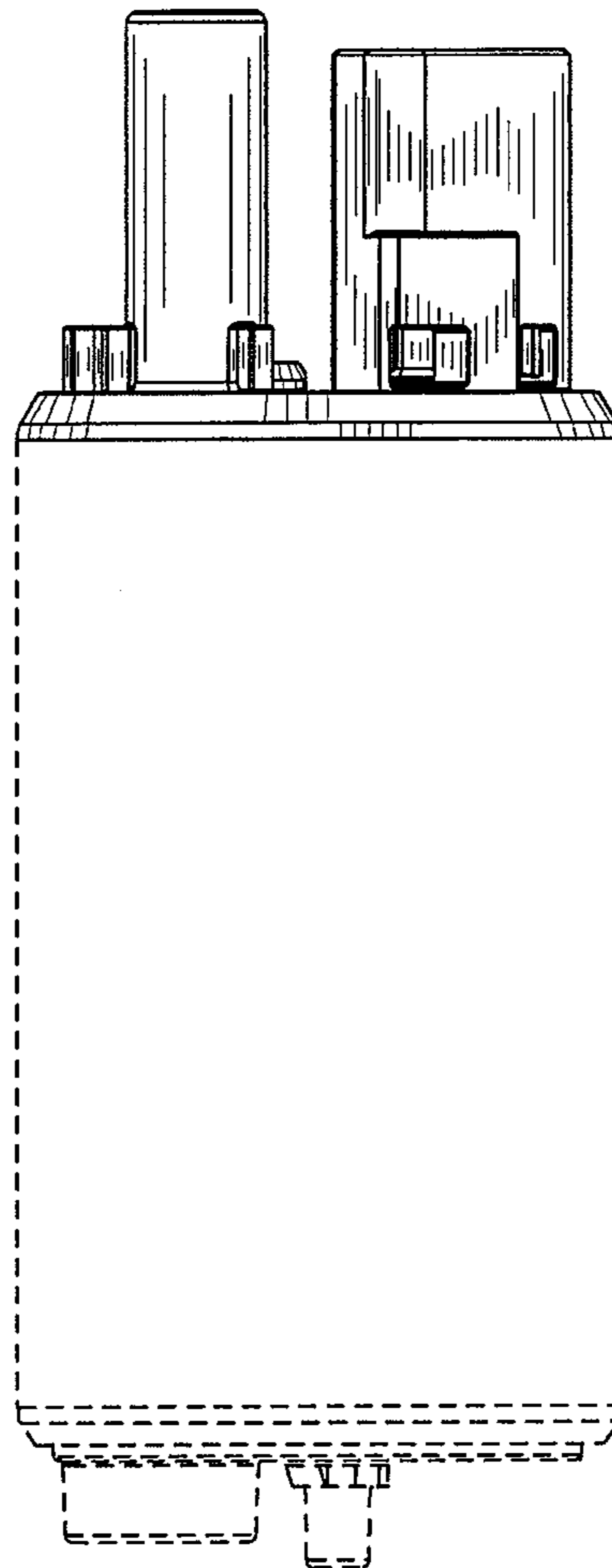
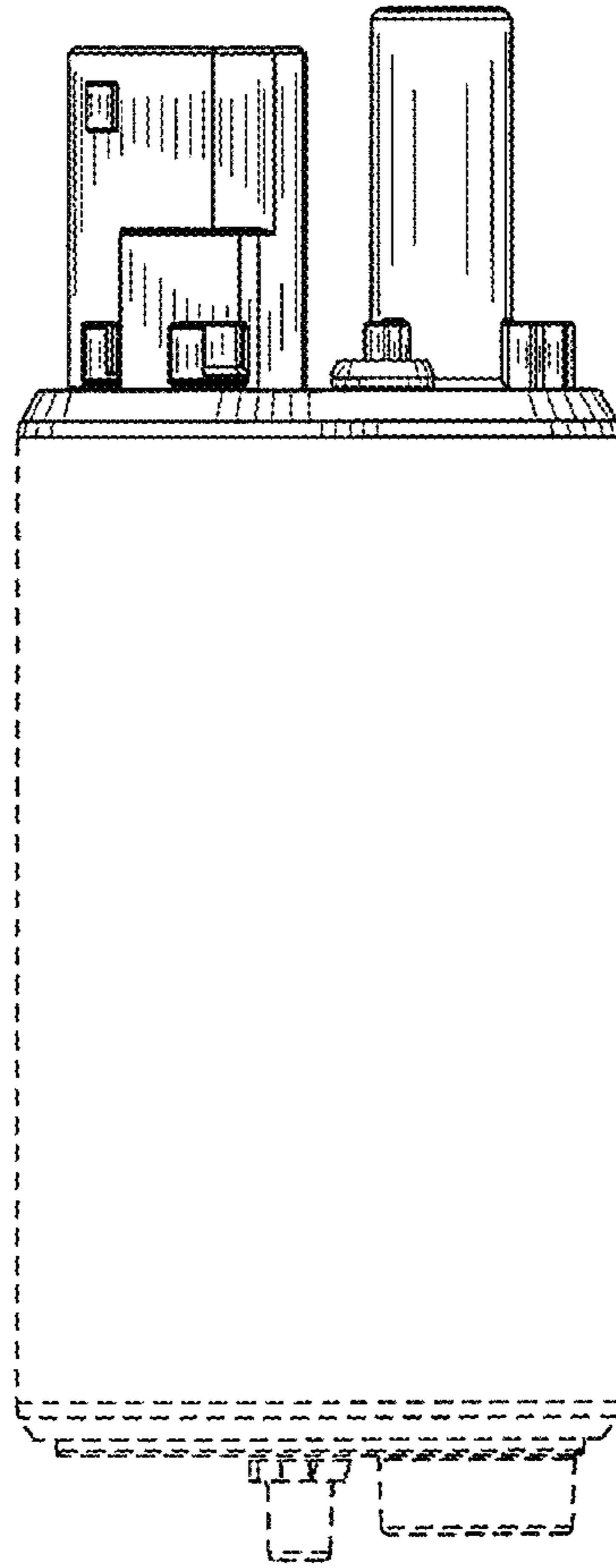

FIG. 25



**FIG. 26**



**FIG. 27**

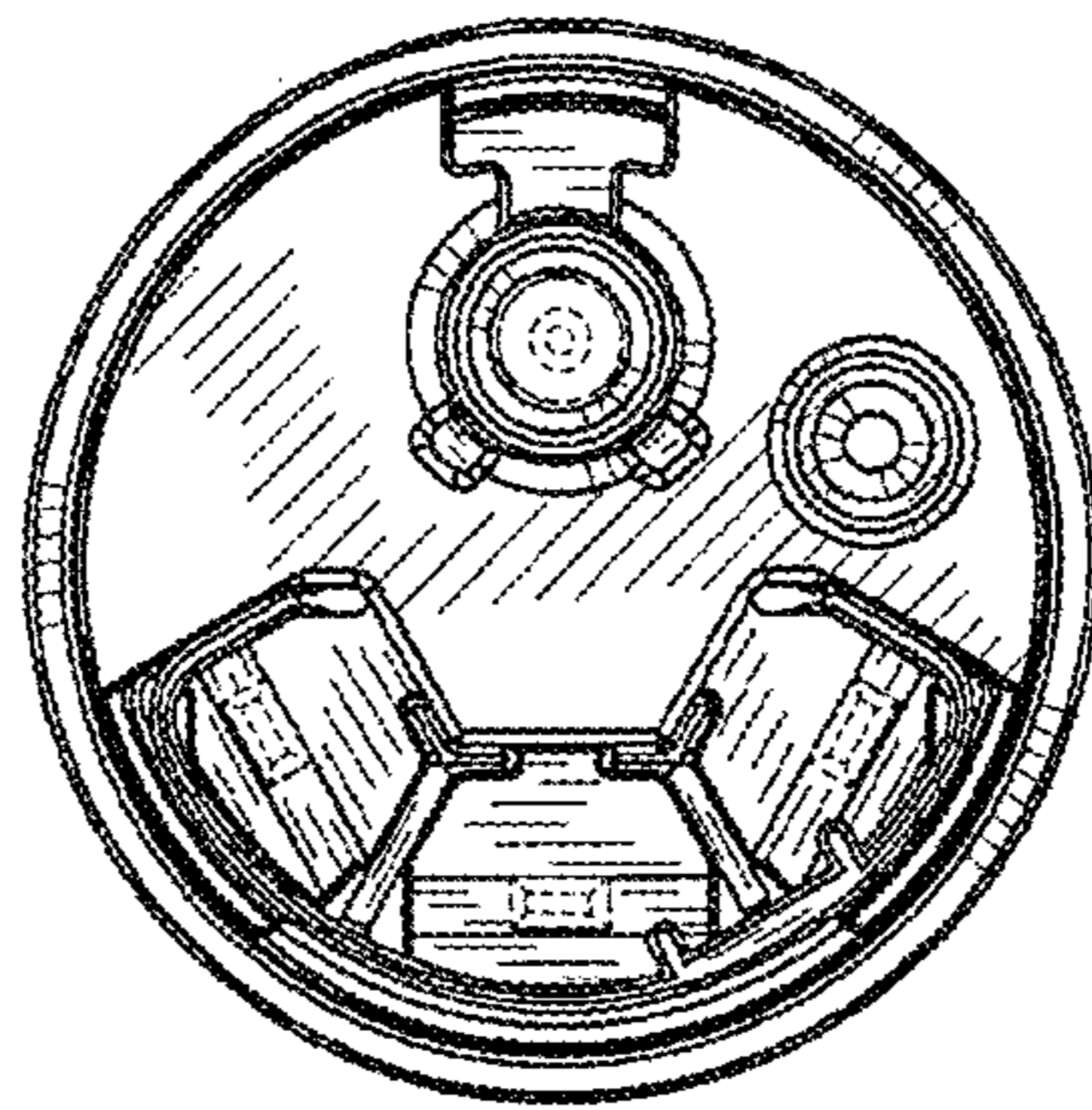

**FIG. 28**

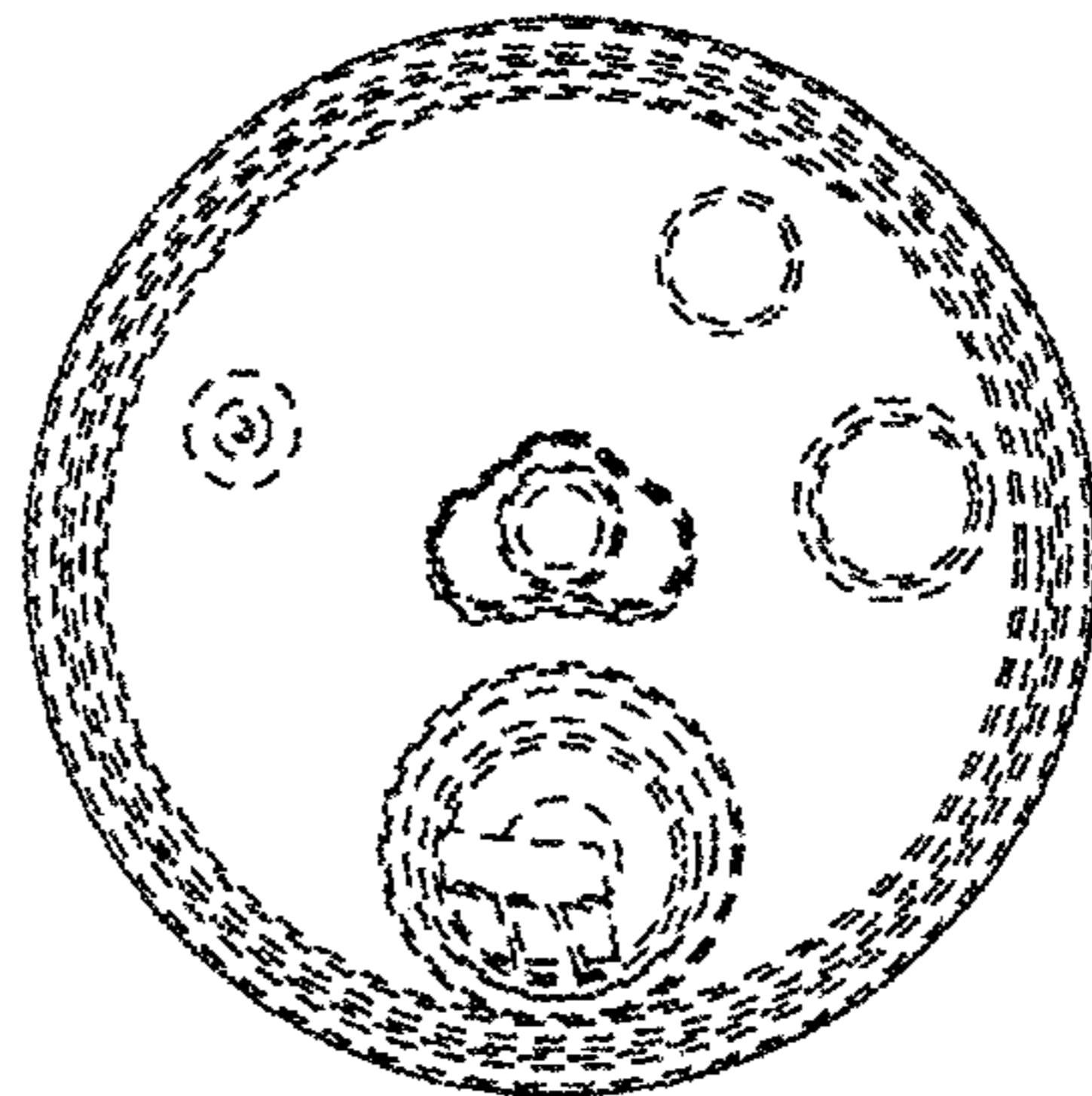

FIG. 29

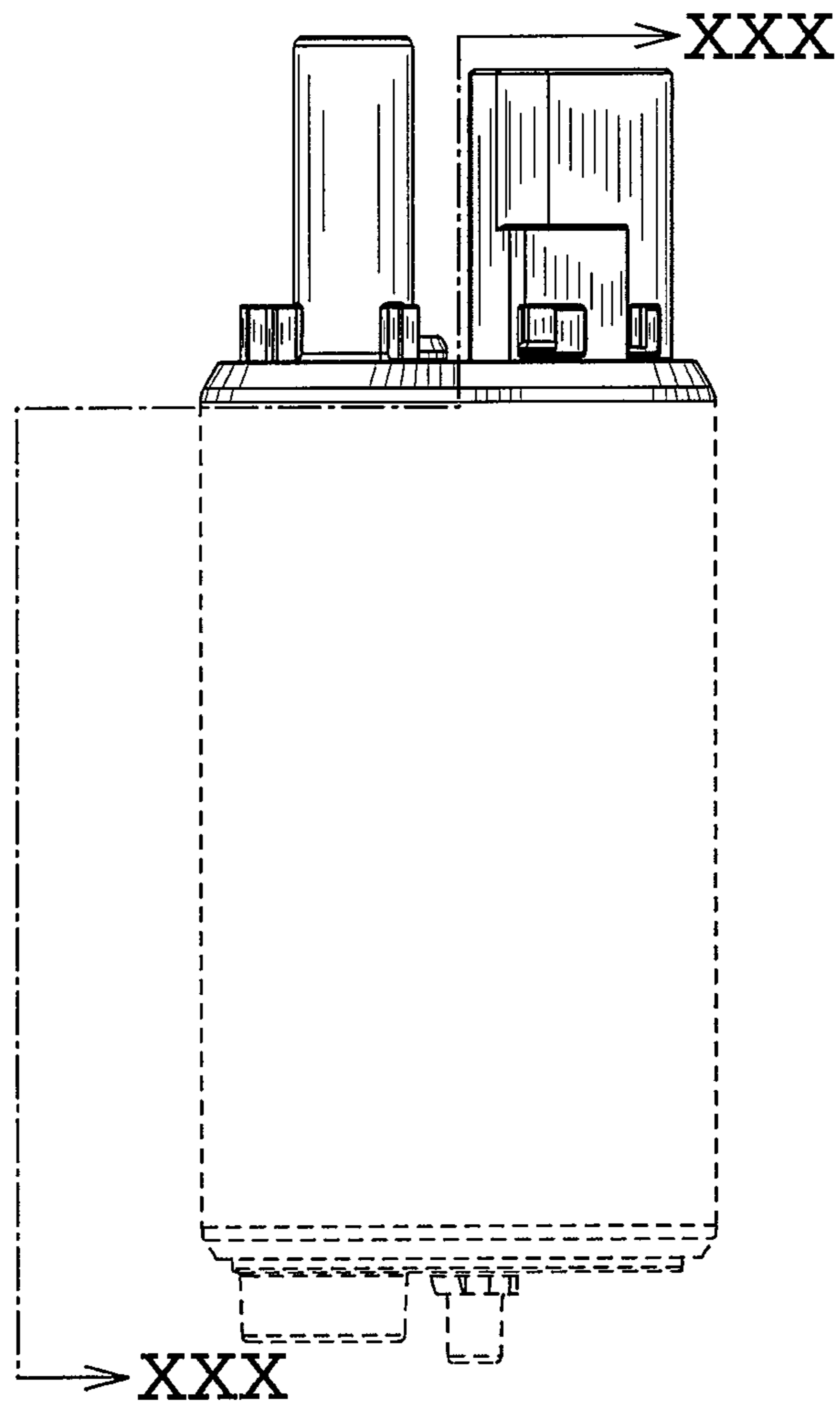
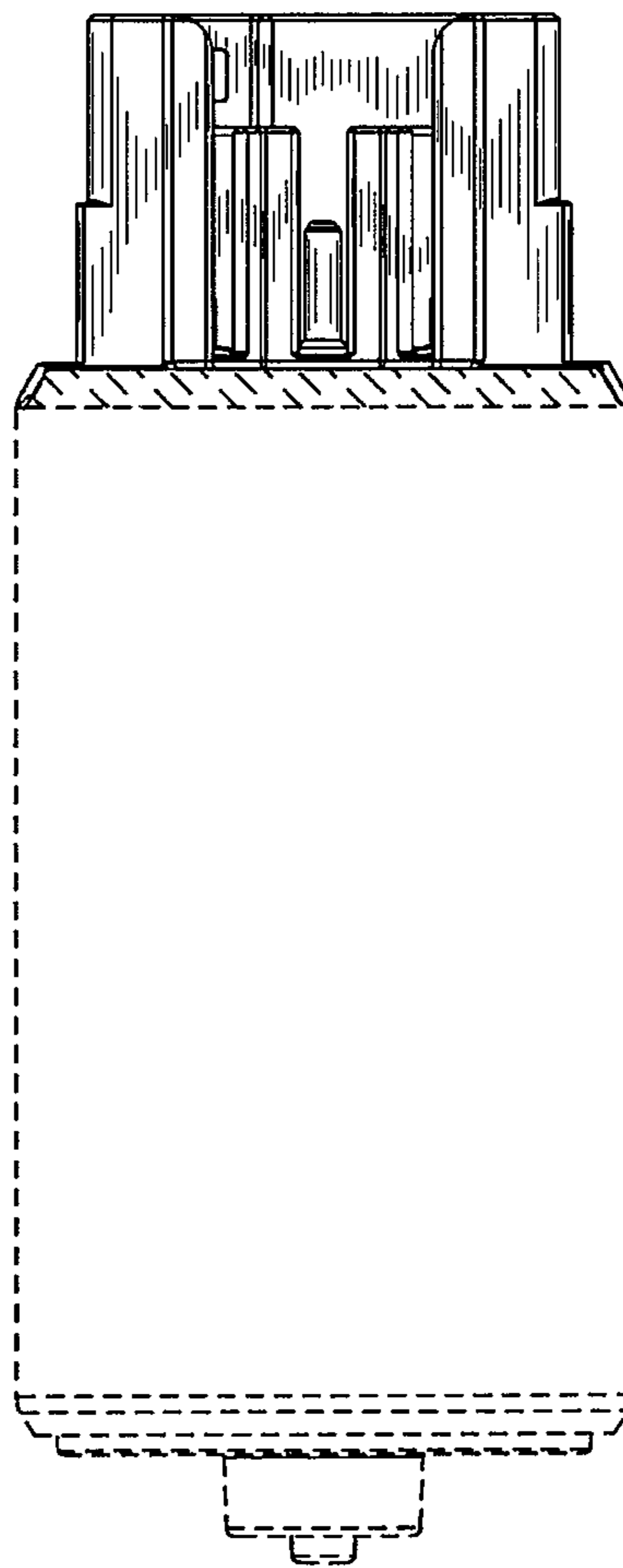
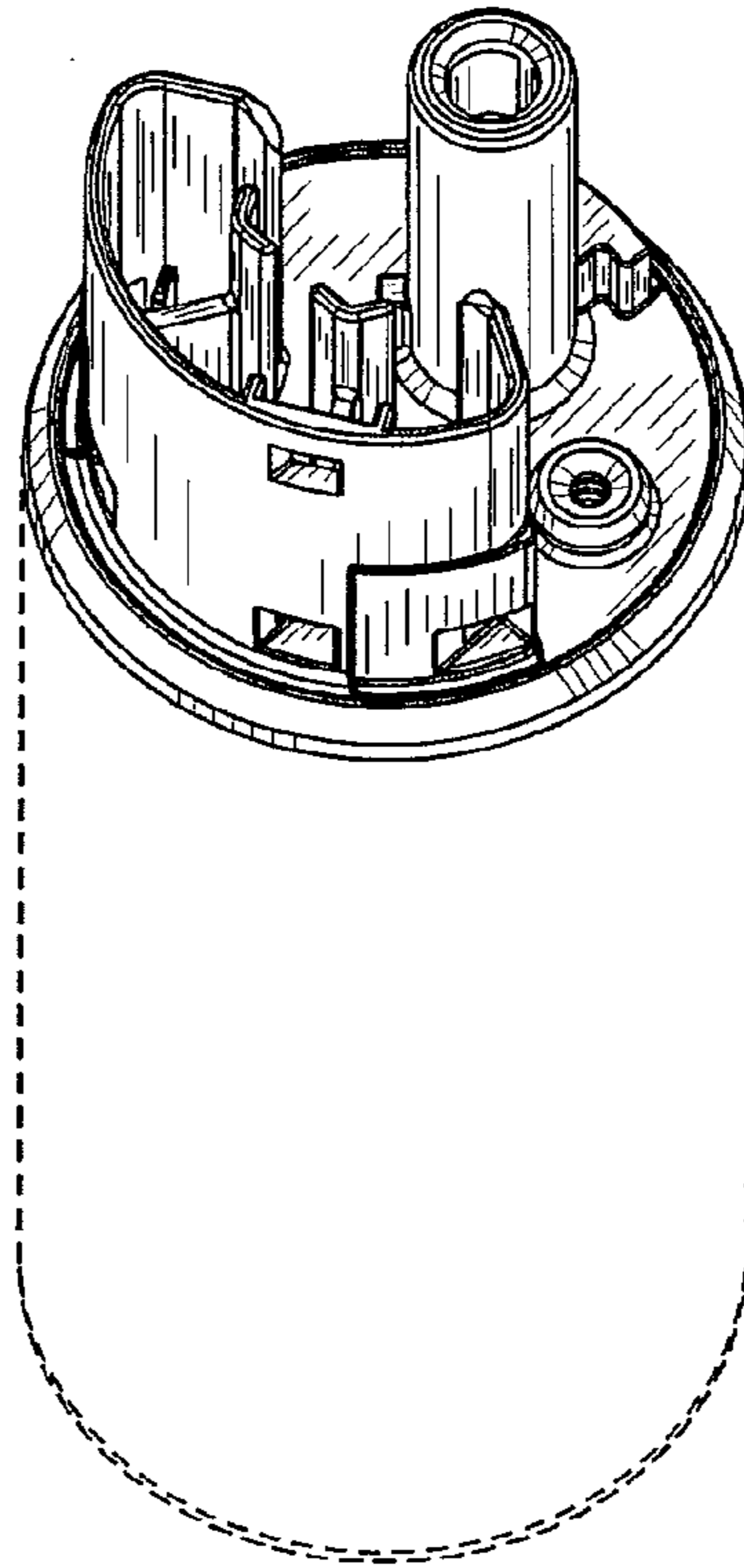

FIG. 30

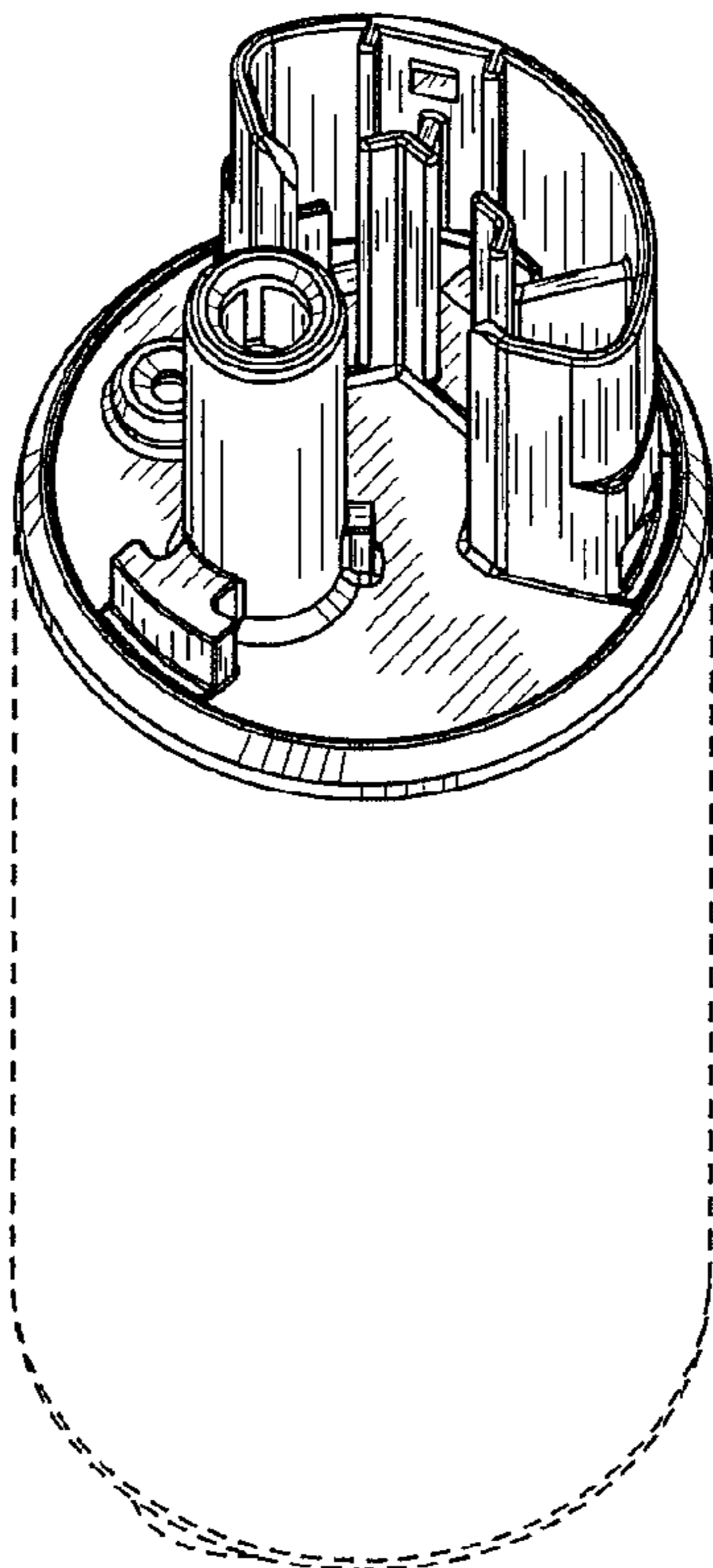



**FIG. 31**



**FIG. 32**



**FIG. 33**

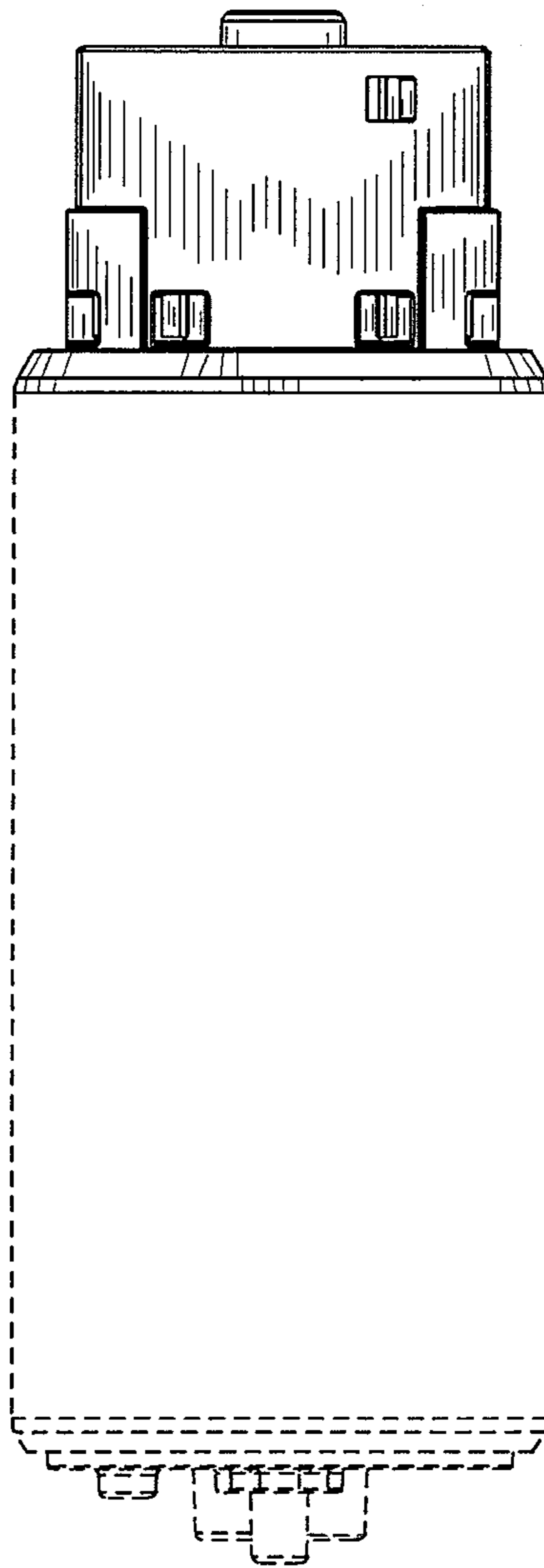

FIG. 34

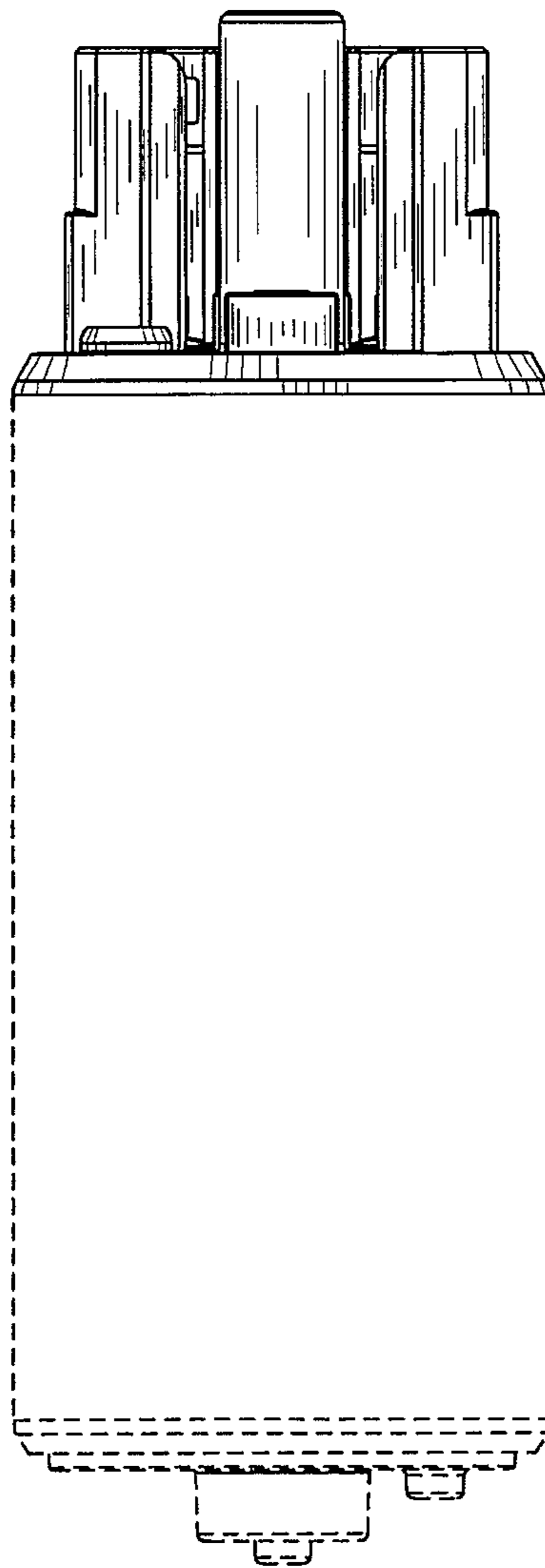

FIG. 35

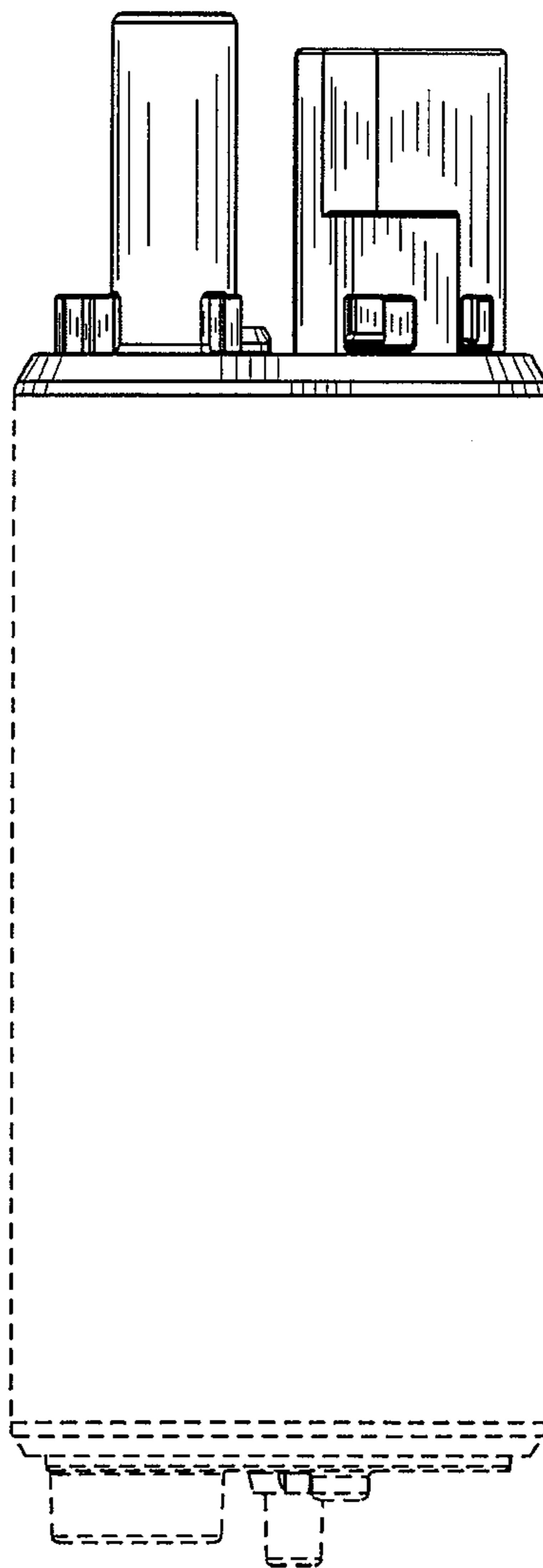
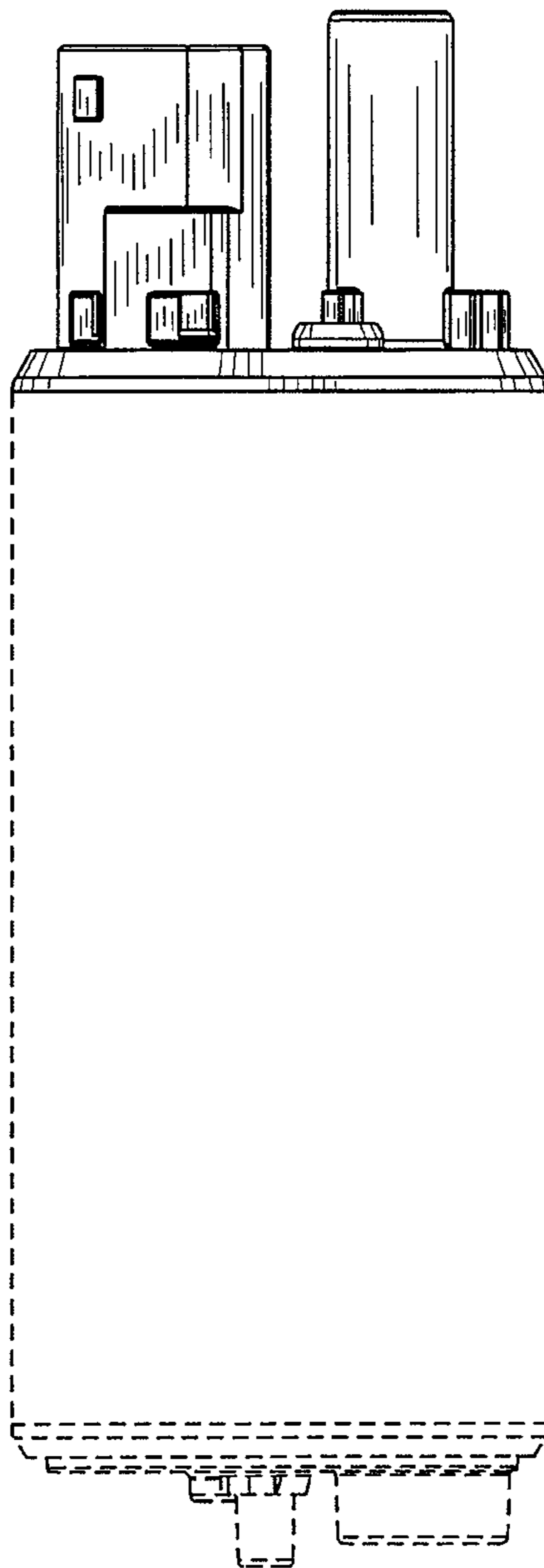
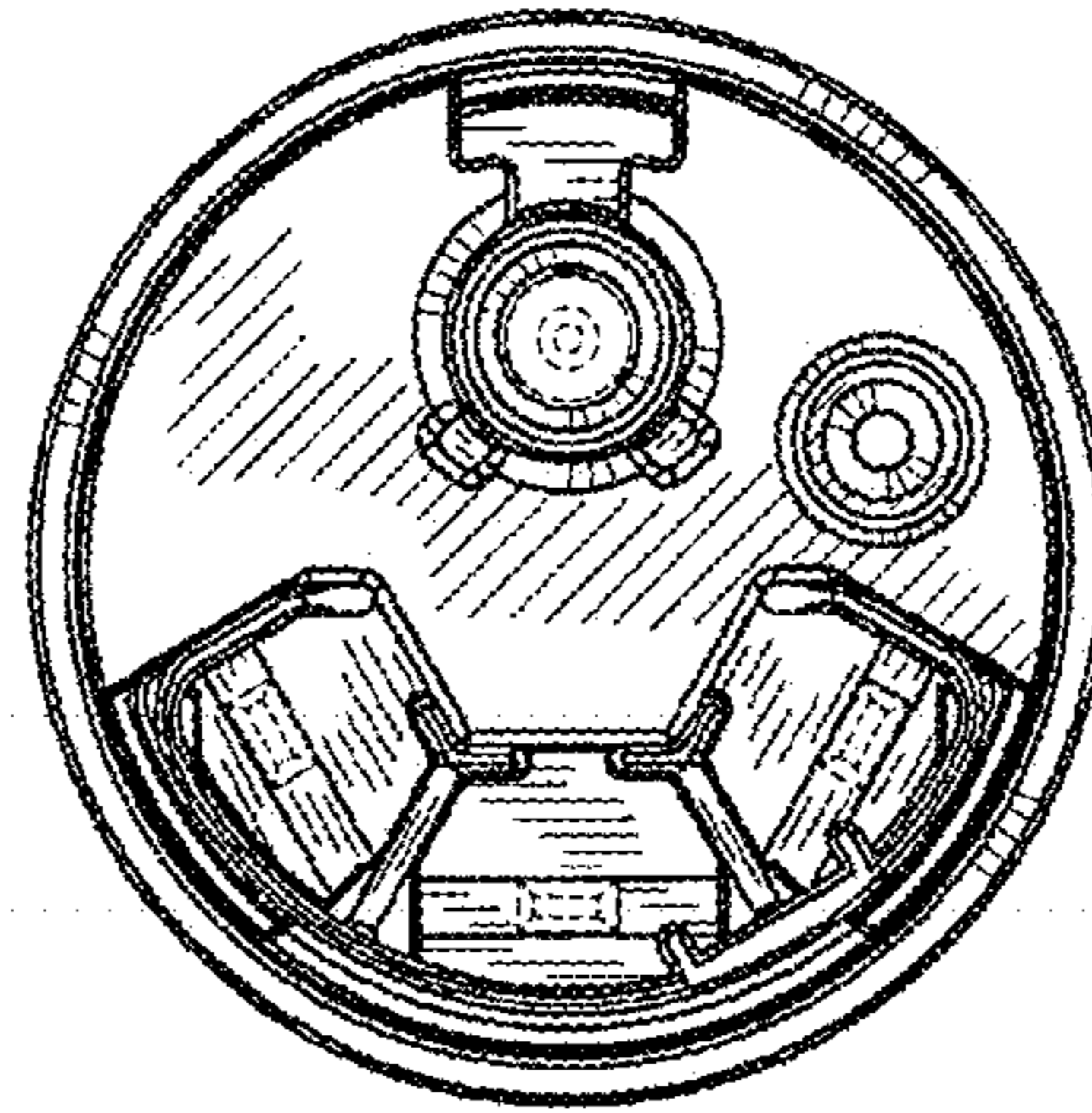

FIG. 36



**FIG. 37**



**FIG. 38**

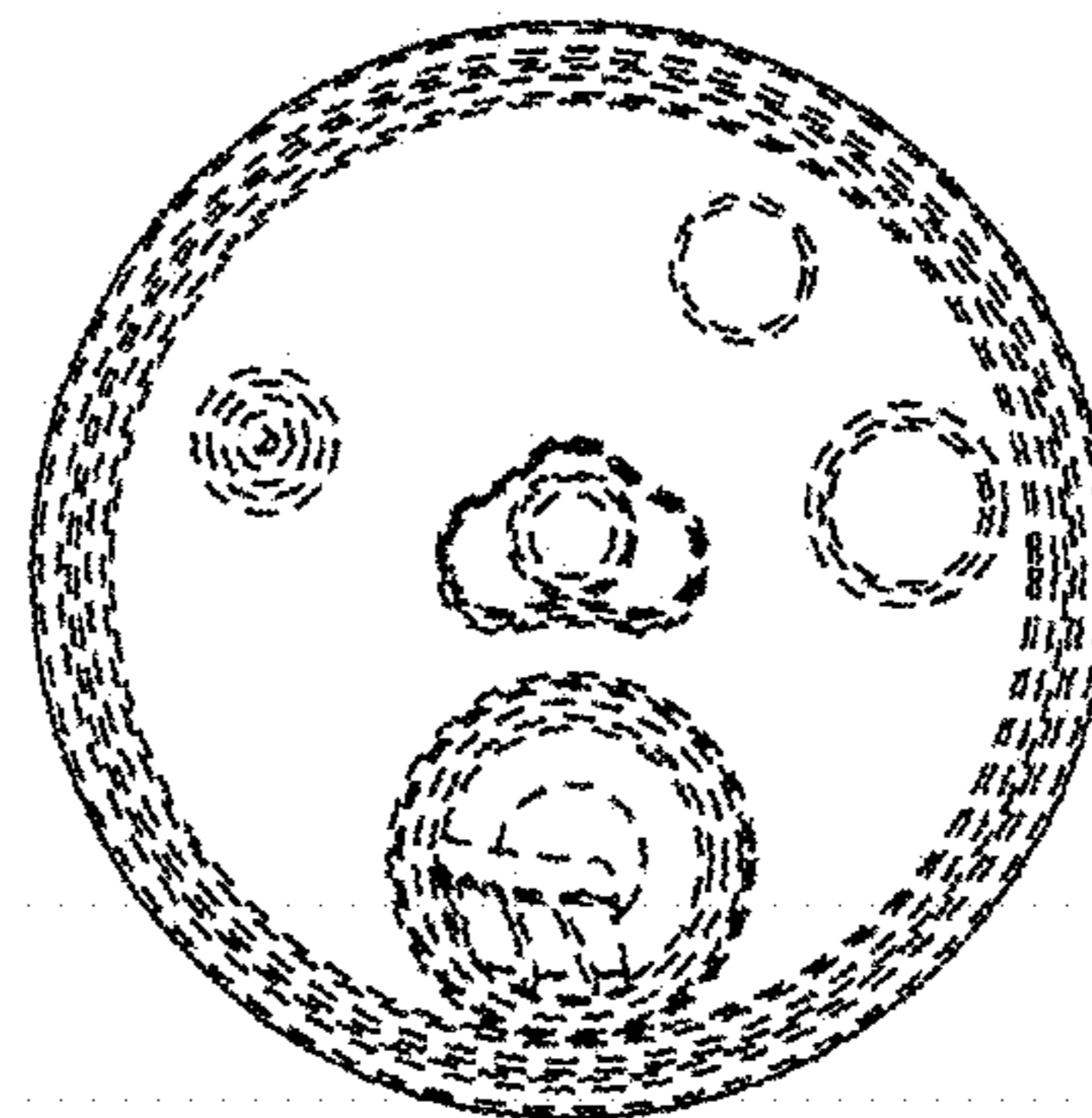

FIG. 39

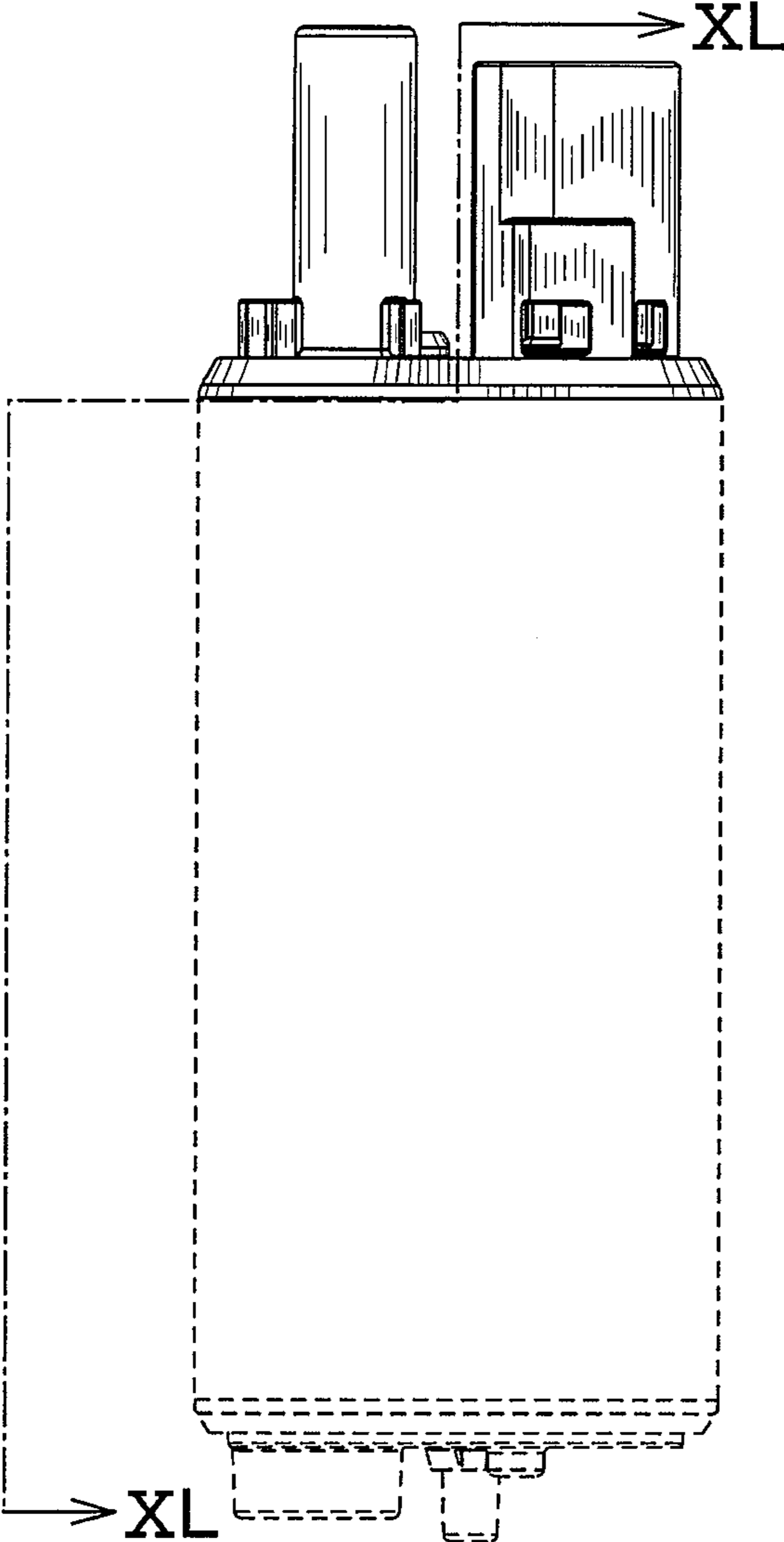
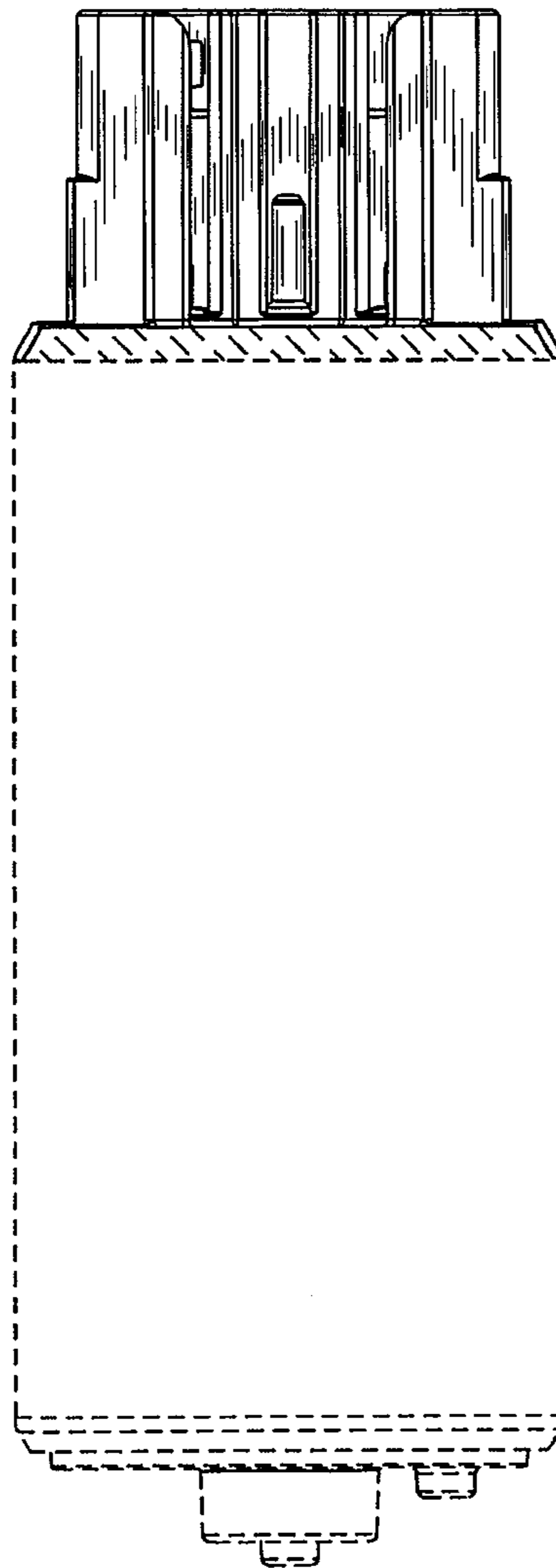
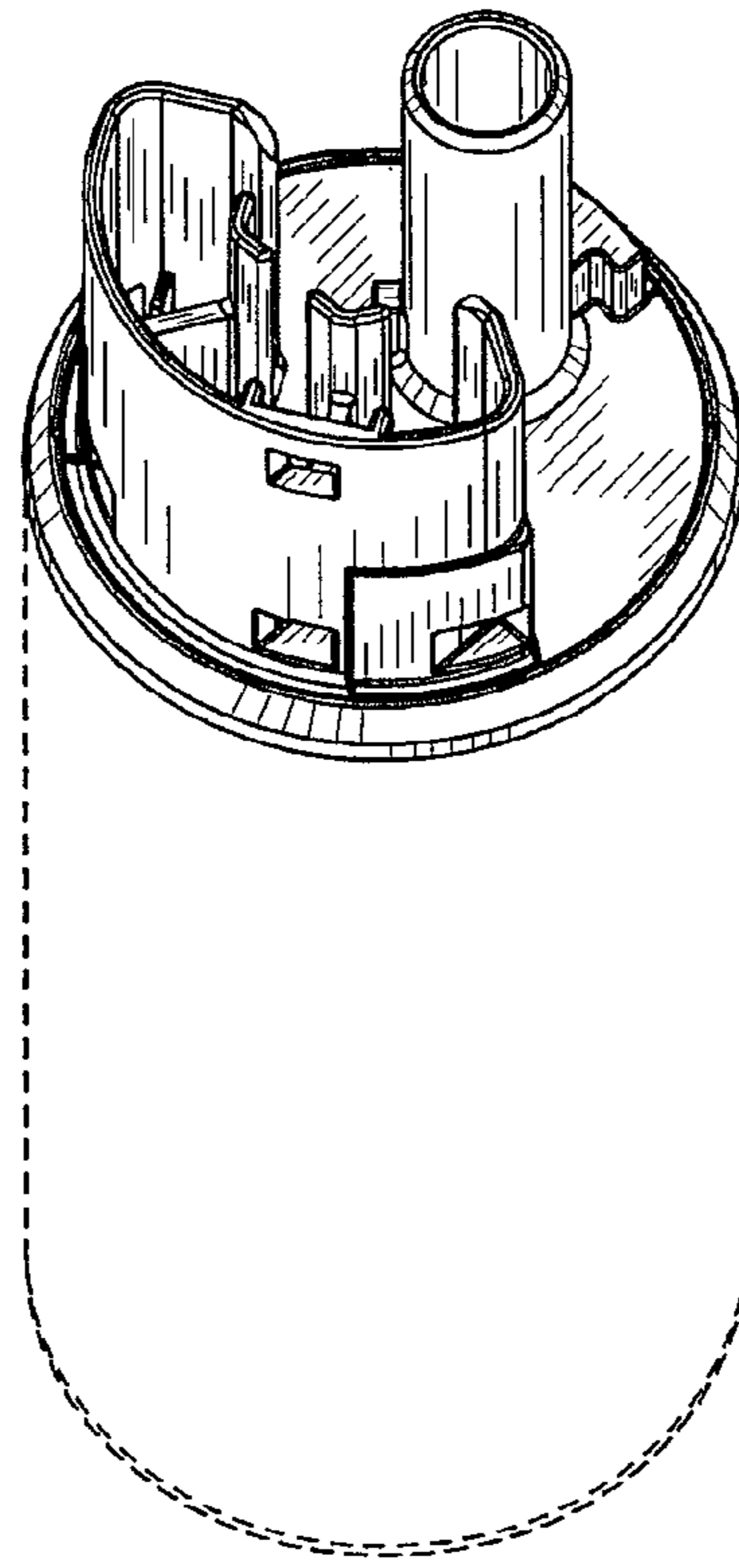

FIG. 40





**FIG. 41**



**FIG. 42**

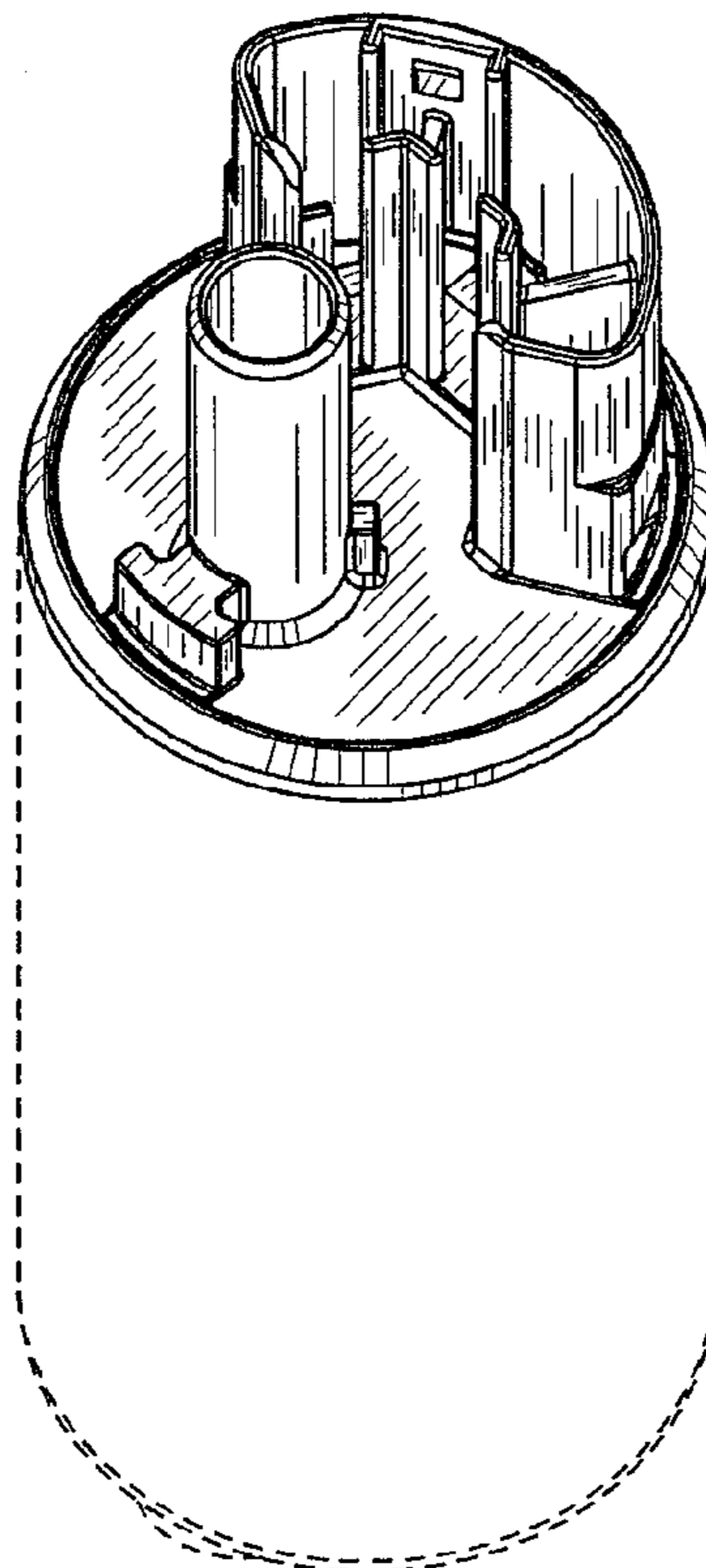

FIG. 43

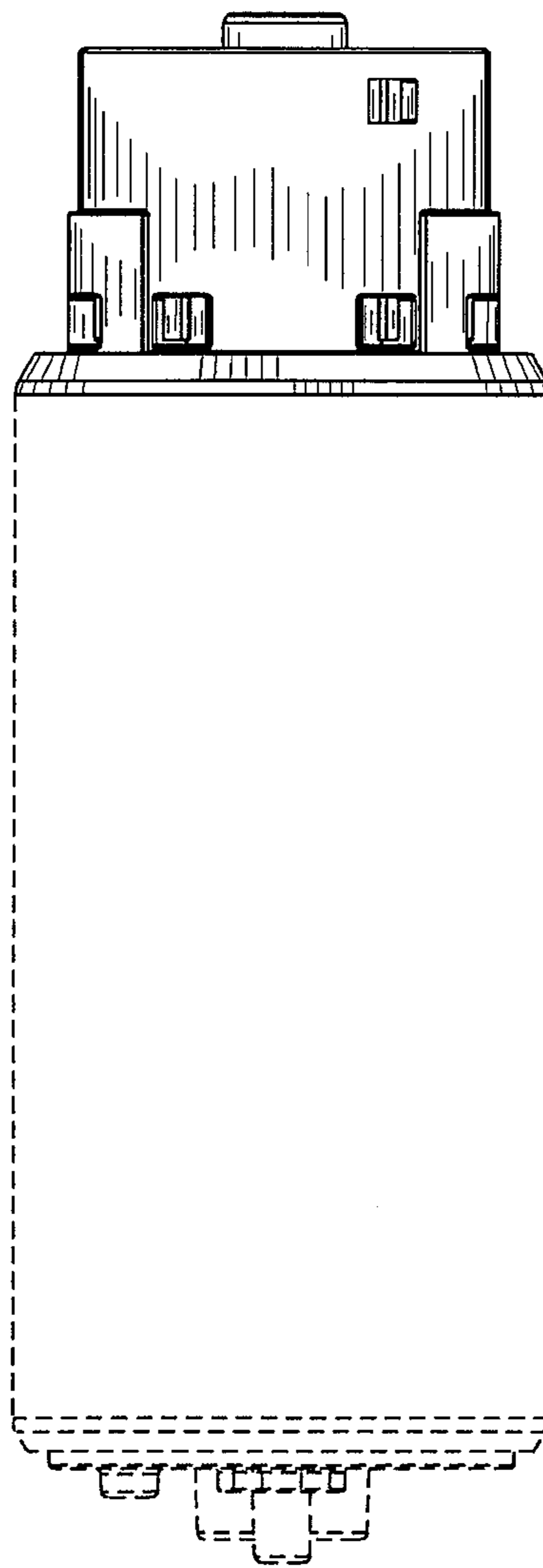

FIG. 44

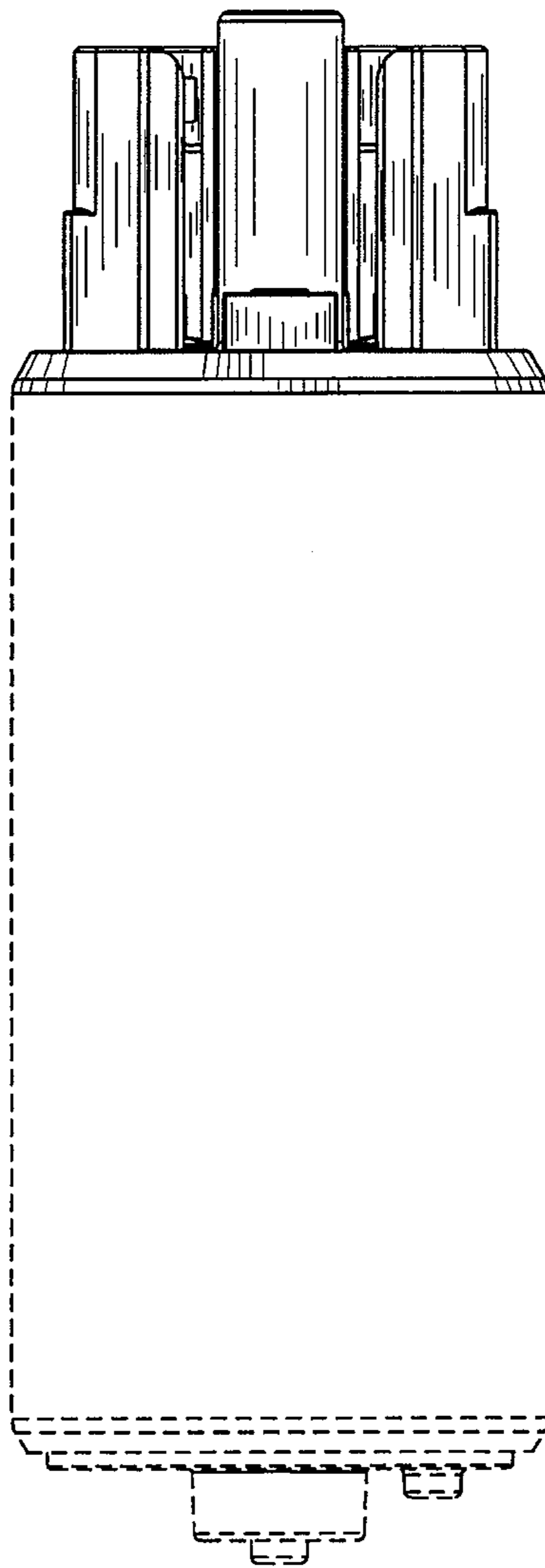

FIG. 45

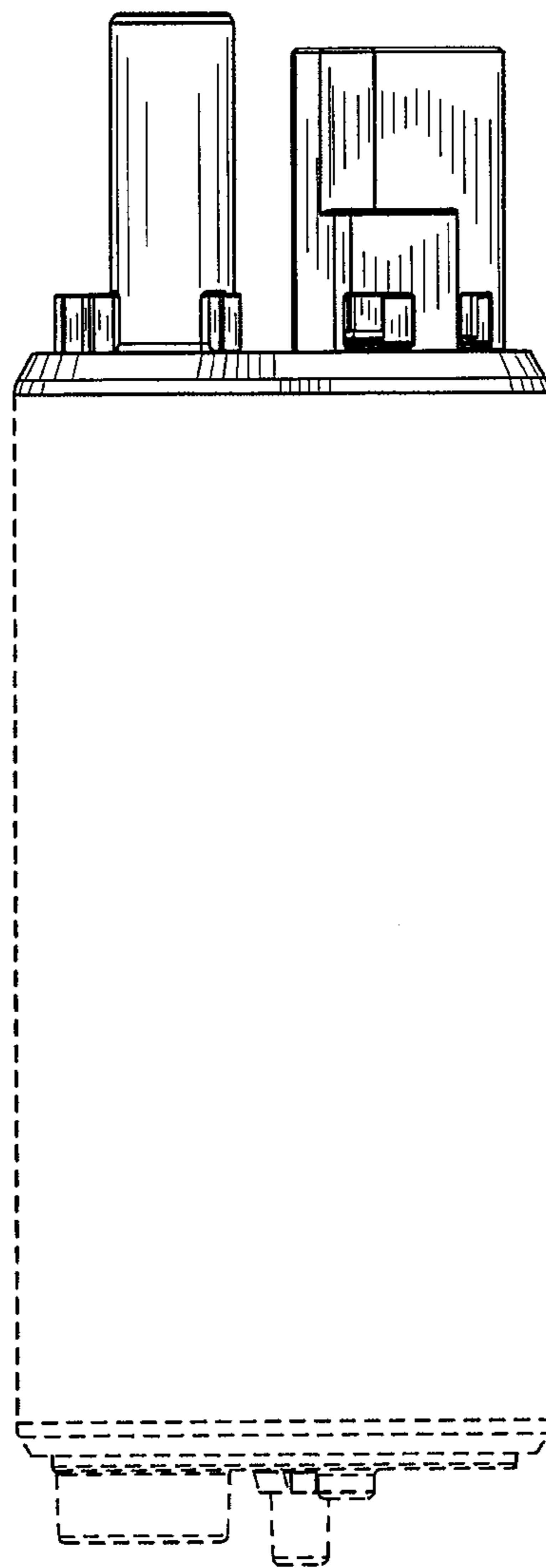

FIG. 46

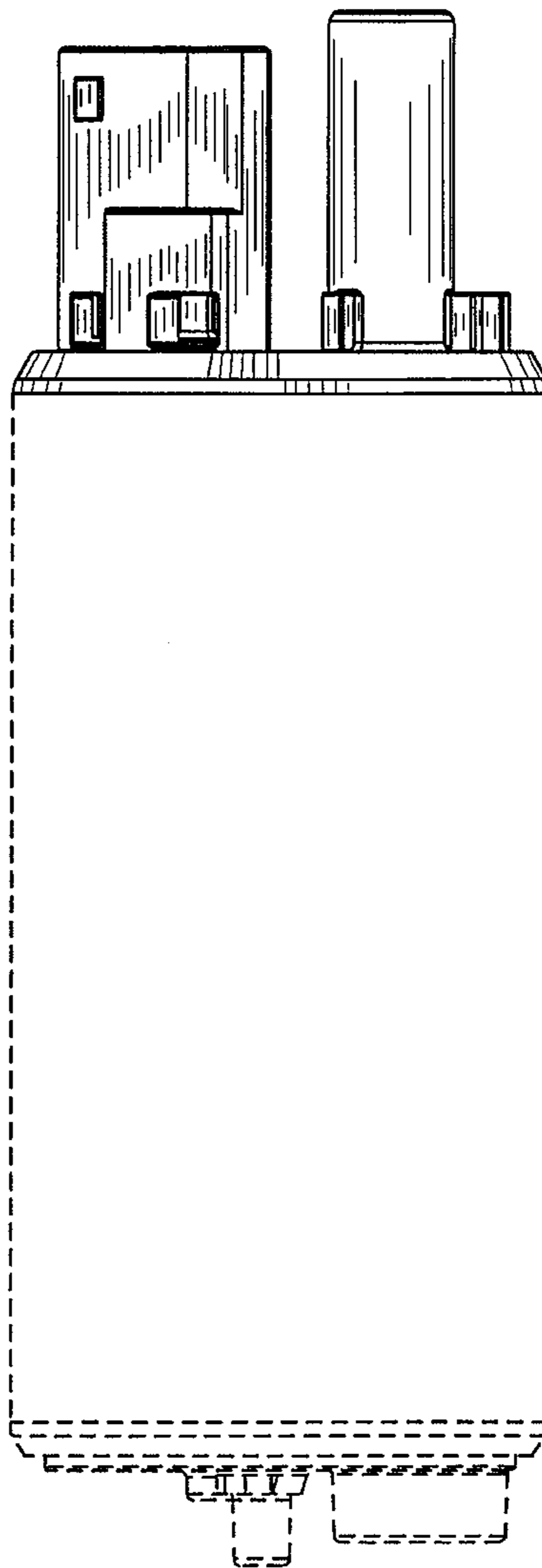

FIG. 47

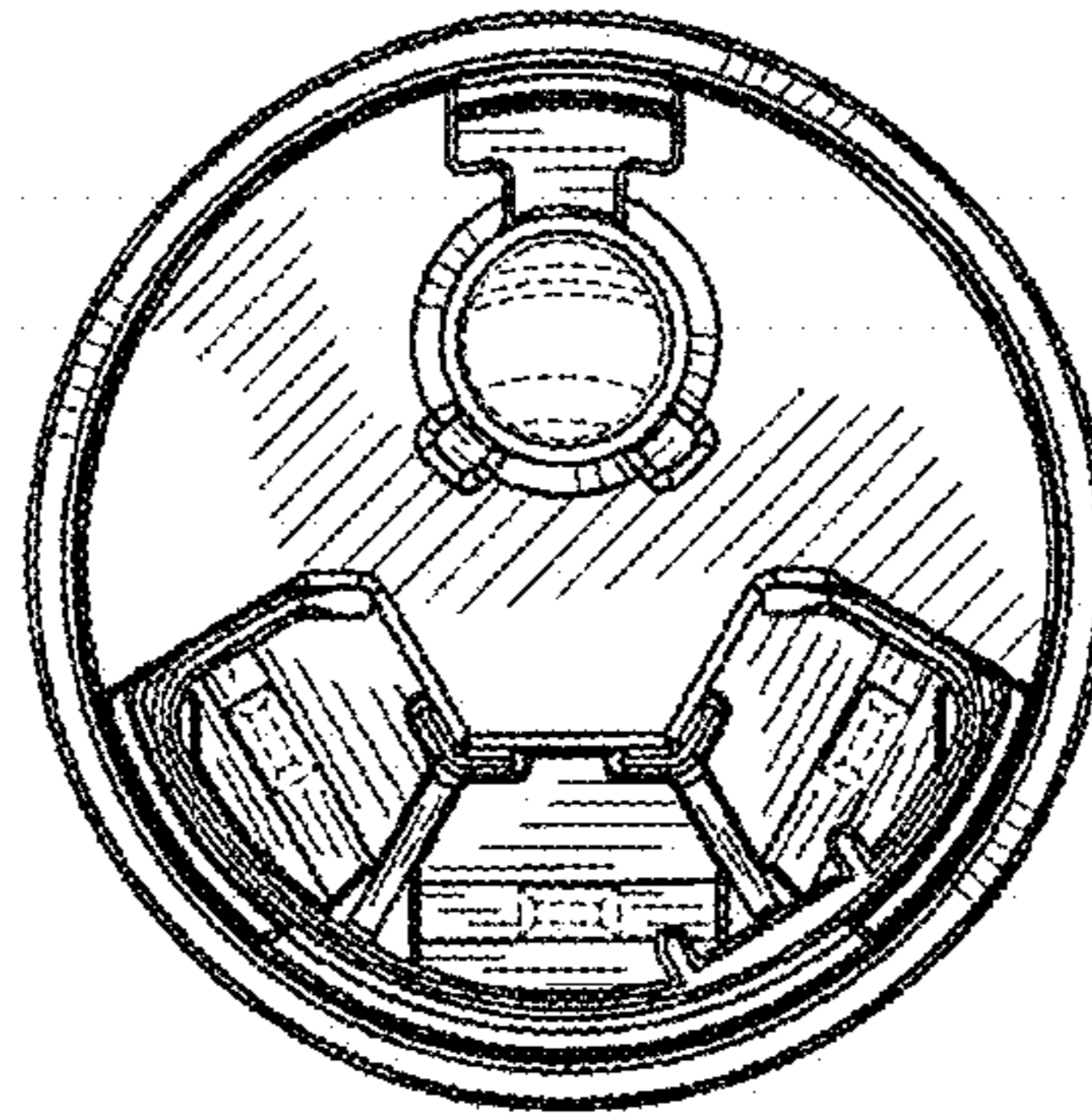

FIG. 48

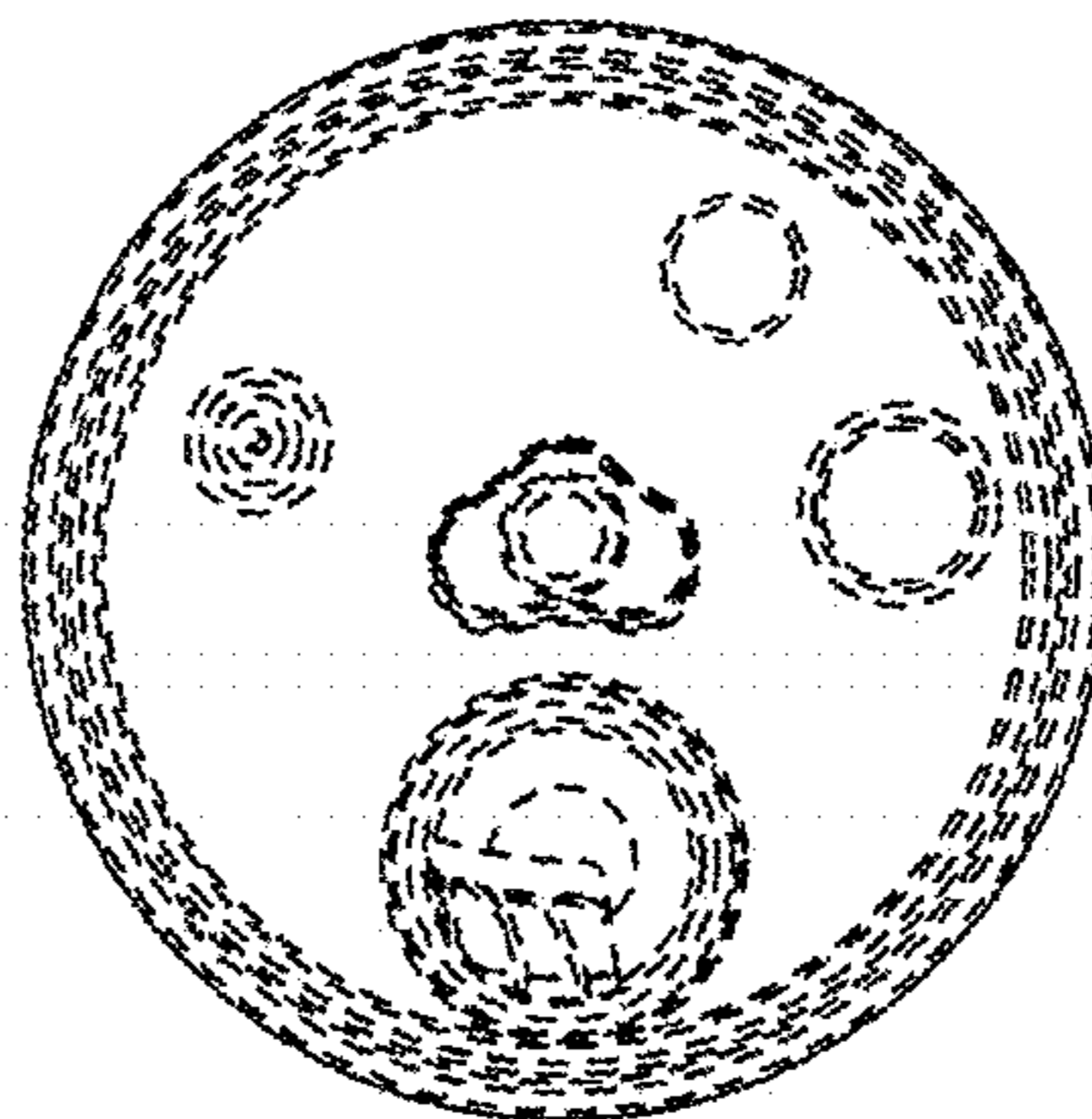

FIG. 49

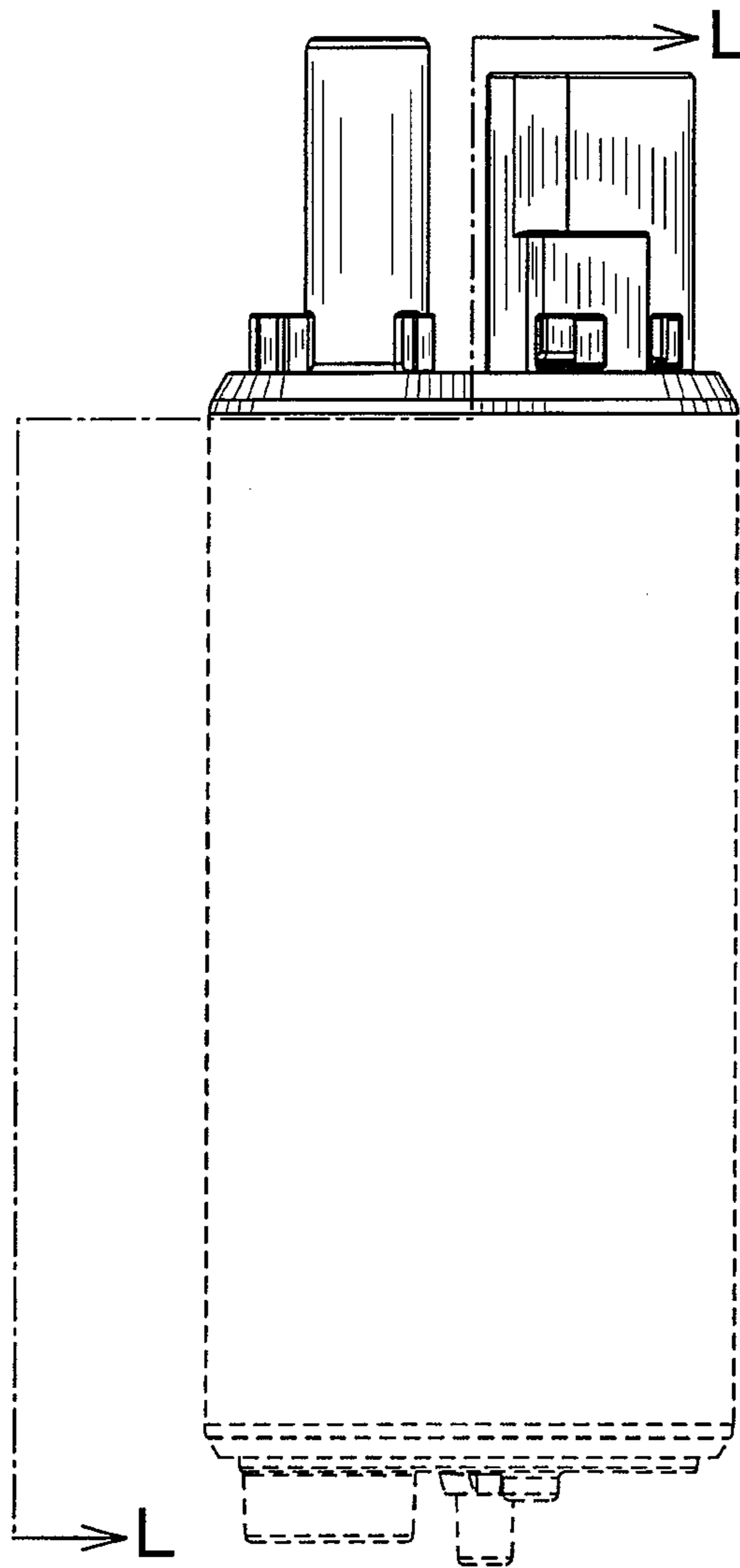

FIG. 50

