



US00D771616S

(12) **United States Design Patent** (10) **Patent No.:** **US D771,616 S**  
**Bo** (45) **Date of Patent:** **\*\* Nov. 15, 2016**

(54) **PHONE STAND**

(71) Applicant: **Anhui Inno-Sign International Co., Ltd.**, Hefei (CN)

(72) Inventor: **Jin Bo**, Hefei (CN)

(73) Assignee: **Anhui Inno-Sign International Co., Ltd.** (CN)

(\*\*) Term: **15 Years**

(21) Appl. No.: **29/529,844**

(22) Filed: **Jun. 10, 2015**

(51) **LOC (10) Cl.** ..... **14-03**

(52) **U.S. Cl.**  
USPC ..... **D14/253**

(58) **Field of Classification Search**  
USPC ..... D14/253, 251, 252, 447, 451, 452, 440, D14/434, 458, 432, 439, 457, 460, 238.1, D14/140, 142, 149, 217, 148, 140.8, D14/140.11; D13/107, 108; D12/415, 223, D12/114; D3/218; D16/242-245, 250, 237; D6/675, 672, 673, 675.4, 553, 676, 310  
CPC ..... B60R 2011/0008; B60R 11/02; B60R 11/0241; B60R 11/0258; B60R 11/0252; B60R 2011/0294; F16M 11/00; F16M 11/04; F16M 11/041; F16M 11/02; F16M 11/06; H04M 1/02; A47F 7/022; B62J 11/00  
See application file for complete search history.

(56) **References Cited**

**U.S. PATENT DOCUMENTS**

D364,158 S \* 11/1995 Branch ..... D14/137  
D557,693 S \* 12/2007 Kim ..... D13/108  
D590,404 S \* 4/2009 Kim ..... D14/447

D663,726 S \* 7/2012 Gourley ..... D14/251  
D671,934 S \* 12/2012 Alman ..... D14/253  
D674,381 S \* 1/2013 Ma ..... D14/253  
D674,396 S \* 1/2013 Yang ..... D14/447  
D684,963 S \* 6/2013 Goodrich ..... D14/253  
D688,235 S \* 8/2013 Song ..... D14/253  
D729,248 S \* 5/2015 Porter ..... D14/434

\* cited by examiner

*Primary Examiner* — Susan Bennett Hattan

*Assistant Examiner* — Janice Hallmark

(74) *Attorney, Agent, or Firm* — Richards Patent Law P.C.

(57) **CLAIM**

The ornamental design for a phone stand, as shown and described.

**DESCRIPTION**

FIG. 1 is a first perspective view of the phone stand; FIG. 2 is a second perspective view of the phone stand; FIG. 3 is a front side view of the phone stand; FIG. 4 is a back side view of the phone stand; FIG. 5 is a right side view of the phone stand; FIG. 6 is a left side view of the phone stand; FIG. 7 is a bottom view of the phone stand; and, FIG. 8 is a top view of the phone stand.

**1 Claim, 8 Drawing Sheets**

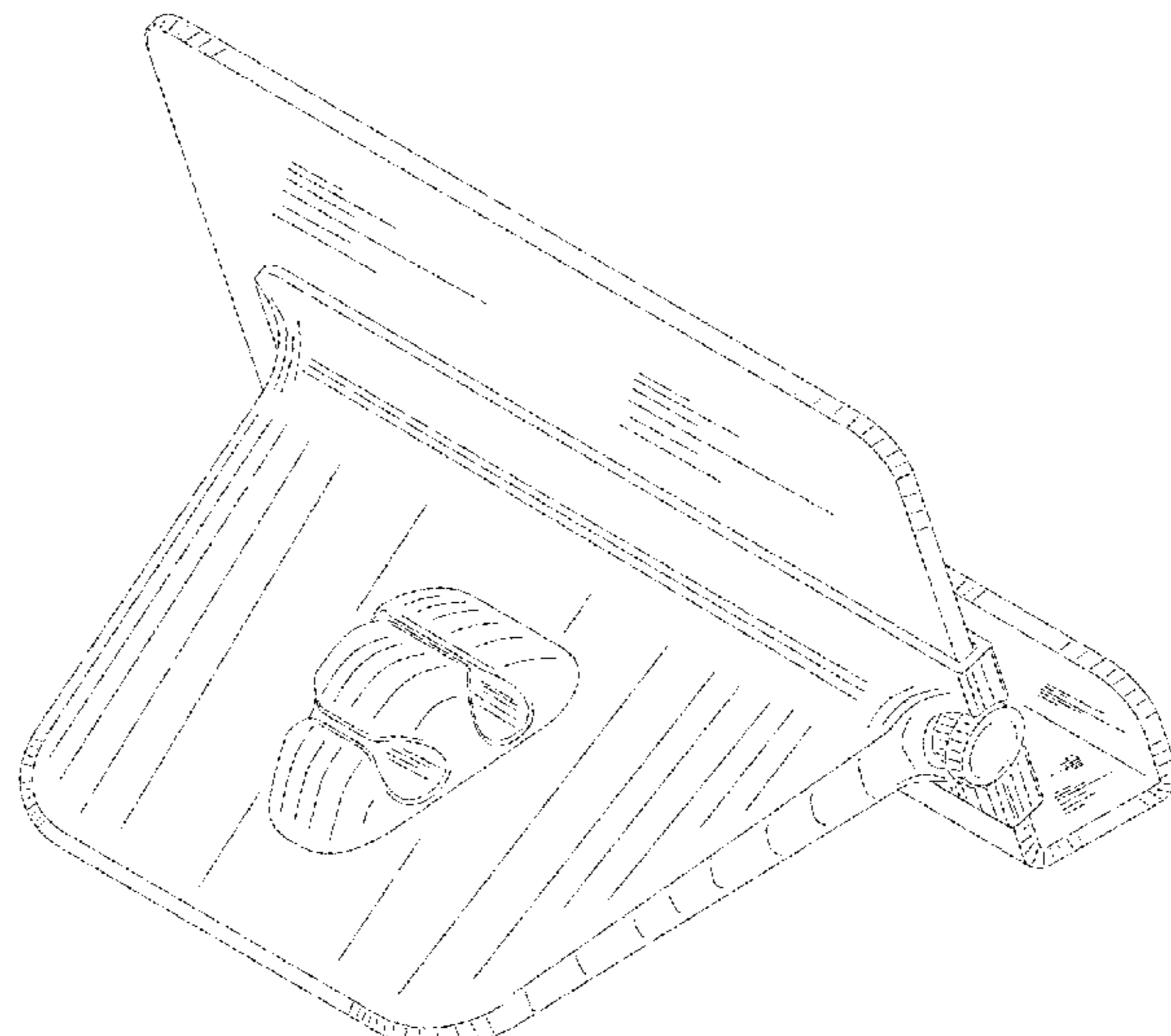
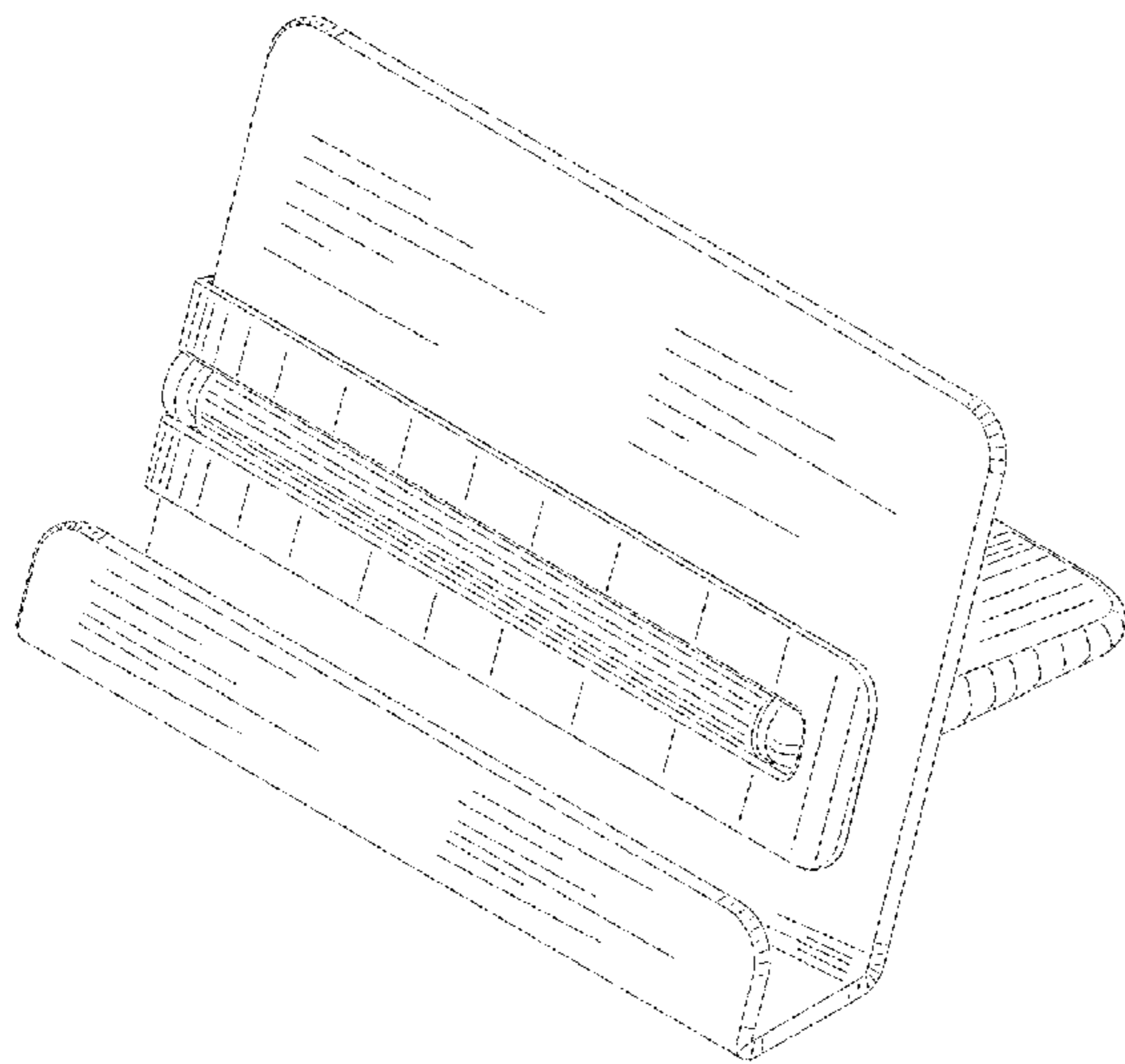

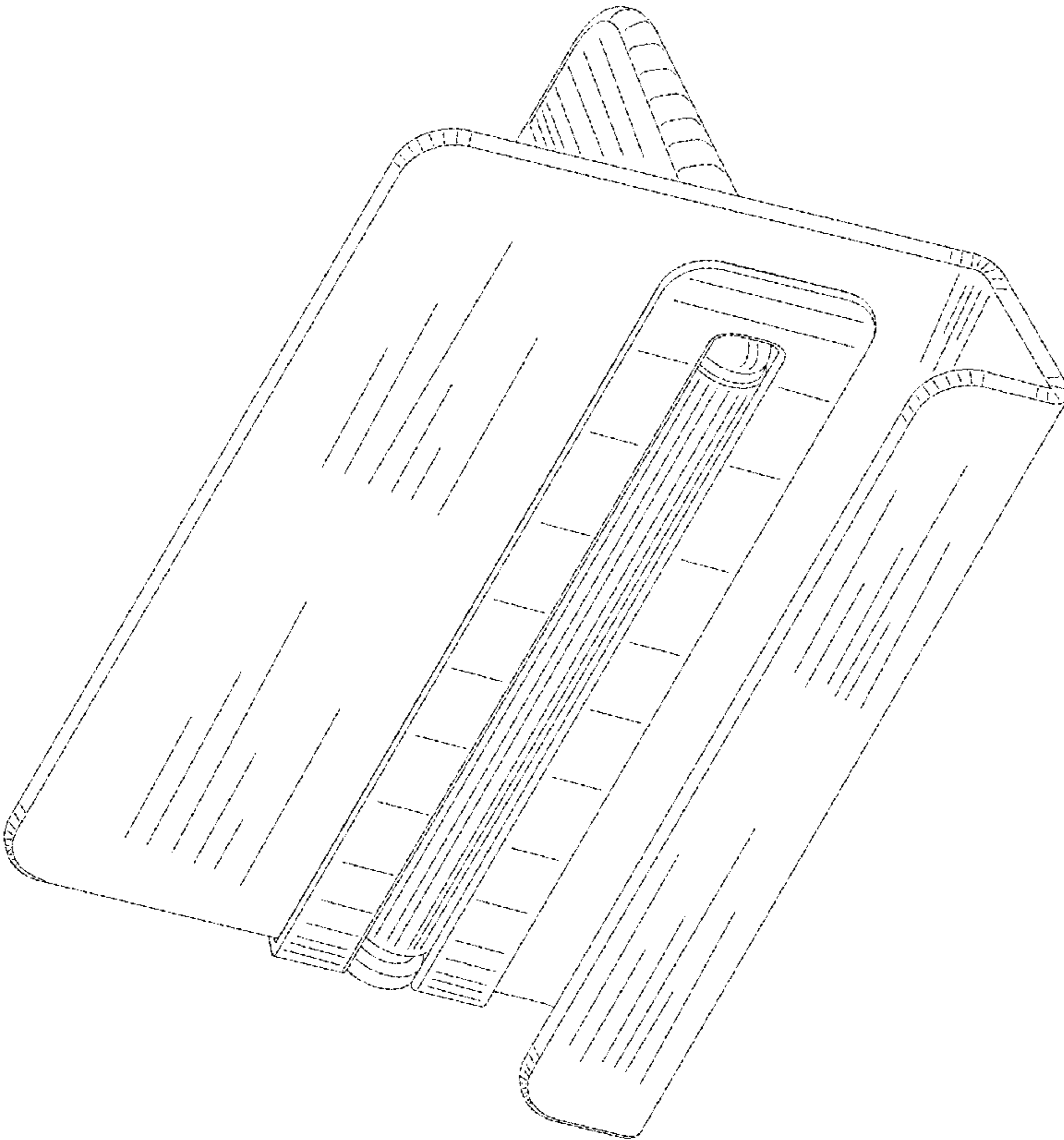

FIG.1

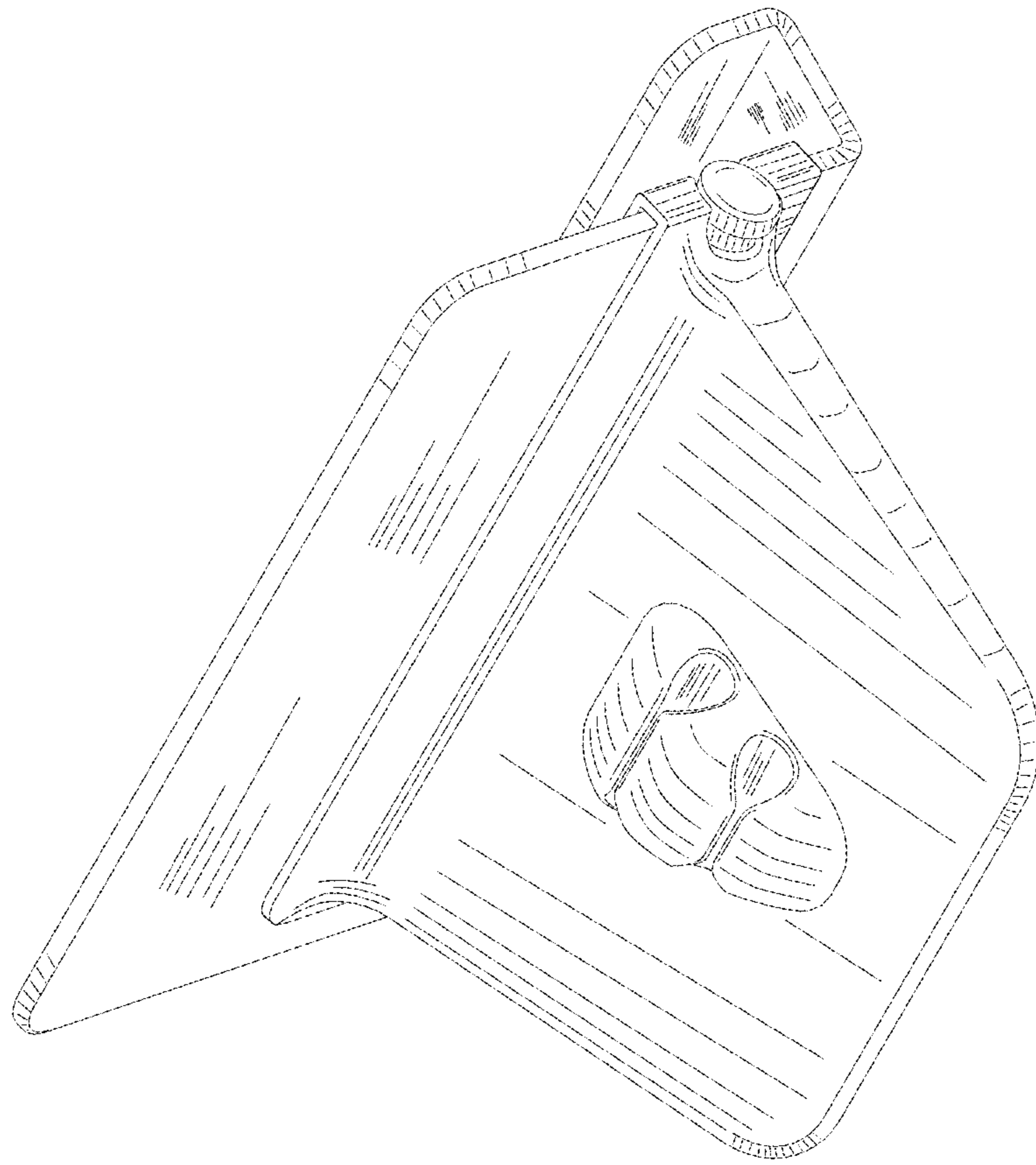

FIG.2

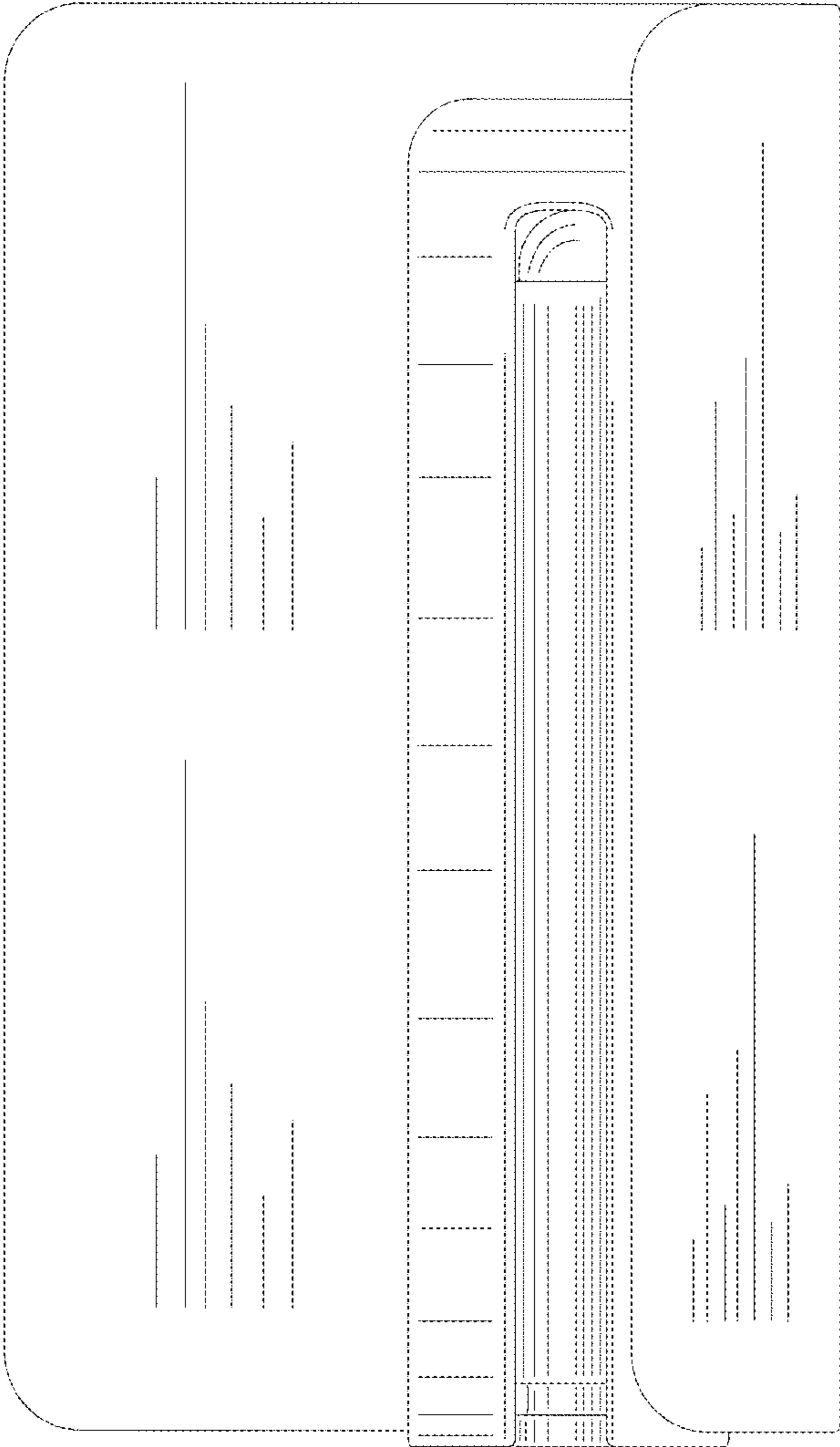

FIG.3

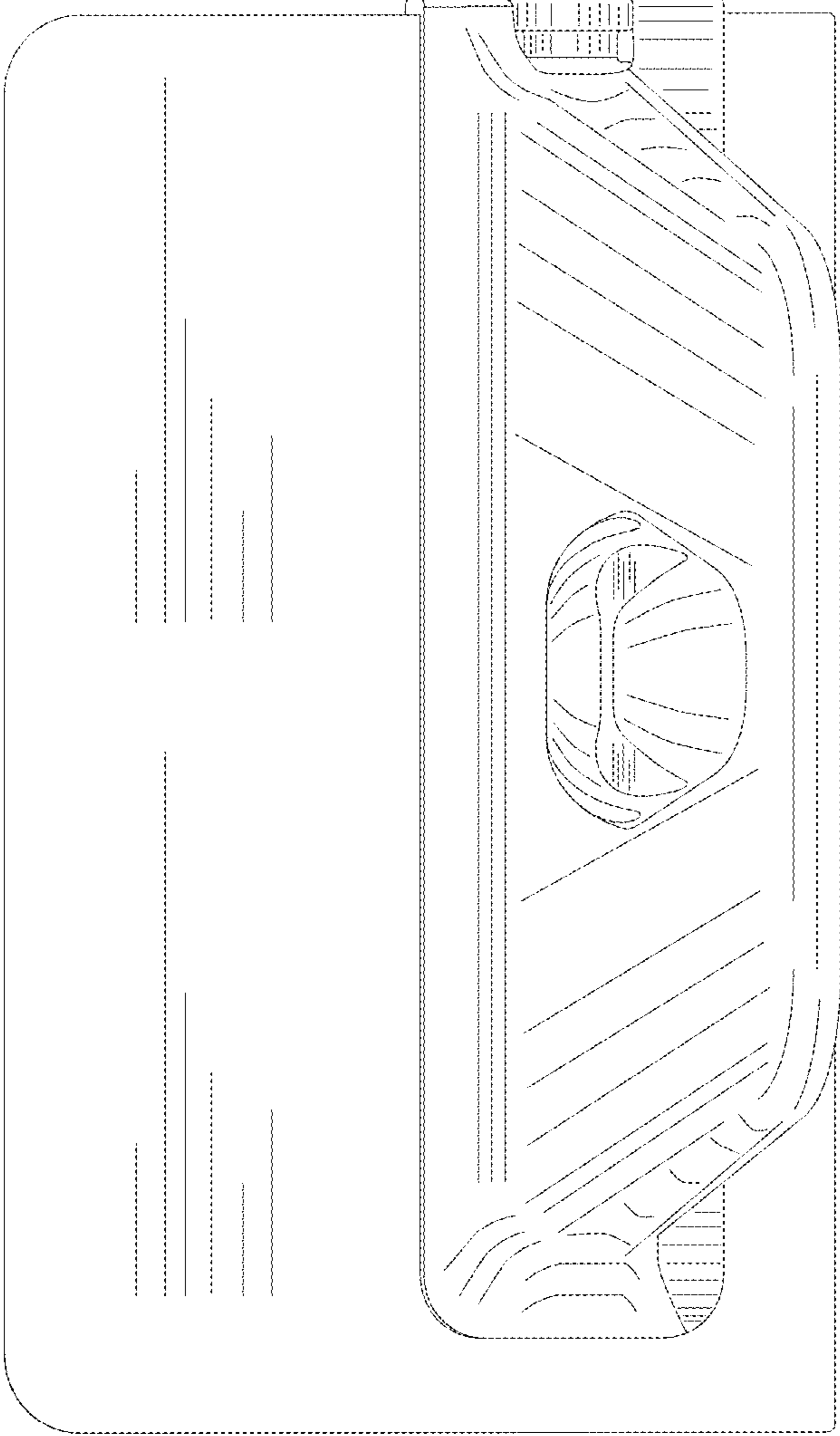

FIG.4

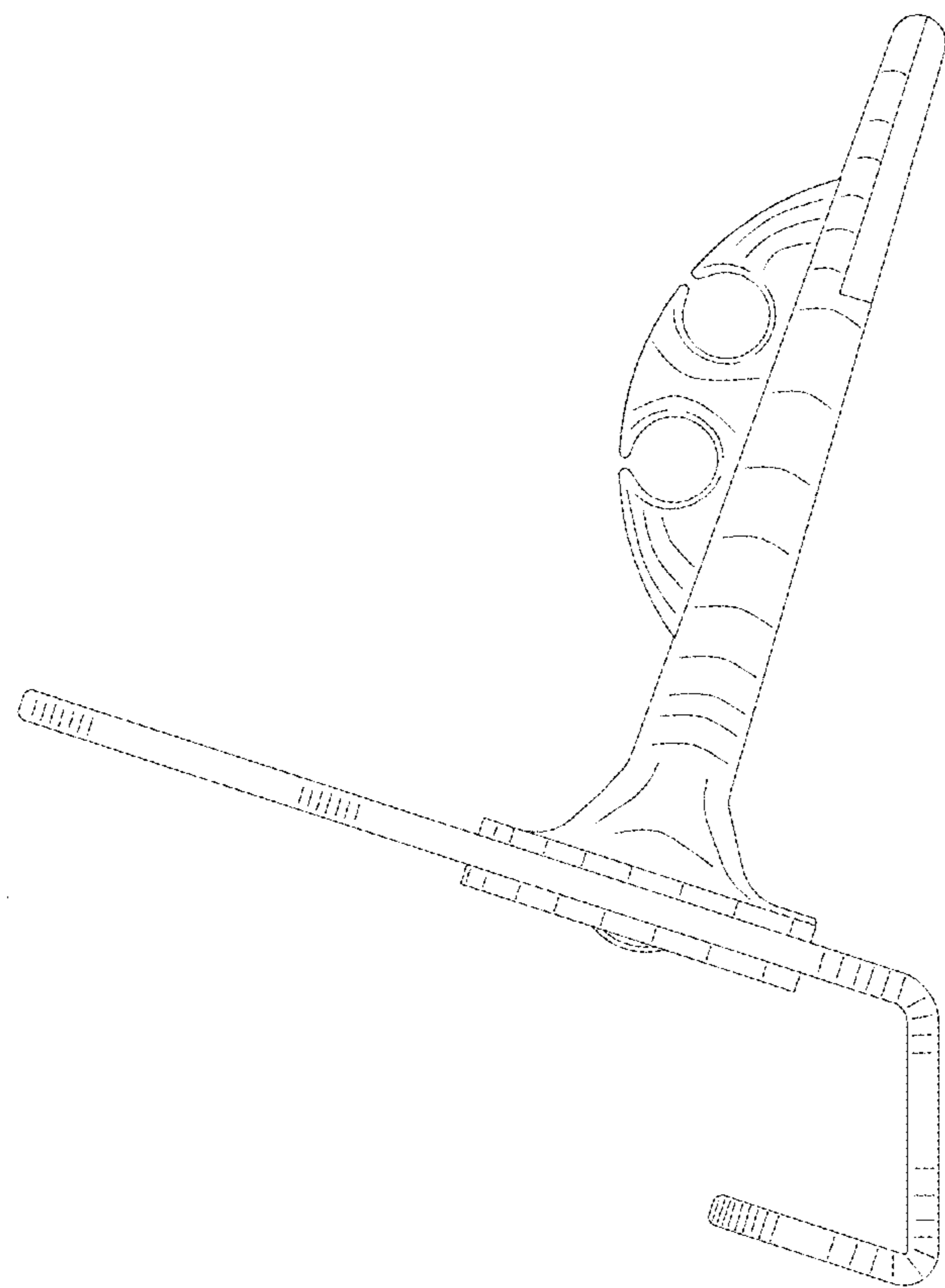

FIG. 5

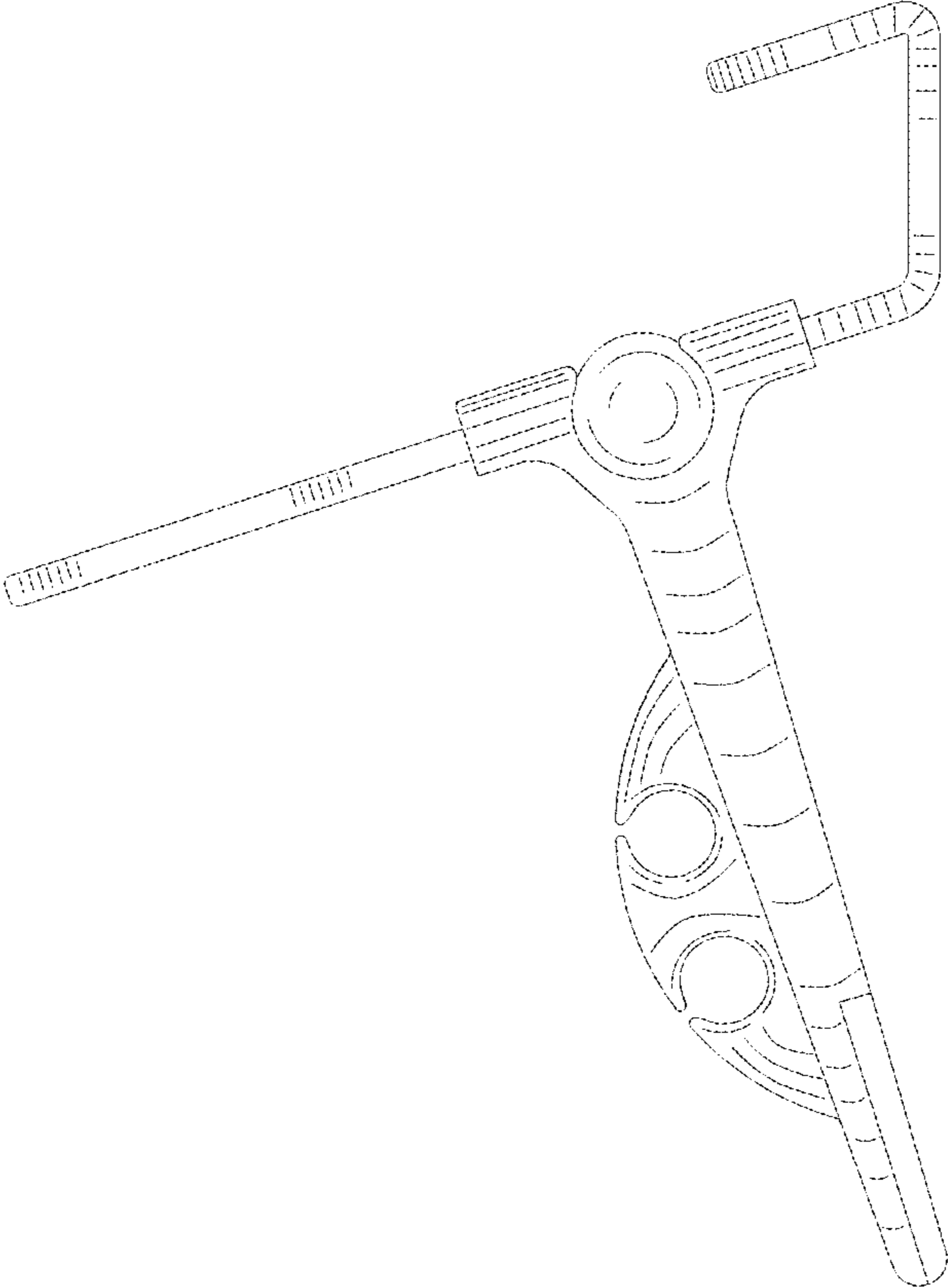

FIG.6

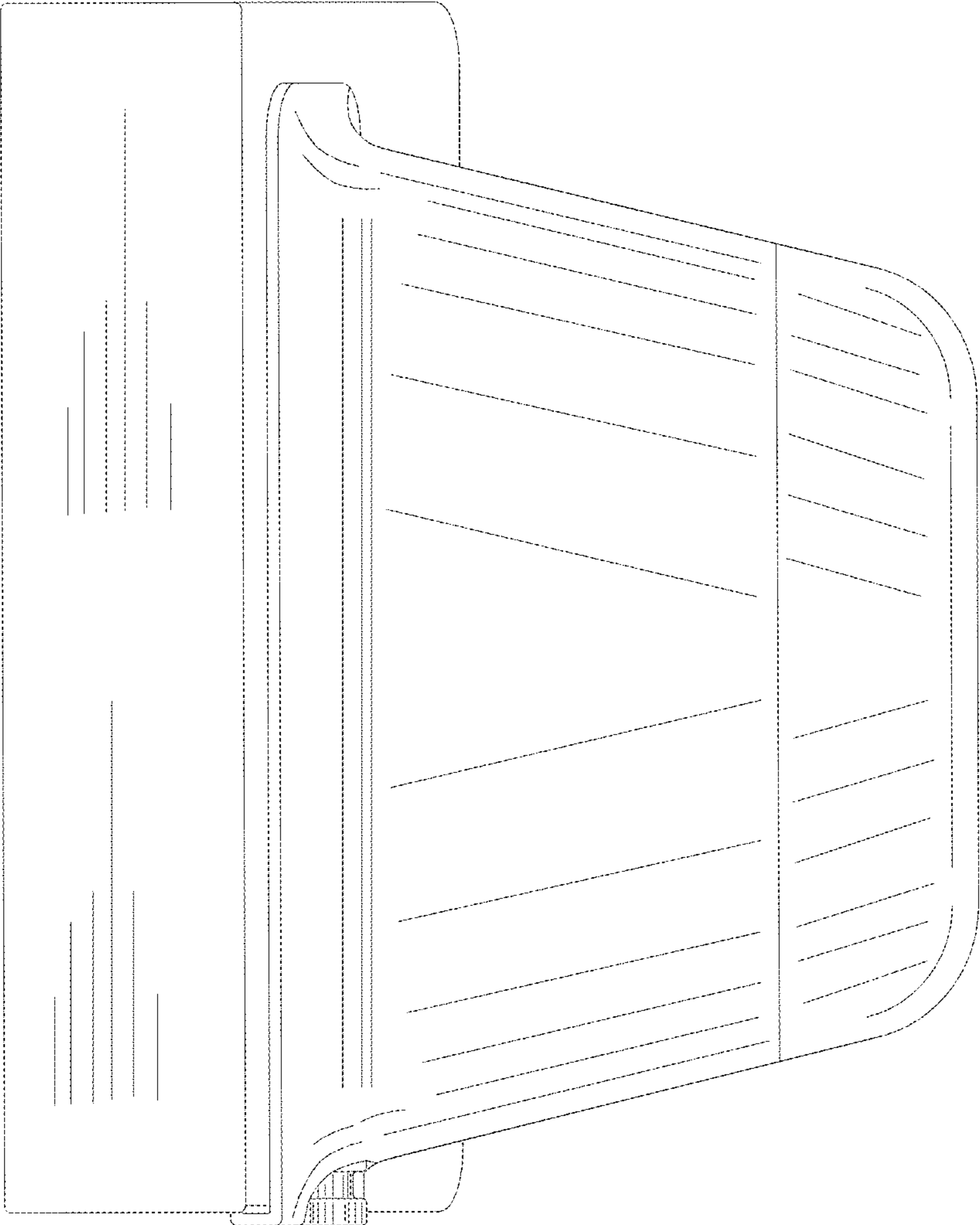

FIG.7



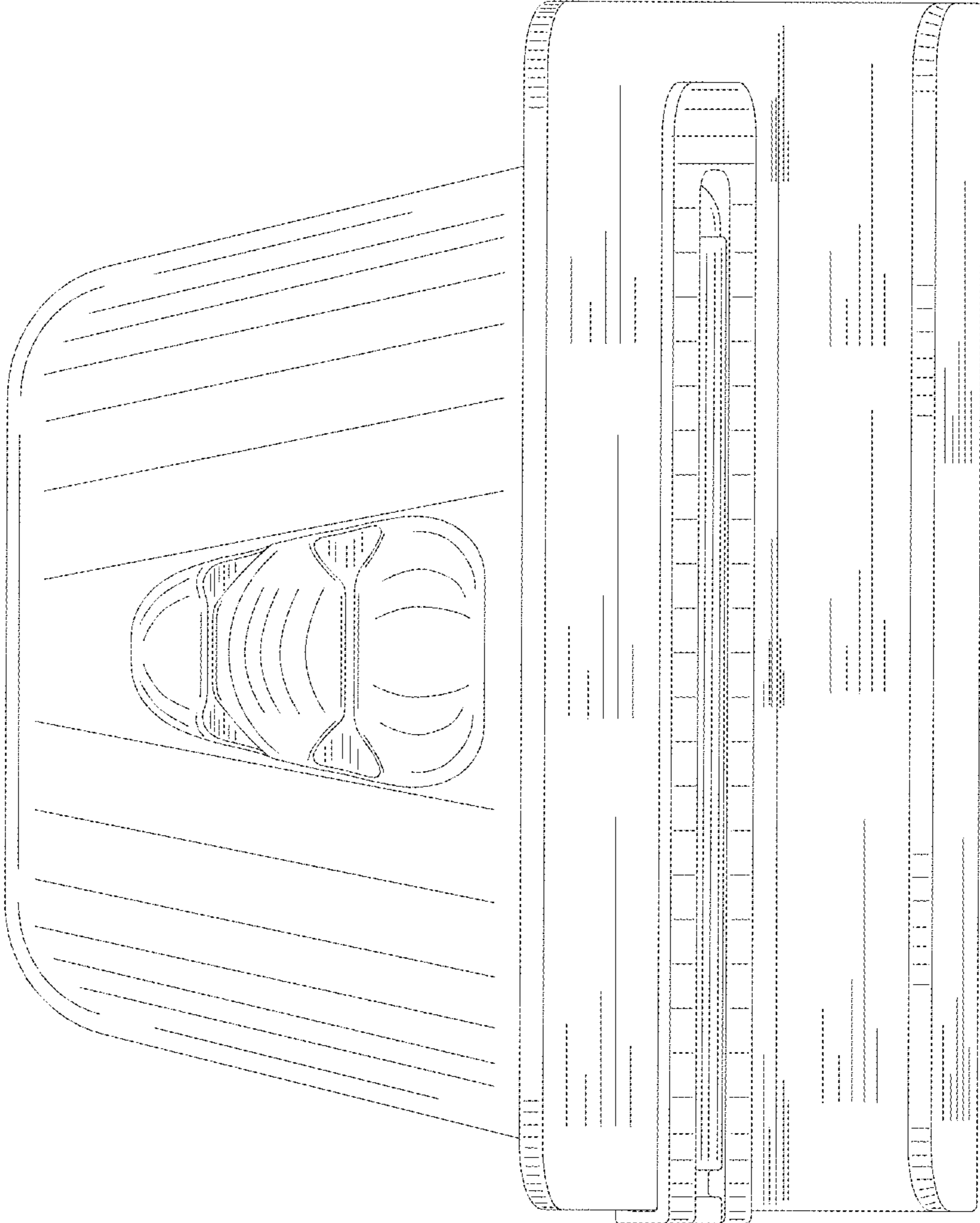

FIG.8