



US00D771534S

(12) **United States Design Patent** (10) **Patent No.:** **US D771,534 S**
Bucher et al. (45) **Date of Patent:** **** Nov. 15, 2016**

(54) **VEHICLE FRONT LOWER GRILLE AND BUMPER COVER**

(71) Applicant: **Ford Global Technologies, LLC**, Dearborn, MI (US)

(72) Inventors: **George Bucher**, Dearborn, MI (US); **Dean Carbis**, Bloomfield Hills, MI (US)

(73) Assignee: **Ford Global Technologies, LLC**, Dearborn, MI (US)

(**) Term: **15 Years**

(21) Appl. No.: **29/543,678**

(22) Filed: **Oct. 27, 2015**

(51) **LOC (10) Cl.** **12-08**

(52) **U.S. Cl.**
USPC **D12/169**

(58) **Field of Classification Search**
USPC D12/86-92, 163-172; 293/102-155; 296/35.2, 193.09, 193.1, 203.02
CPC B60R 19/02; B60R 19/023; B60R 19/18; B60R 19/24; B60R 19/44; B60R 19/48; B60R 19/56; B60R 2019/527; B60R 2019/1886

See application file for complete search history.

(56) **References Cited**

U.S. PATENT DOCUMENTS

D570,751 S * 6/2008 Choi D12/169
D580,318 S 11/2008 Gueler et al.
D634,680 S * 3/2011 Iida D12/169
D634,681 S * 3/2011 Hirabayashi D12/169
D644,963 S 9/2011 Tonello
D644,964 S 9/2011 Tonello
D644,970 S 9/2011 Messale
D647,435 S 10/2011 Tonello
D650,725 S 12/2011 Tonello
D664,481 S * 7/2012 Platto D12/163
D669,003 S * 10/2012 Koizumi D12/169

D670,624 S * 11/2012 Koehl D12/169
D692,798 S * 11/2013 Thurber D12/91
D703,118 S * 4/2014 Gueler D12/169
D703,593 S * 4/2014 Gueler D12/173
D727,211 S * 4/2015 Rupar D12/91
D727,221 S * 4/2015 Rupar D12/163

(Continued)

FOREIGN PATENT DOCUMENTS

EP 40201100581.6 2/2011

OTHER PUBLICATIONS

Wendler, Andrew. "2017 Ford Escape Debuts, Cranks up the Technology." caranddriver.com. Nov. 2015. Accessed Aug. 2, 2016. Available online at URL: <<http://www.caranddriver.com/news/2017-ford-escape-official-photos-and-info-news>>.*

(Continued)

Primary Examiner — Cathron Brooks
Assistant Examiner — Christian P McLean
(74) *Attorney, Agent, or Firm* — Damian Porcari

(57) **CLAIM**
The ornamental design for a vehicle front lower grille and bumper cover, as shown and described.

DESCRIPTION

FIG. 1 is a bottom front perspective and left view of the vehicle front lower grille and bumper cover, showing our new design;
FIG. 2 is a bottom front perspective and right view thereof;
FIG. 3 is a top rear perspective view thereof;
FIG. 4 is a front elevational view thereof;
FIG. 5 is a rear elevational view thereof;
FIG. 6 is a left side elevational view thereof;
FIG. 7 is a right side elevational view thereof;
FIG. 8 is a top plan view thereof; and,
FIG. 9 is a bottom plan view thereof.

1 Claim, 9 Drawing Sheets

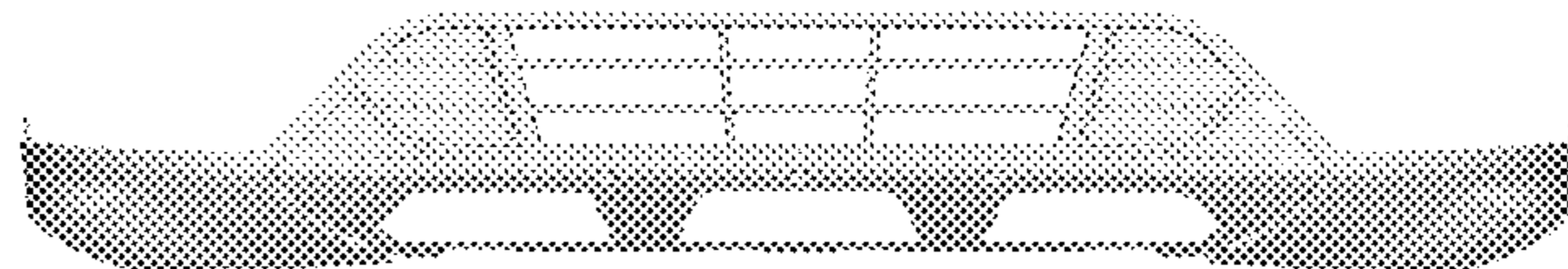
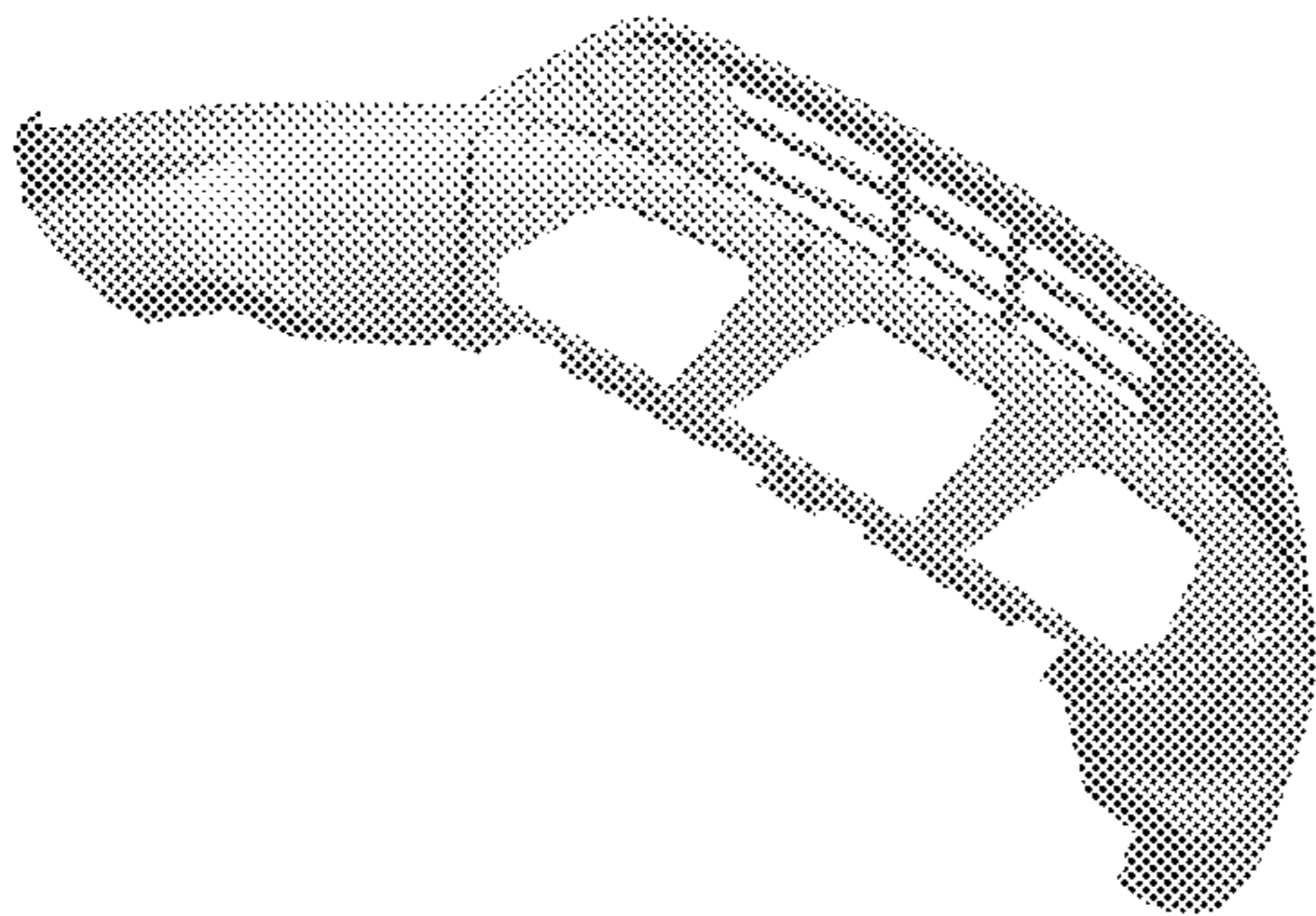

(56)

References Cited

U.S. PATENT DOCUMENTS

D727,224 S * 4/2015 Wolff D12/169
D731,371 S * 6/2015 Morikawa D12/169
D736,120 S * 8/2015 Blanski D12/91
D740,184 S * 10/2015 Blanski D12/163
D741,223 S * 10/2015 Kim D12/91

OTHER PUBLICATIONS

“2017 Ford Escape—Interior and Exterior Walkaround.” YouTube.com. 0:37. Published Nov. 16, 2015. Accessed Aug. 2, 2016. Available online at URL: <<https://www.youtube.com/watch?v=gvqk88X6vow>>.*

Bob Nagy <http://www.kbb.com/car-news/all-the-latest/2017-Ford-escape-spied/2000012056> 2017 Ford Escape spied, dated May 15, 2015.

Mark McNabb <http://www.topspeed.com/trucks/truck-reviews/Ford/2017-Ford-escape-ar169435.html> 2017 Ford Escape dated May 18, 2015.

Alexander Stoklosa <http://www.caranddriver/news/2017-Ford-escape-spy-photos-news> 2017 Ford Escape Spy Photos dated May 2015.

Unknown <http://www.autoblog.com/2015/06/25/2017-Ford-escape-spy-shots> New Ford Escape spied inside and out dated Jun. 25, 2015.

* cited by examiner

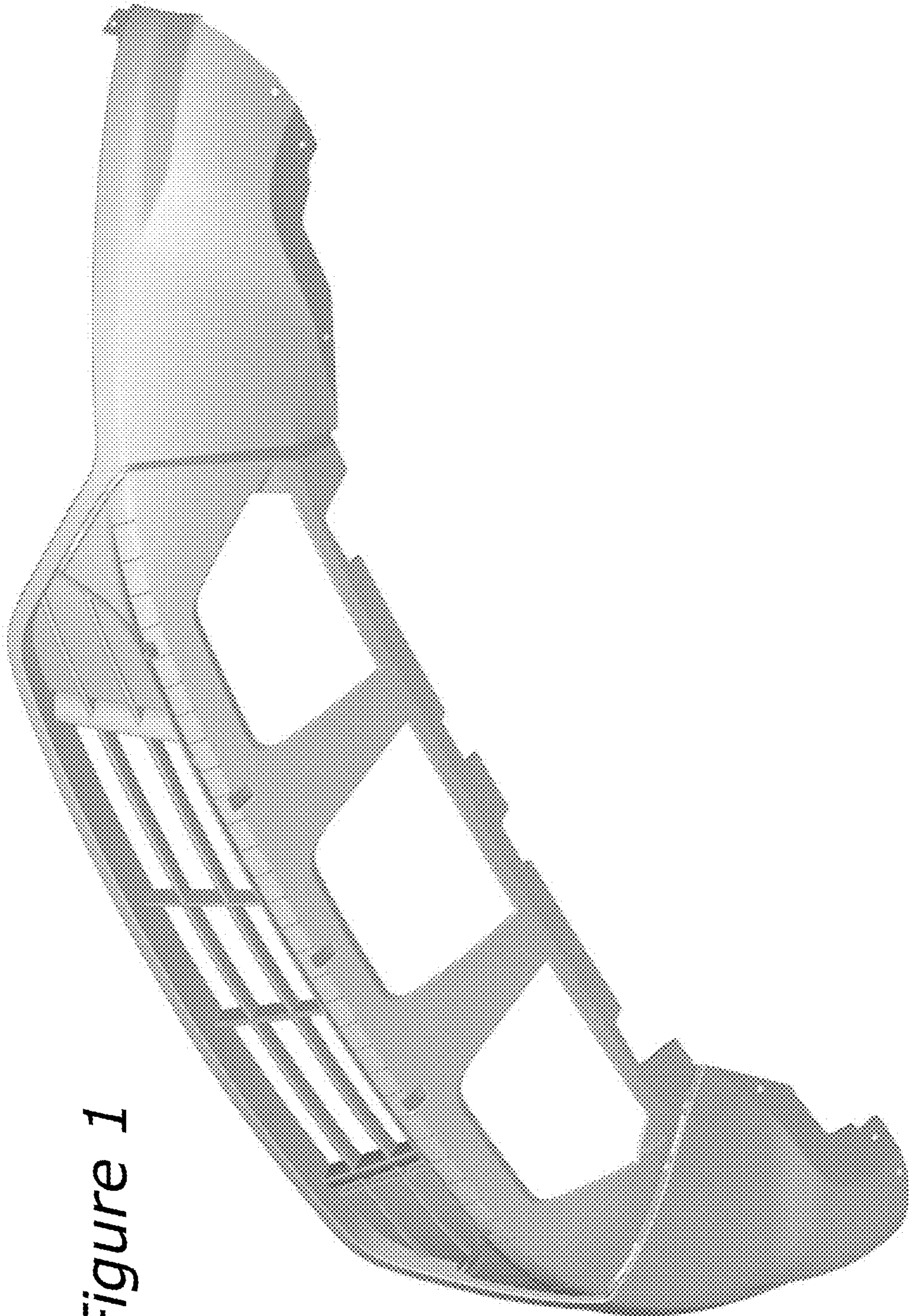

Figure 1

Figure 2





Figure 3

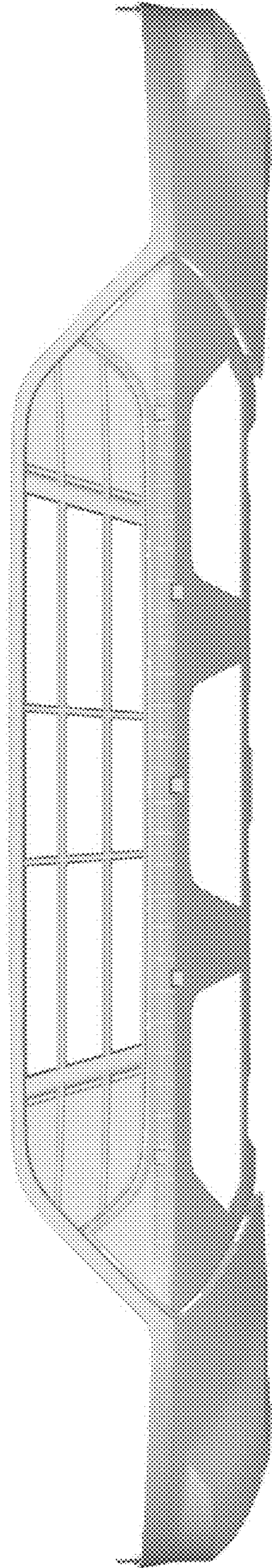

Figure 4

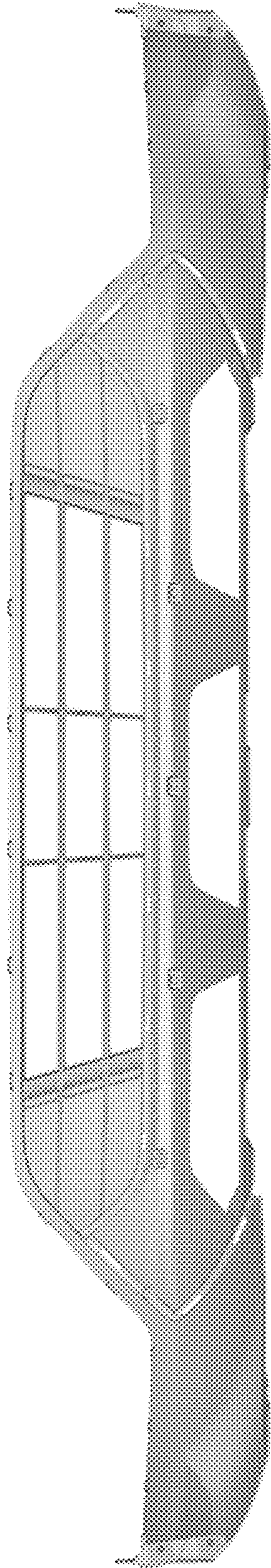

Figure 5

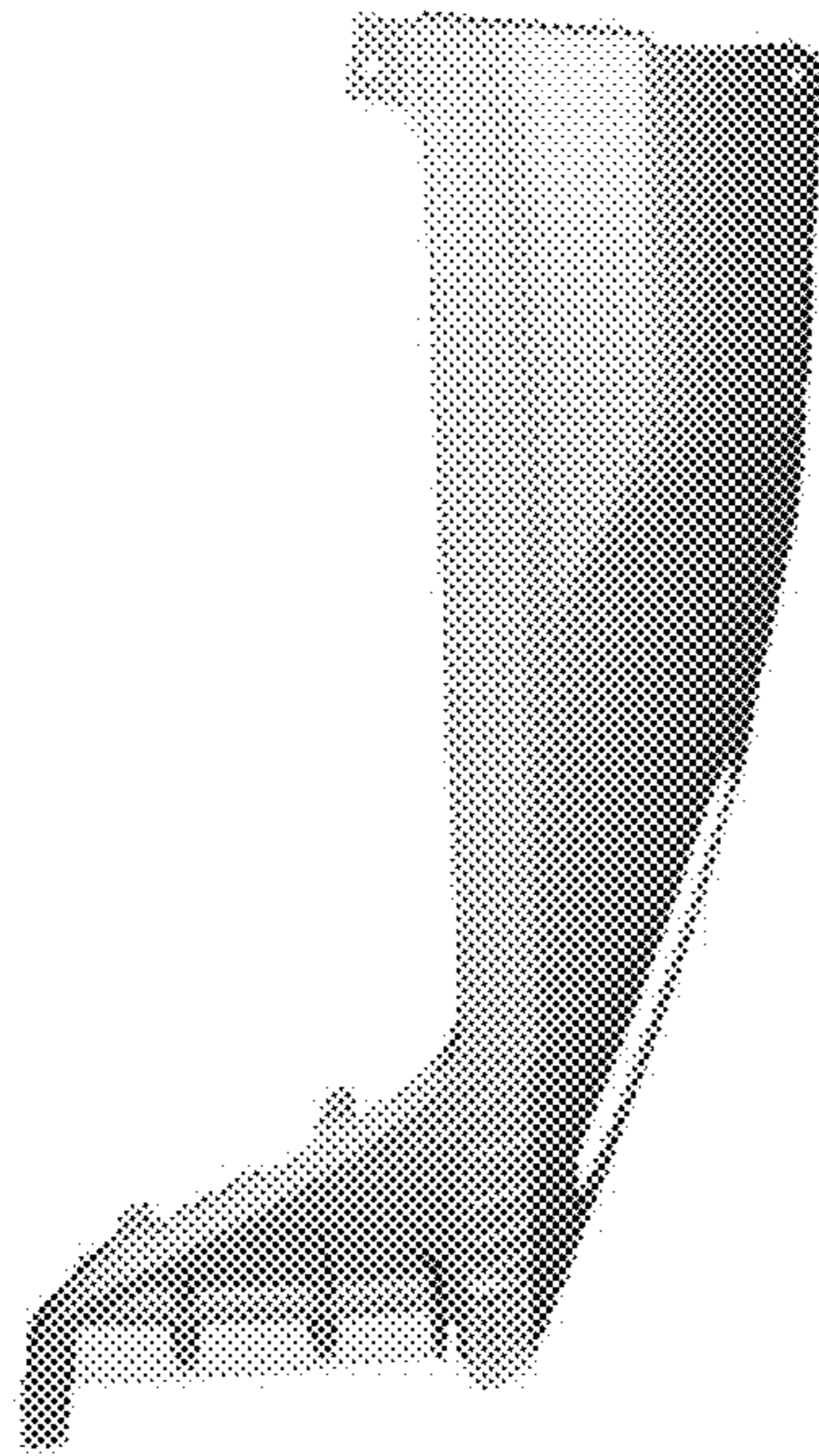

Figure 6

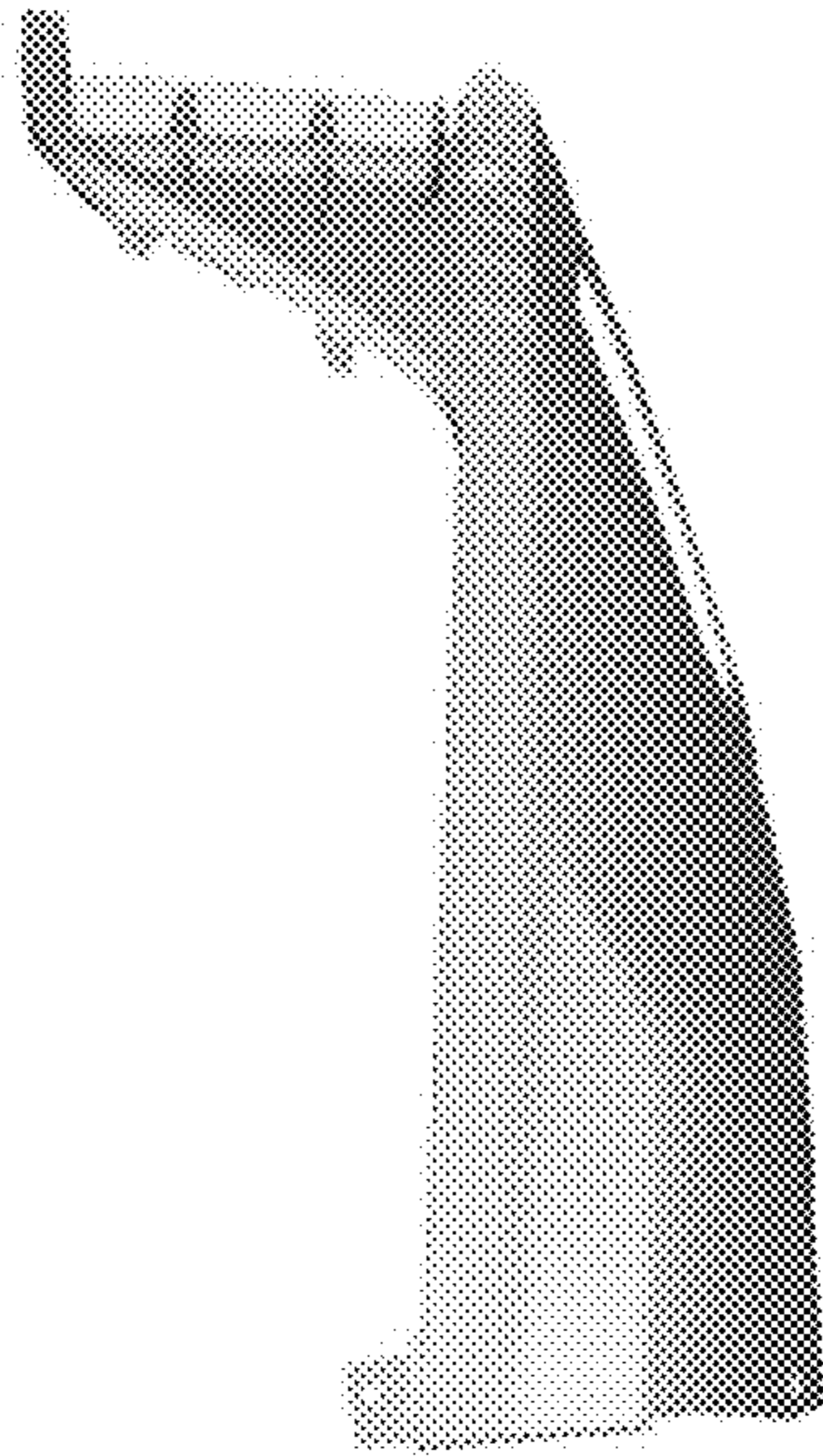

Figure 7

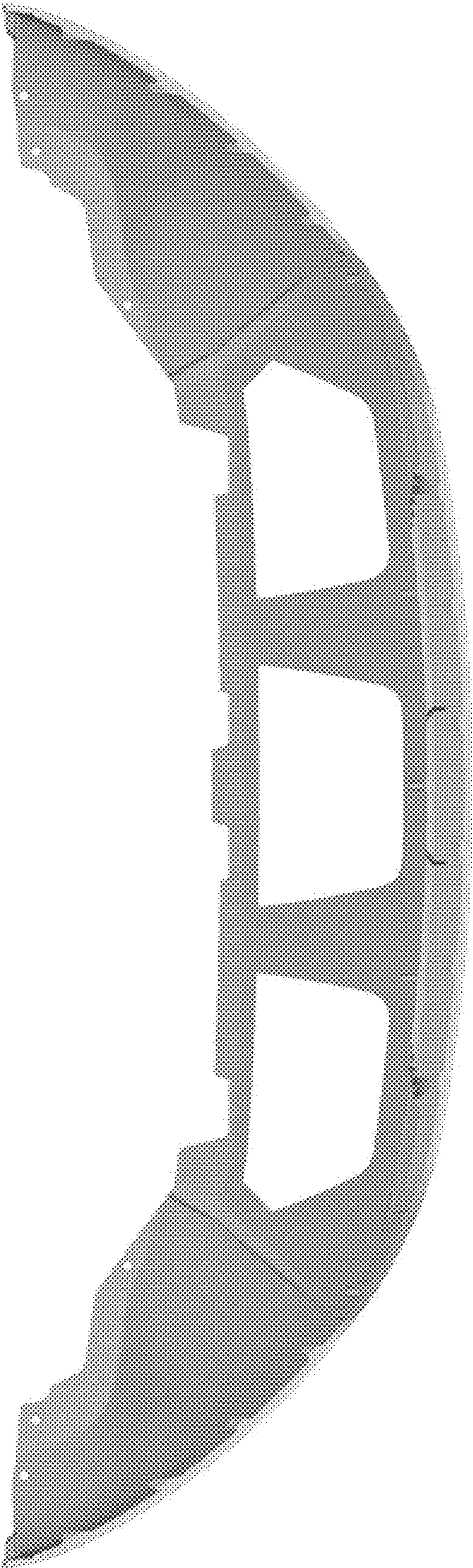

Figure 8

Figure 9

