



US00D771417S

(12) **United States Design Patent** (10) **Patent No.:** **US D771,417 S**  
**Mason** (45) **Date of Patent:** **\*\* Nov. 15, 2016**

(54) **VERTICAL SUPPORT FOR A DISPLAY UNIT**

(71) Applicant: **NEW DIMENSIONS RESEARCH CORPORATION**, Melville, NY (US)

(72) Inventor: **Timothy L. Mason**, Melville, NY (US)

(73) Assignee: **New Dimensions Research Corporation**, Melville, NY (US)

(\*\*) Term: **14 Years**

(21) Appl. No.: **29/512,802**

(22) Filed: **Dec. 23, 2014**

(51) **LOC (10) Cl.** ..... **06-06**

(52) **U.S. Cl.**  
USPC ..... **D6/675.1; D6/706**

(58) **Field of Classification Search**  
USPC ..... D6/675.1, 479, 707.17, 449, 712, 702, D6/706, 705; 248/668, 449, 462; D8/373, D8/383; 52/656.8  
CPC ..... A47F 5/13; A47F 5/0884; A47F 7/00; A47B 96/07; A47B 96/021; A47B 96/06  
See application file for complete search history.

(56) **References Cited**

**U.S. PATENT DOCUMENTS**

D150,315 S	7/1948	Richards
2,483,606 A	10/1949	Albach et al.
2,934,214 A	4/1960	Mogulescu et al.
3,788,241 A	1/1974	Ravreby
4,125,304 A	11/1978	Ebert
4,127,072 A	11/1978	Le Pon
4,428,487 A	1/1984	Hepp
4,474,416 A	10/1984	Rogahn
4,691,644 A	9/1987	Frydman
4,981,224 A	1/1991	Rushing
5,238,128 A	8/1993	Stoddard
5,240,127 A	8/1993	Levin et al.
5,433,326 A	7/1995	Horian

D374,579 S *	10/1996	Nilsson	.....	D6/709
5,566,961 A	10/1996	Snell et al.		
5,590,939 A	1/1997	Piontek		
5,722,544 A	3/1998	Williams		
5,975,660 A	11/1999	Tisbo et al.		
6,099,092 A	8/2000	Uffner et al.		
6,202,867 B1	3/2001	Di Blasi et al.		
D451,024 S	11/2001	Glauth et al.		

(Continued)

*Primary Examiner* — Rosemary K Tarcza

*Assistant Examiner* — James Thorn, Sr.

(74) *Attorney, Agent, or Firm* — Collard & Roe, P.C.

(57) **CLAIM**

The ornamental design for a vertical support for a display unit, as shown and described.

**DESCRIPTION**

FIG. 1 shows a perspective view of my design for a vertical support shelf for a display unit in a first orientation; FIG. 2 shows a front elevational view thereof; FIG. 3 shows a rear elevational view thereof; FIG. 4 shows right side elevational view thereof; FIG. 5 shows a left side elevational view thereof; FIG. 6 shows a top view thereof; FIG. 7 shows a bottom view thereof; FIG. 8 shows a perspective view of my design for a vertical support shelf for a display unit in a second orientation; FIG. 9 shows a front elevational view thereof; FIG. 10 shows a rear elevational view thereof; FIG. 11 shows a top view thereof; FIG. 12 shows a bottom view thereof; FIG. 13 shows a perspective view of my design for a vertical support shelf for a display unit in a third orientation; FIG. 14 shows a front elevational view thereof; FIG. 15 shows a rear elevational view thereof; FIG. 16 shows a top view thereof; and, FIG. 17 shows a bottom view thereof.

**1 Claim, 11 Drawing Sheets**

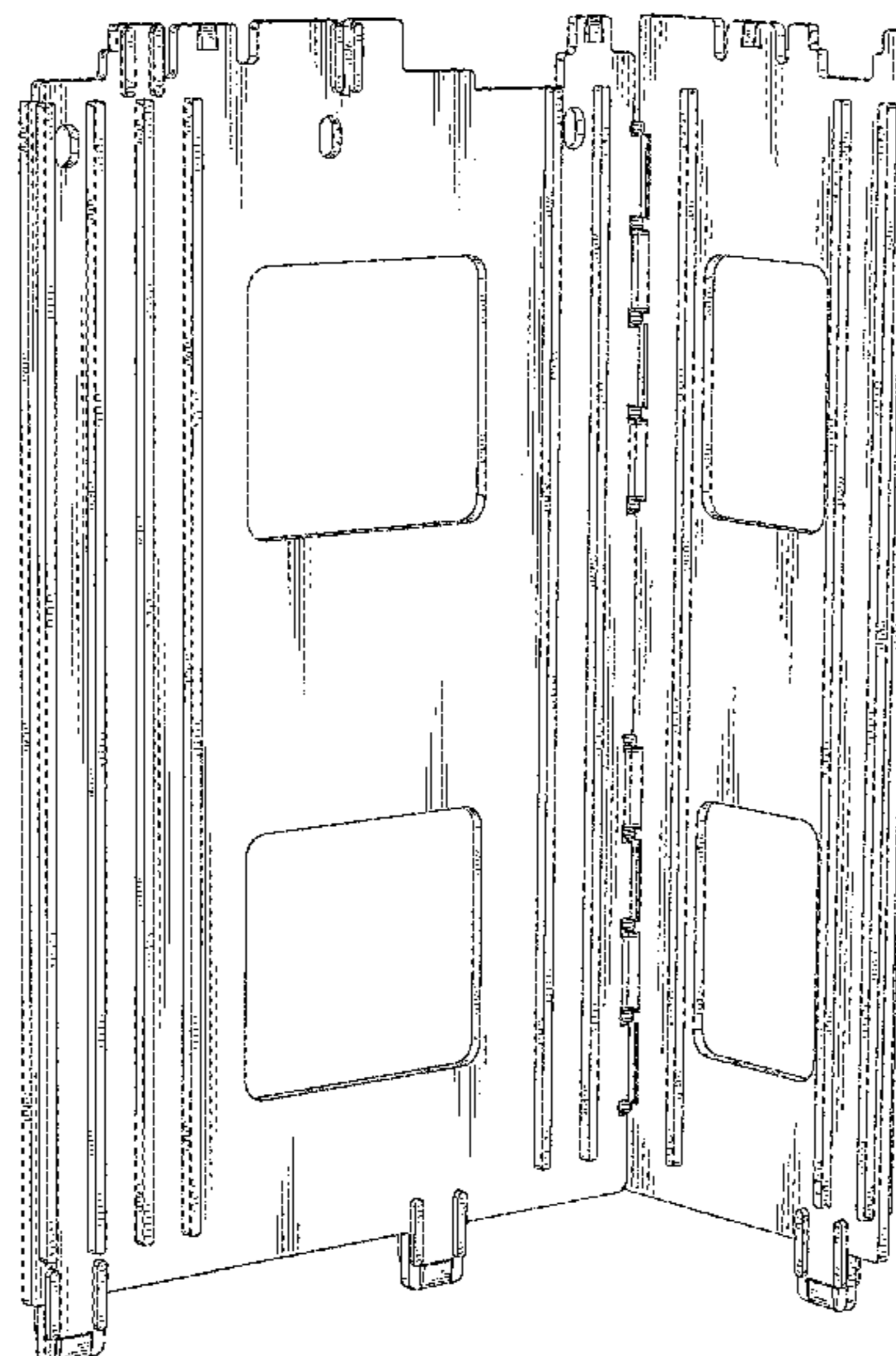

(56)

References Cited

U.S. PATENT DOCUMENTS

6,412,745 B1 \* 7/2002 Yokoyama ..... A47B 95/00  
248/247

6,474,759 B2 11/2002 Hsu

6,520,356 B2 2/2003 Miller, Jr.

6,695,418 B2 2/2004 Skov et al.

6,752,278 B2 6/2004 Craft et al.

6,764,144 B2 7/2004 Insalaco et al.

6,974,037 B2 \* 12/2005 Haney ..... A47B 88/044  
211/183

D520,265 S 5/2006 Sparkowski

D537,655 S 3/2007 Hessell

D541,558 S 5/2007 Meyer et al.

7,293,785 B2 11/2007 Bush et al.

D565,324 S 4/2008 Sparkowski

D584,538 S 1/2009 Weigand et al.

D615,777 S 5/2010 Lee et al.

D635,801 S 4/2011 Stubis

D639,586 S \* 6/2011 Selinger ..... D25/126

D644,452 S 9/2011 Naples et al.

8,079,313 B2 12/2011 Sparkowski

D657,591 S 4/2012 Sanchez

D661,524 S \* 6/2012 Watts ..... D25/119

D674,219 S \* 1/2013 Kim ..... D6/702

D674,220 S \* 1/2013 Kim ..... D6/702

D674,221 S \* 1/2013 Kim ..... D6/702

D674,682 S \* 1/2013 Shea ..... D8/373

D676,686 S 2/2013 Lim

D676,687 S 2/2013 Lim

D680,775 S \* 4/2013 Xin ..... D6/675.1

D683,160 S \* 5/2013 Williams ..... D6/675.1

D716,080 S 10/2014 Bell et al.

D718,560 S 12/2014 Denby et al.

D729,611 S \* 5/2015 Schmidt ..... D8/349

D731,823 S 6/2015 Kelinske et al.

D733,473 S \* 7/2015 Troyner ..... D6/705

D742,141 S \* 11/2015 Fitzgerald ..... D6/675.1

D743,952 S \* 11/2015 Venghaus ..... D14/238

D753,425 S \* 4/2016 Johansson ..... D25/119

D754,458 S \* 4/2016 Mason ..... D6/675.1

9,326,604 B1 \* 5/2016 Schuldt ..... A47B 96/04

2008/0061019 A1 3/2008 Lin et al.

2008/0128319 A1 6/2008 Noble Colin et al.

2009/0107939 A1 4/2009 Liao

2013/0048588 A1 2/2013 Vilkomirski et al.

2016/0051044 A1 \* 2/2016 Sabounjian ..... A47B 47/021  
211/186

2016/0165746 A1 \* 6/2016 Byargeon ..... G06F 1/16  
248/231.31

\* cited by examiner

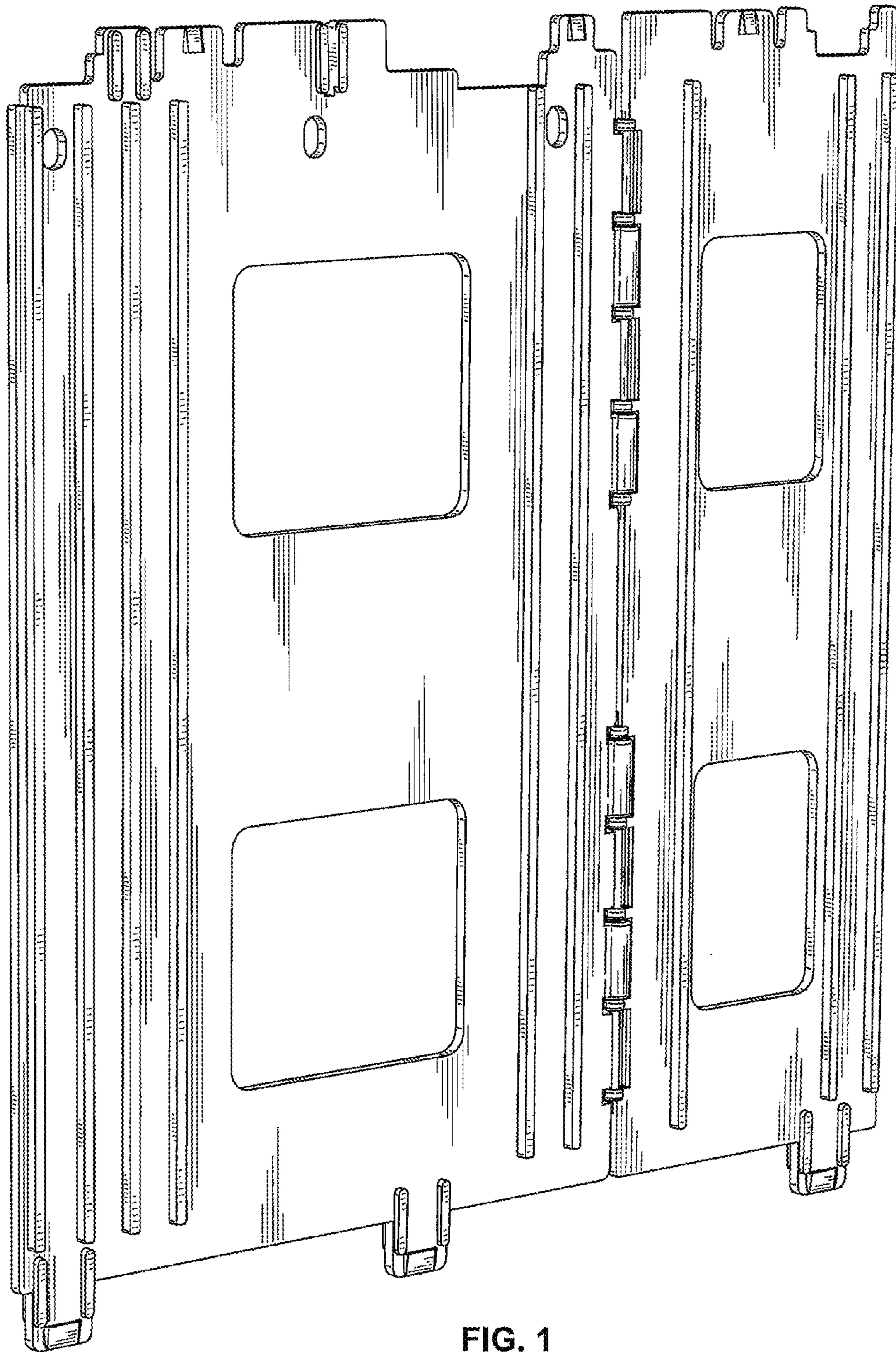

FIG. 1

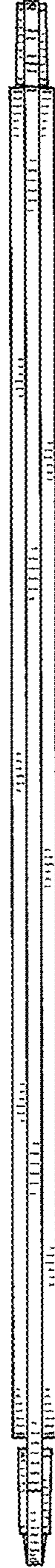

FIG. 2

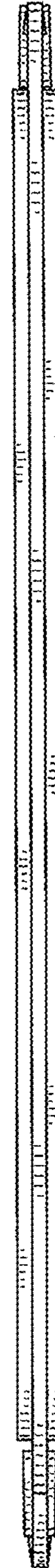

FIG. 3

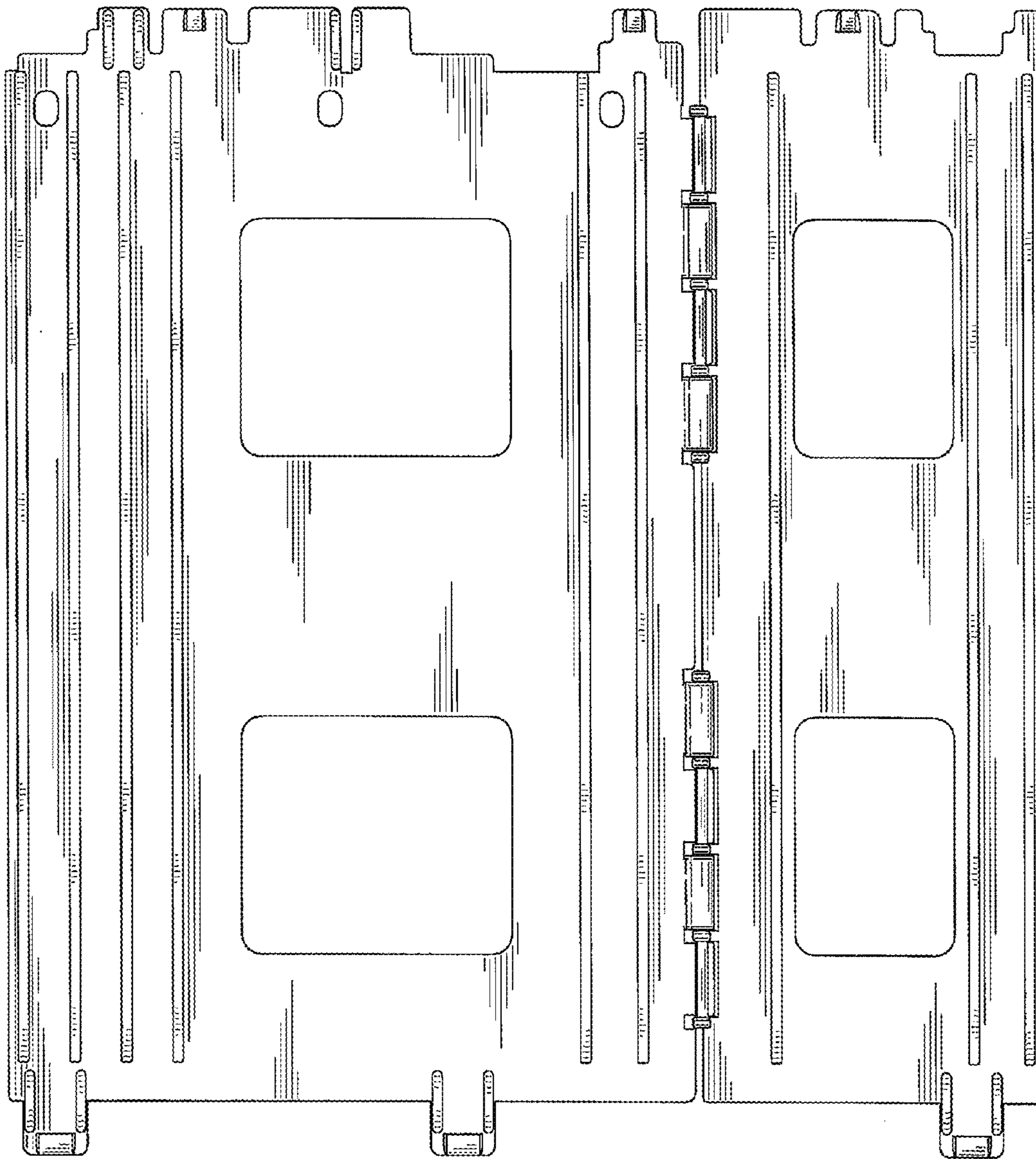

FIG. 4

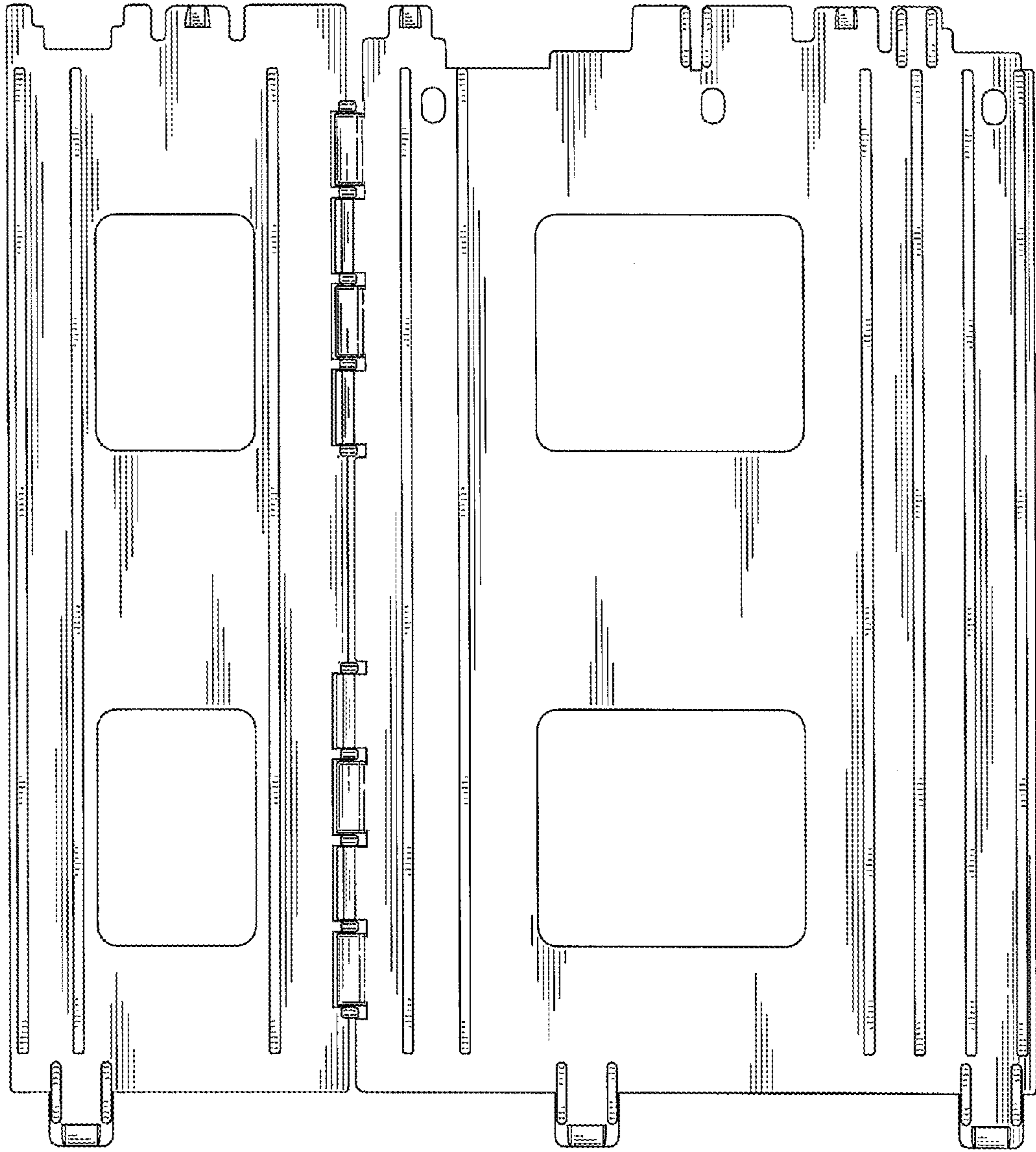

FIG. 5



FIG. 6

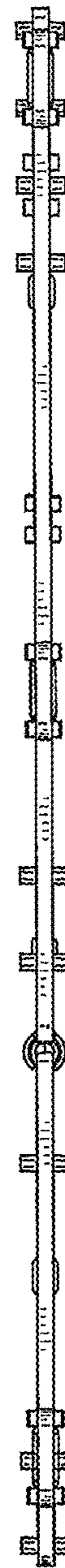

FIG. 7

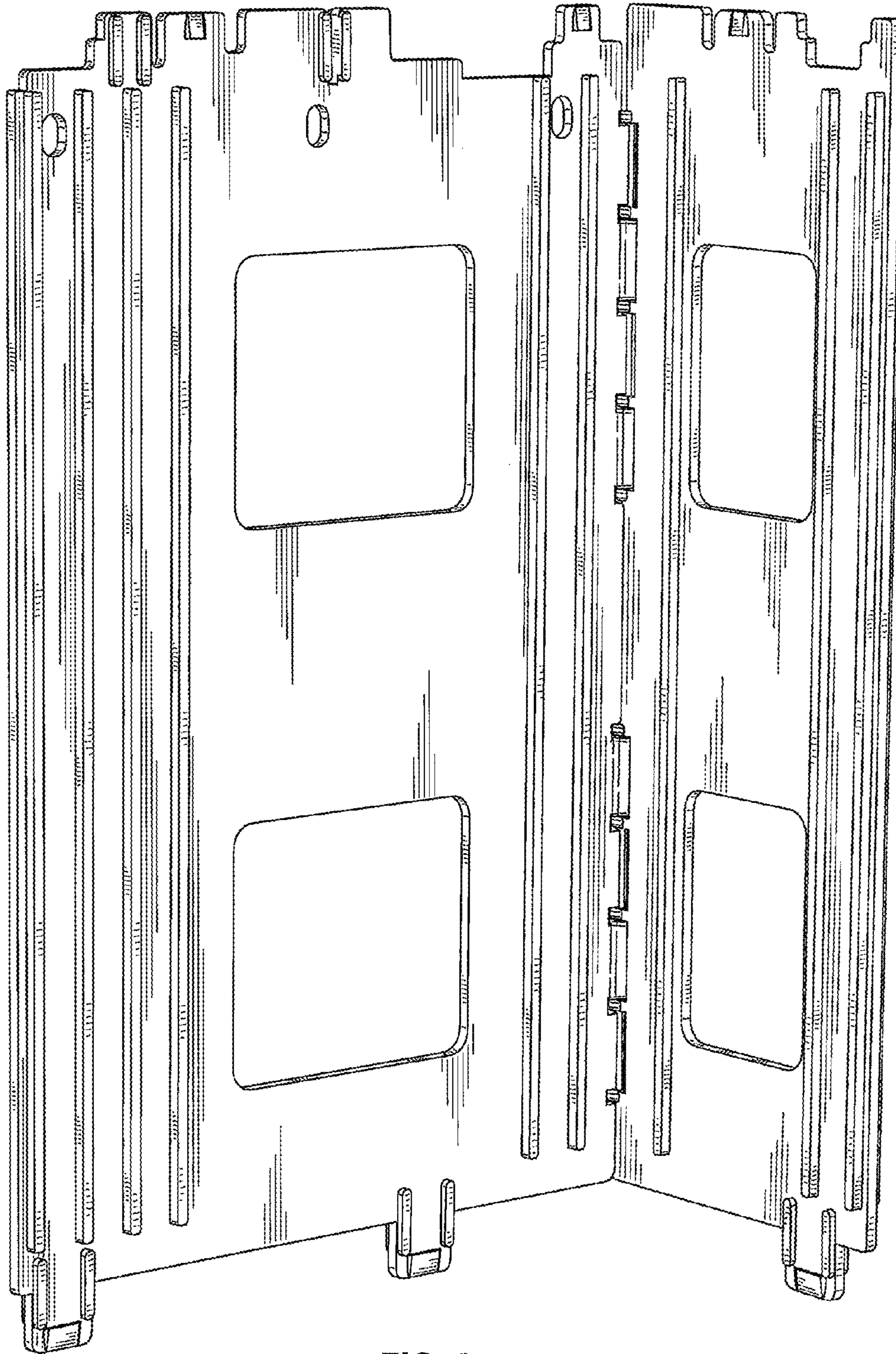

FIG. 8



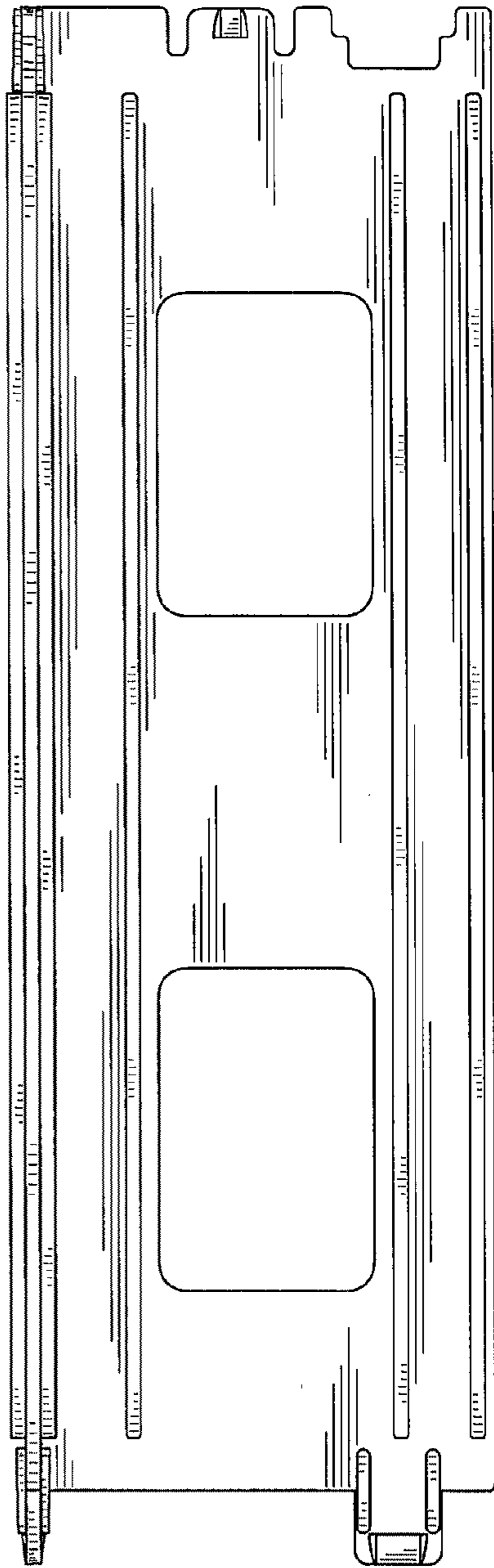

FIG. 9

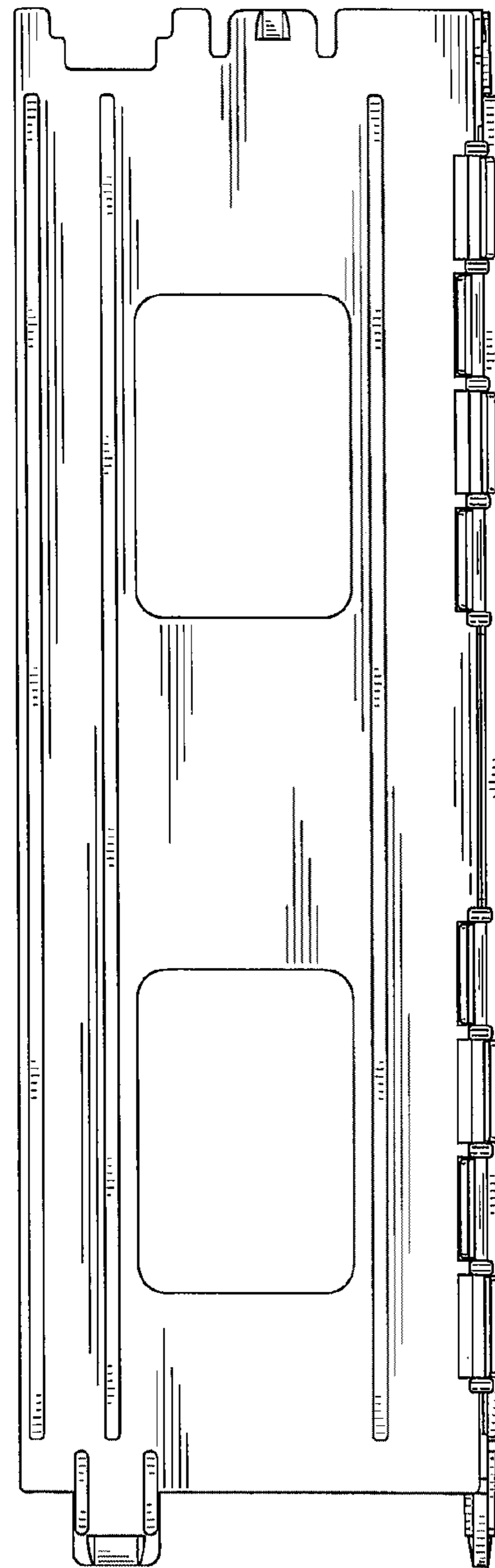

FIG. 10

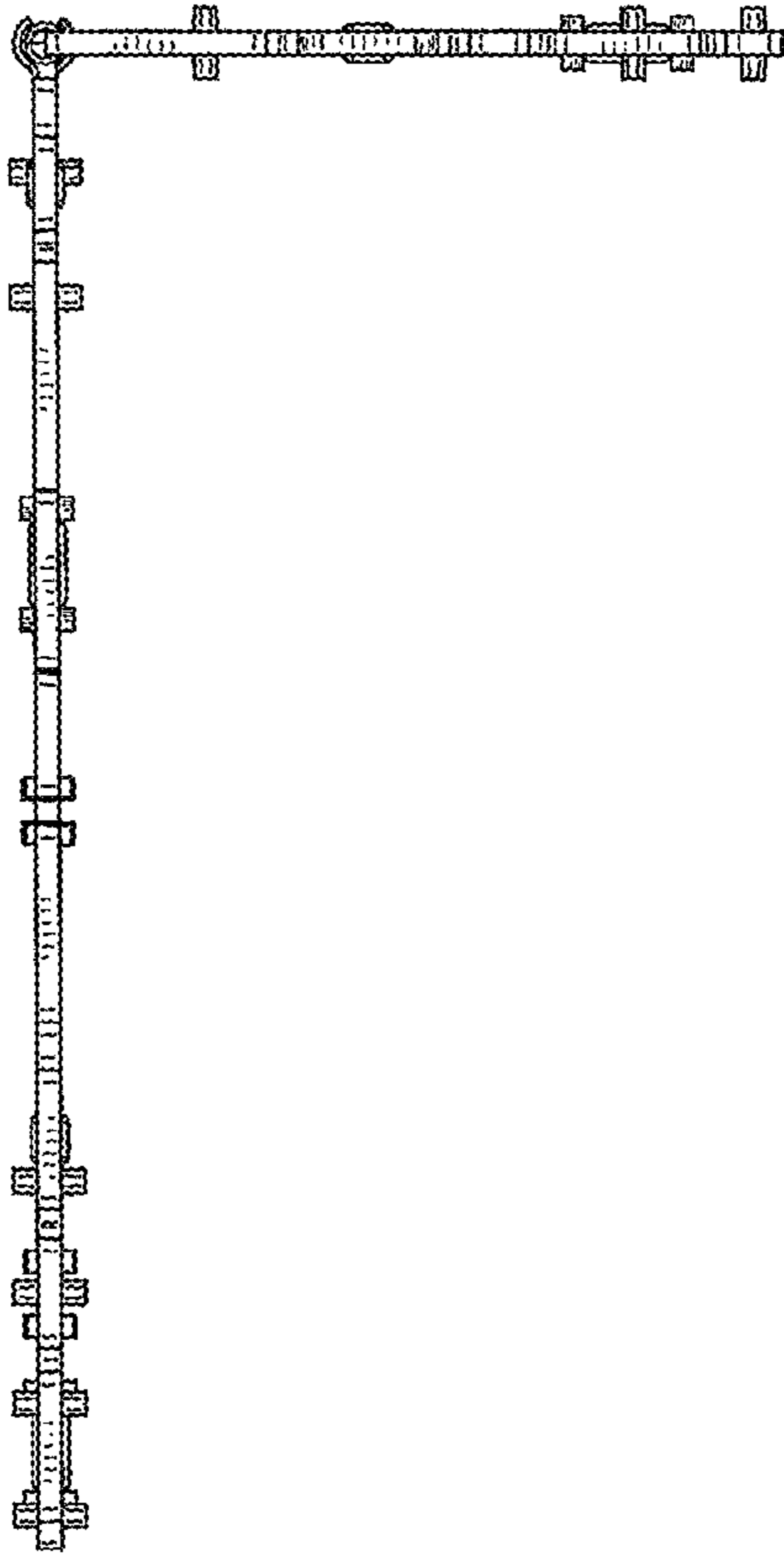

FIG. 11

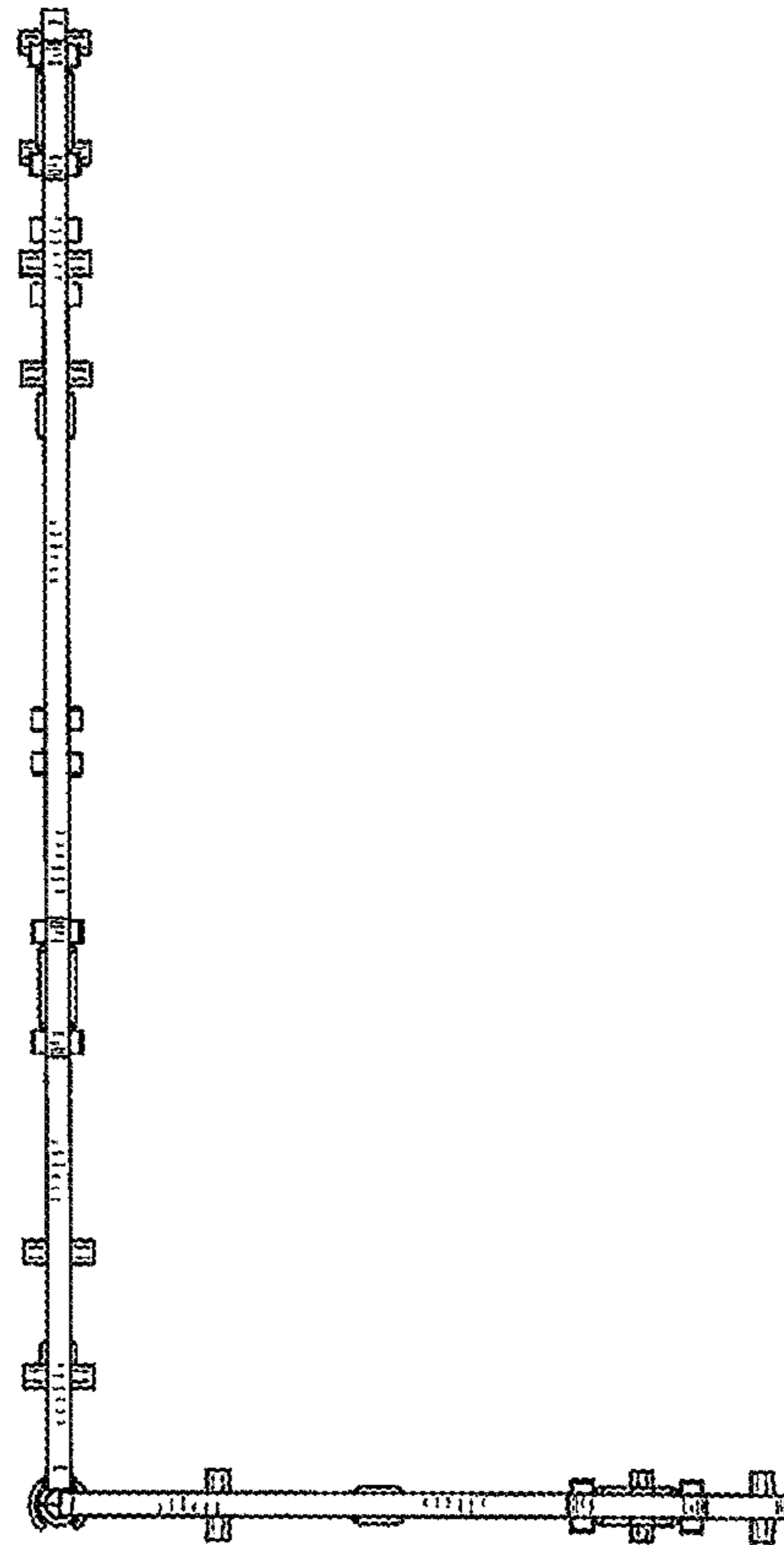

FIG. 12

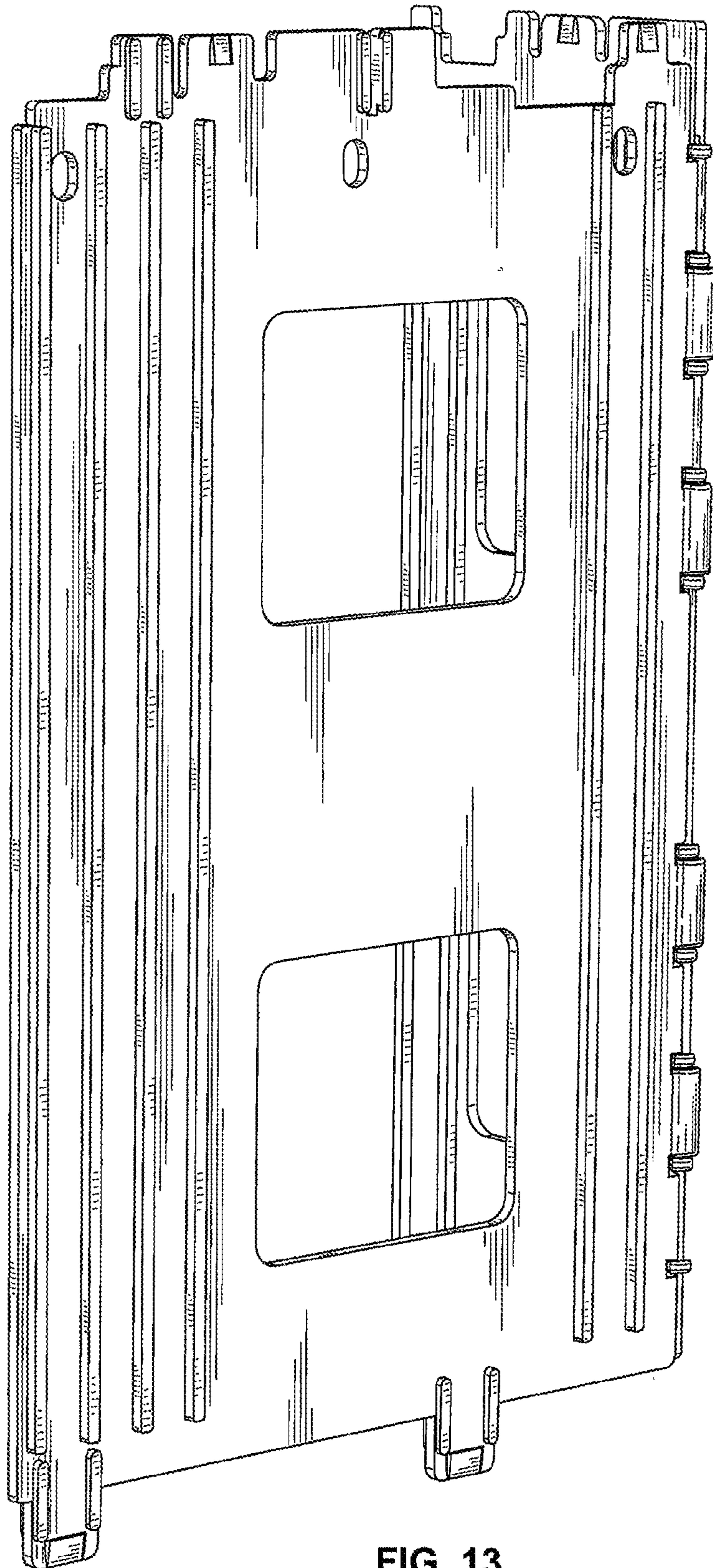

FIG. 13

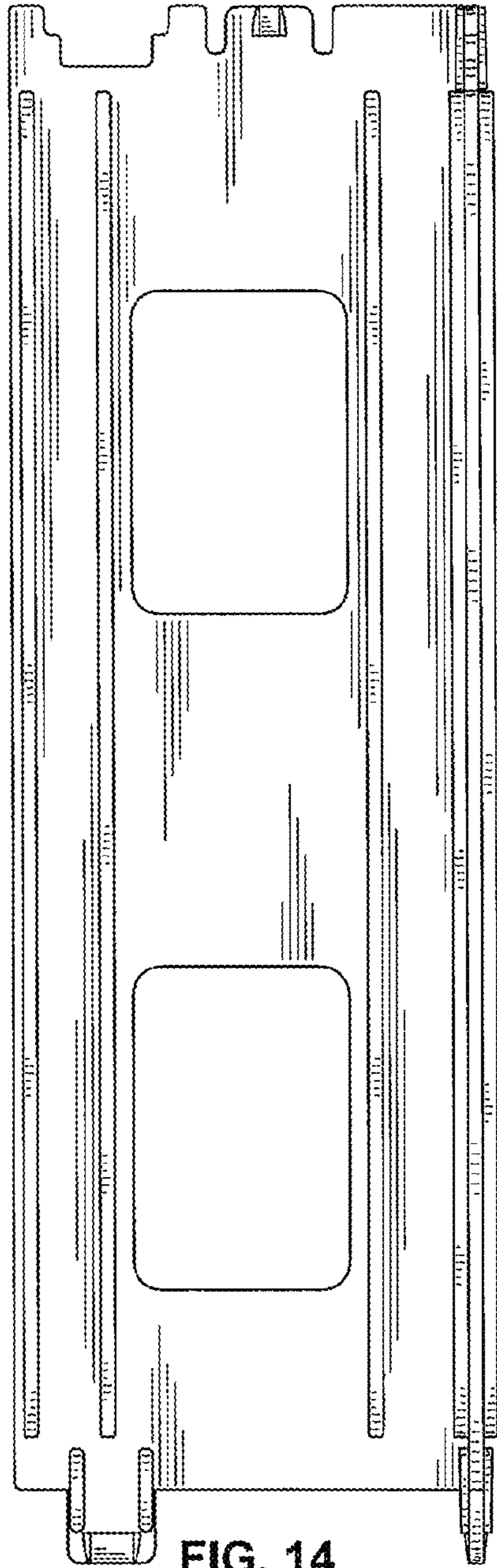

FIG. 14

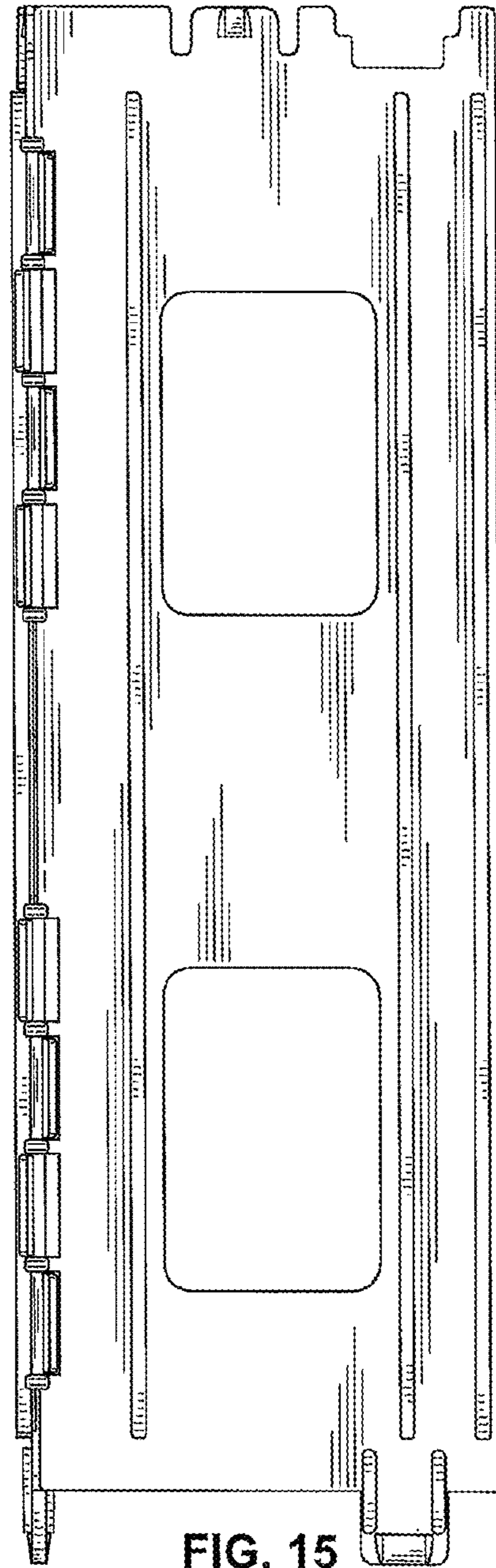

FIG. 15

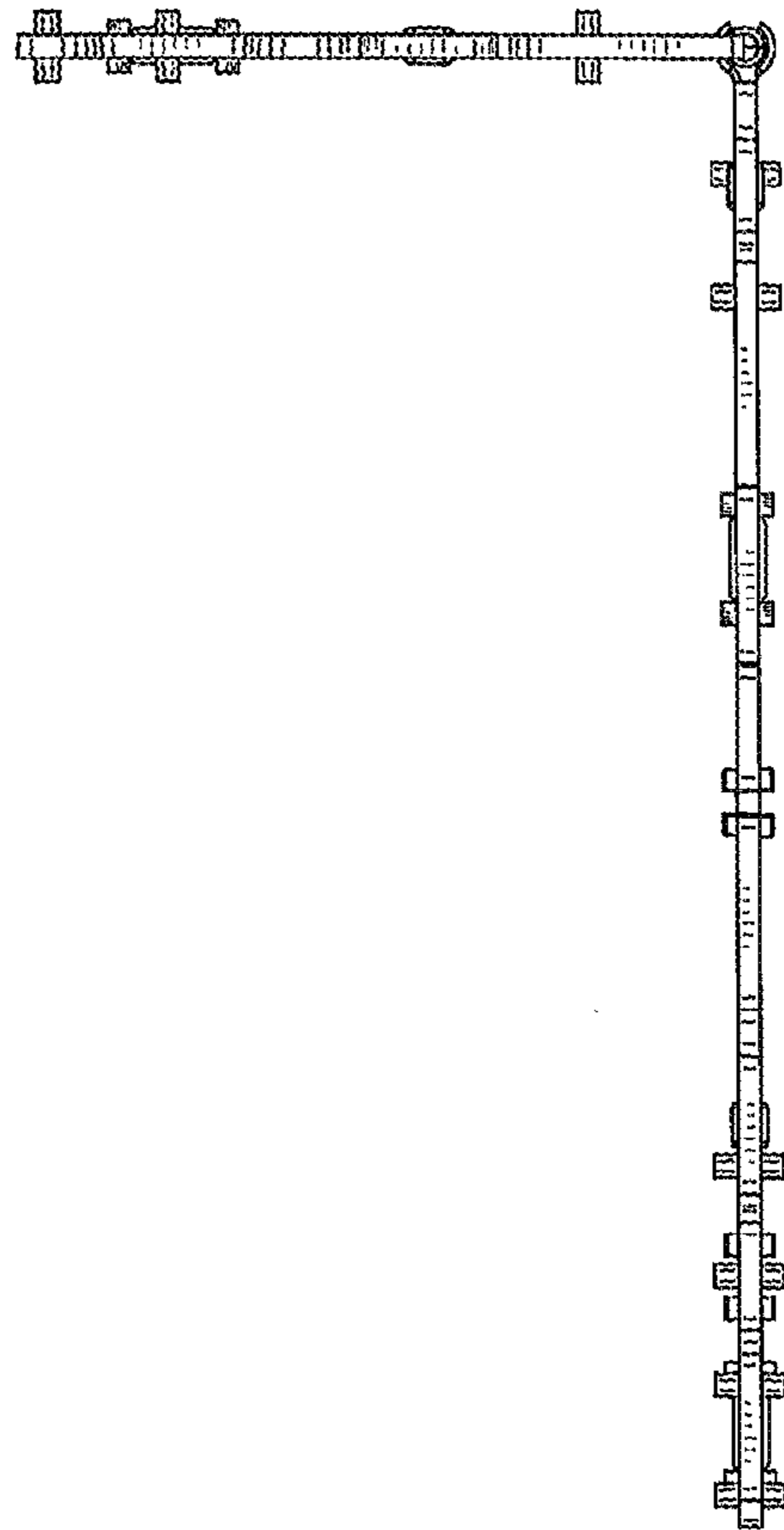

FIG. 16

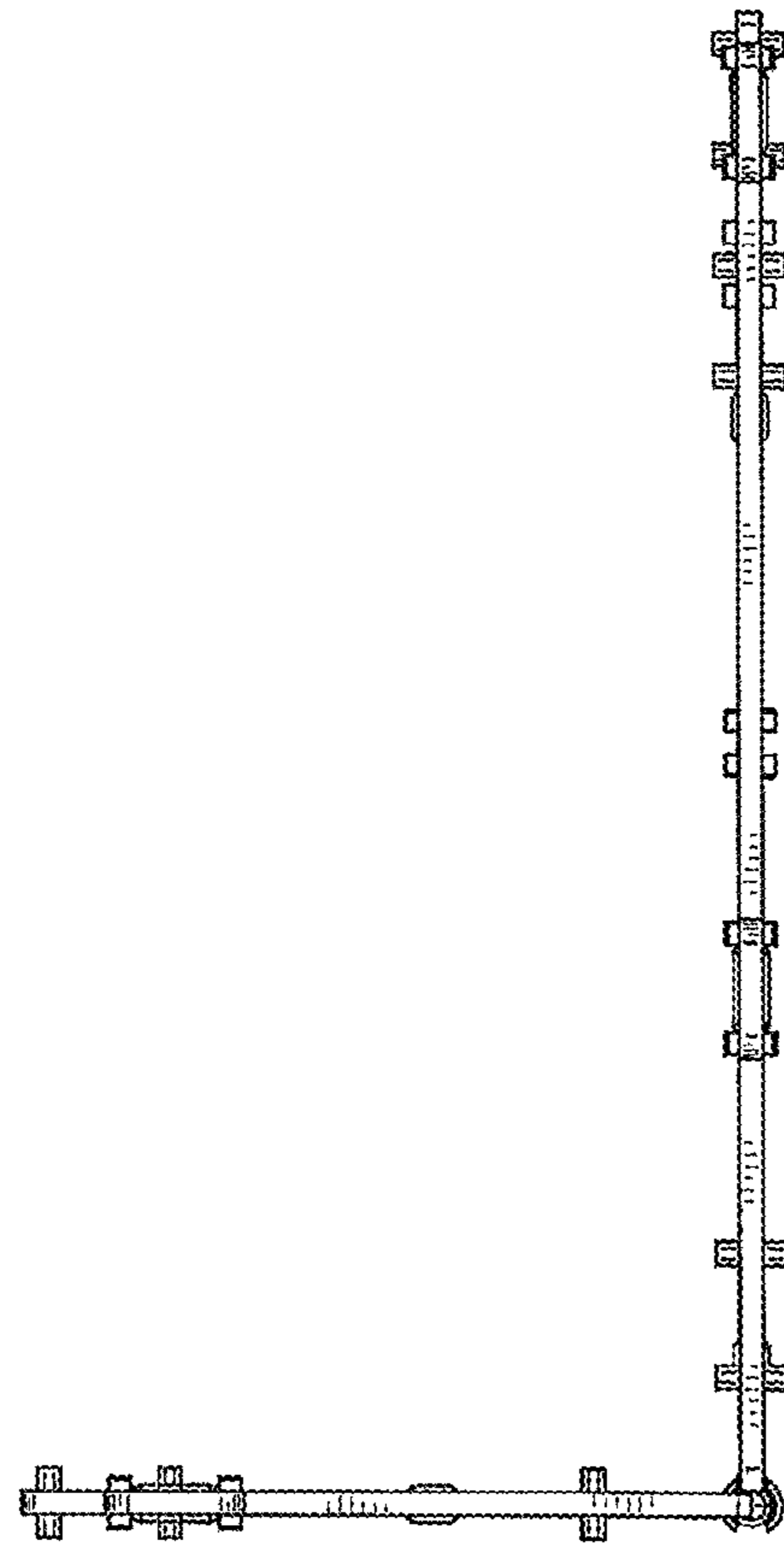

FIG. 17