



US00D771403S

(12) **United States Design Patent** (10) **Patent No.:** **US D771,403 S**  
**Matthews et al.** (45) **Date of Patent:** **\*\* Nov. 15, 2016**

(54) **HANGER CONTAINER FOR CAR FLOOR MATS**

(71) Applicant: **Who-Rae Pty Ltd**, South Melbourne (AU)

(72) Inventors: **Giles Frederick Matthews**, Hawthorn (AU); **Nathanael Andrew Hunt**, Eltham (AU); **Warwick James Brown**, North Melbourne (AU)

(73) Assignee: **Who-Rae Australia, LLC**, Compton, CA (US)

(\*\*) Term: **14 Years**

(21) Appl. No.: **29/504,831**

(22) Filed: **Oct. 9, 2014**

(30) **Foreign Application Priority Data**

Jul. 22, 2014 (AU) ..... 201413574  
Jul. 22, 2014 (AU) ..... 201413575  
Jul. 22, 2014 (AU) ..... 201413579

(51) **LOC (10) Cl.** ..... **06-04**

(52) **U.S. Cl.**  
USPC ..... **D6/513**

(58) **Field of Classification Search**  
USPC ..... D6/512, 513, 567, 323, 326; D9/415, D9/418, 722, 455  
CPC .... B65D 85/68; B65D 85/18; B65D 43/162; B65D 43/163; B42F 7/10; F16B 45/00  
See application file for complete search history.

(56) **References Cited**

**U.S. PATENT DOCUMENTS**

1,786,923 A \* 12/1930 Scruby ..... A47G 25/26  
223/88  
2,855,649 A \* 10/1958 Kanter ..... A47G 25/743  
206/292

D213,237 S \* 1/1969 Bassett et al. .... D6/315  
3,841,478 A \* 10/1974 Wells ..... B65D 33/14  
206/335  
3,862,687 A \* 1/1975 Pirman ..... B65D 73/0071  
206/289  
3,899,078 A \* 8/1975 Ambrozetes ..... B65D 85/18  
206/278  
3,987,958 A \* 10/1976 Kamins ..... B65D 33/1683  
383/15  
4,011,946 A \* 3/1977 Savage ..... G09F 5/00  
206/284  
4,190,151 A \* 2/1980 Russell ..... B65D 73/0071  
206/281  
D262,852 S \* 2/1982 Wallenwein ..... D6/315  
D272,494 S \* 2/1984 Mahowald ..... D6/513  
4,559,738 A \* 12/1985 Helfman ..... E04B 2/74  
47/67

(Continued)

*Primary Examiner* — John Windmuller

*Assistant Examiner* — Steven Czyz

(74) *Attorney, Agent, or Firm* — Wood Herron & Evans LLP

(57) **CLAIM**

We claim the ornamental design for a hanger container for car floor mats, as shown and described.

**DESCRIPTION**

FIG. 1 is a front view of our new design for a hanger container for car floor mats;  
FIG. 2 is a rear view thereof;  
FIG. 3 is a right side view thereof;  
FIG. 4 is a top view thereof;  
FIG. 5 is a bottom view thereof;  
FIG. 6 is a front perspective view thereof; and,  
FIG. 7 is a rear perspective view thereof.  
The broken dash lines shown in the drawing views represent non-claimed subject matter, and neither the lines themselves nor anything within the lines form any part of the claimed invention.

**1 Claim, 6 Drawing Sheets**

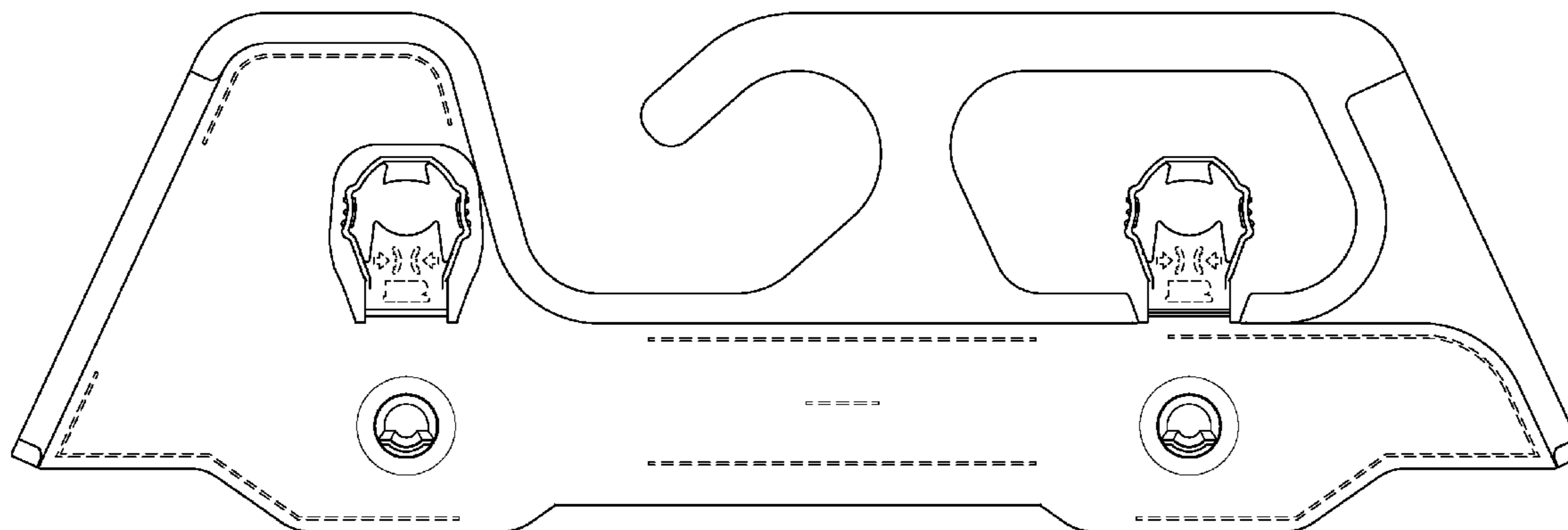

(56)

References Cited

U.S. PATENT DOCUMENTS

D285,148 S *	8/1986	Kester .....	D6/317	7,753,241 B2 *	7/2010	Masanek, Jr. ....	A47F 5/0006 211/113
D287,085 S *	12/1986	Leeds .....	D6/327	D625,935 S *	10/2010	Theisen .....	D20/43
4,856,654 A *	8/1989	Reuben .....	B60N 3/04 206/449	D633,310 S *	3/2011	Song .....	D6/315
D326,613 S *	6/1992	Babcock .....	294/137	8,720,842 B2 *	5/2014	Huang .....	A47F 7/16 211/113
5,152,404 A *	10/1992	Salrin .....	A47F 5/0807 211/46	D715,635 S *	10/2014	Brown .....	D9/415
5,297,706 A *	3/1994	Blitz .....	A47G 25/485 223/91	D719,363 S *	12/2014	Marks .....	D6/318
D345,908 S *	4/1994	Wallach .....	D3/293	D737,676 S *	9/2015	Brown .....	D9/415
5,595,300 A *	1/1997	Paik .....	B65D 25/22 206/449	2007/0145085 A1 *	6/2007	Masanek .....	A47F 5/0006 223/96
D430,030 S *	8/2000	DuCorday .....	D9/443	2010/0089933 A1 *	4/2010	Branger .....	B65D 25/22 220/751
D483,595 S *	12/2003	Trapp .....	D6/574	2011/0095155 A1 *	4/2011	Milella, Jr. ....	A47F 5/0006 248/339
D525,661 S *	7/2006	Hussaini .....	D20/43	2014/0202901 A1 *	7/2014	Brown .....	B65D 85/54 206/335
D559,103 S *	1/2008	Van Handel .....	D9/415	2014/0203015 A1 *	7/2014	Brown .....	B65D 73/0021 220/4.22
D584,770 S *	1/2009	Bizzell .....	D19/26				

\* cited by examiner

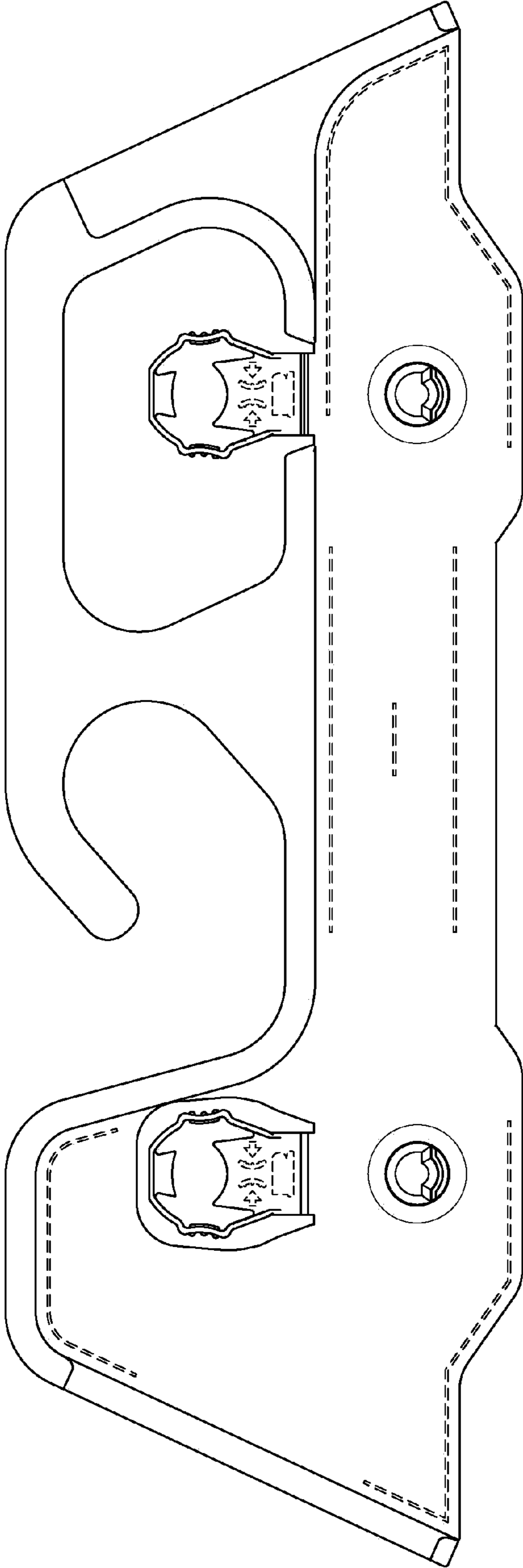

FIG. 1

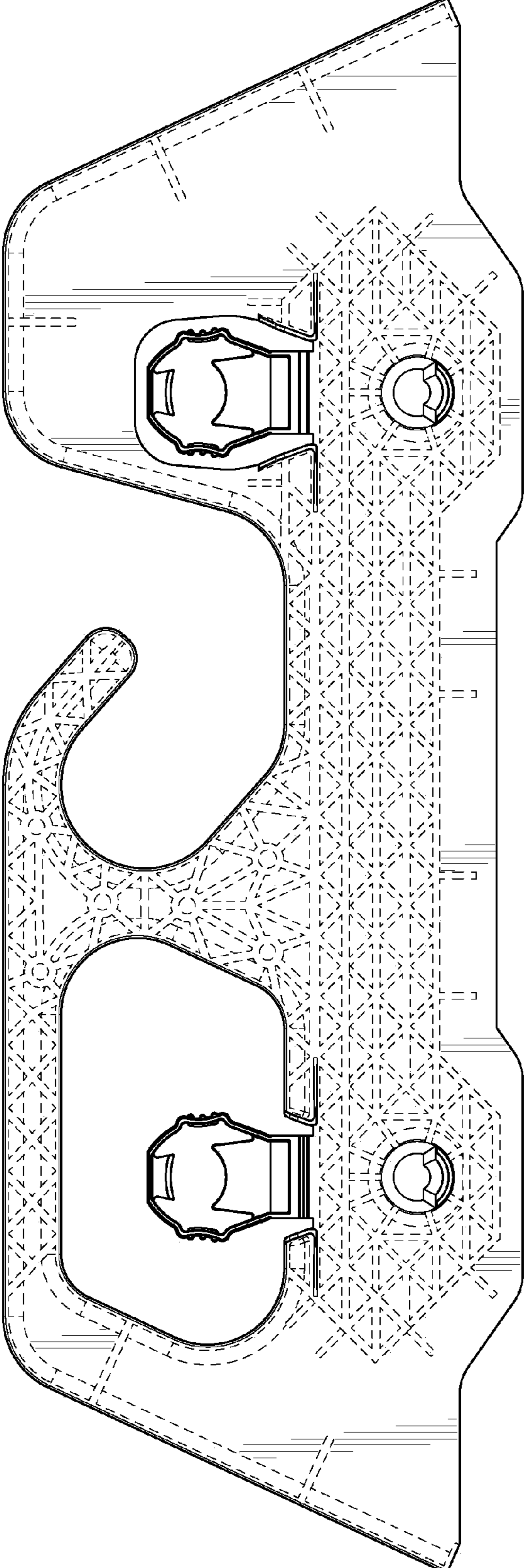

FIG. 2

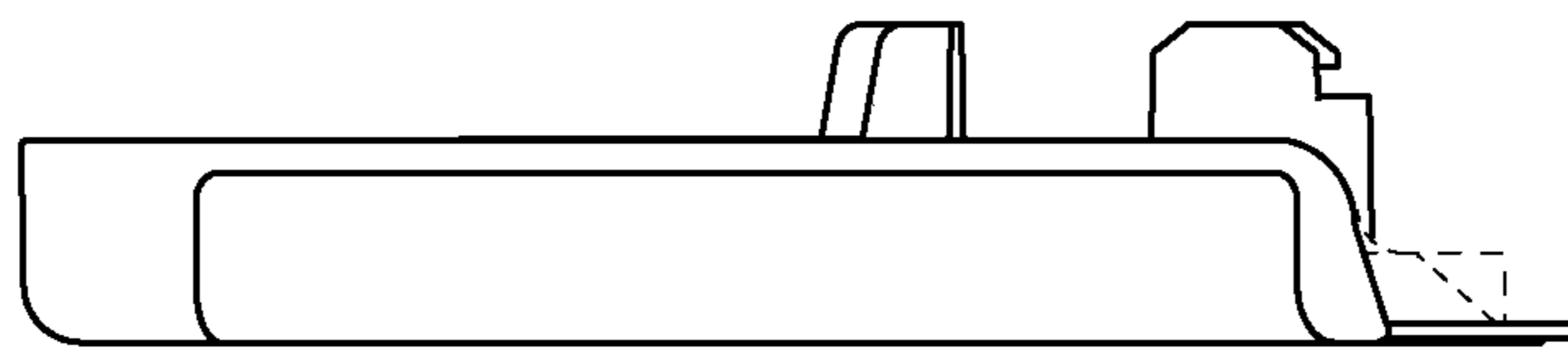

FIG. 3

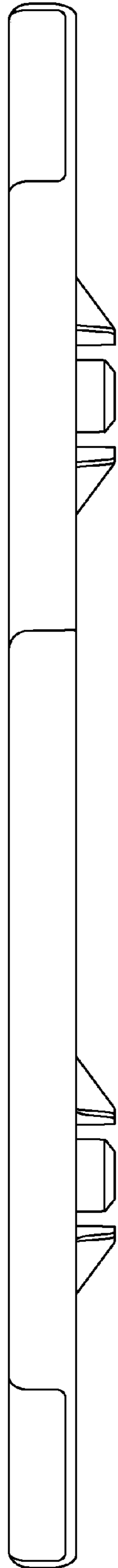

FIG. 4

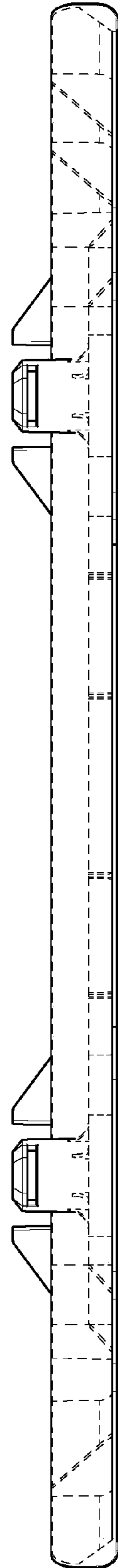

FIG. 5



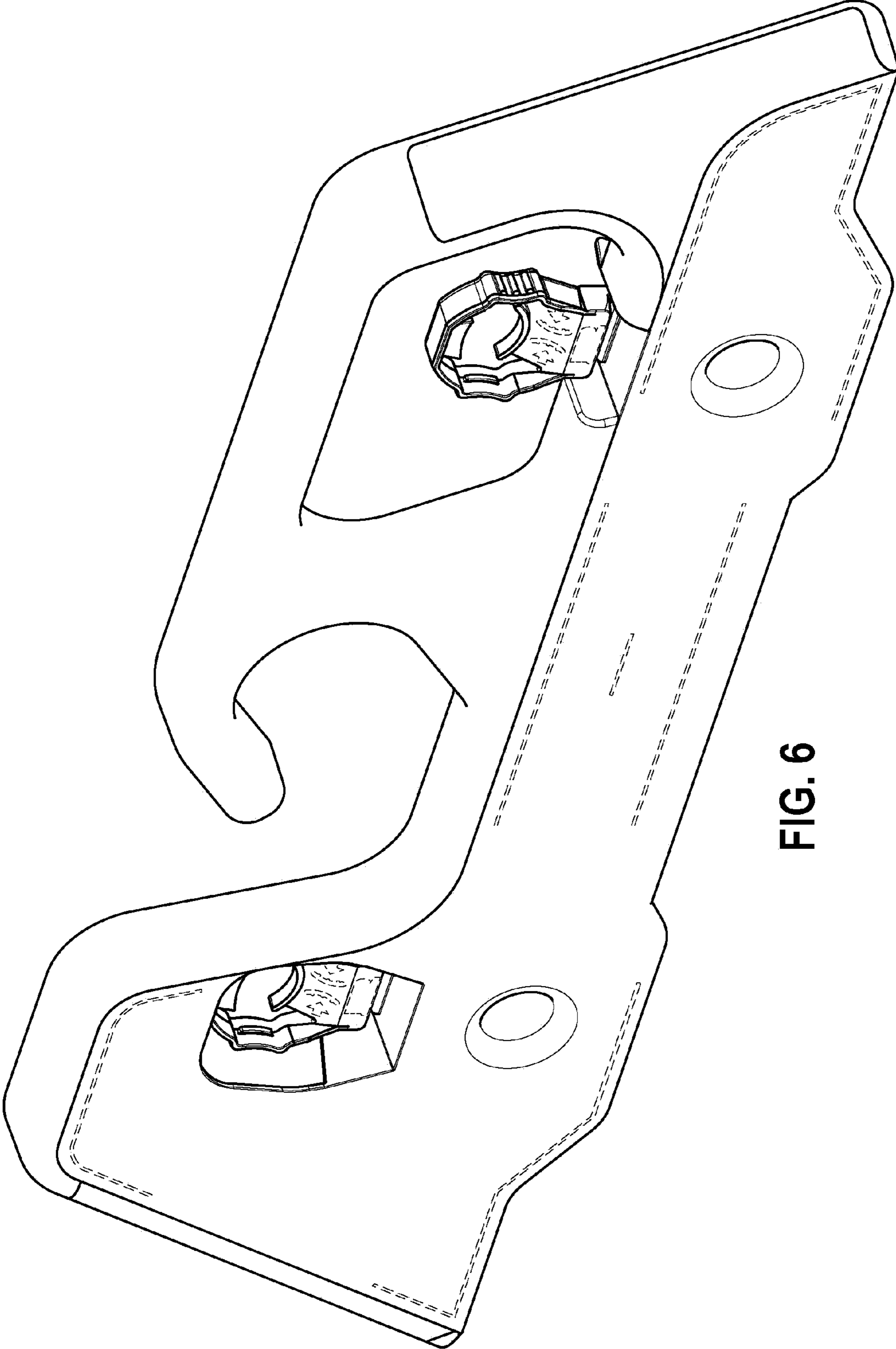

FIG. 6

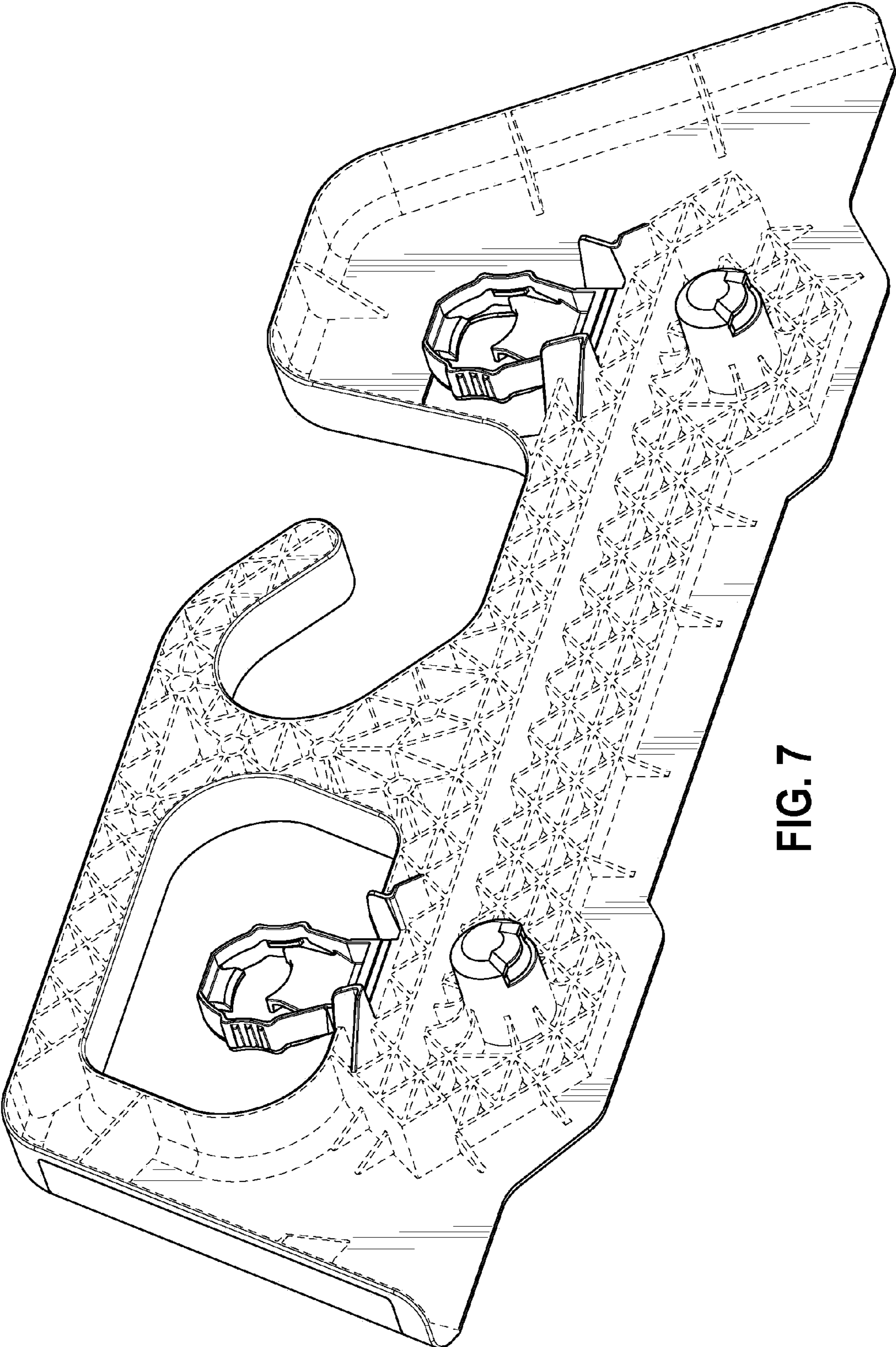

FIG. 7