



US00D771383S

(12) **United States Design Patent**  
**Vincent**

(10) **Patent No.:** **US D771,383 S**

(45) **Date of Patent:** **\*\* Nov. 15, 2016**

(54) **CRATE**

(71) Applicant: **Vasile Vincent**, Clawson, MI (US)

(72) Inventor: **Vasile Vincent**, Clawson, MI (US)

(\*\*) Term: **15 Years**

(21) Appl. No.: **29/530,319**

(22) Filed: **Jun. 16, 2015**

(51) **LOC (10) Cl.** ..... **03-01**

(52) **U.S. Cl.**  
USPC ..... **D3/310**

(58) **Field of Classification Search**  
USPC ..... D3/304, 308, 309, 310, 313, 314, 315;  
D6/672-673, 675, 657; D19/75, 81, 86  
CPC ... A47G 23/0241; B65D 1/22; B65D 5/0085  
See application file for complete search history.

(56) **References Cited**

U.S. PATENT DOCUMENTS

- 4,043,678 A \* 8/1977 Farrell ..... B01L 3/502  
250/576
- 4,895,267 A \* 1/1990 Karlsson ..... B42F 17/02  
220/4.28

- D372,146 S \* 7/1996 Svec ..... D19/85
- D555,736 S \* 11/2007 Decarlo ..... D19/90
- D624,660 S \* 9/2010 Himmelsbach ..... D24/230
- D655,016 S \* 2/2012 Laudo ..... D24/224
- D690,109 S \* 9/2013 Shupp ..... D3/309
- 2009/0117005 A1 \* 5/2009 Rousseau ..... B01L 3/50855  
422/64

\* cited by examiner

*Primary Examiner* — Kelley Donnelly

(74) *Attorney, Agent, or Firm* — The Dobrusin Law Firm, PC

(57) **CLAIM**

The ornamental design for a crate, as shown and described.

**DESCRIPTION**

FIG. 1 is a perspective view of the present invention.  
 FIG. 2 is a front elevational view thereof.  
 FIG. 3 is a bottom-up view thereof.  
 FIG. 4 is a side profile view thereof.  
 FIG. 5 is an opposing side profile view thereof.  
 FIG. 6 is a rear elevational view thereof; and,  
 FIG. 7 is a top down view thereof.  
 The broken lines showing environment in the drawings are for illustrative purposes only and form no part of the claimed design.

**1 Claim, 4 Drawing Sheets**

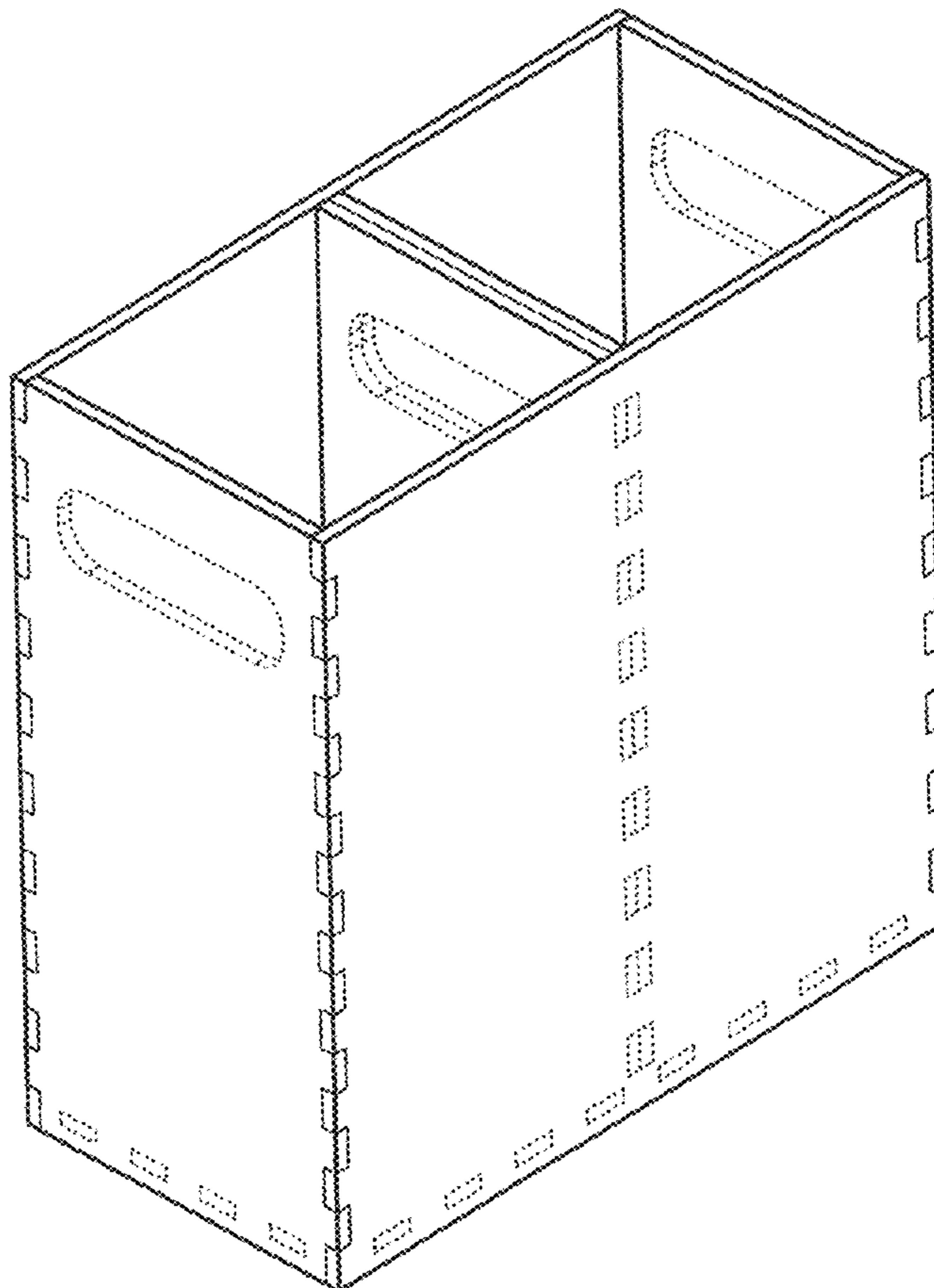

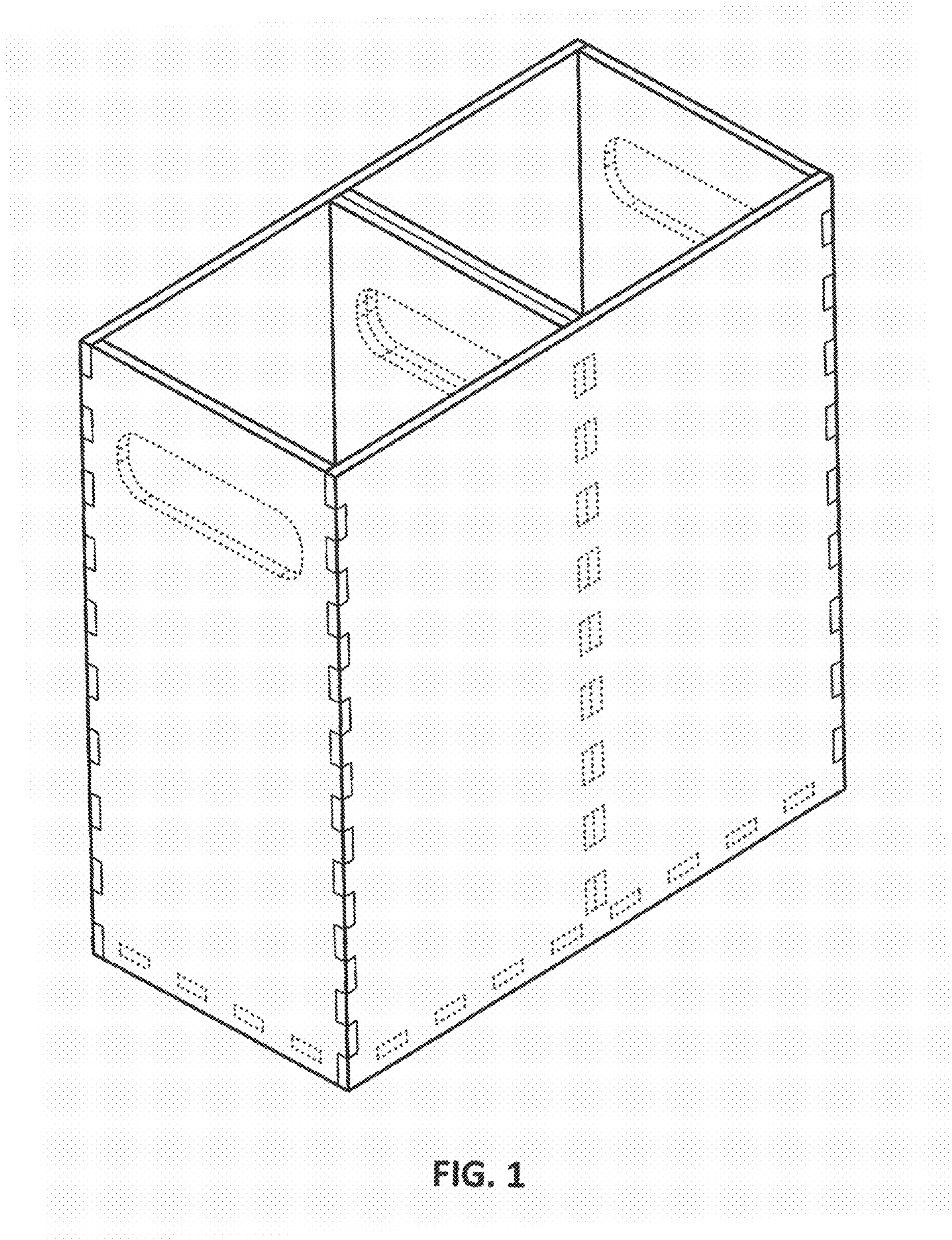

FIG. 1

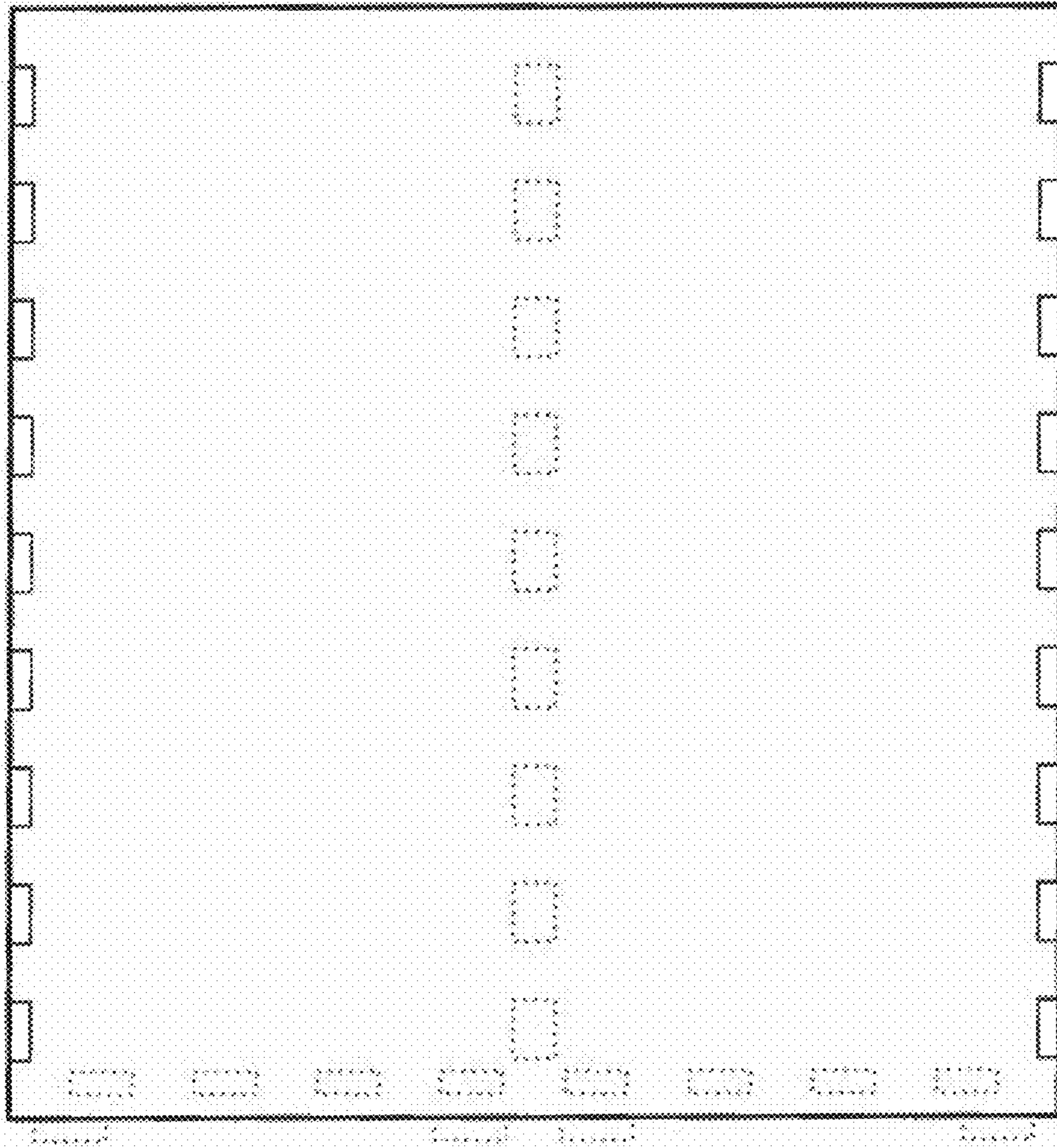

FIG. 2

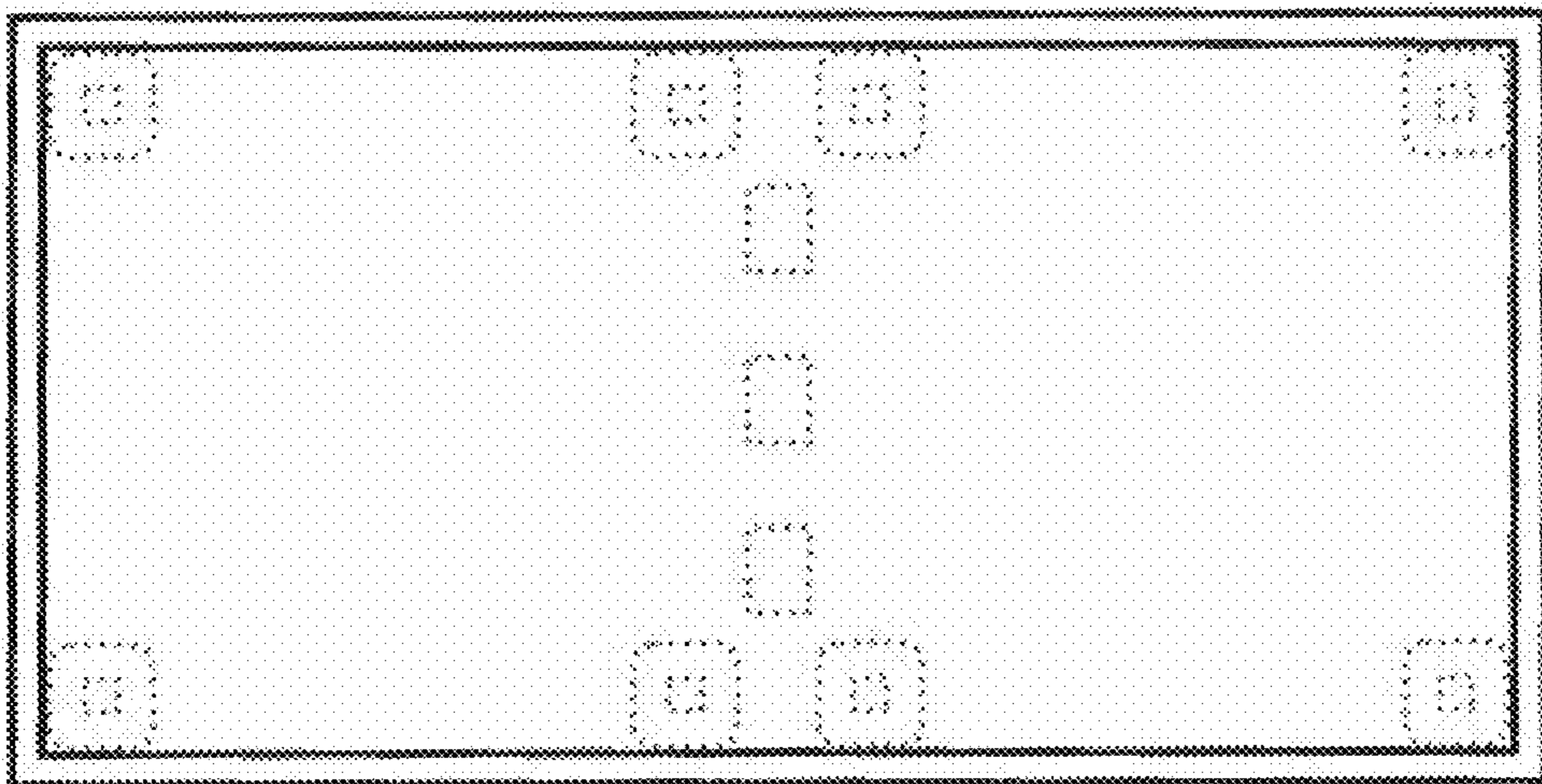

FIG. 3

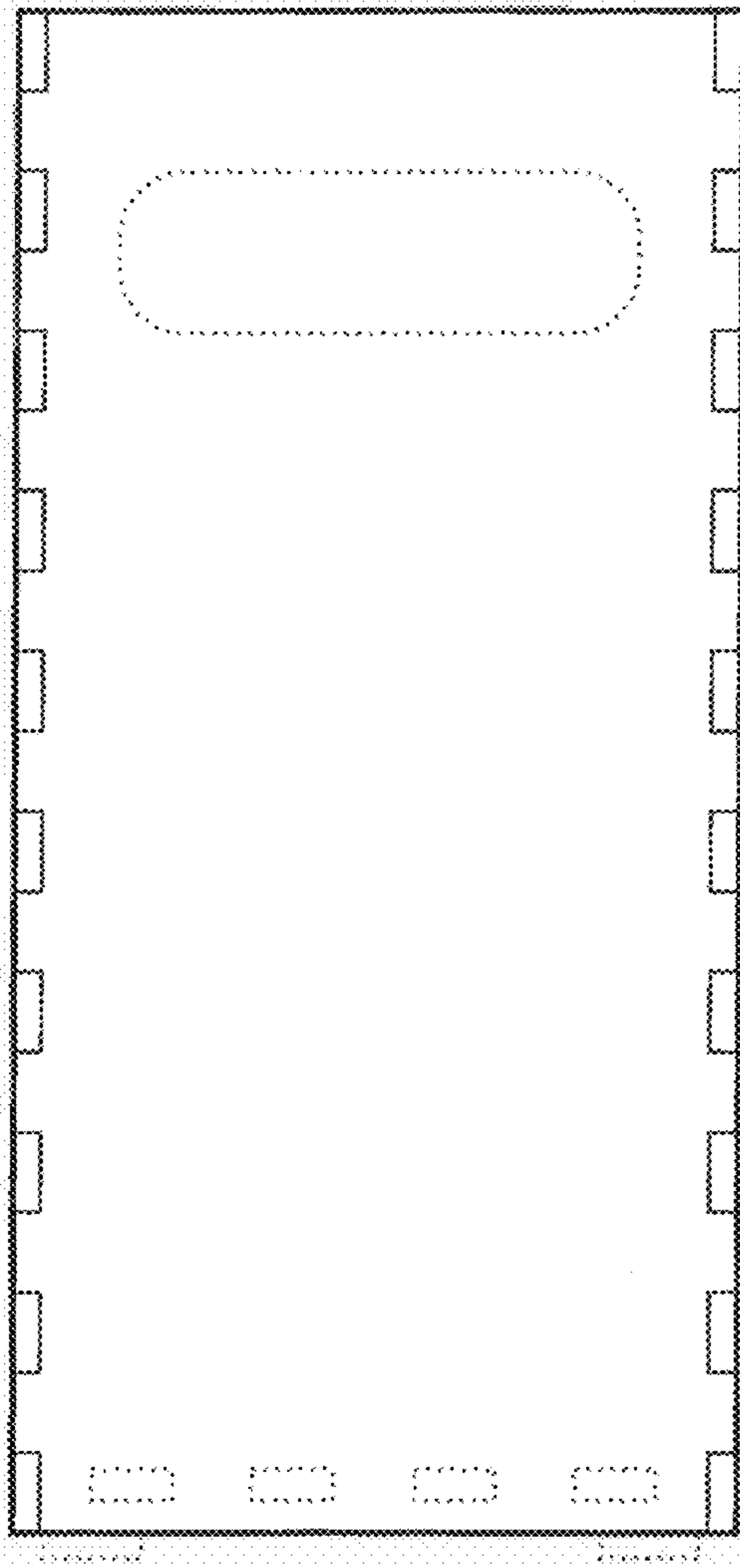

FIG. 4

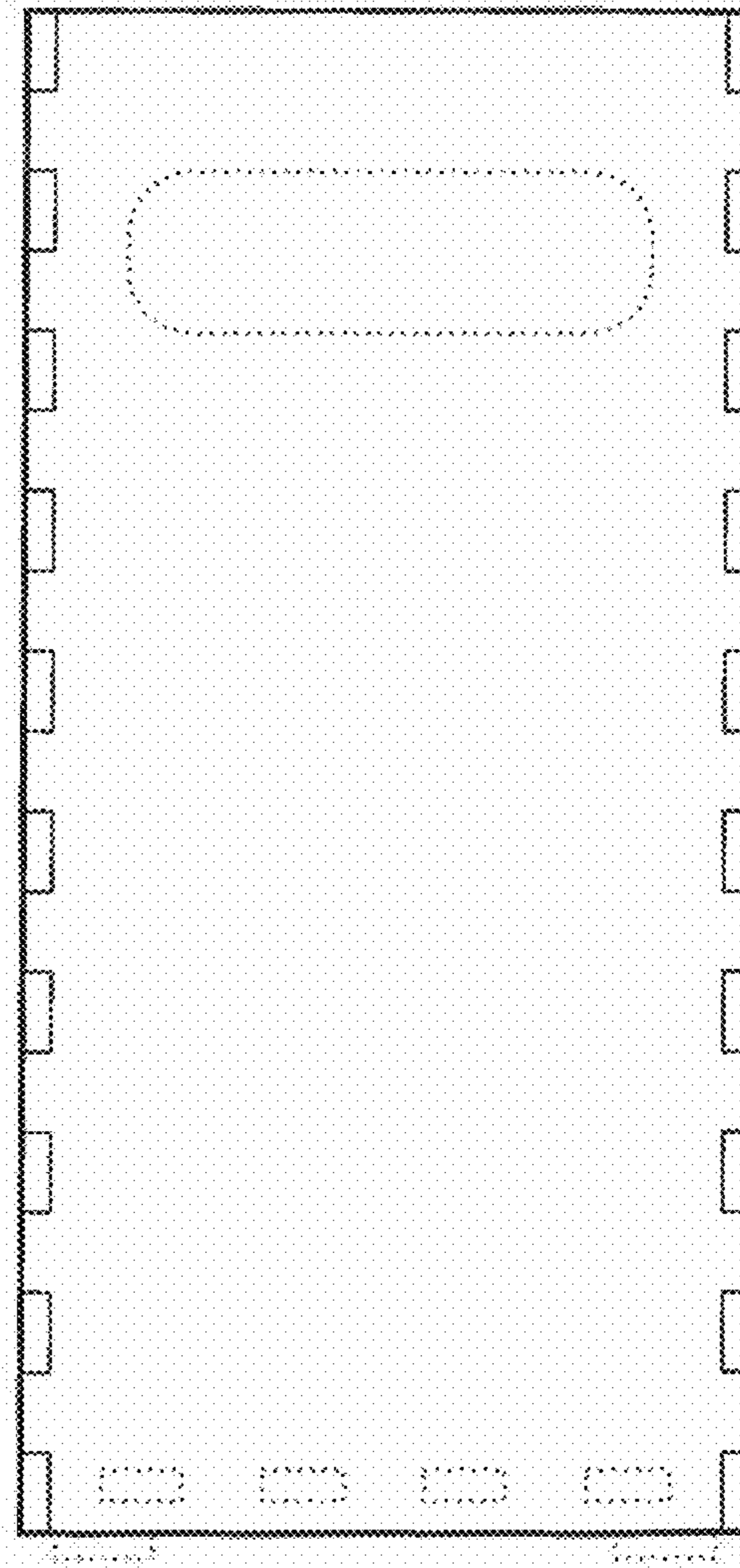

FIG. 5

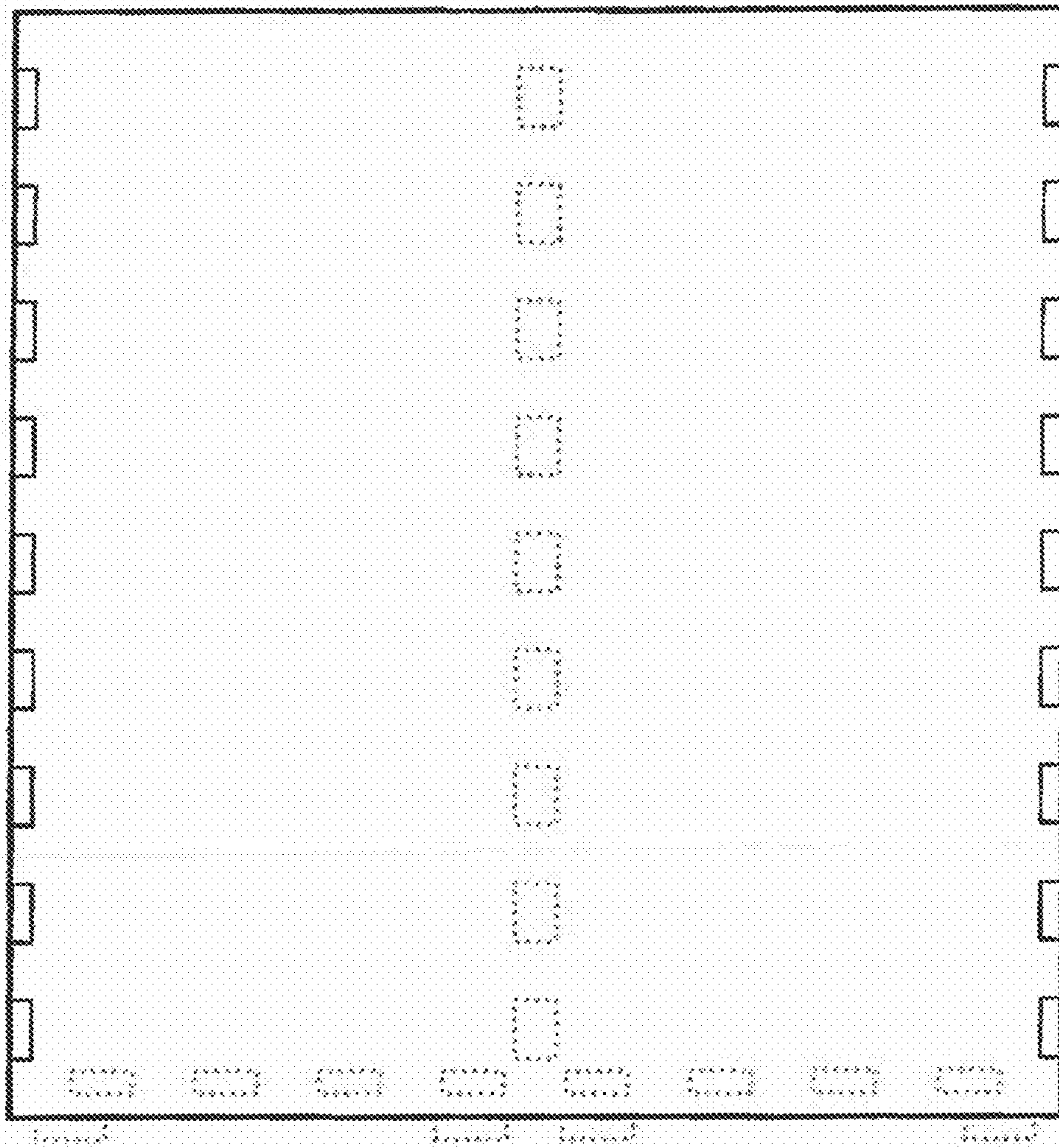

FIG. 6

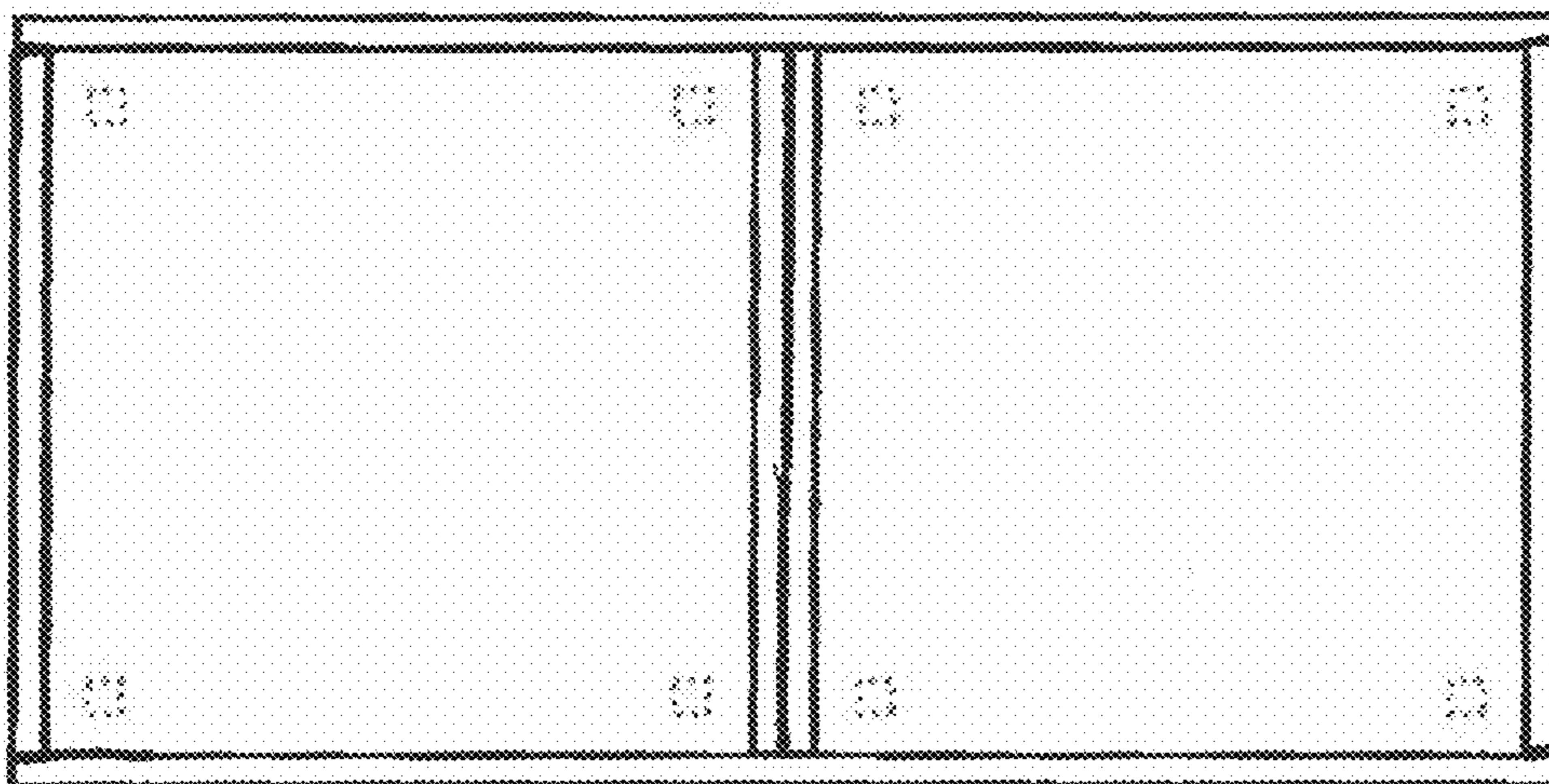

FIG. 7