



US00D771313S

(12) **United States Design Patent**
Oguchi

(10) **Patent No.:** **US D771,313 S**

(45) **Date of Patent:** **** Nov. 8, 2016**

(54) **ELECTRIC HAIR REMOVAL DEVICE**

(71) Applicant: **Yoko Oguchi**, Yokohama (JP)

(72) Inventor: **Yoko Oguchi**, Yokohama (JP)

(73) Assignee: **405 Limited Company (Shenzhen)**,
Shenzhen (CN)

(**) Term: **14 Years**

(21) Appl. No.: **29/481,555**

(22) Filed: **Feb. 7, 2014**

(51) **LOC (10) Cl.** **28-03**

(52) **U.S. Cl.**
USPC **D28/49**; D28/44

(58) **Field of Classification Search**
USPC D28/44, 44.1, 49, 51, 53, 58, 59
CPC B26B 19/00–19/107; A45D
2026/008–2026/0095; A45D
26/0042–26/0052; A45D 26/0057; A45D
26/0061; A45D 26/0004; A45D 26/0023;
A45D 26/0028; A45D 26/0033; A45D
26/0038; A45D 2200/1054; A61B 17/54
See application file for complete search history.

(56) **References Cited**

U.S. PATENT DOCUMENTS

D269,641 S *	7/1983	Mann	D28/51
D286,453 S *	10/1986	Camens	D28/49
D341,907 S *	11/1993	Ullmann	D28/49
D391,022 S *	2/1998	Ullman	D28/49
D611,198 S *	3/2010	Platek	D28/44.1
D662,660 S *	6/2012	Byun	D28/44.1
2008/0313909 A1 *	12/2008	Haczek	A45D 26/0023 30/34.1
2009/0172948 A1 *	7/2009	Kitamura	A45D 27/46 30/41.6
2010/0331795 A1 *	12/2010	Jung	A45D 26/0061 604/290
2013/0053869 A1 *	2/2013	Shekalim	A45D 26/0057 606/133

* cited by examiner

Primary Examiner — Jennifer Rivard

(74) *Attorney, Agent, or Firm* — Minder Law Group;
Willy H. Wong

(57) **CLAIM**

The ornamental design for an electric hair removal device,
as shown and described.

DESCRIPTION

FIG. 1 is a perspective view of an electric hair removal device with a cap in accordance with the present invention; FIG. 2 is a front view thereof; FIG. 3 is a rear view thereof; FIG. 4 is a right side view thereof; FIG. 5 is a left side view thereof; FIG. 6 is a top view thereof; FIG. 7 is a bottom view thereof; FIG. 8 is a perspective view of an electric hair removal device without a cap in accordance with the present invention; FIG. 9 is a front view thereof; FIG. 10 is a rear view thereof; FIG. 11 is a right side view thereof; FIG. 12 is a left side view thereof; FIG. 13 is a top view thereof; FIG. 14 is a bottom view thereof; FIG. 15 is a perspective view of a cap for an electric hair removal device in accordance with the present invention; FIG. 16 is a front view thereof; FIG. 17 is a rear view thereof; FIG. 18 is a right side view thereof; FIG. 19 is a left side view thereof; and, FIG. 20 is a top view thereof.

The invention pertains to an ornamental design for an article of manufacture. The broken lines illustrate portions of the electric hair removal device and form no part of the claimed design.

1 Claim, 15 Drawing Sheets

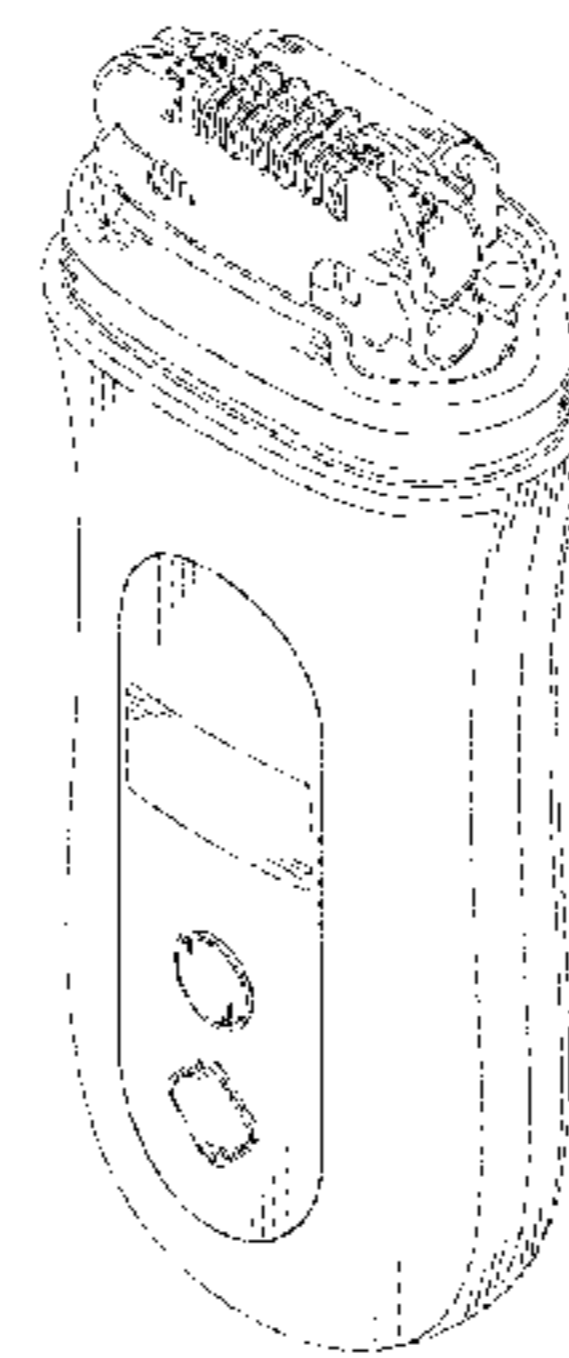
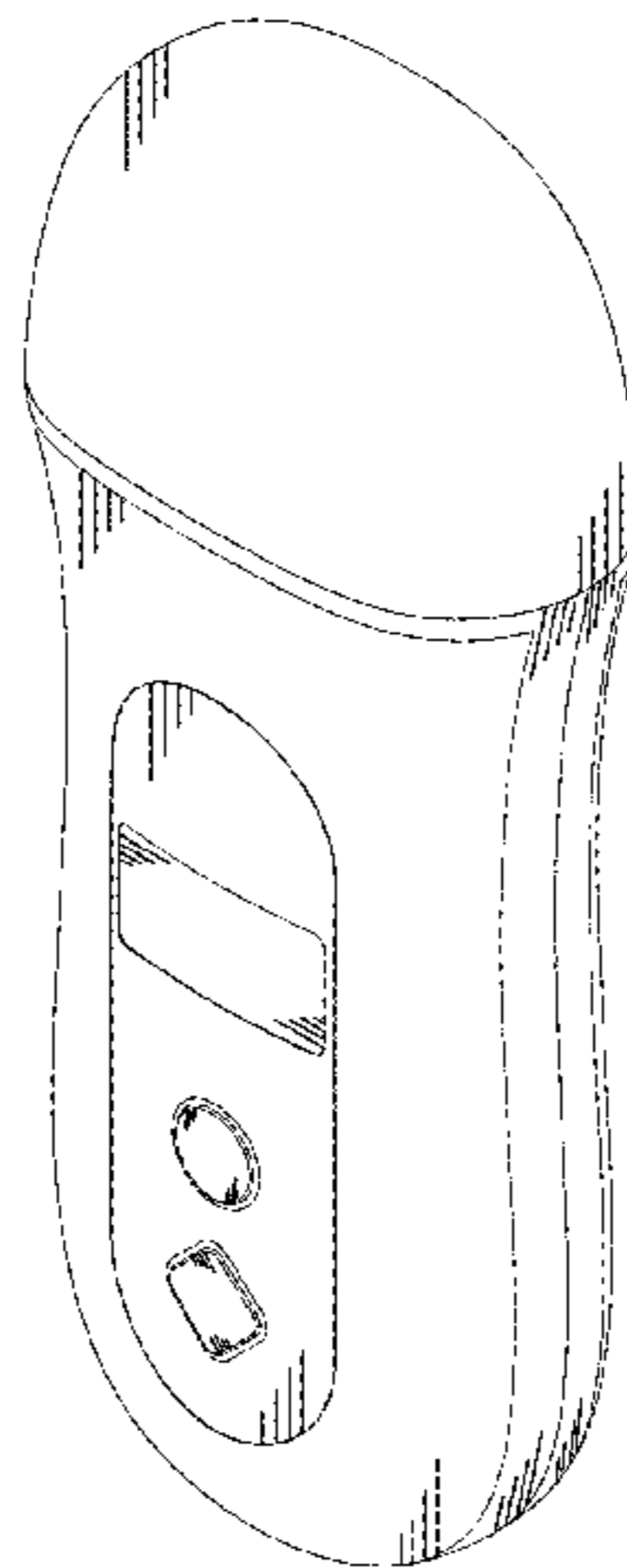

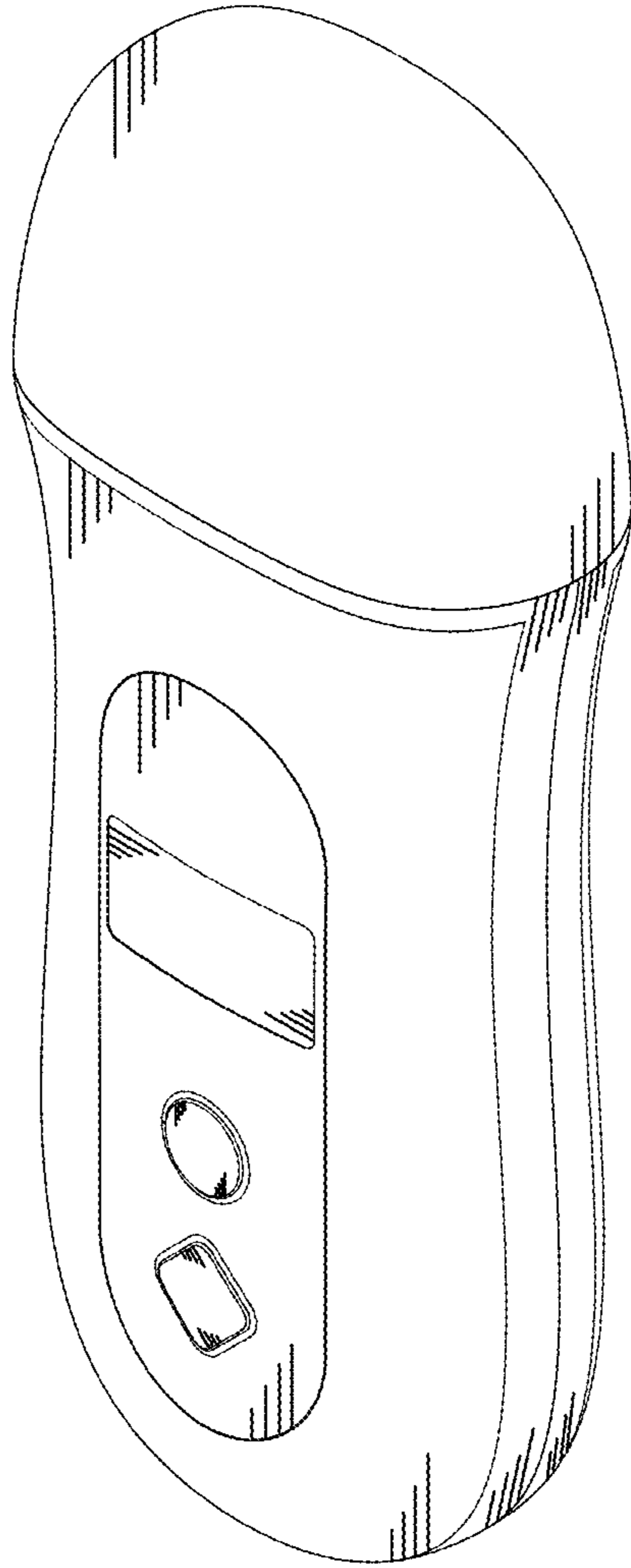

FIG. 1

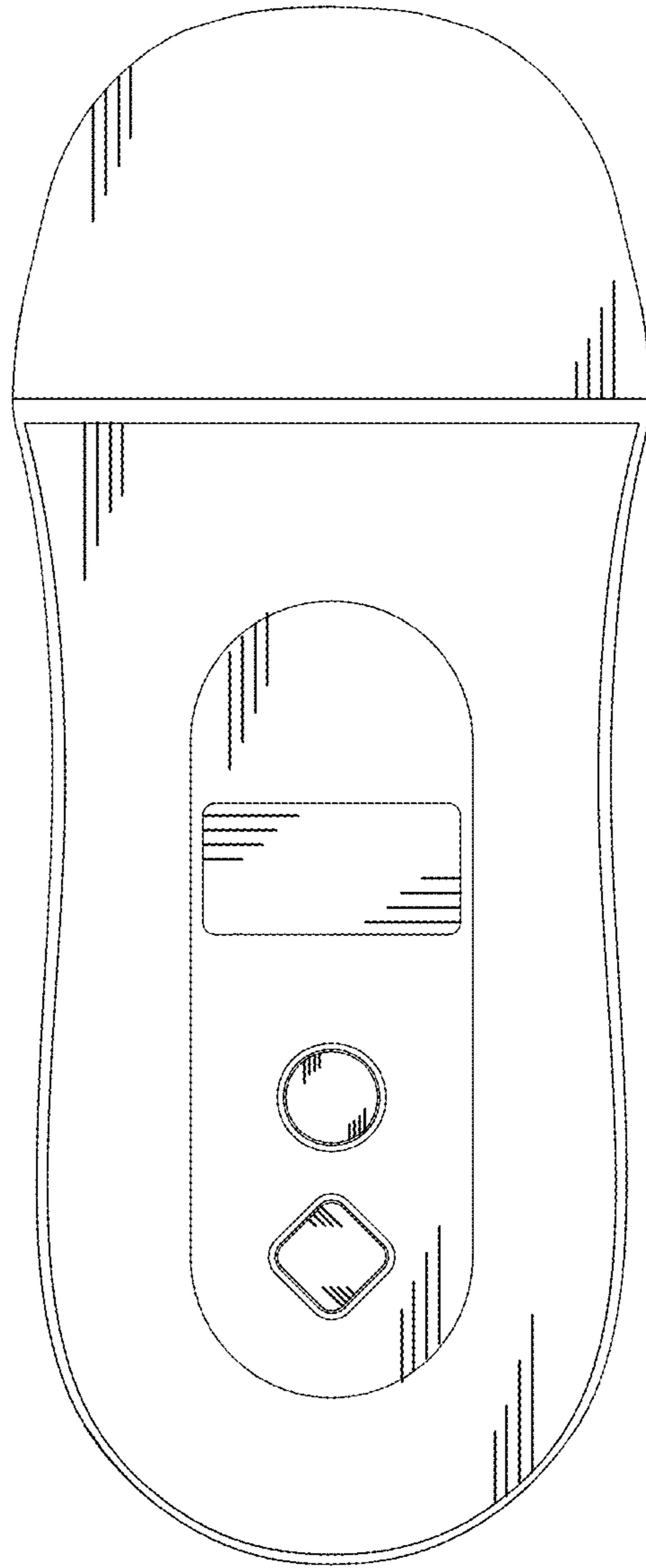

FIG. 2

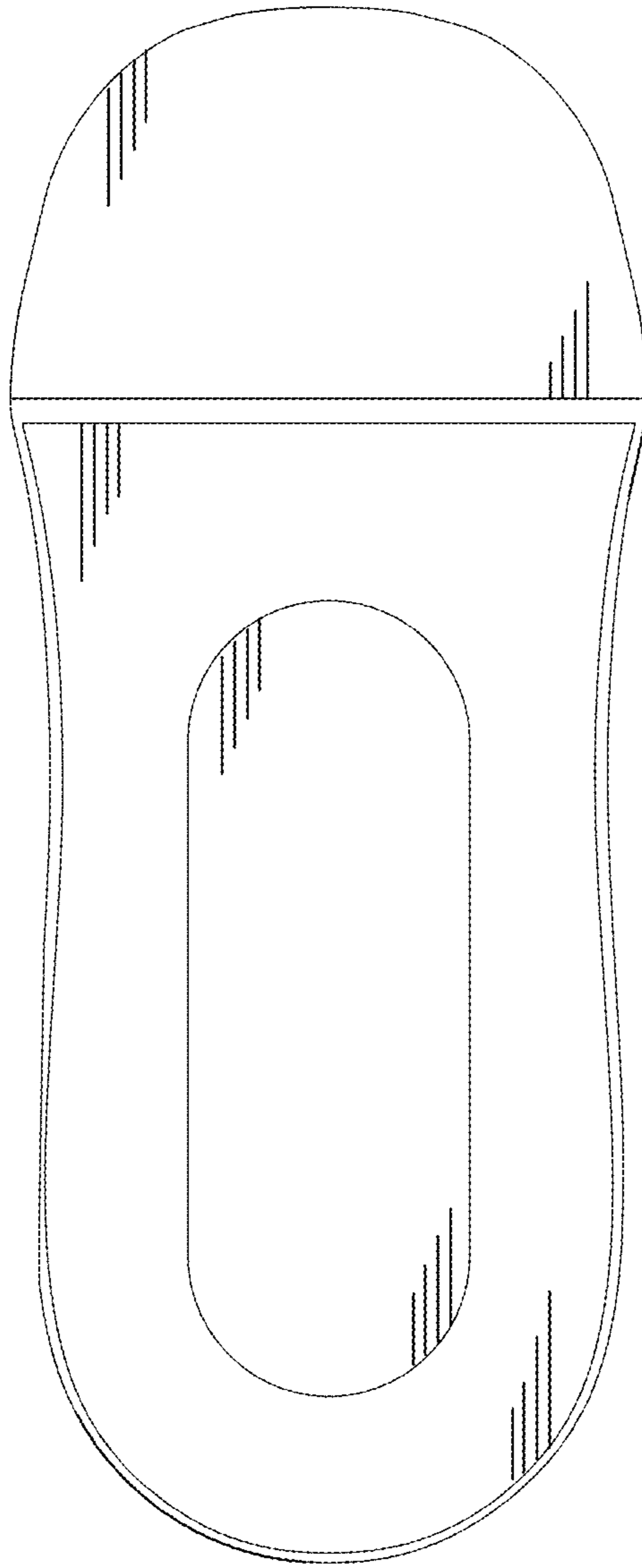

FIG. 3

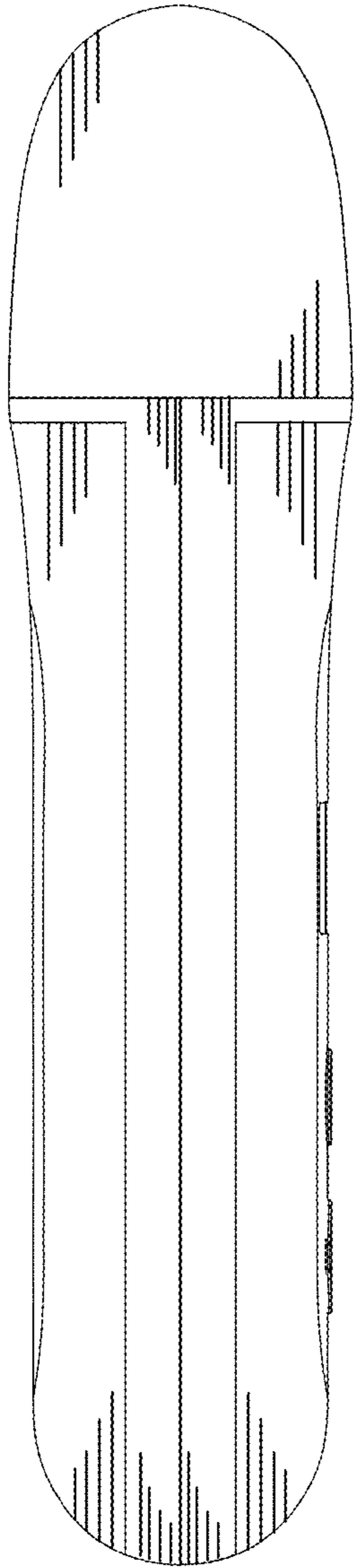

FIG. 4

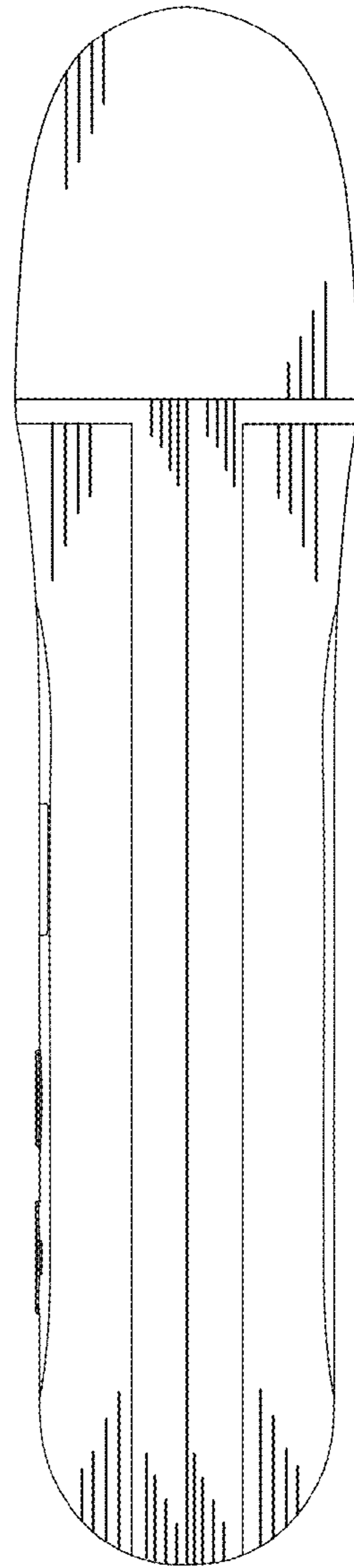

FIG. 5

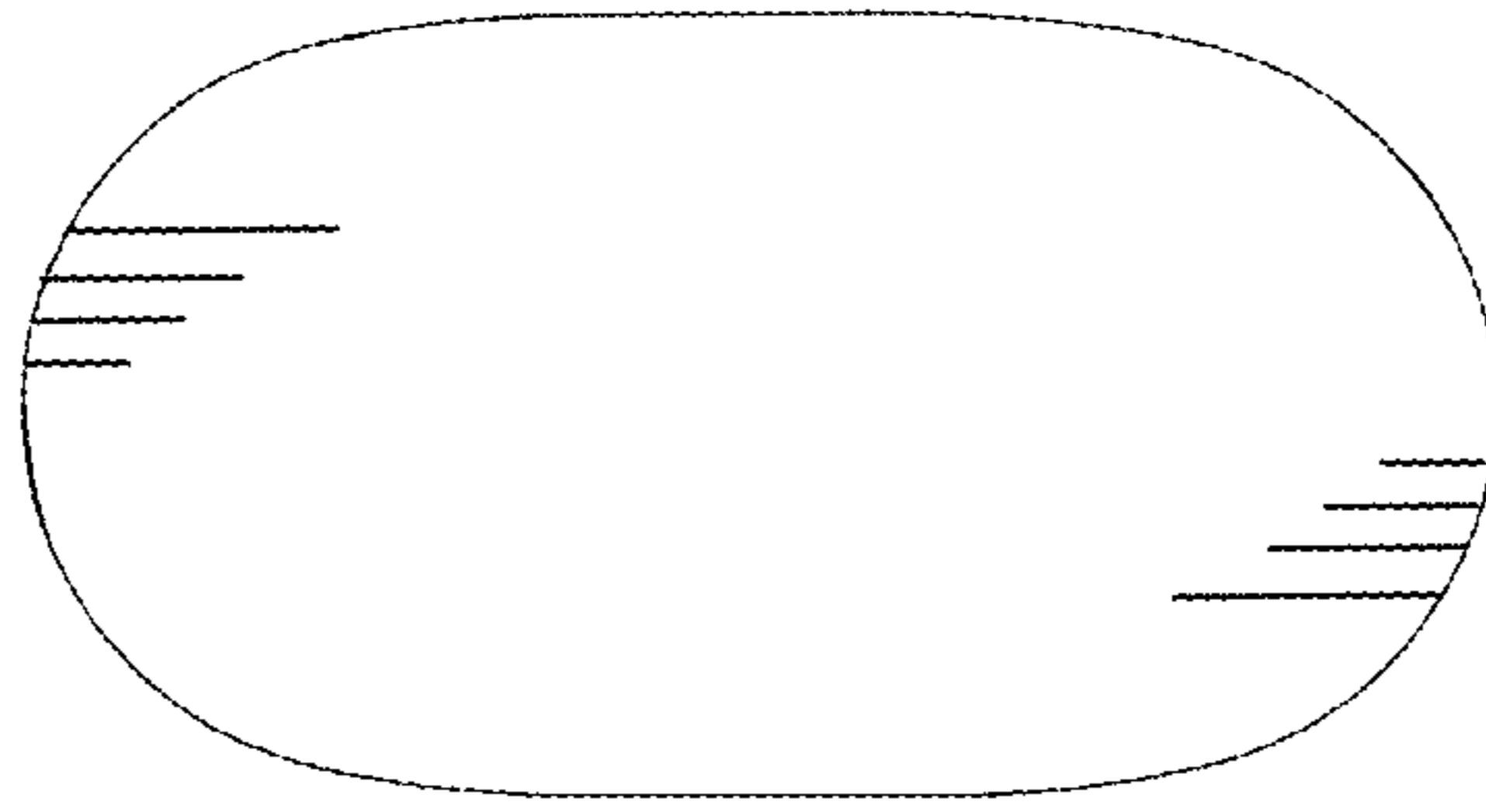

FIG. 6

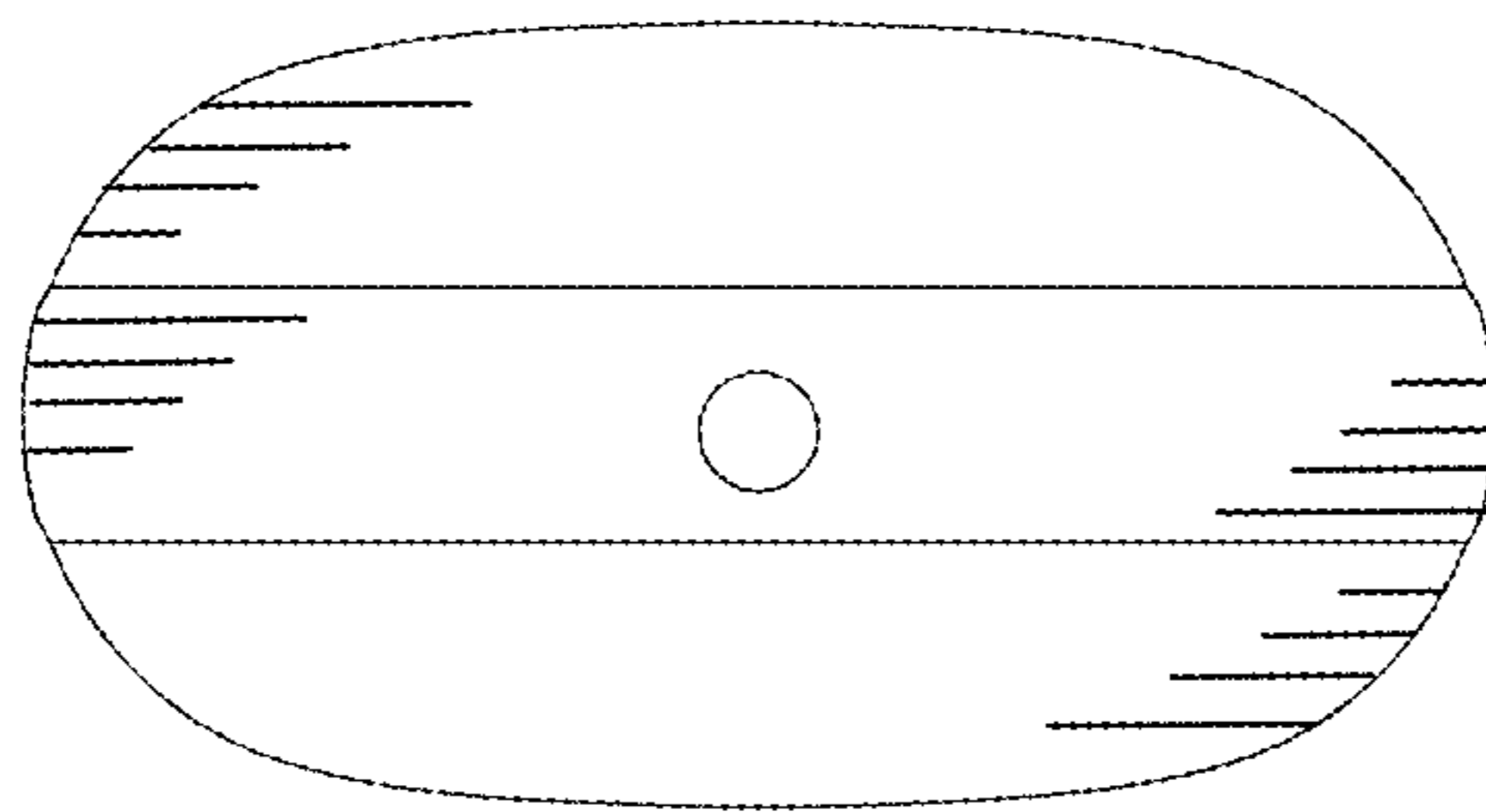

FIG. 7

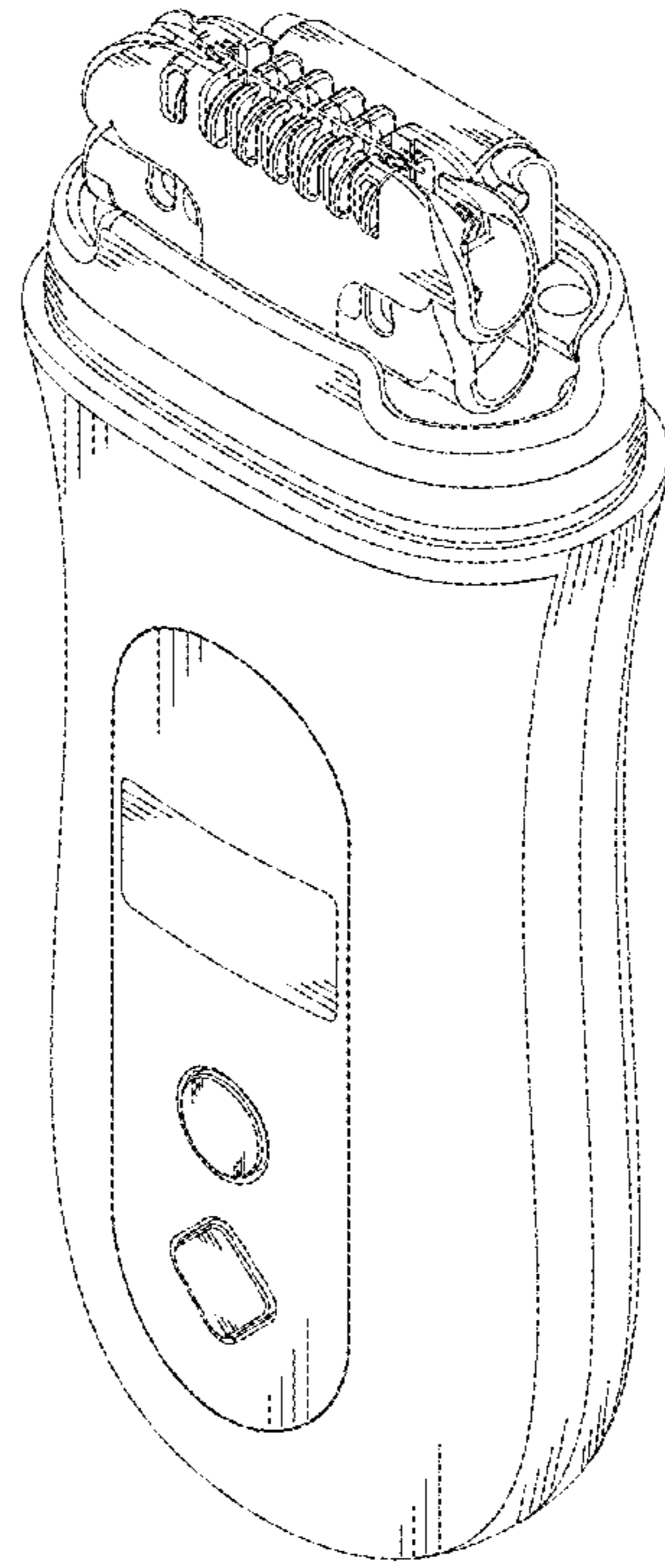

FIG. 8

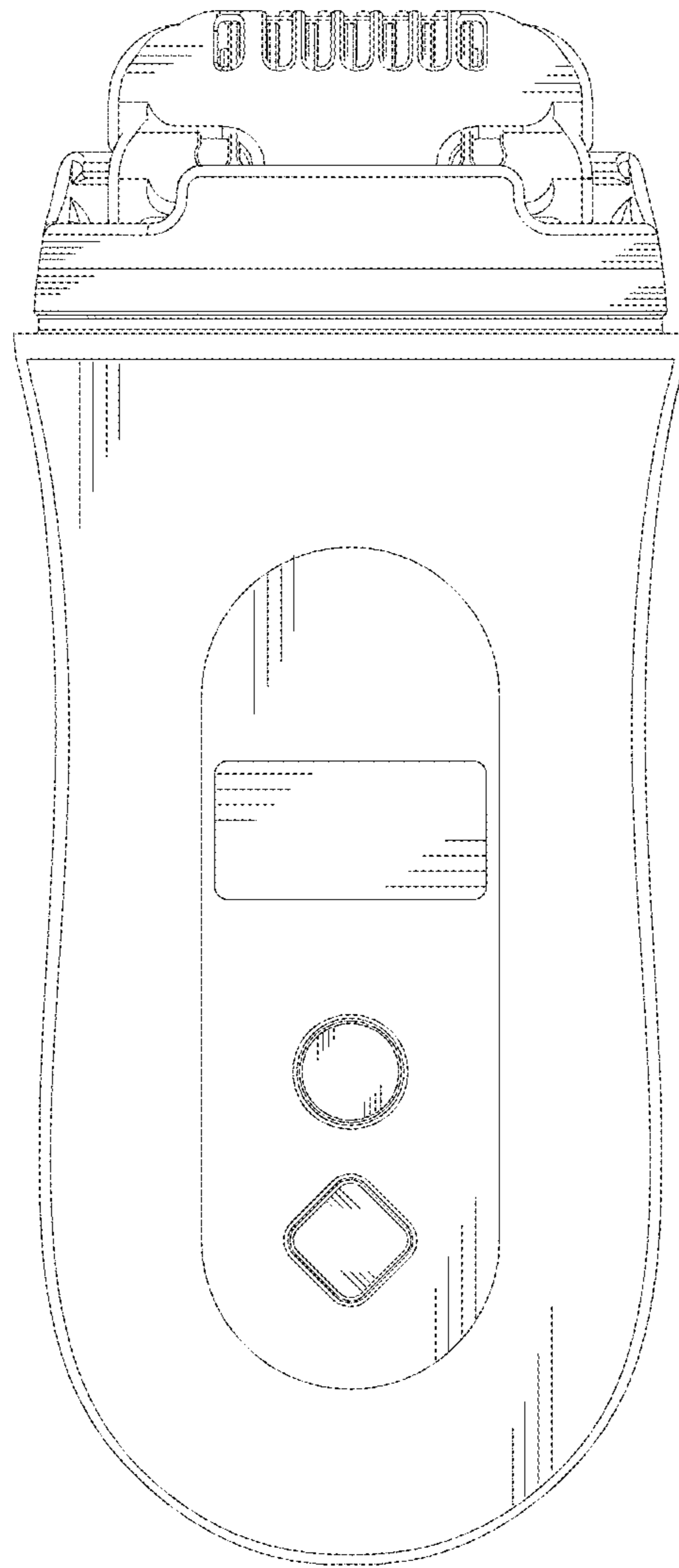

FIG. 9

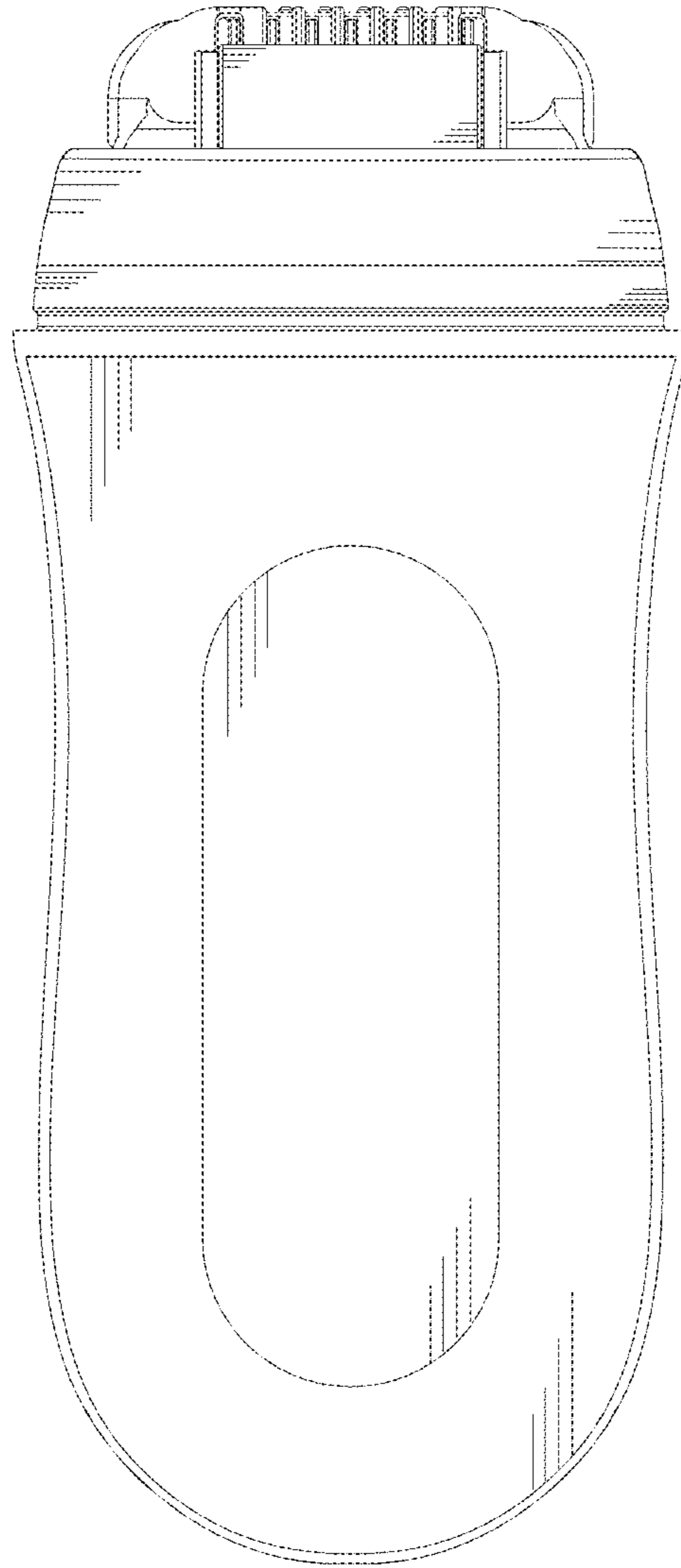

FIG. 10

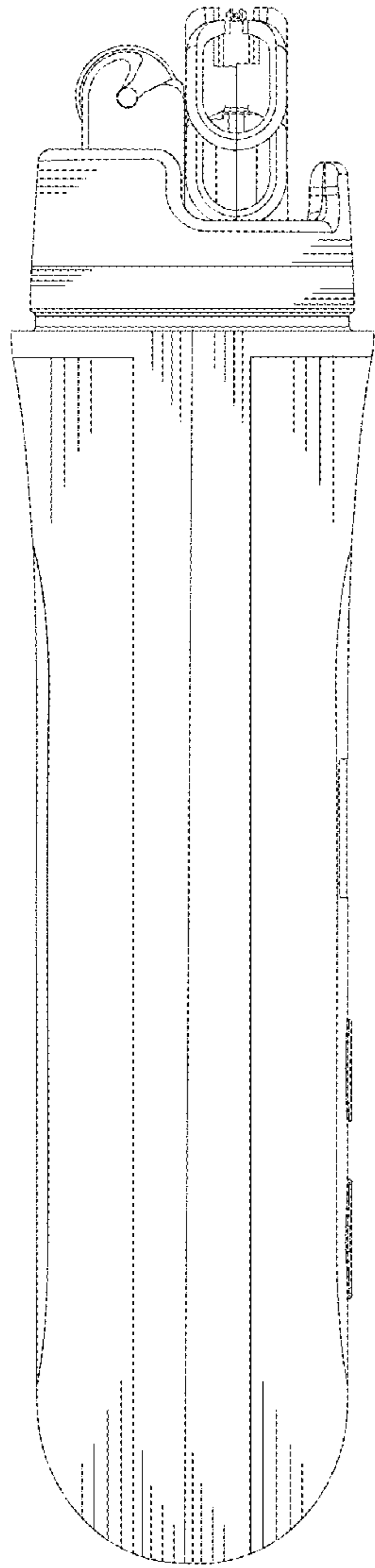

FIG. 11

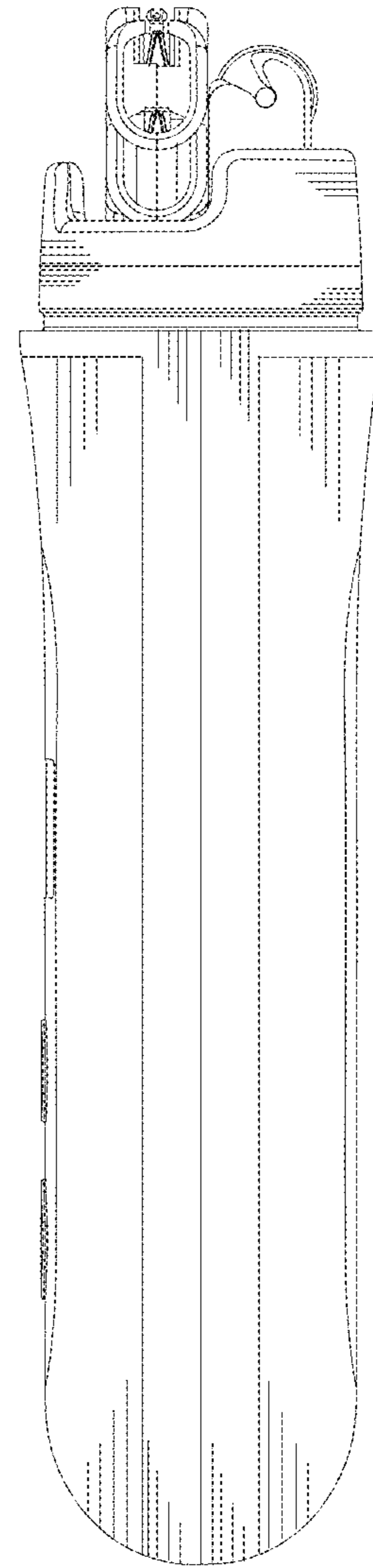

FIG. 12

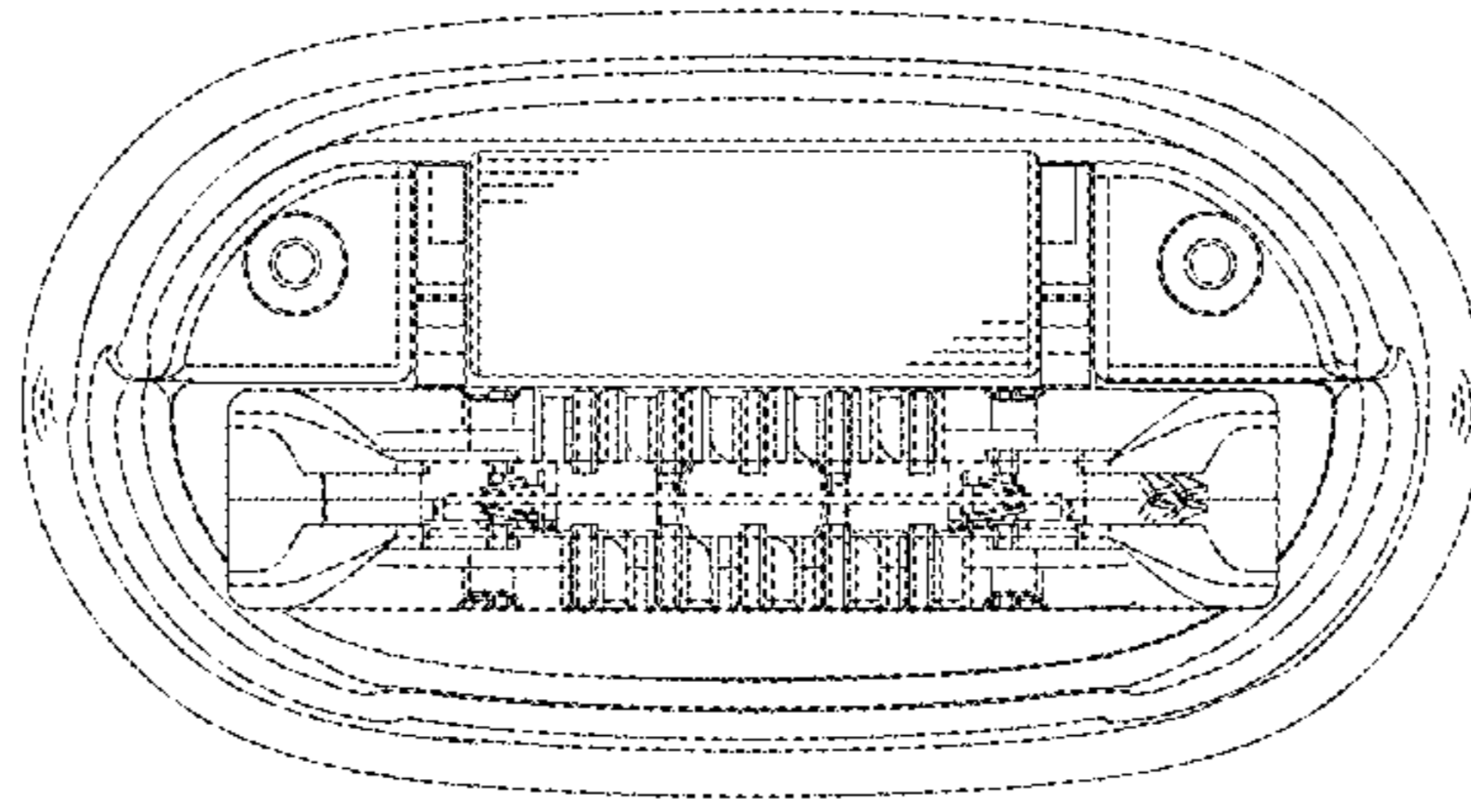

FIG. 13

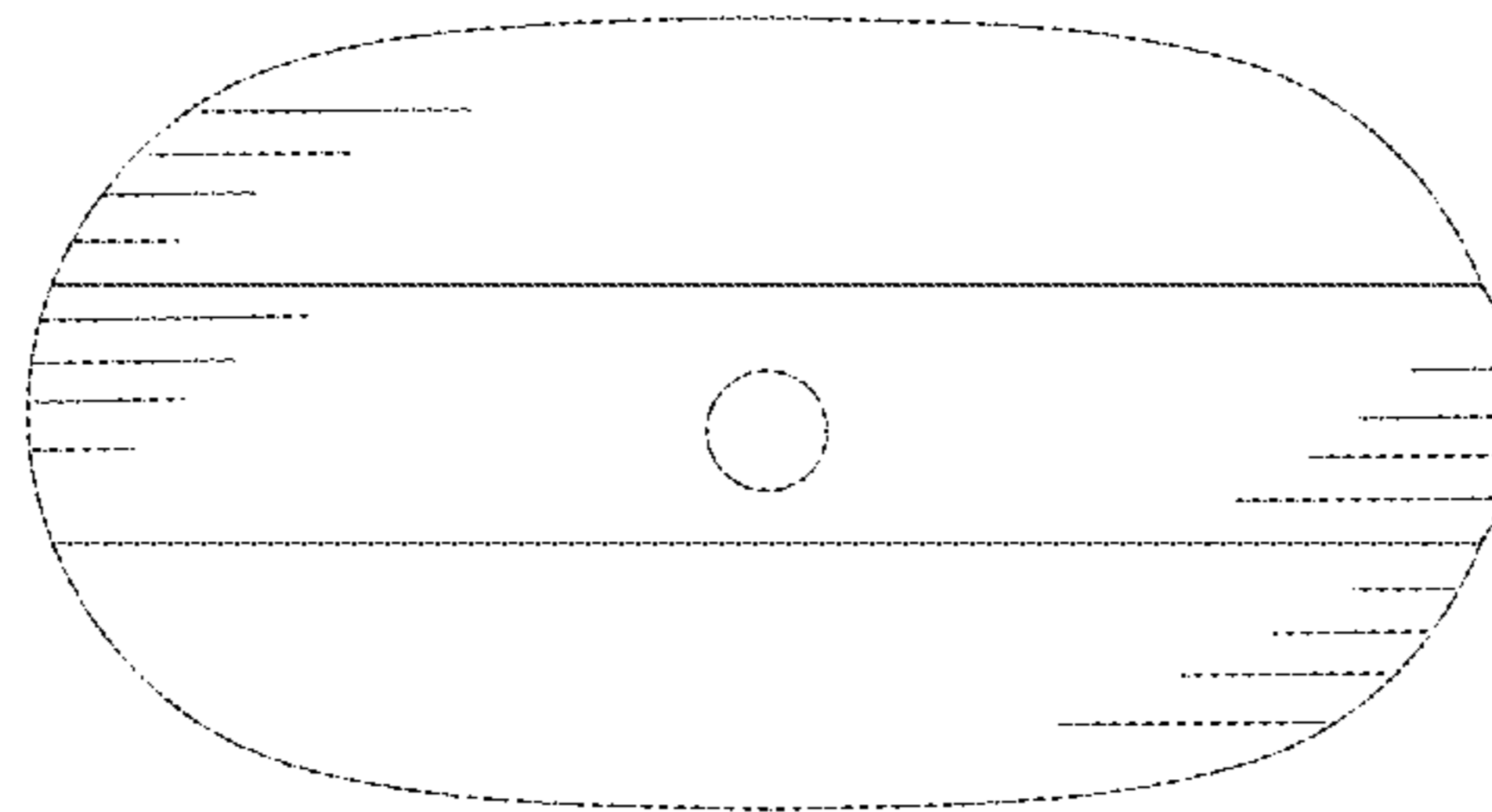

FIG. 14

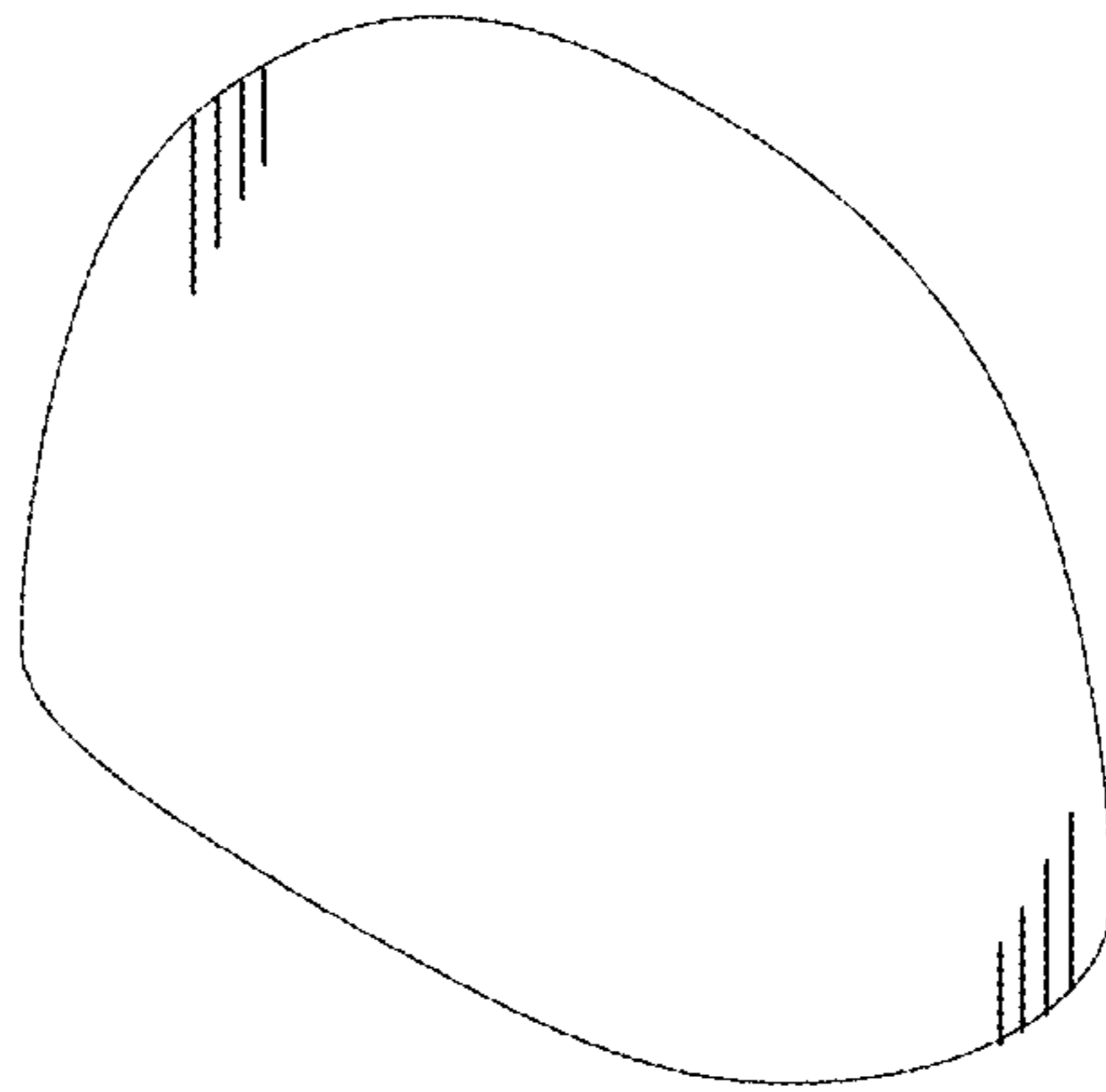

FIG. 15

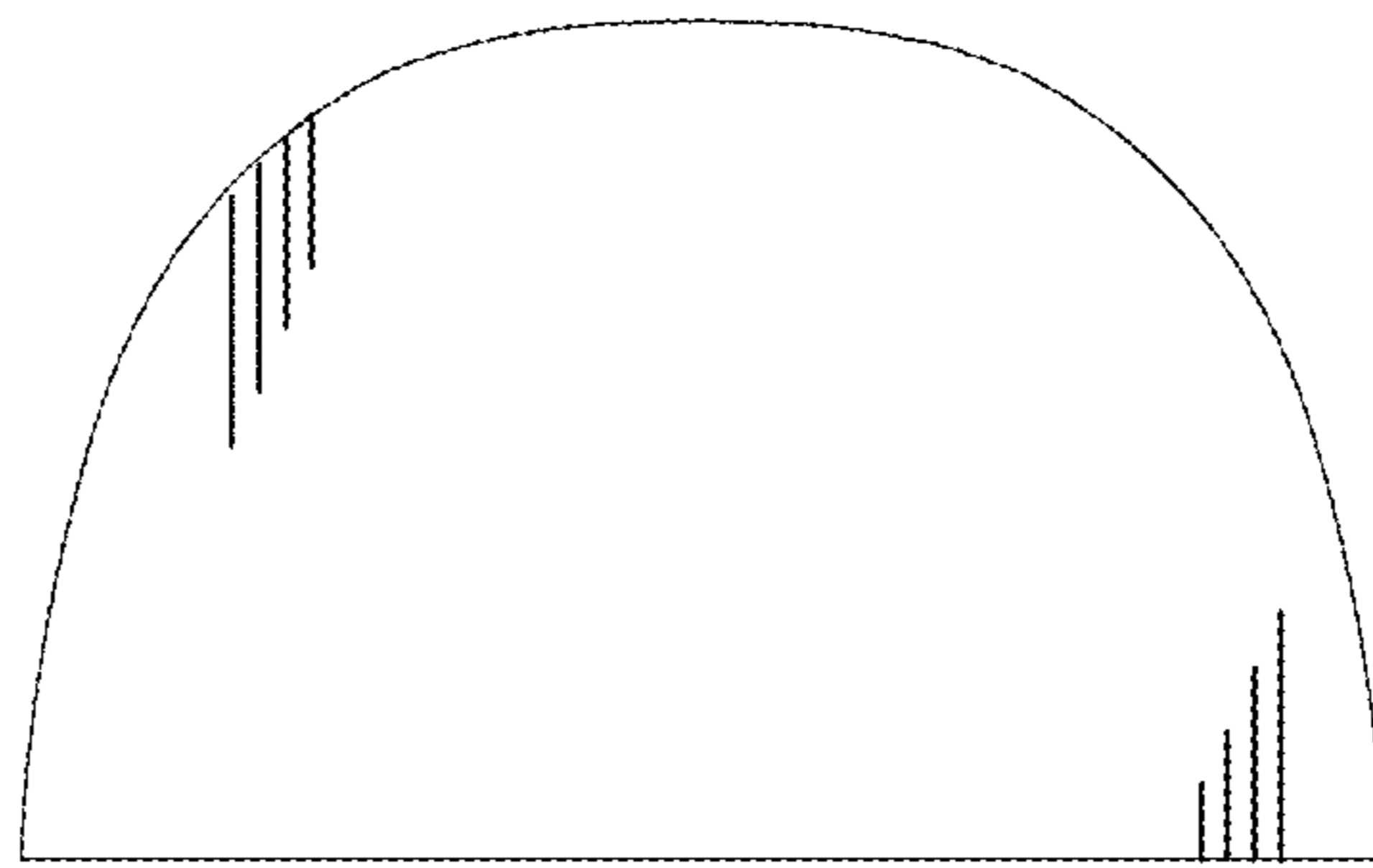

FIG. 16

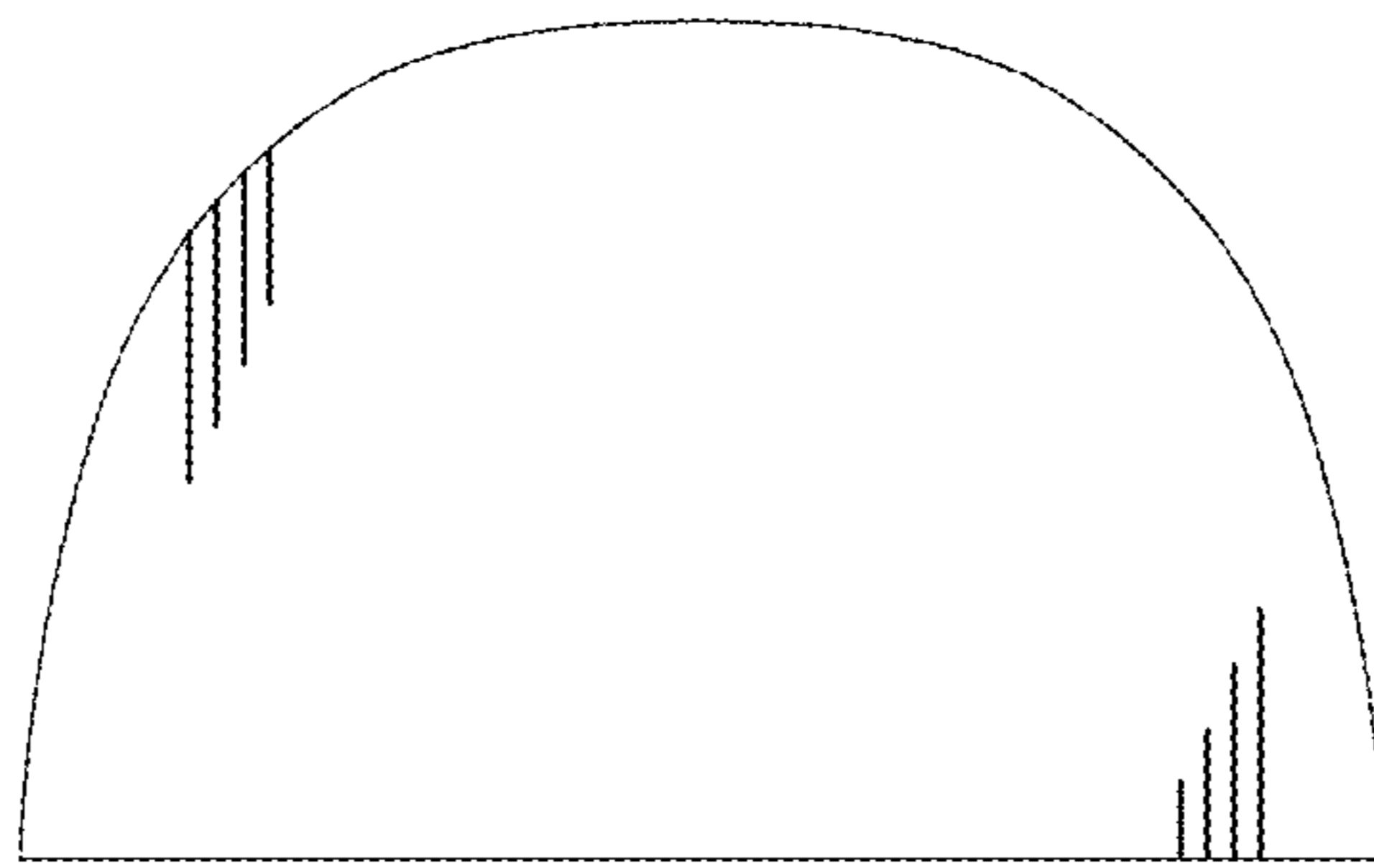

FIG. 17

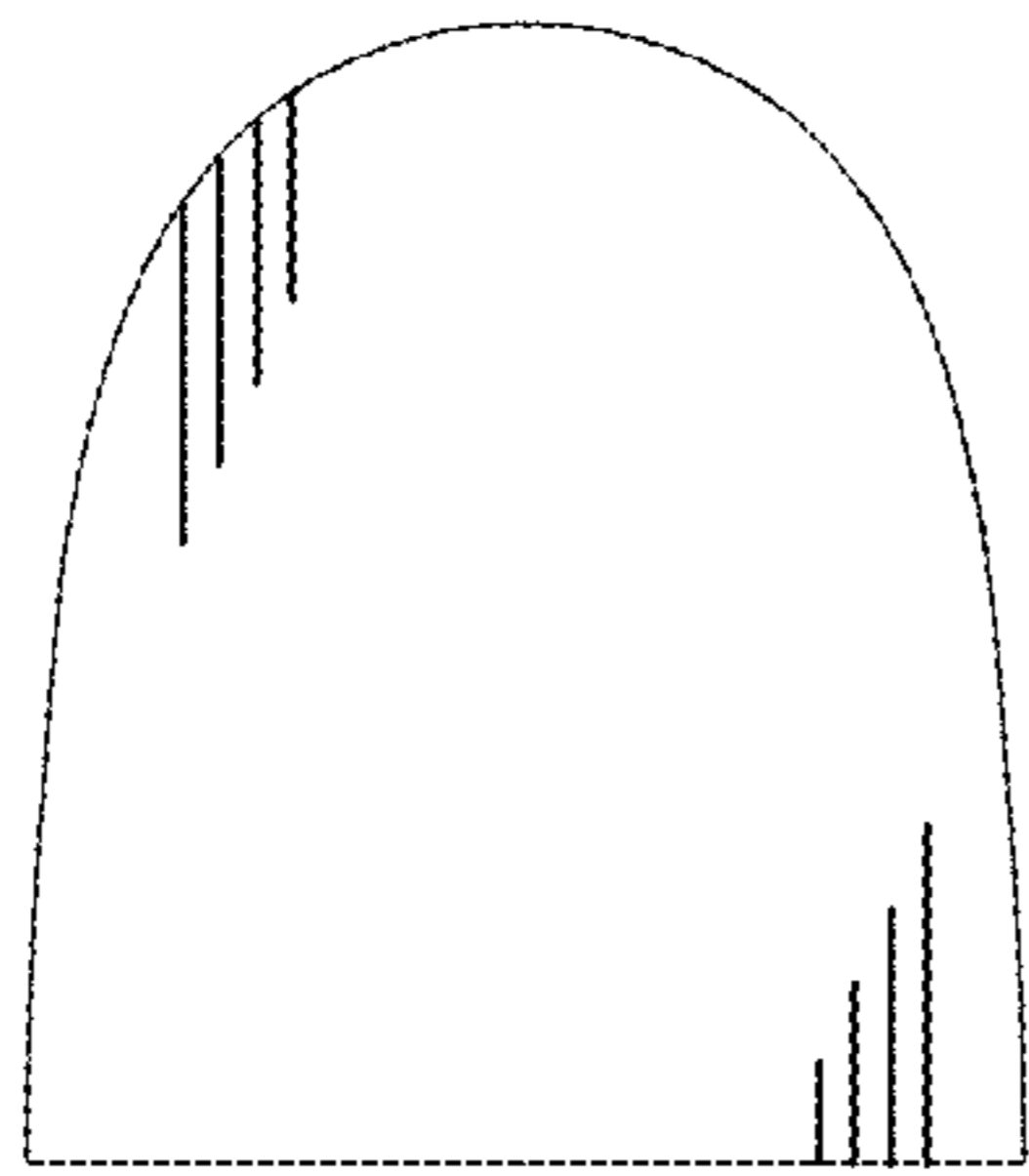

FIG. 18

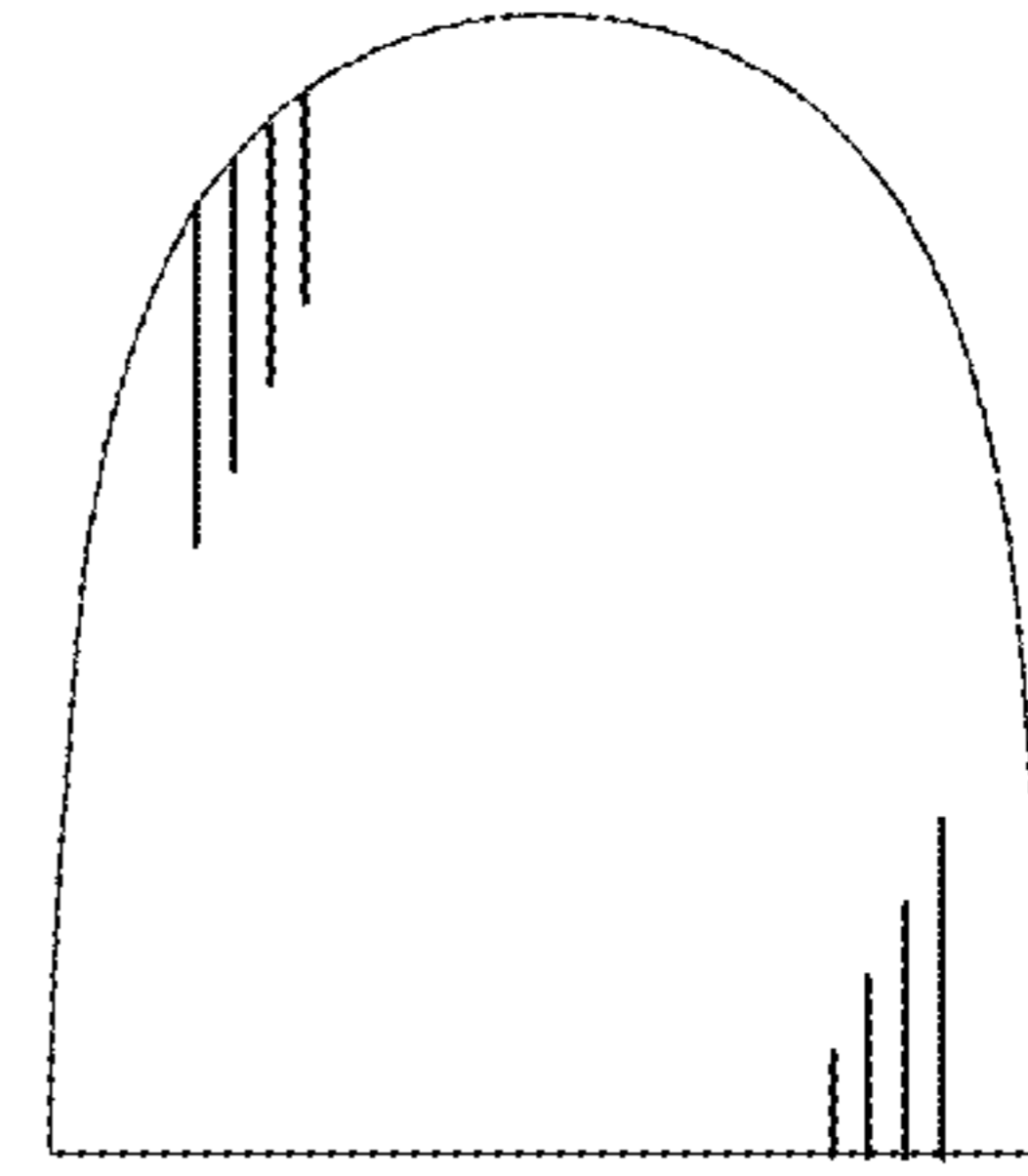

FIG. 19

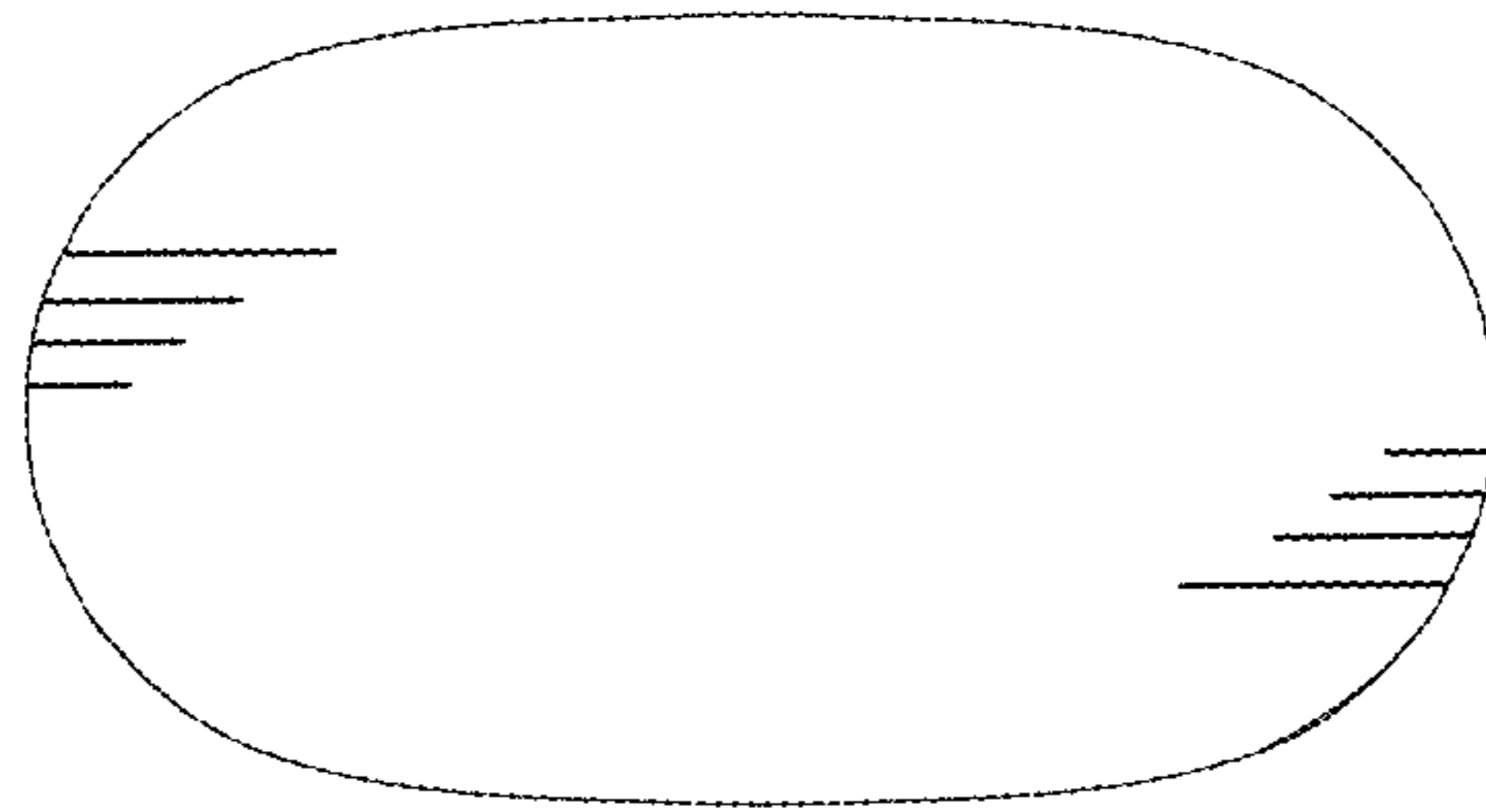

FIG. 20