



US00D771291S

(12) **United States Design Patent** (10) **Patent No.:** **US D771,291 S**
Tsai (45) **Date of Patent:** **** Nov. 8, 2016**

(54) **VEHICLE LIGHT**

D561,358 S * 2/2008 Tachibana D26/28
D570,007 S * 5/2008 Hsu D26/28
D582,587 S * 12/2008 Yang D26/28
D593,232 S * 5/2009 Koman D26/28

(71) Applicant: **JUN YAN AUTO INDUSTRIAL CO., LTD.**, Tainan (TW)

* cited by examiner

(72) Inventor: **Ming-Hsien Tsai**, Tainan (TW)

Primary Examiner — Marcus Jackson

(73) Assignee: **Jun Yan Auto Industrial Co., Ltd.**, Tainan (TW)

(74) *Attorney, Agent, or Firm* — Rosenberg, Klein & Lee

(**) Term: **15 Years**

(21) Appl. No.: **29/543,610**

(57) **CLAIM**

The ornamental design for a vehicle light, as shown and described.

(22) Filed: **Oct. 27, 2015**

(51) **LOC (10) Cl.** **26-06**

(52) **U.S. Cl.**
USPC **D26/28**

DESCRIPTION

(58) **Field of Classification Search**
USPC D26/28-36; 362/61, 80-83, 267-269,
362/459-468, 475-478, 485-487
CPC F21S 48/00; F21S 48/10; F21S 48/115;
F21S 48/225; F21S 48/1233; F21S 48/1266;
F21S 48/1388; F21S 48/2268; F21V 21/04
See application file for complete search history.

FIG. 1 is a perspective view of a vehicle light showing my new design;
FIG. 2 is a front elevational view thereof;
FIG. 3 is a rear elevational view thereof;
FIG. 4 is a left side elevational view thereof;
FIG. 5 is a right side elevational view thereof;
FIG. 6 is a top plan view thereof; and,
FIG. 7 is a bottom plan view thereof.
The broken lines are shown in figures for illustrative purposes only and form no part of the claimed design.

(56) **References Cited**

U.S. PATENT DOCUMENTS

D538,956 S * 3/2007 Ishii D26/28
D556,349 S * 11/2007 Golden D26/28

1 Claim, 7 Drawing Sheets

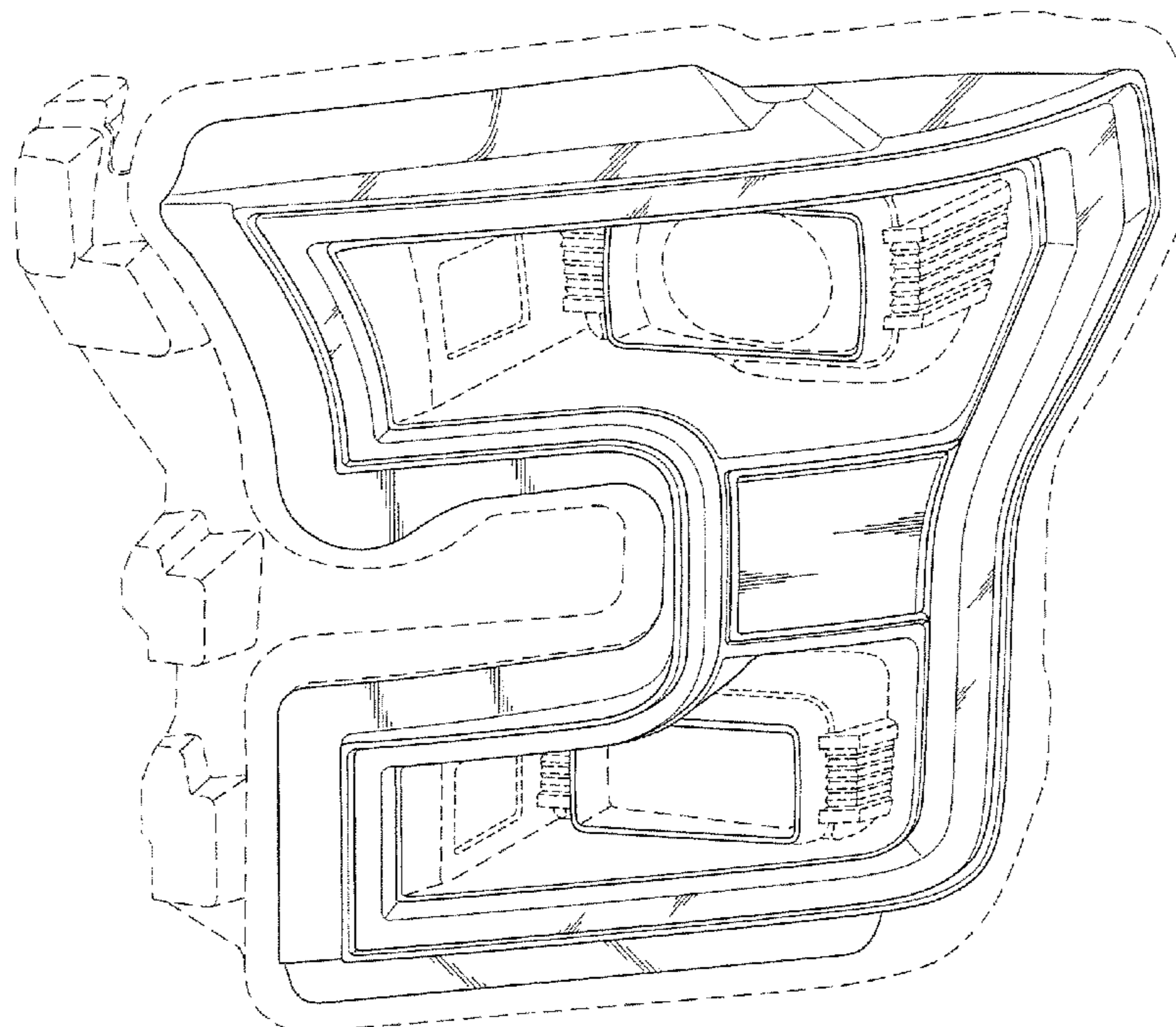

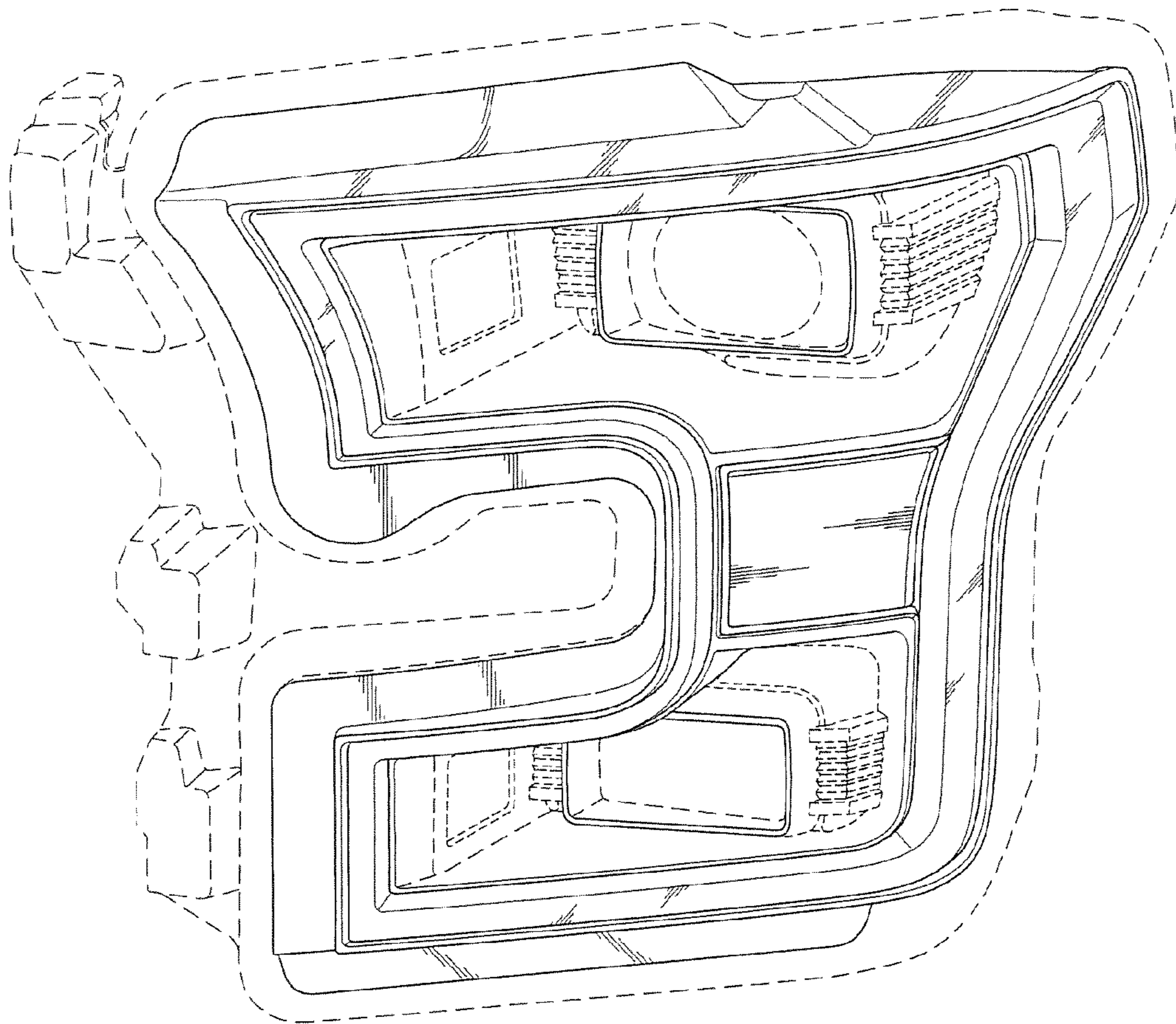

FIG. 1

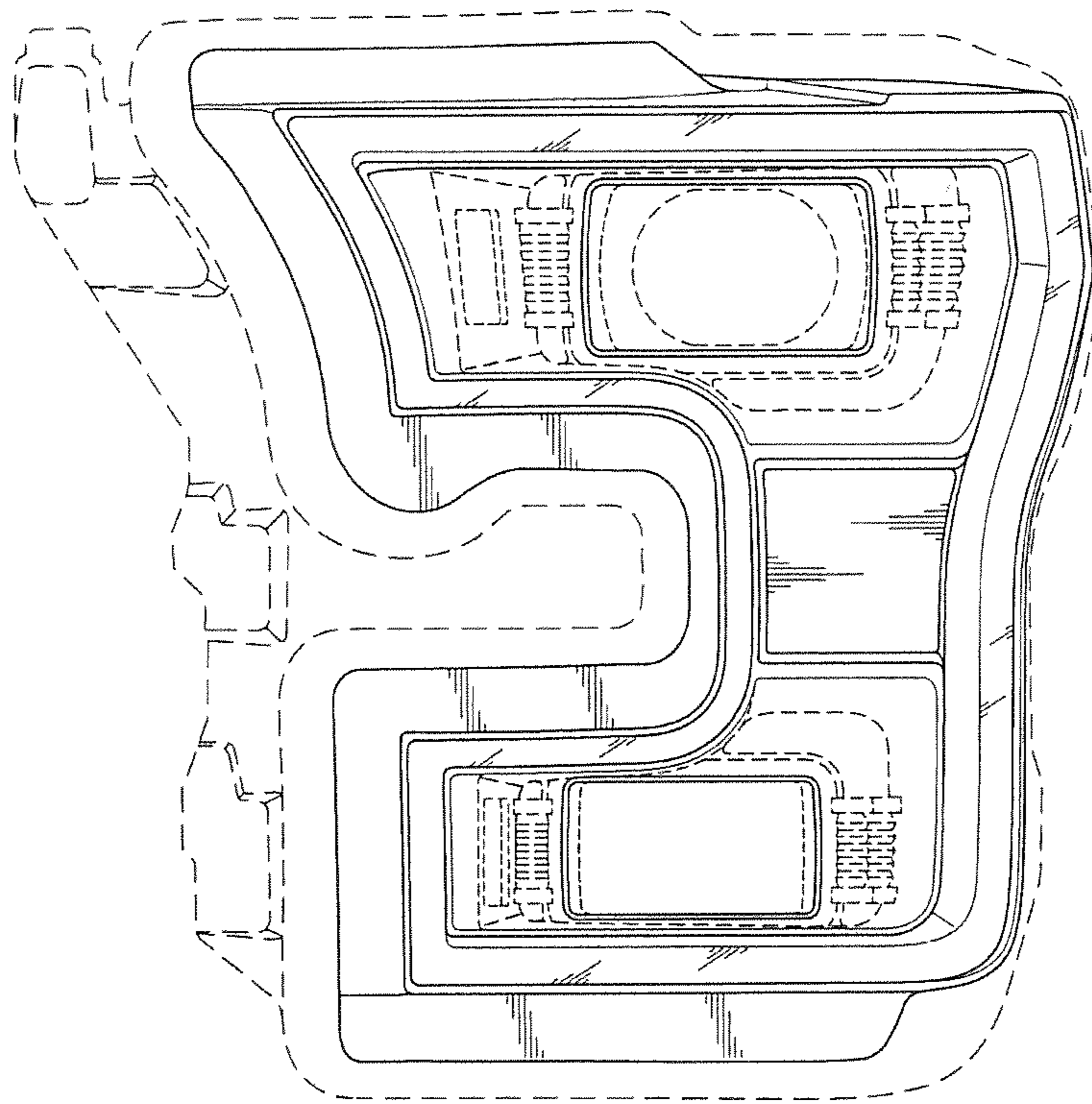

FIG. 2

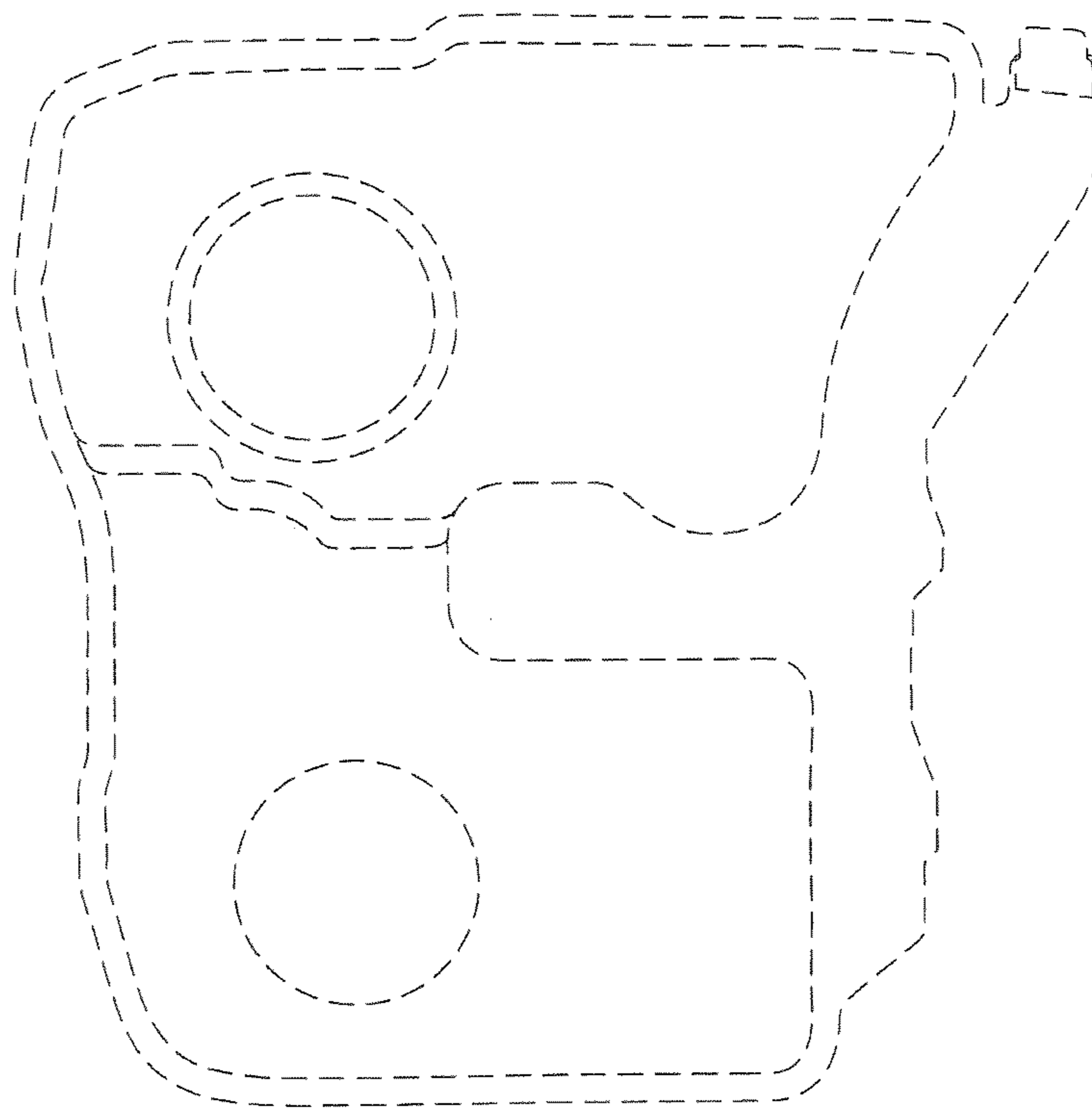

FIG. 3

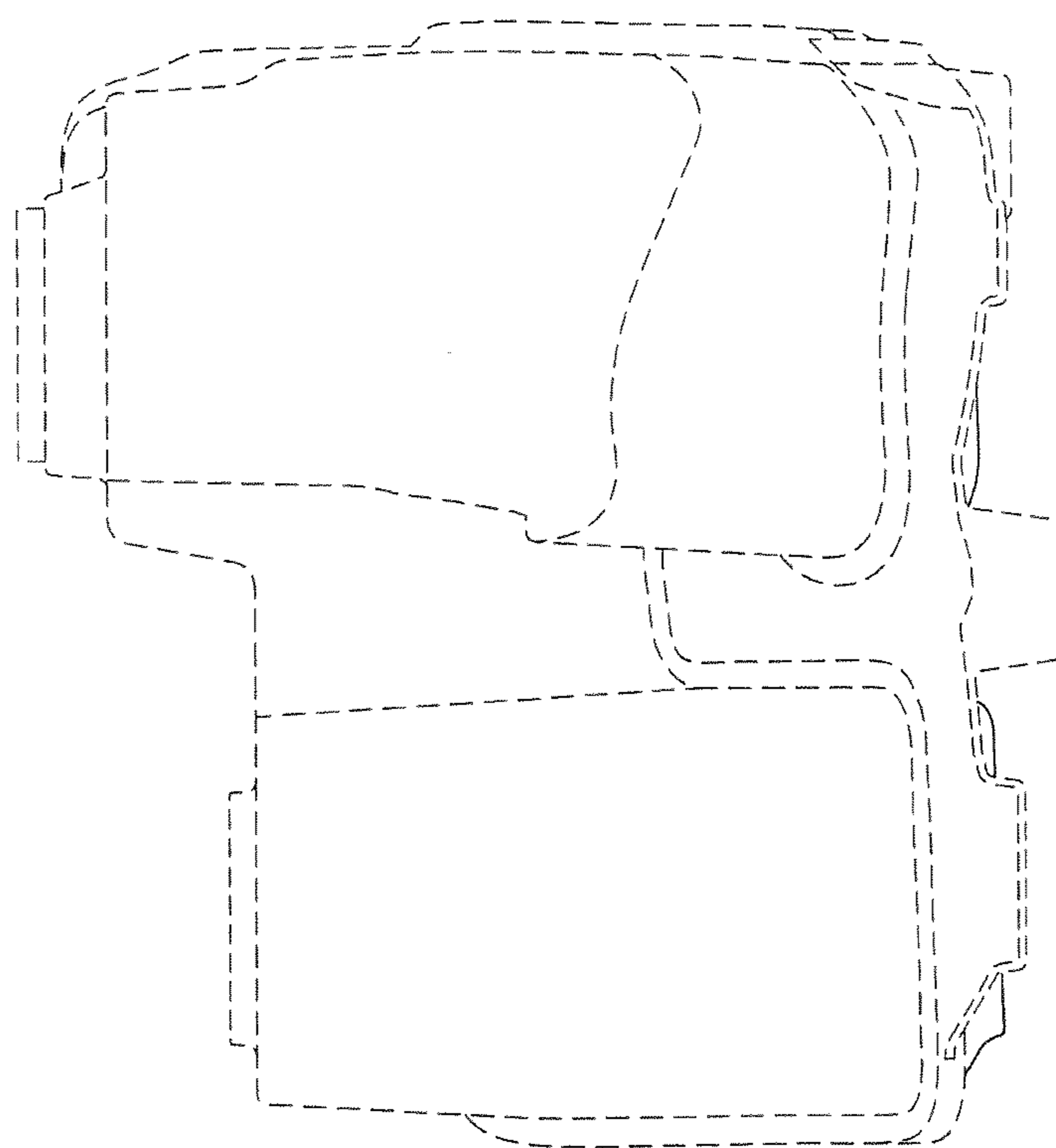

FIG. 4

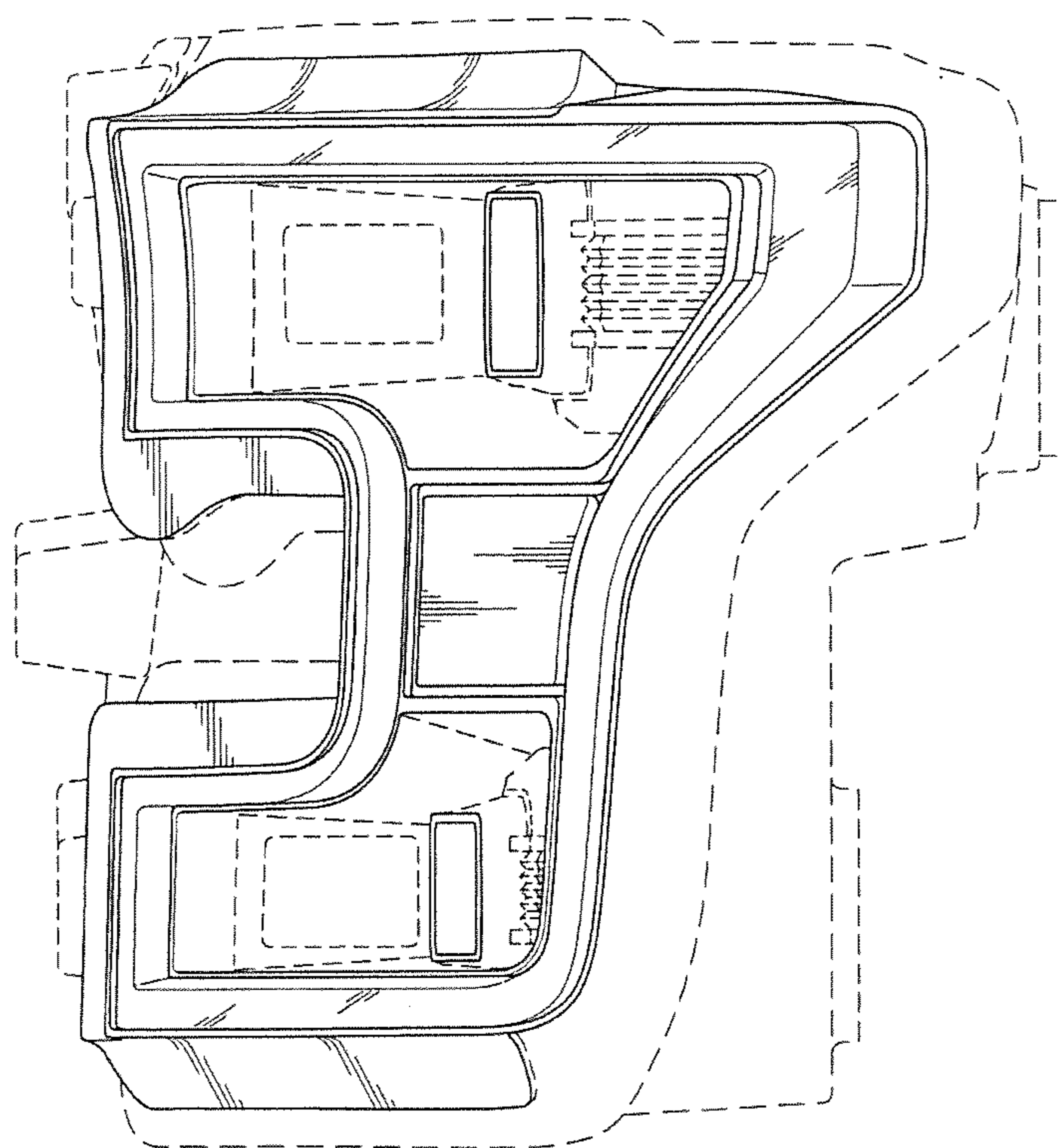

FIG. 5

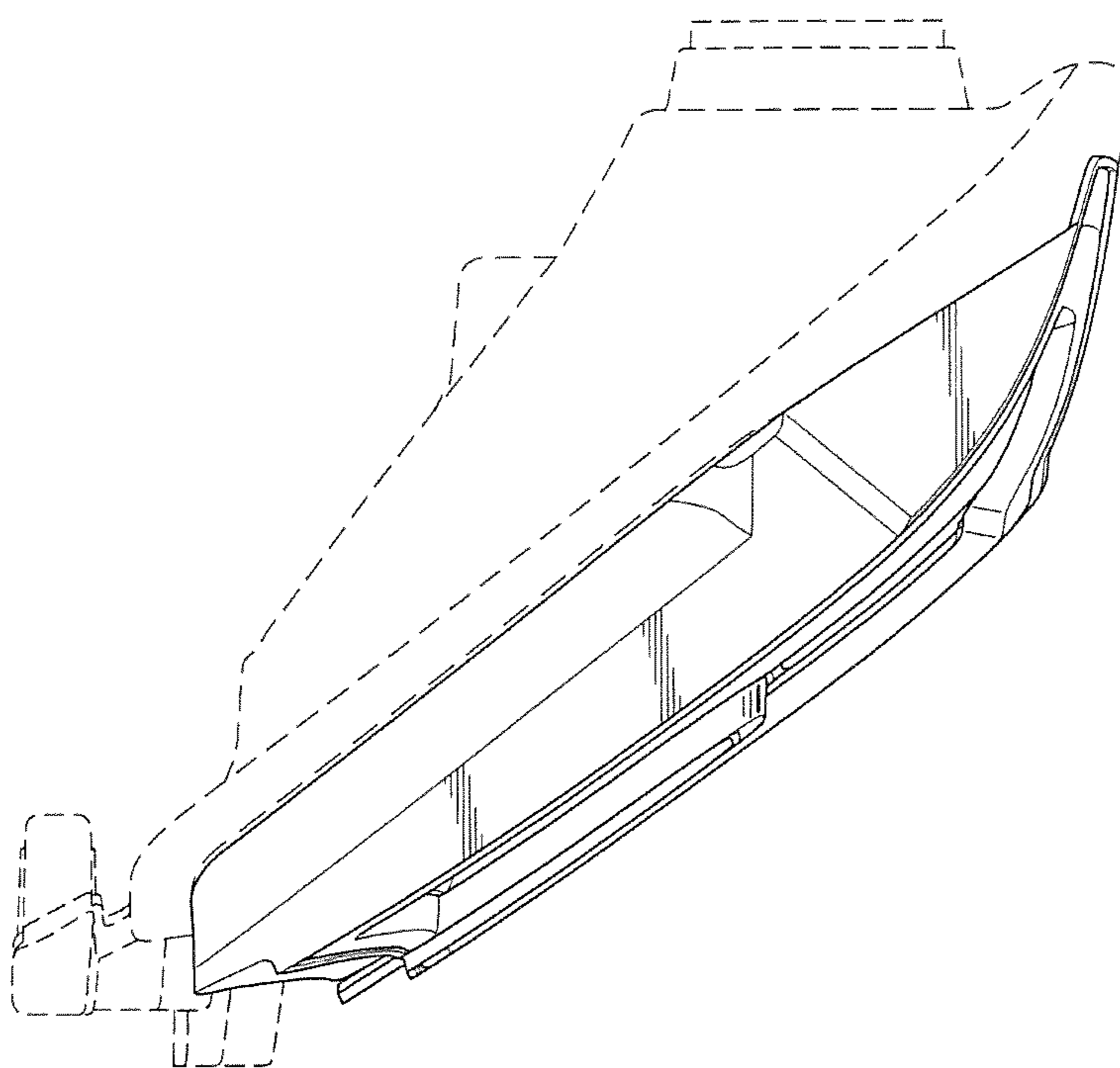

FIG. 6

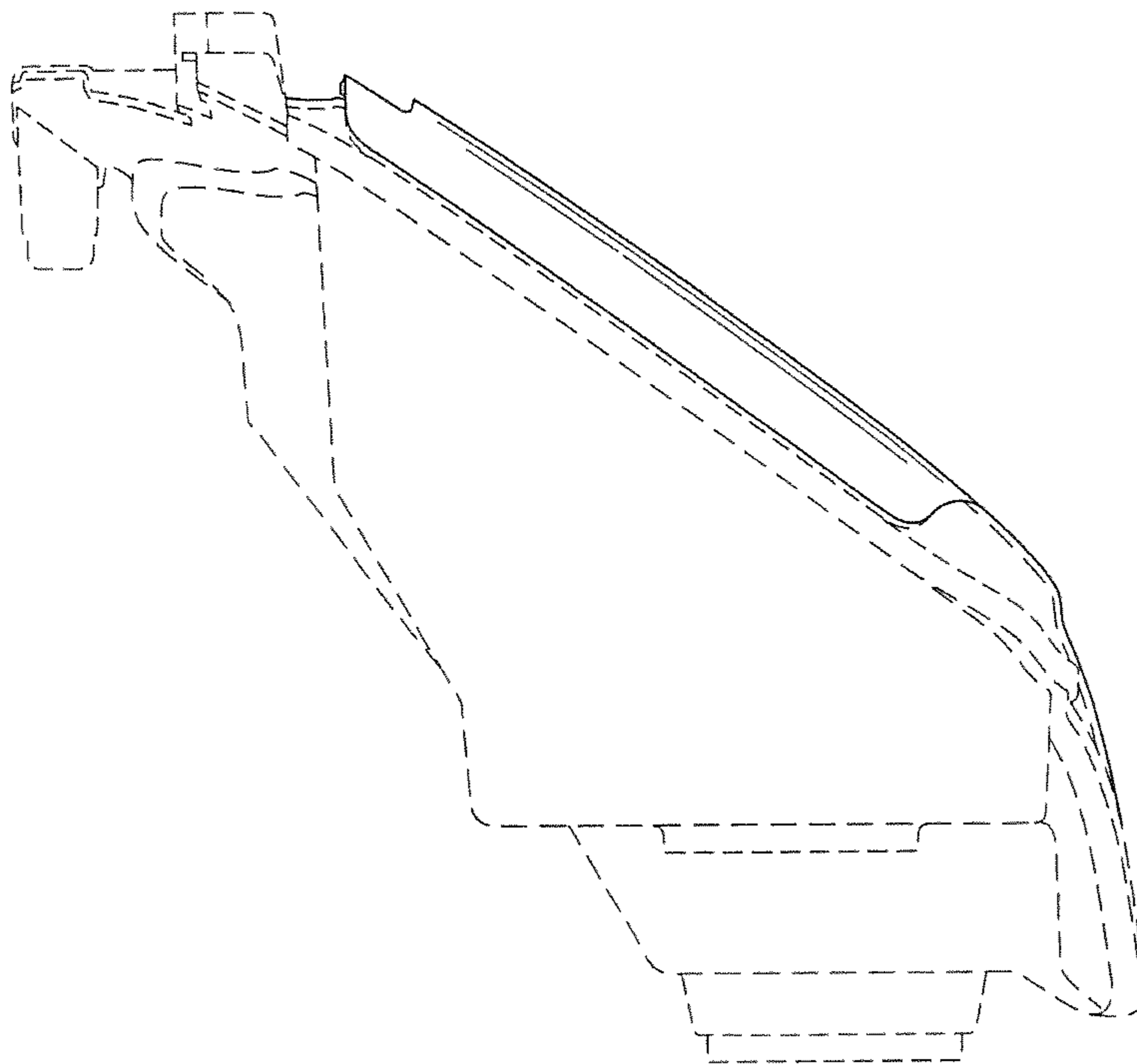

FIG. 7