



US00D771254S

(12) **United States Design Patent** (10) **Patent No.:** **US D771,254 S**
Gopichandran (45) **Date of Patent:** **** Nov. 8, 2016**

- (54) **ANIMAL PESSARY**
- (71) Applicant: **Ostara Biomedical Ltd**, Liverpool, Merseyside (GB)
- (72) Inventor: **Nadia Gopichandran**, Liverpool (GB)
- (73) Assignee: **Ostara Biomedical Ltd**, Liverpool, Merseyside (GB)
- (**) Term: **14 Years**
- (21) Appl. No.: **29/510,804**
- (22) Filed: **Dec. 3, 2014**
- (51) **LOC (10) Cl.** **24-02**
- (52) **U.S. Cl.**
USPC **D24/141**
- (58) **Field of Classification Search**
USPC D24/141, 143
CPC A61F 6/00; A61F 6/08; A61F 6/12;
A61F 6/18; A61F 2/0009; A61F 2/0022;
A61F 2/005
See application file for complete search history.

(56) **References Cited**

U.S. PATENT DOCUMENTS

6,770,025	B2 *	8/2004	Zunker	A61F 2/005 600/29
8,845,664	B2 *	9/2014	Pedrick	A61F 6/08 606/119
2013/0025604	A1 *	1/2013	Harmanli	A61F 2/005 128/834
2013/0245661	A1 *	9/2013	Altchek	A61F 6/08 606/191
2015/0099924	A1 *	4/2015	Carey	A61F 6/12 600/37
2015/0190305	A1 *	7/2015	Maurette	A61F 6/08 128/830
2016/0022475	A1 *	1/2016	Honda	A61F 6/08 128/836

* cited by examiner

Primary Examiner — Wan Laymon
(74) Attorney, Agent, or Firm — Myers Bigel & Sibley, P.A.

(57) **CLAIM**
The ornamental design for an animal pessary, as shown and described.

DESCRIPTION

FIG. 1 is a front, side perspective view of a first embodiment of the animal pessary showing my design;
 FIG. 2 is a front view thereof;
 FIG. 3 is a rear view thereof;
 FIG. 4 is a side view thereof;
 FIG. 5 is a side view opposite that shown in FIG. 4;
 FIG. 6 is a bottom view thereof;
 FIG. 7 is a top view thereof;
 FIG. 8 is a top view of the animal pessary of FIGS. 1-7, shown in an exemplary environmental view inserted in an animal subject;
 FIG. 9 is a front, side perspective view of a second embodiment of the animal pessary showing my design;
 FIG. 10 is a front view thereof;
 FIG. 11 is a rear view thereof;
 FIG. 12 is side view thereof;
 FIG. 13 is a side view opposite that shown in FIG. 12;
 FIG. 14 is a bottom view thereof;
 FIG. 15 is a top view thereof; and,
 FIG. 16 is a top view of the animal pessary of FIGS. 10-15, shown in an exemplary environmental view inserted in an animal subject.

The broken line shown in the figures are included for the purpose of illustrating environmental structure and forms no part of the claimed design. The dashed-dot-dashed lines define the bounds of the claimed design and form no part thereof.

1 Claim, 12 Drawing Sheets

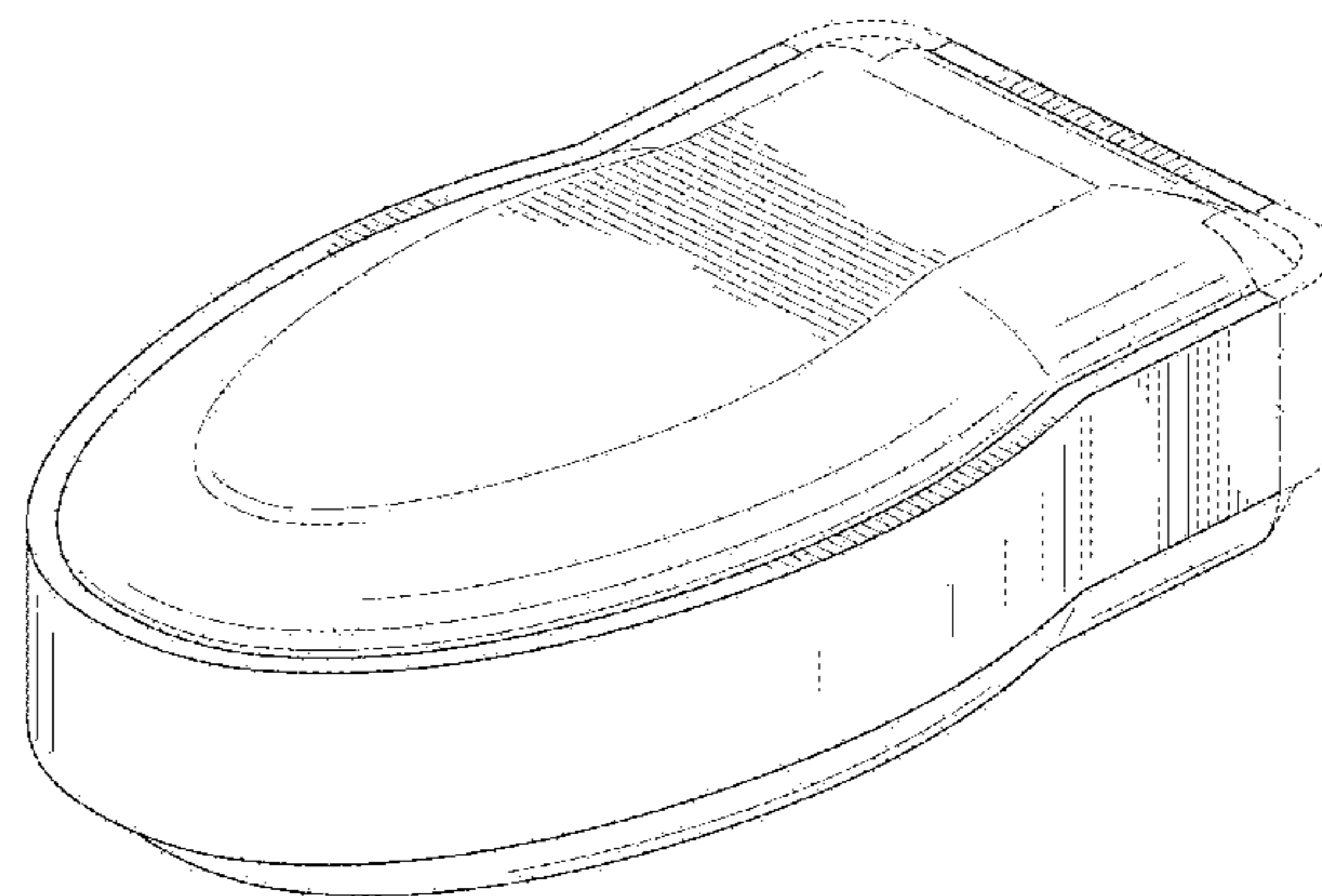
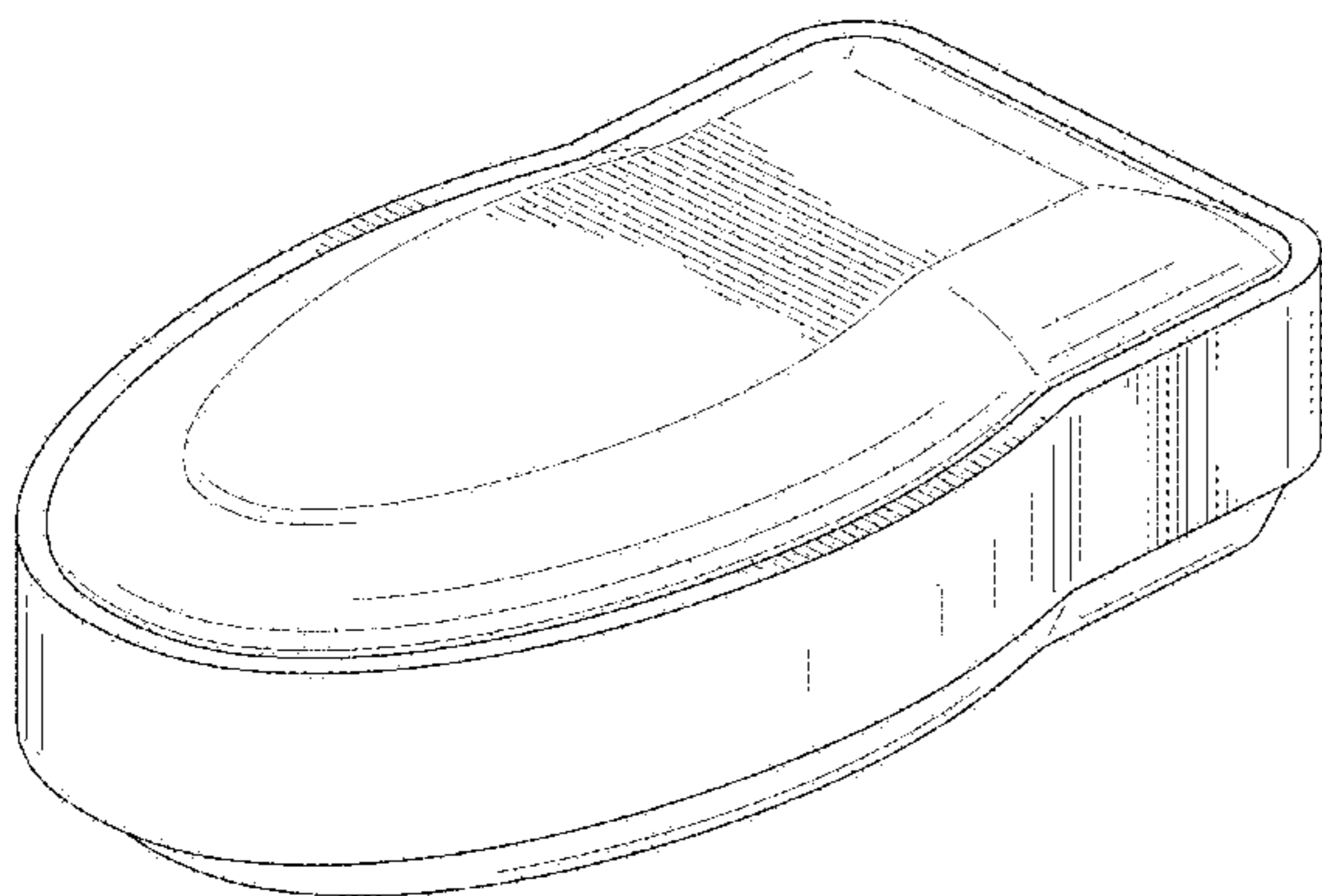

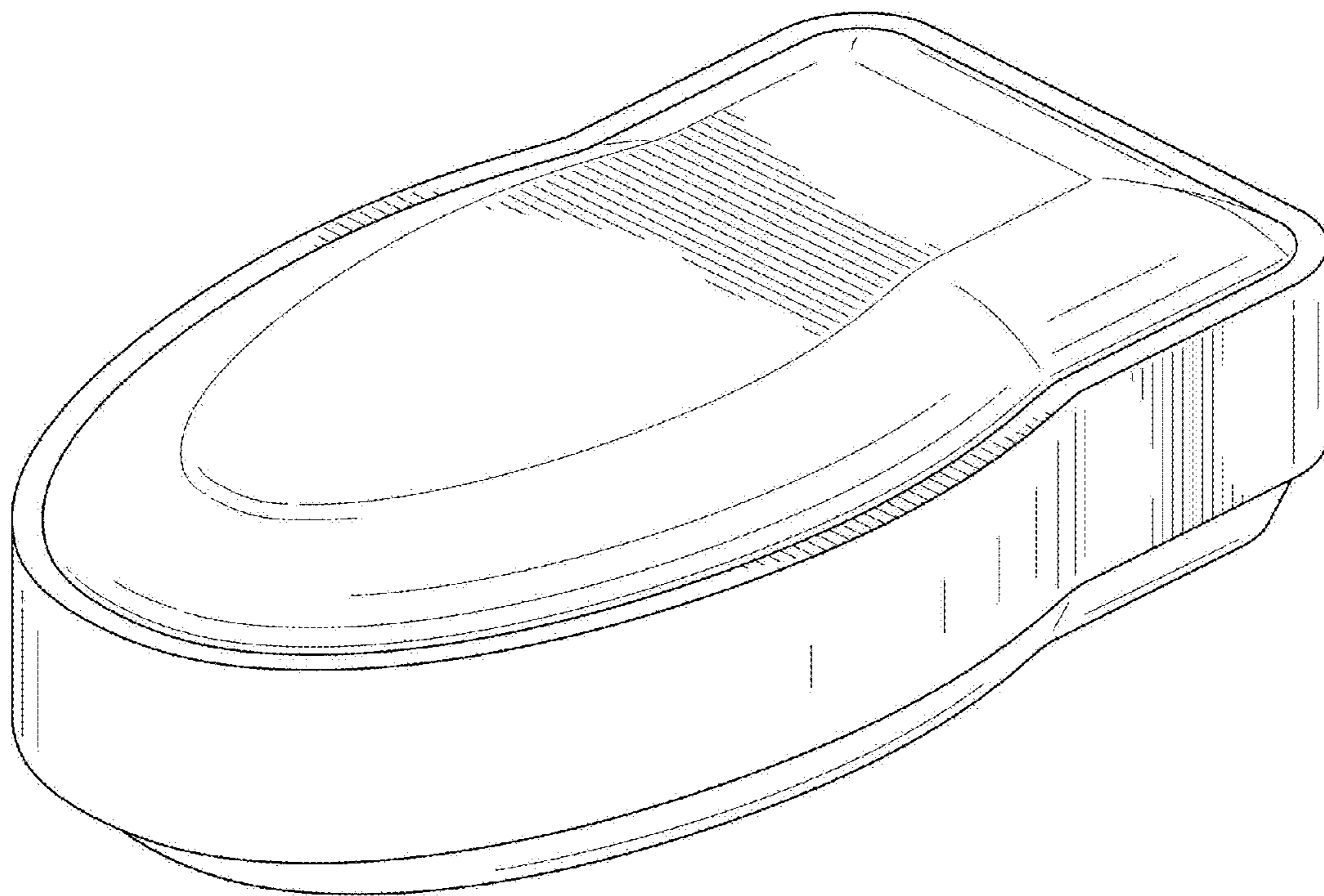

FIG. 1

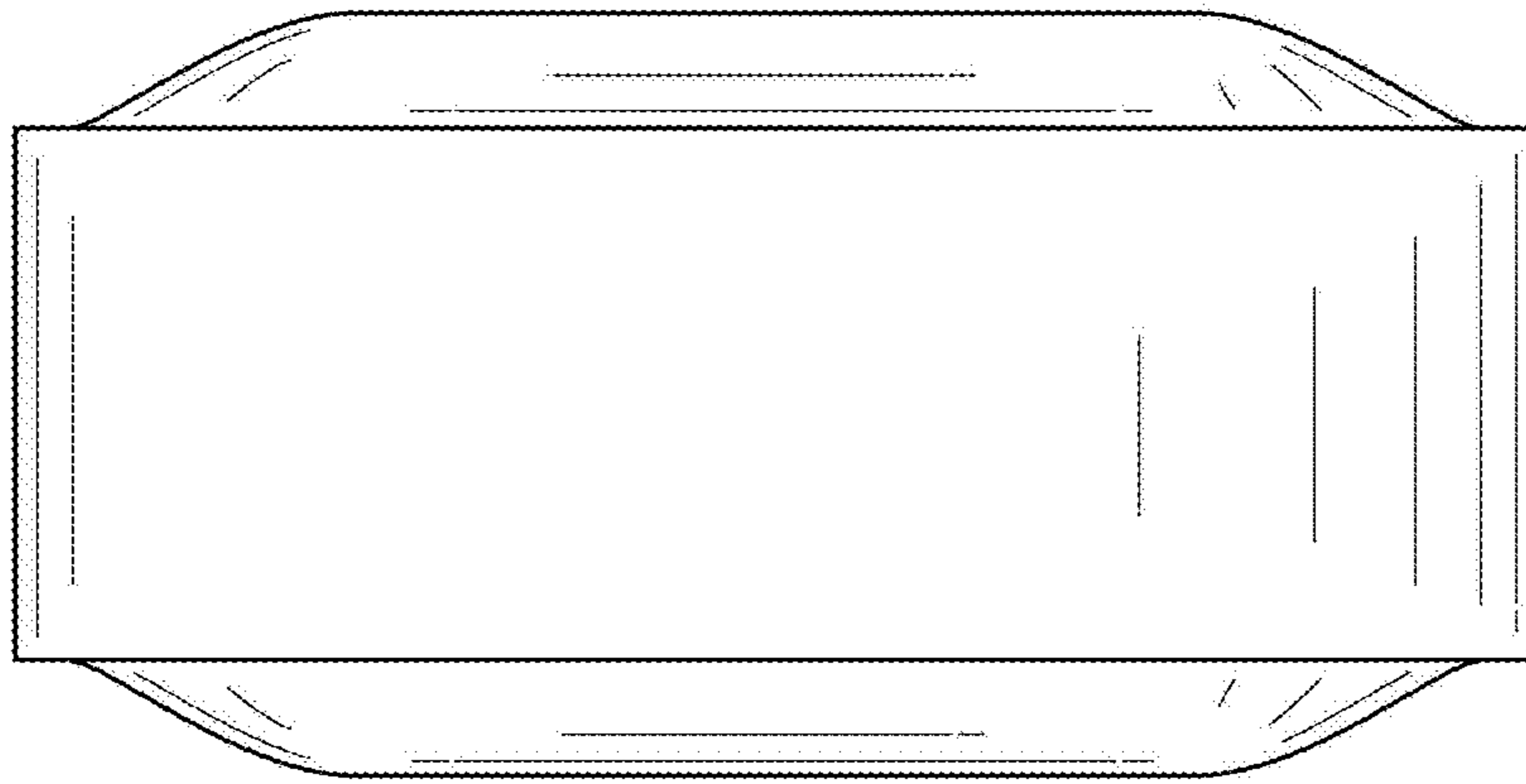

FIG. 2

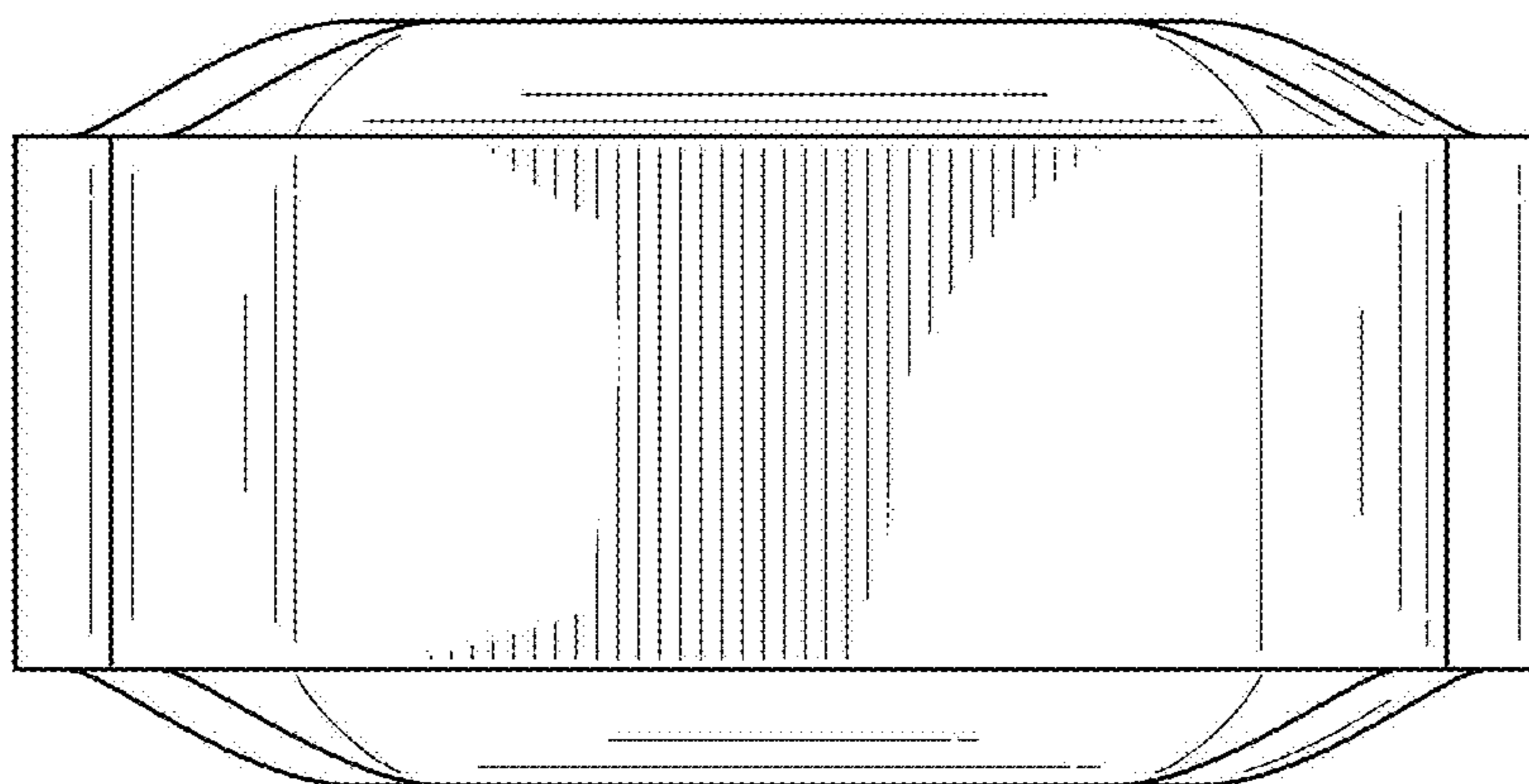

FIG. 3

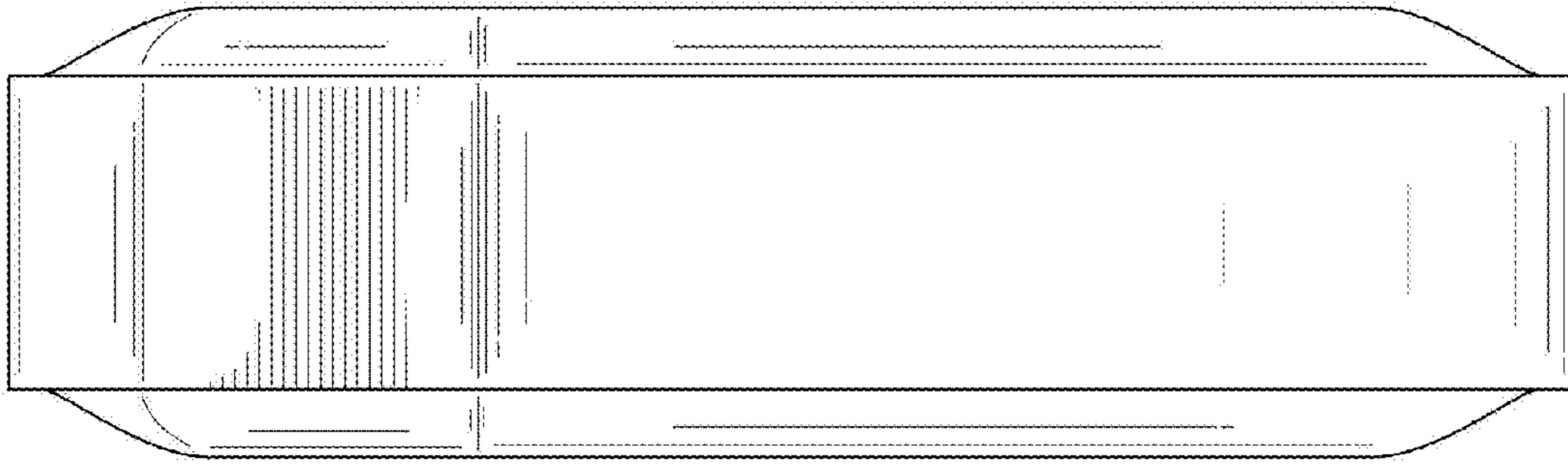

FIG. 4

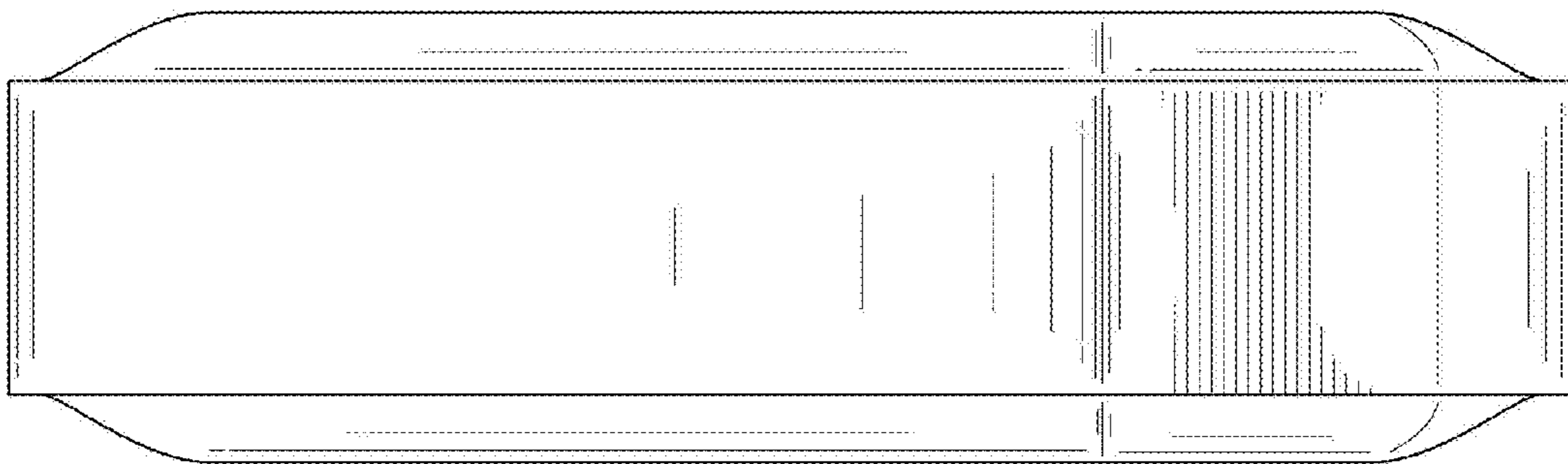

FIG. 5

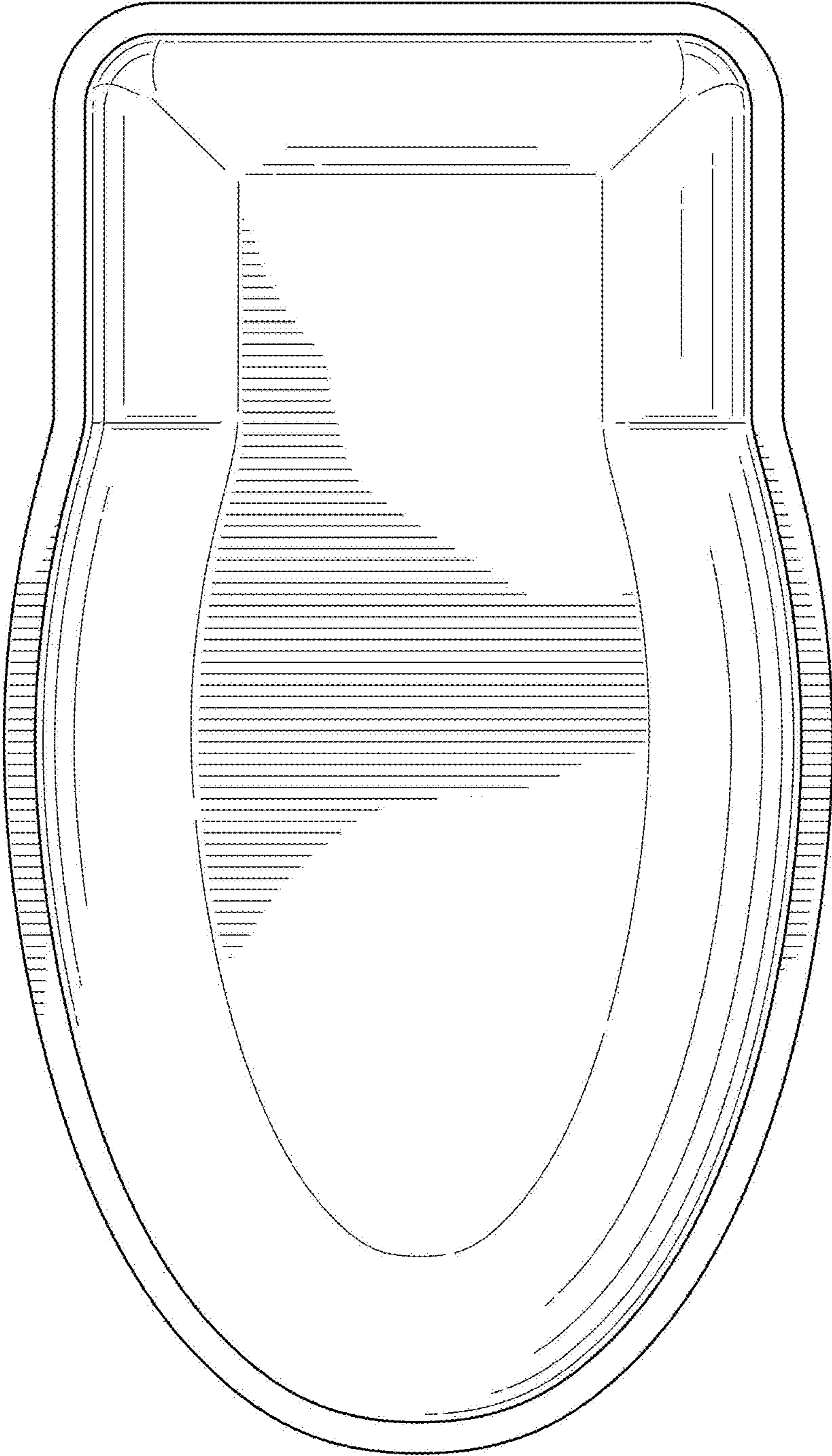

FIG. 6

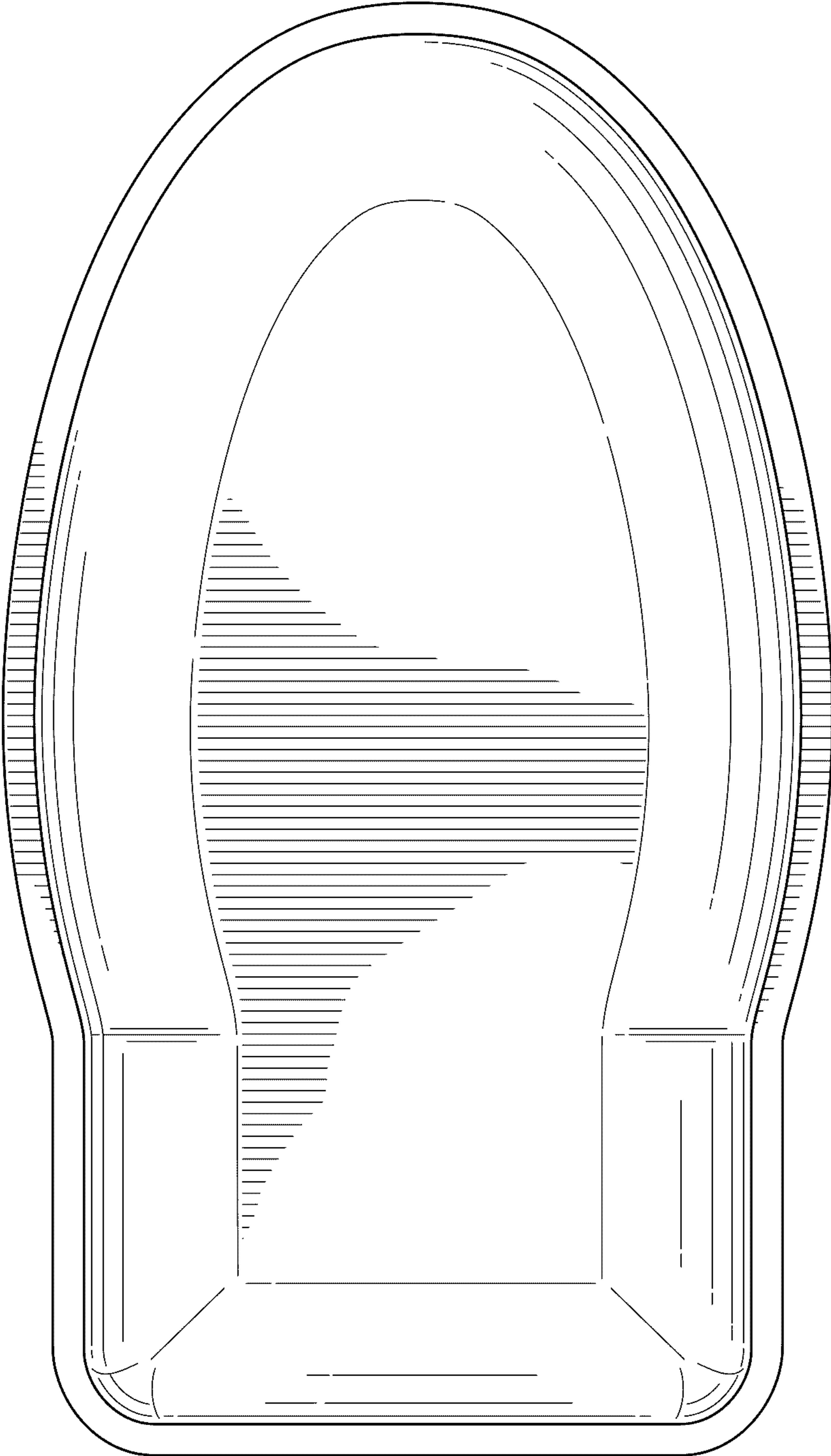

FIG. 7

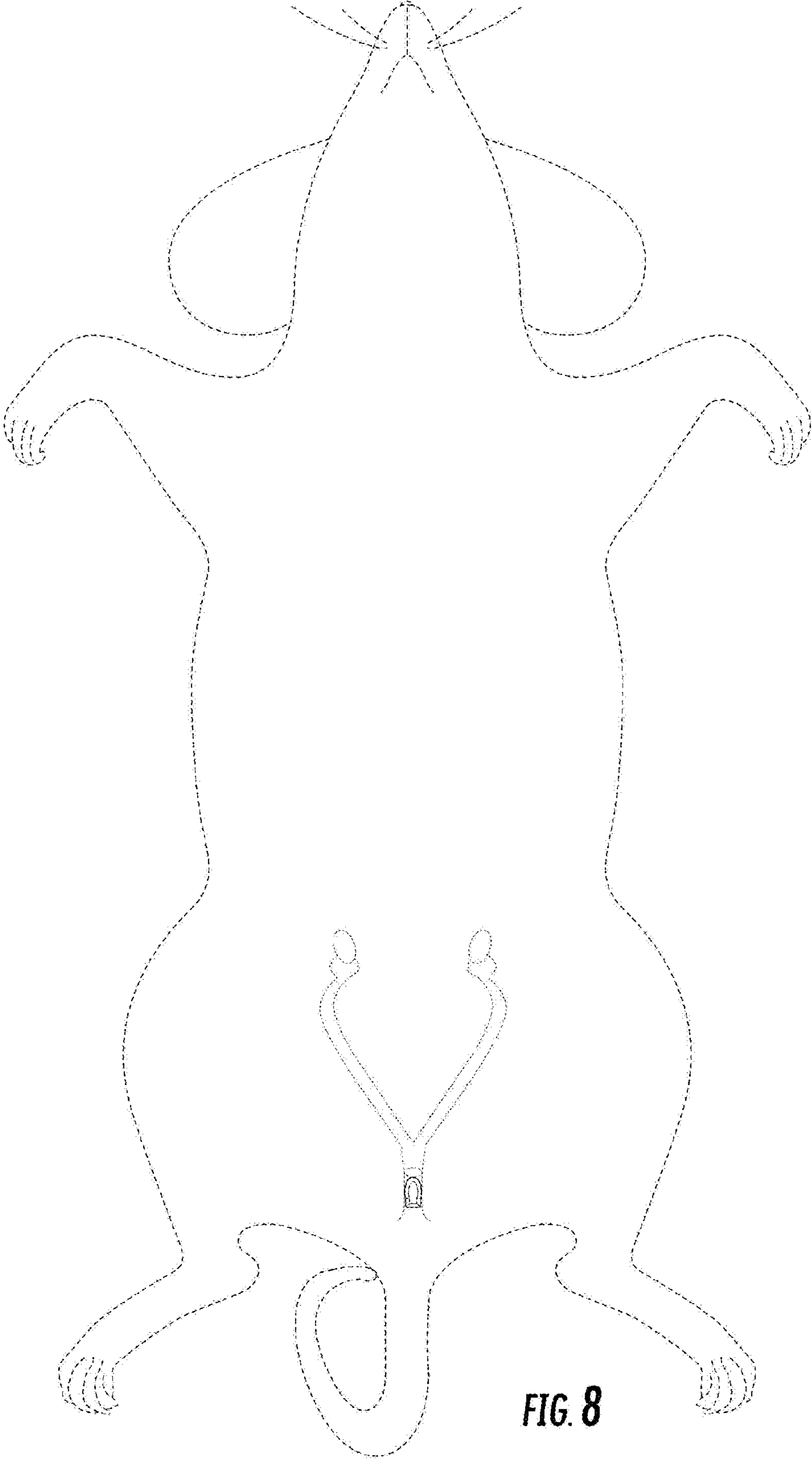

FIG. 8

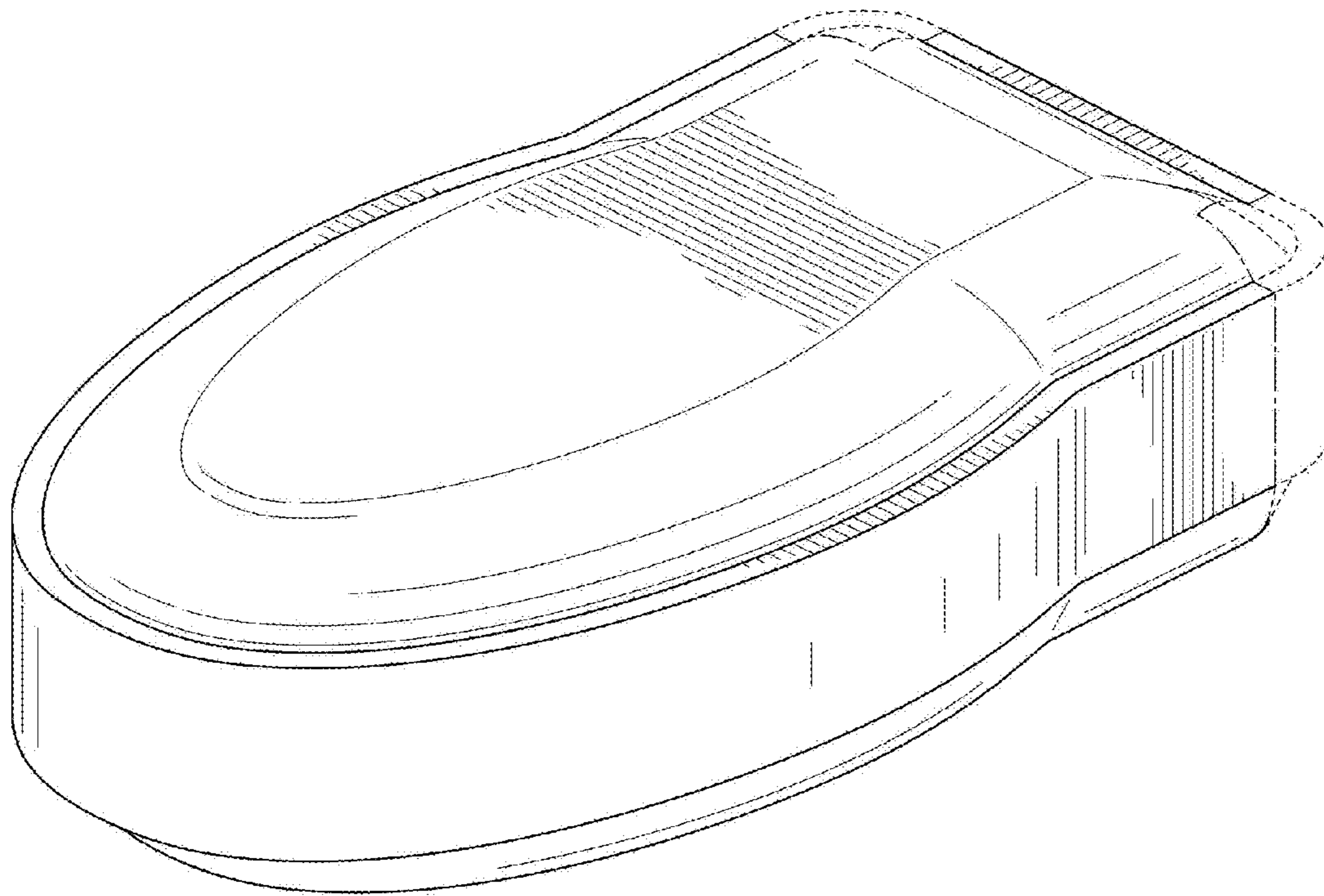

FIG. 9

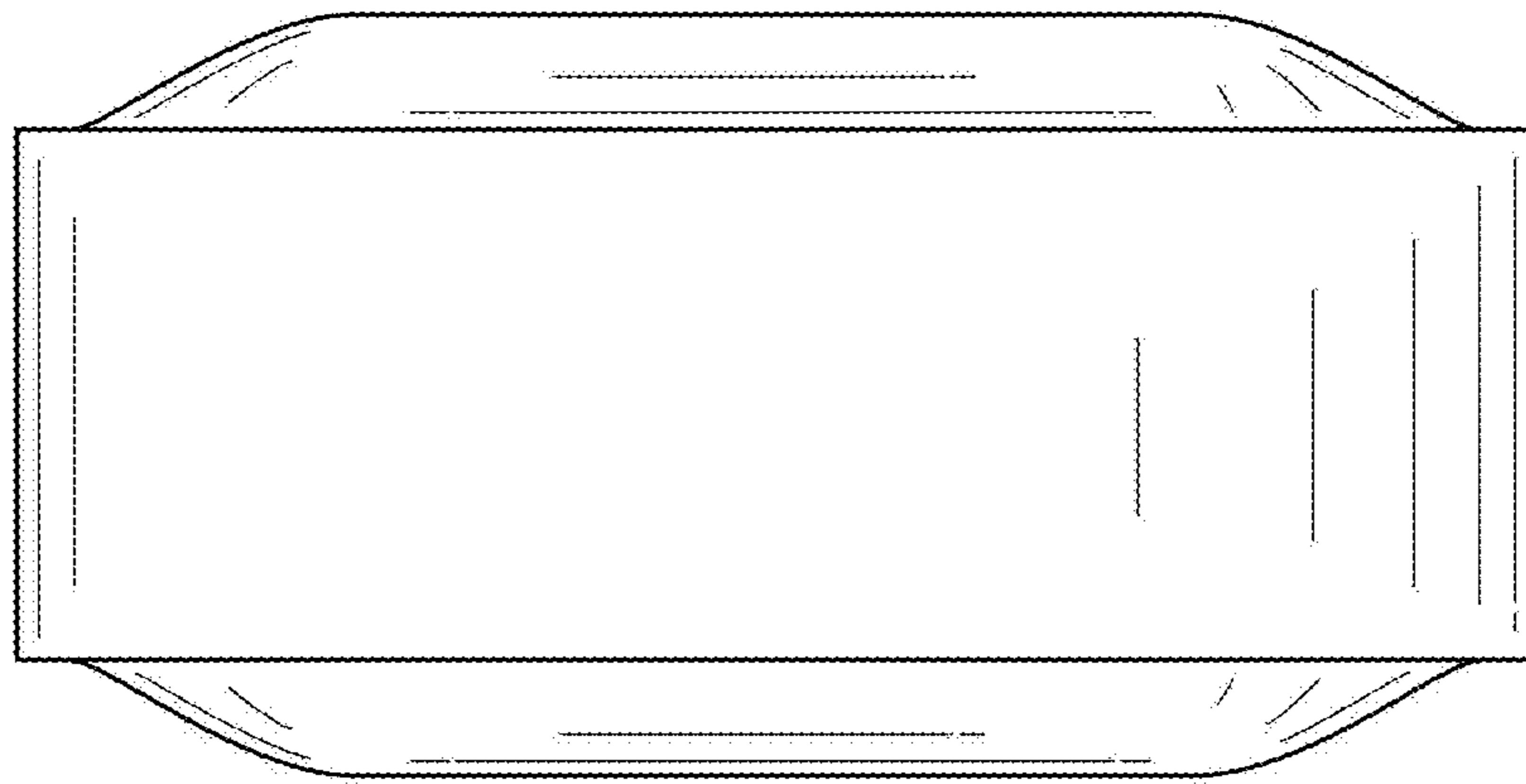

FIG. 10

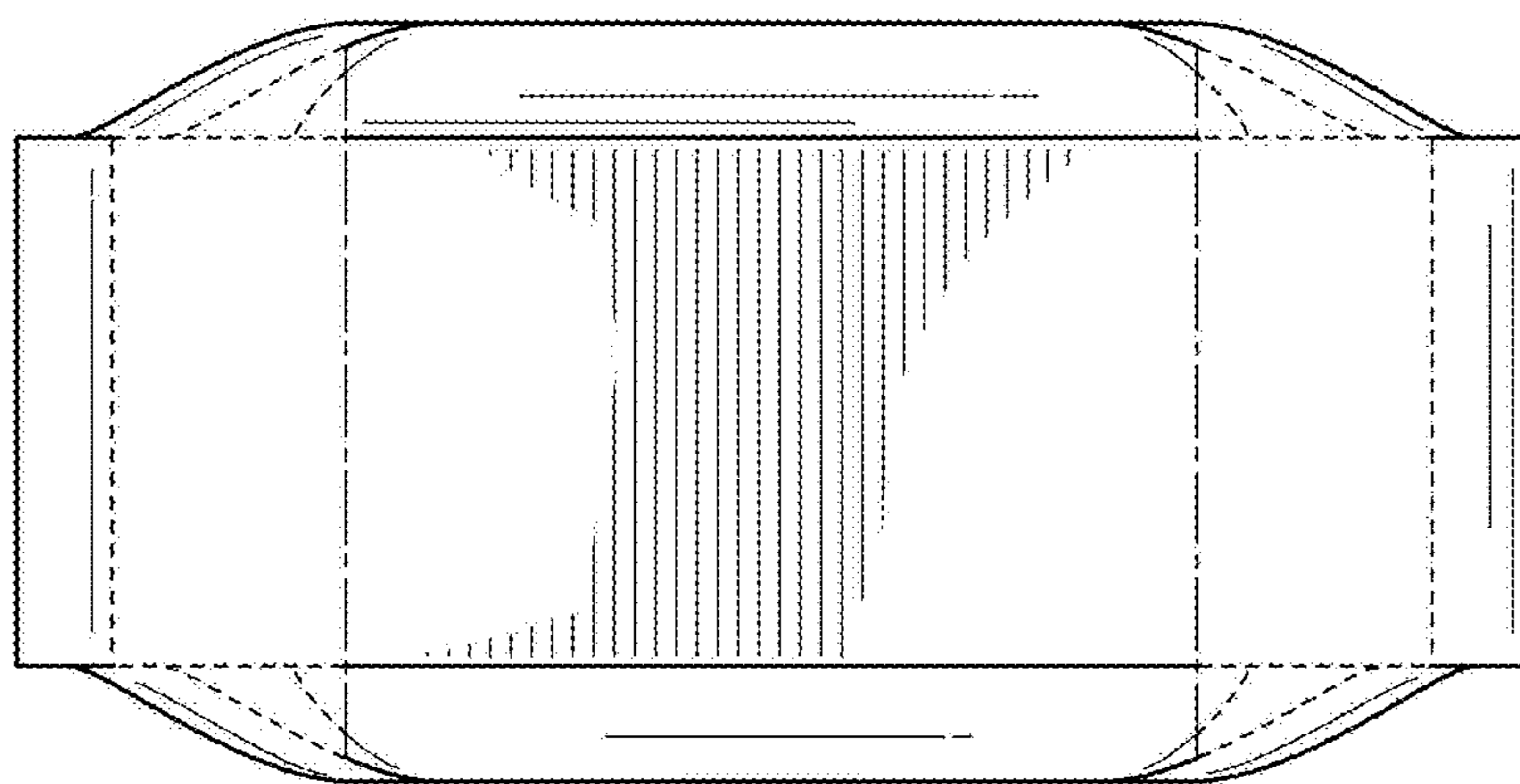

FIG. 11

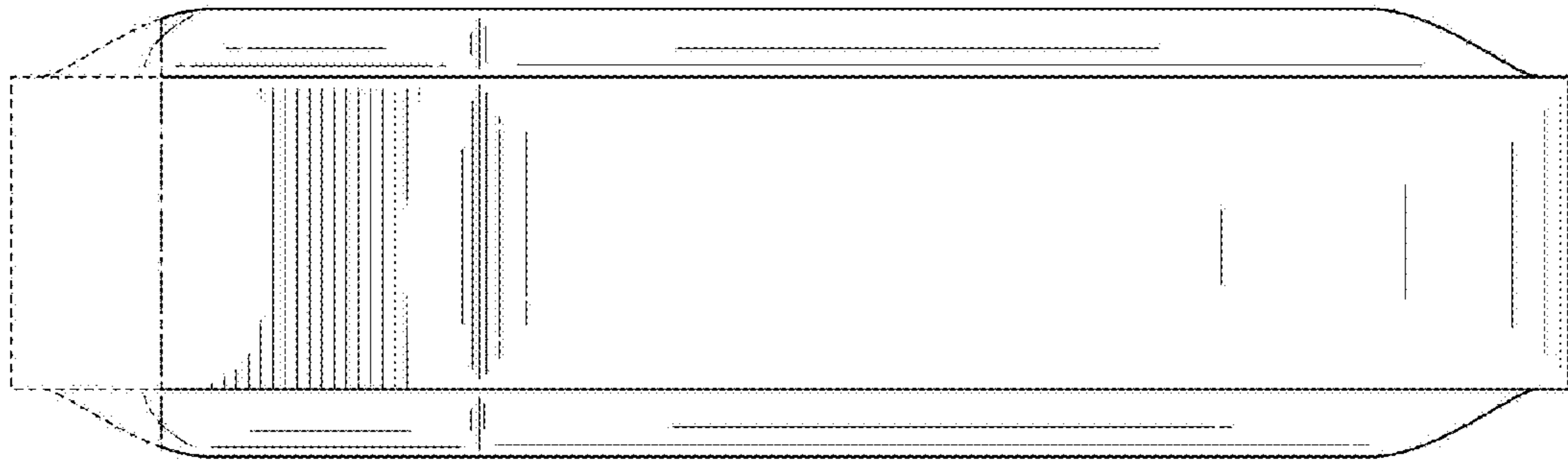

FIG. 12

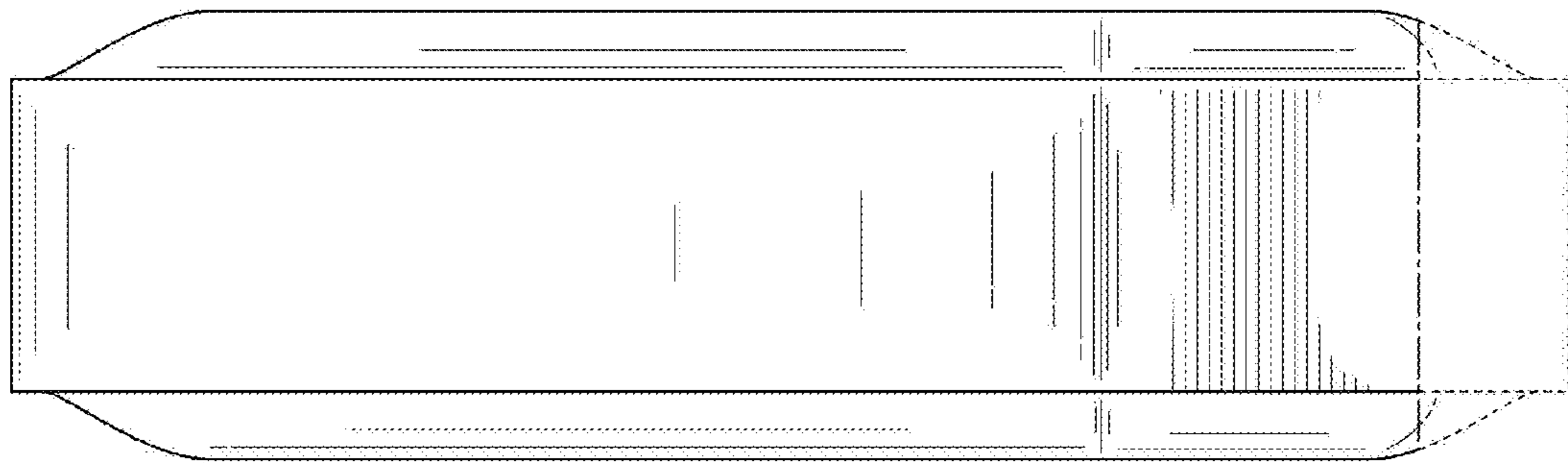

FIG. 13

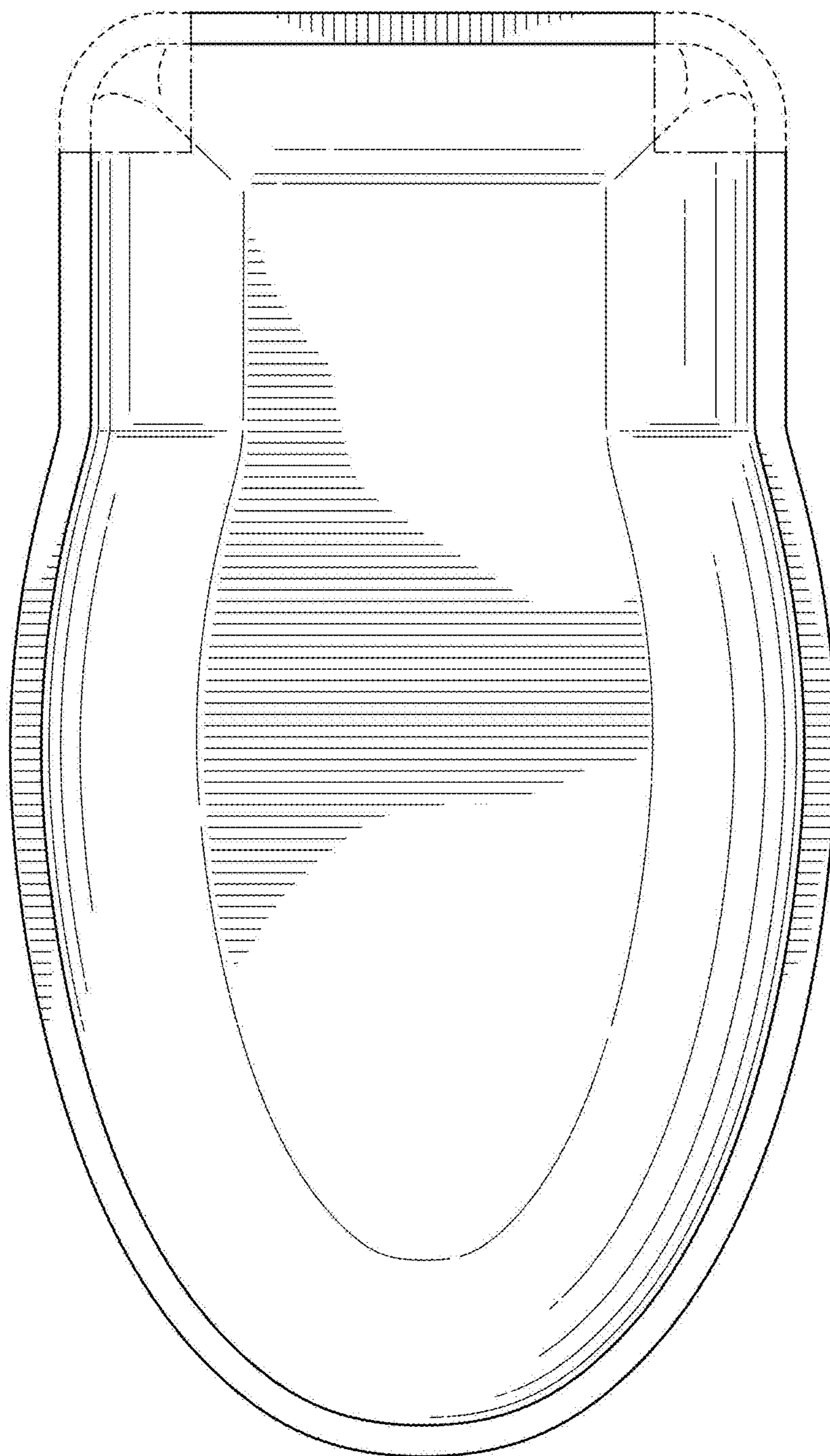

FIG. 14

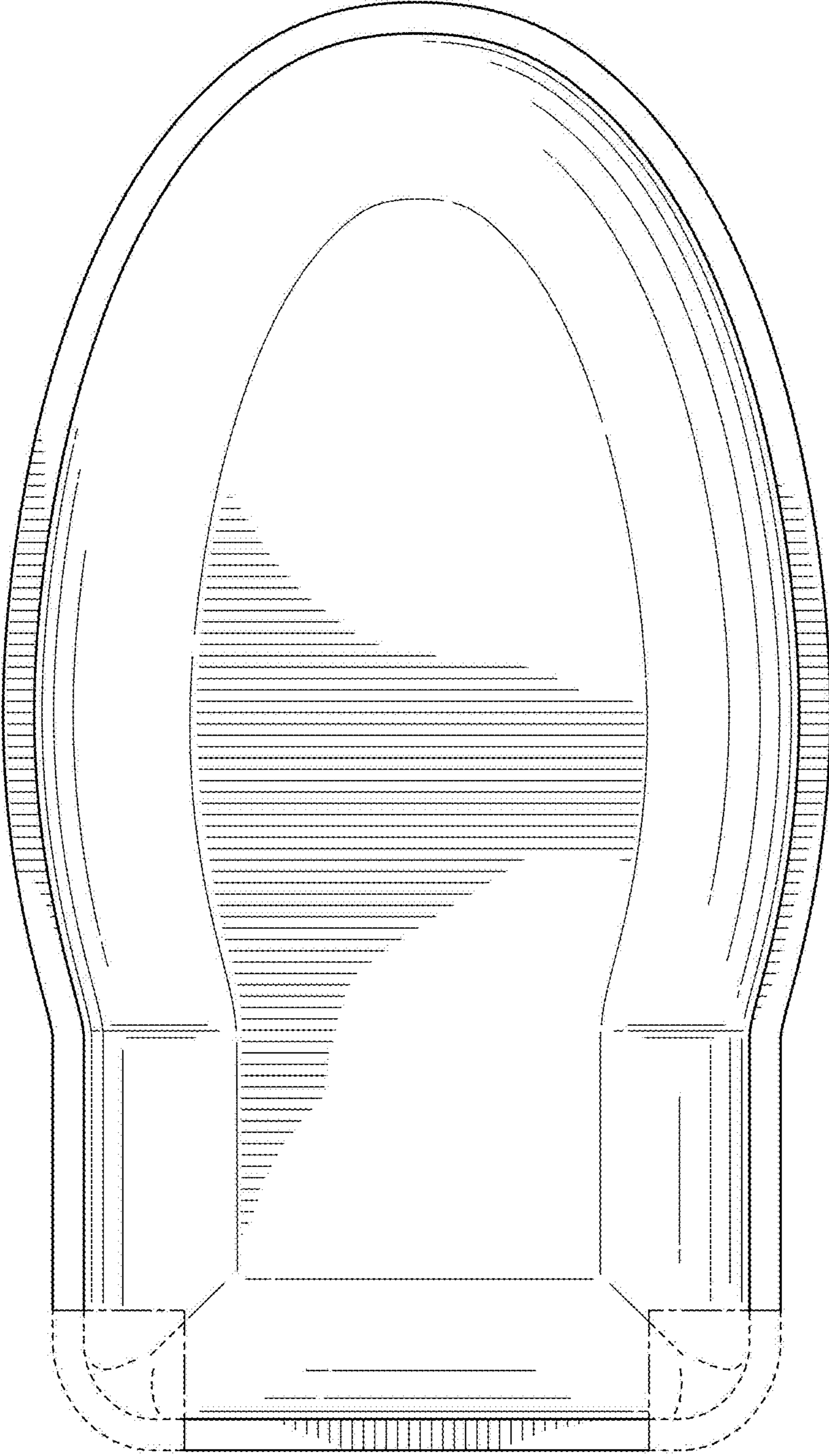

FIG. 15

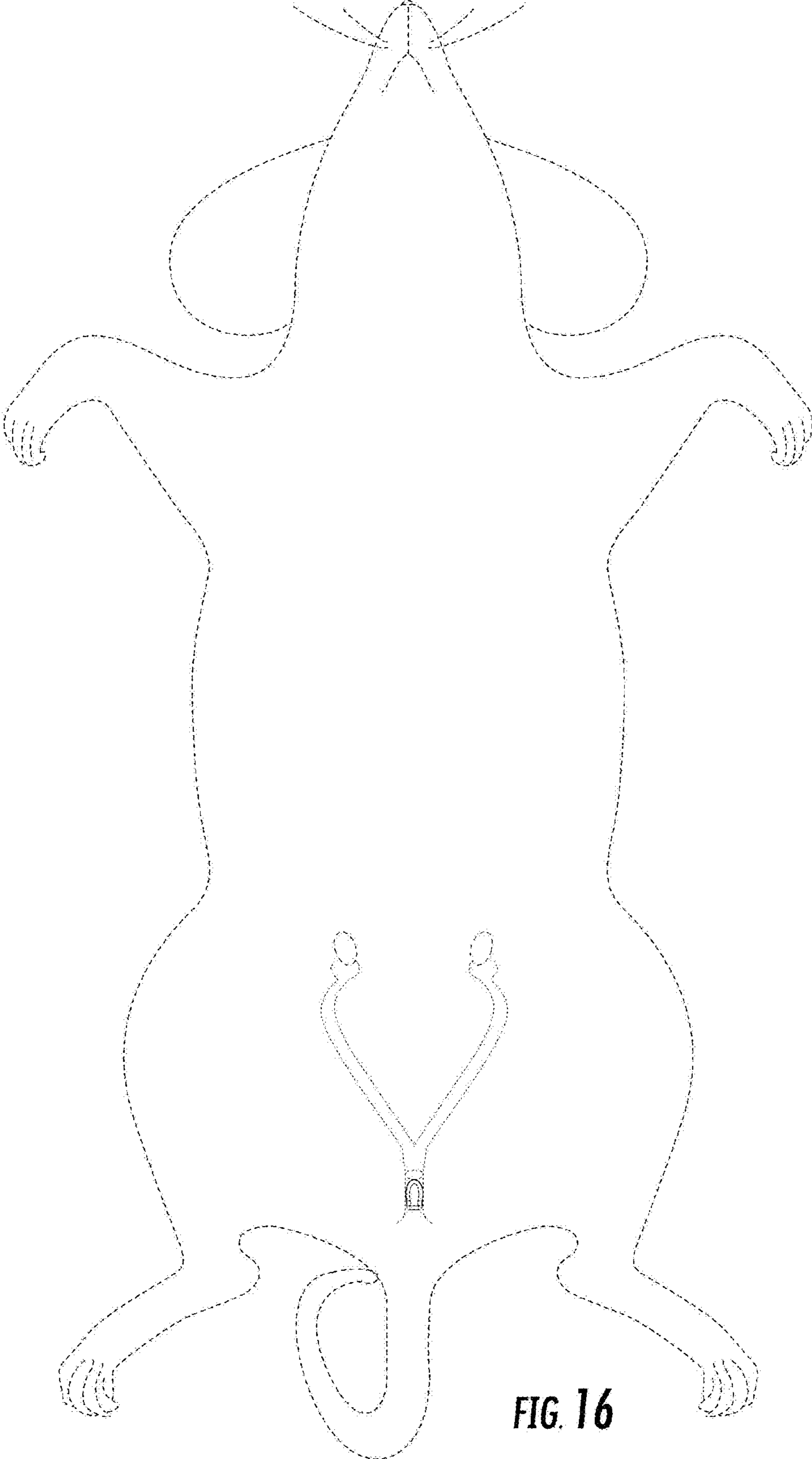

FIG. 16