



US00D771008S

(12) **United States Design Patent** (10) **Patent No.:** **US D771,008 S**
Takahata (45) **Date of Patent:** **** Nov. 8, 2016**

(54) **INTERPHONE MASTER UNIT**
(71) Applicant: **AIPHONE CO., LTD.**, Nagoya (JP)
(72) Inventor: **Kotaro Takahata**, Nagoya (JP)
(73) Assignee: **AIPHONE CO., LTD.**, Nagoya (JP)
(**) Term: **15 Years**
(21) Appl. No.: **29/549,283**
(22) Filed: **Dec. 21, 2015**

D592,083 S * 5/2009 Stevens D10/65
D611,364 S * 3/2010 Lenz D10/65
D630,169 S * 1/2011 Nakai D13/168
D639,266 S * 6/2011 DeLorenzo D14/130
D640,150 S * 6/2011 Hansen D10/65
D646,258 S * 10/2011 Van Der Flier D14/130
D648,233 S * 11/2011 Lenz D10/65
D658,627 S * 5/2012 Katori D14/130
D686,184 S * 7/2013 Takahata D14/151
D694,195 S * 11/2013 Gammon D13/162
D695,735 S * 12/2013 Kitchen D14/341
D696,636 S * 12/2013 Sakai D13/168
D705,093 S * 5/2014 Edgar D10/50
D729,760 S * 5/2015 Takahata D14/159
D748,629 S * 2/2016 Brown D14/383
D761,752 S * 7/2016 Takahata D14/159

(30) **Foreign Application Priority Data**
Jun. 29, 2015 (JP) 2015-014351
(51) **LOC (10) Cl.** **14-03**
(52) **U.S. Cl.**
USPC **D14/159**
(58) **Field of Classification Search**
USPC D14/315-327, 384, 432, 439-446, 341,
D14/345, 353-355, 125, 130, 132, 138,
D14/159; D16/202, 208; D9/424-432;
D6/491; D8/403; 235/145 A, 145 R;
341/22, 23; 349/12; 361/680-686;
D20/10, 41, 43
CPC G08B 13/1672; G08B 13/19645;
G08B 25/006; H04M 11/04
See application file for complete search history.

* cited by examiner

Primary Examiner — Austin Murphy
(74) *Attorney, Agent, or Firm* — Burr & Brown, PLLC

(57) **CLAIM**
The ornamental design for an interphone master unit, as shown and described.

DESCRIPTION

FIG. 1 is front view of an interphone master unit illustrating my new design;
FIG. 2 is a rear view thereof;
FIG. 3 is a left side view thereof;
FIG. 4 is a right side view thereof;
FIG. 5 is a top plan view thereof;
FIG. 6 is a bottom plan view thereof; and,
FIG. 7 is a front perspective view thereof.
The broken lines shown in the drawings represent portions of the interphone master unit that form no part of the claimed design.

(56) **References Cited**
U.S. PATENT DOCUMENTS
D514,558 S * 2/2006 Nagel D14/341
D571,235 S * 6/2008 Stevens D10/65
D582,802 S * 12/2008 Branson D10/50

1 Claim, 7 Drawing Sheets

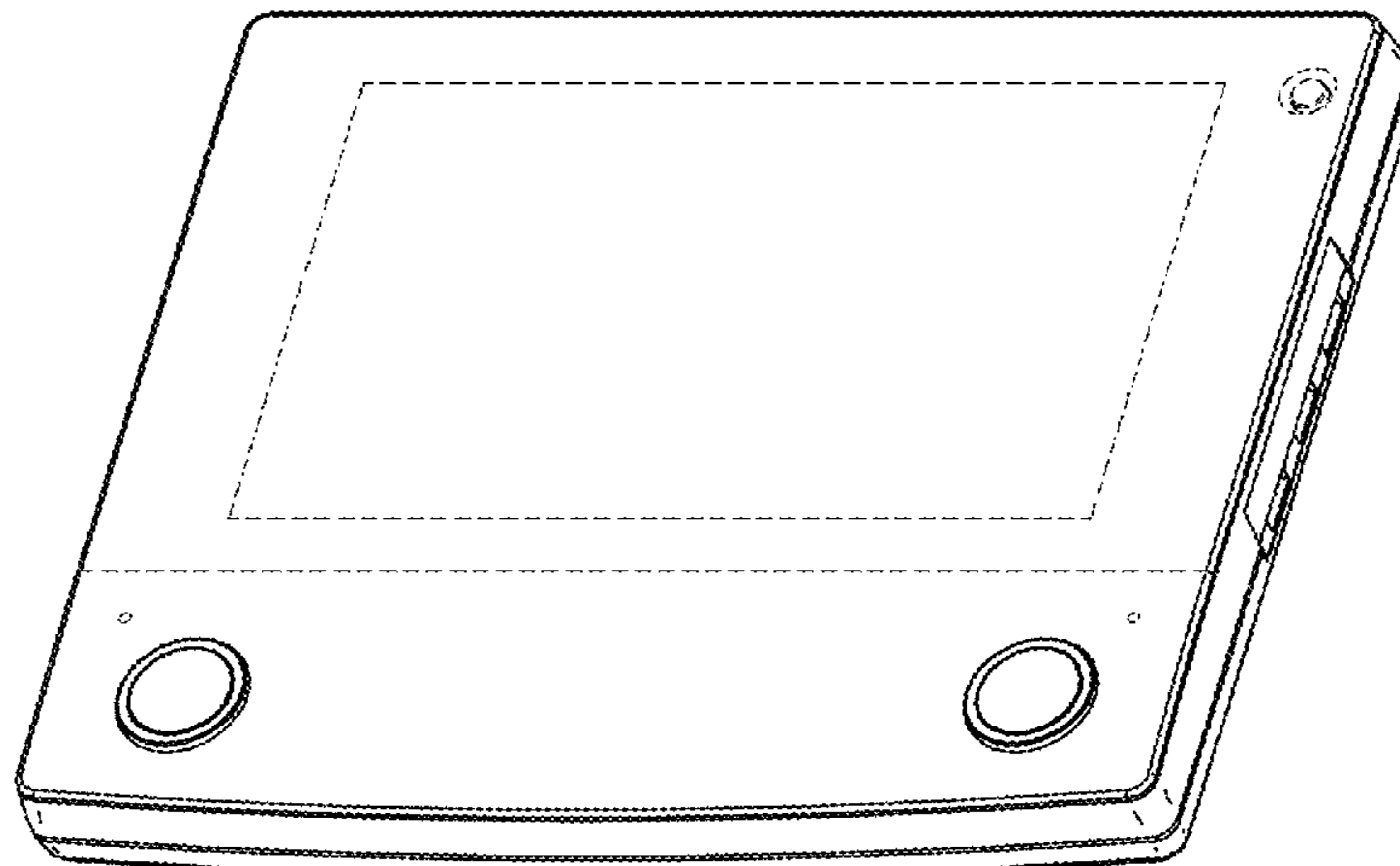
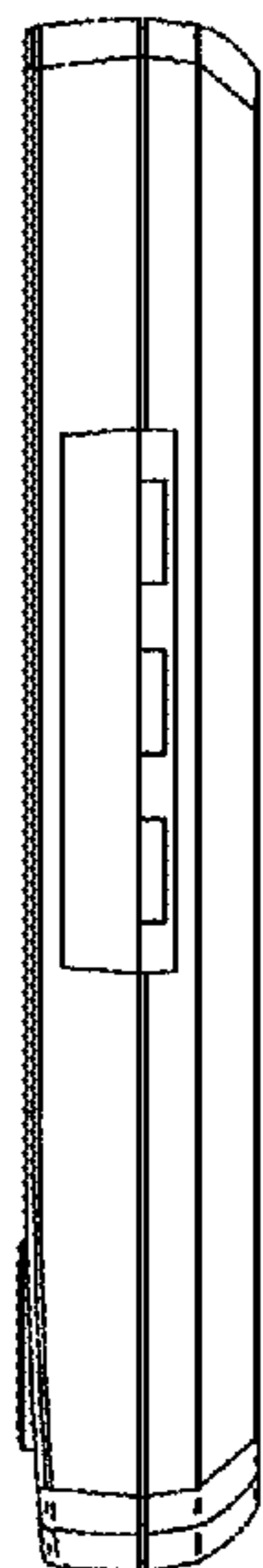

Fig.1

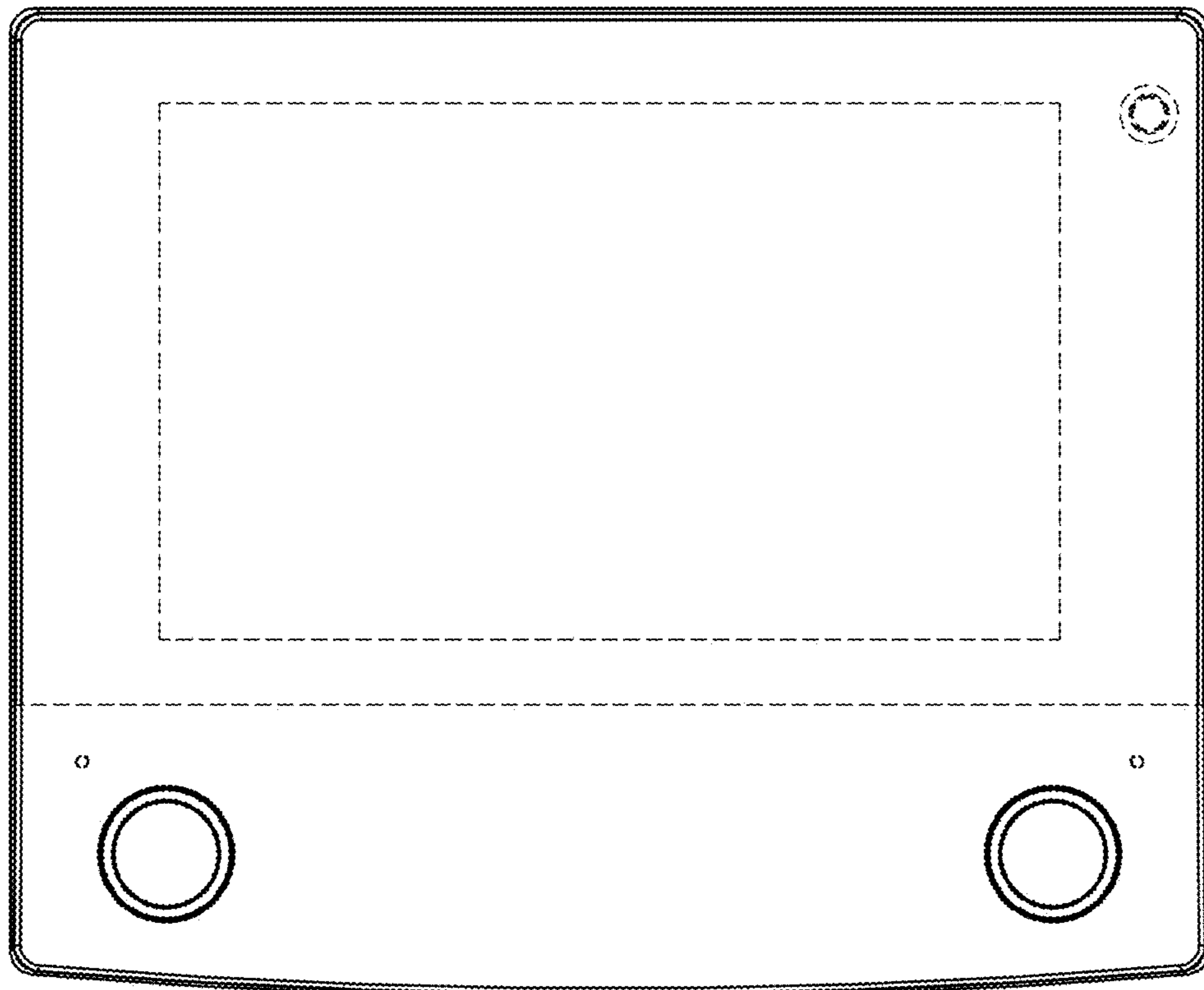

Fig.2

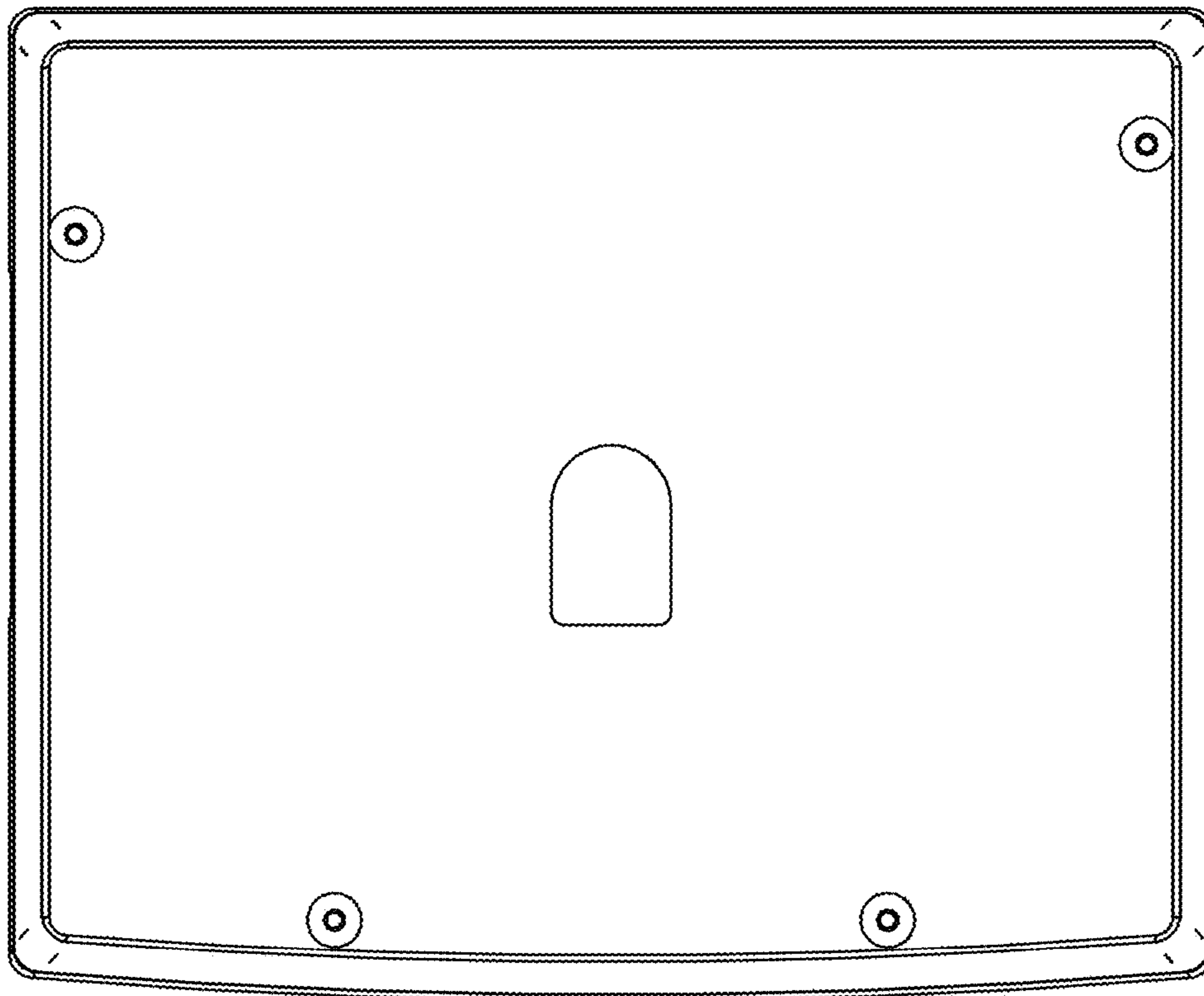

Fig.3

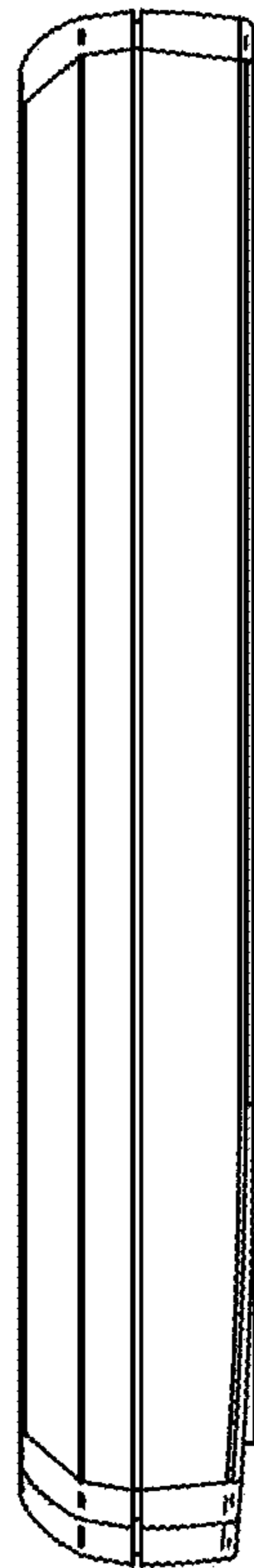

Fig.4

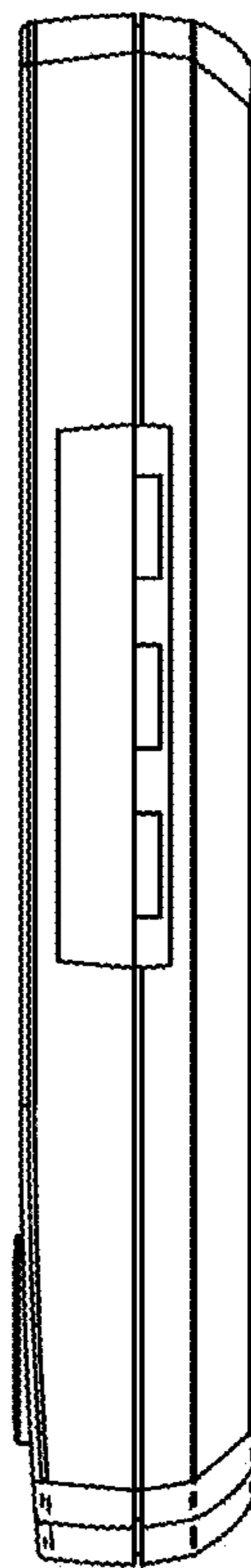

Fig.5

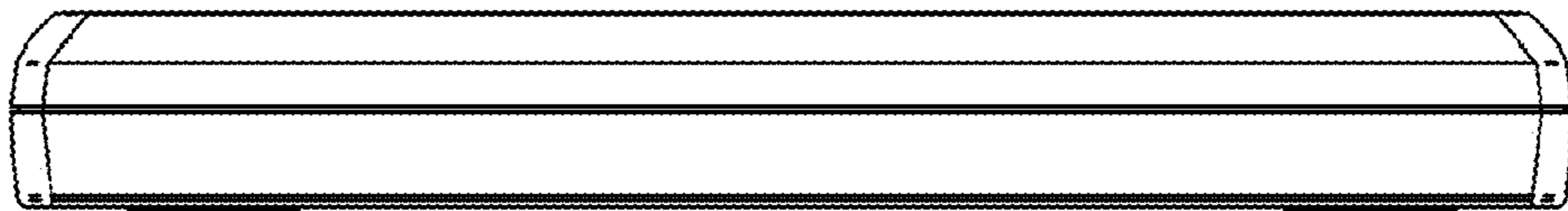

Fig.6

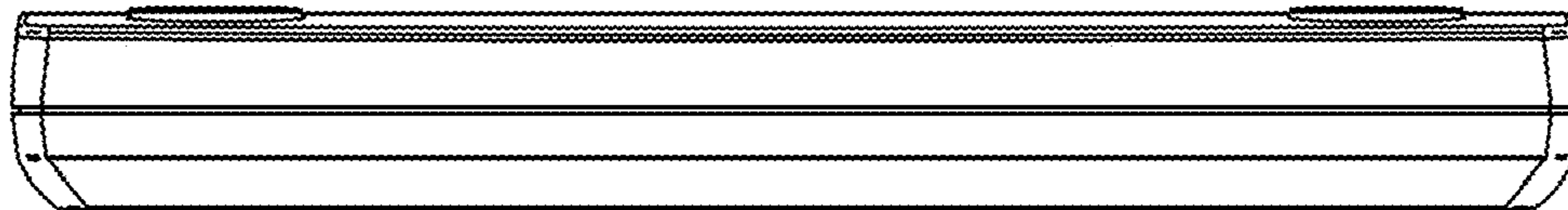

Fig.7

