



US00D770916S

(12) **United States Design Patent** (10) **Patent No.:** **US D770,916 S**
Nouri et al. (45) **Date of Patent:** **** Nov. 8, 2016**

(54) **SILICONE BAG**

(71) Applicant: **Modern Twist, Inc.**, Emeryville, CA (US)

(72) Inventors: **Katousha Ghaemi Nouri**, Emeryville, CA (US); **Paul Maguire**, Emeryville, CA (US)

(73) Assignee: **MODERN TWIST, INC.**, Emeryville, CA (US)

(**) Term: **14 Years**

(21) Appl. No.: **29/525,638**

(22) Filed: **Apr. 30, 2015**

(51) **LOC (10) Cl.** **09-05**

(52) **U.S. Cl.**
USPC **D9/709**

(58) **Field of Classification Search**
USPC D9/702, 707, 709, 710
CPC B65D 33/25; B65D 33/255; B65D 33/00;
B65D 33/2508; B65D 31/00
See application file for complete search history.

(56) **References Cited**

U.S. PATENT DOCUMENTS

3,338,285 A 8/1967 Jaster et al.
D323,979 S * 2/1992 Forman D9/709
D512,650 S * 12/2005 Dapsance D9/707

D724,441 S * 3/2015 Fukuda D9/707
2006/0034551 A1 2/2006 Linneweil
2007/0095848 A1 5/2007 Galland et al.
2007/0183692 A1 8/2007 Pawloski
2009/0110335 A1 4/2009 LeBoeuf
2011/0038564 A1 2/2011 Slansky
2011/0268373 A1* 11/2011 Polland B65D 33/2508
383/65
2012/0008880 A1 1/2012 Toth
2012/0106874 A1 5/2012 Pawloski
2014/0270587 A1 9/2014 Schreiter et al.

* cited by examiner

Primary Examiner — Terry Wallace

(74) *Attorney, Agent, or Firm* — Arc IP Law, PC; Joseph J. Mayo

(57) **CLAIM**

The ornamental design for a silicone bag, as shown and described.

DESCRIPTION

FIG. 1 is a front upper perspective view of a silicone bag. FIG. 2 is a bottom lower perspective view of the silicone bag of FIG. 1.

FIG. 3 is a front view of the silicone bag of FIG. 1.

FIG. 4 is a back view of the silicone bag of FIG. 1.

FIG. 5 is a right side view of the silicone bag of FIG. 1 of which the left side is a minor image.

FIG. 6 is a top view of the silicone bag of FIG. 1; and,

FIG. 7 is a bottom view of the silicone bag of FIG. 1.

1 Claim, 7 Drawing Sheets

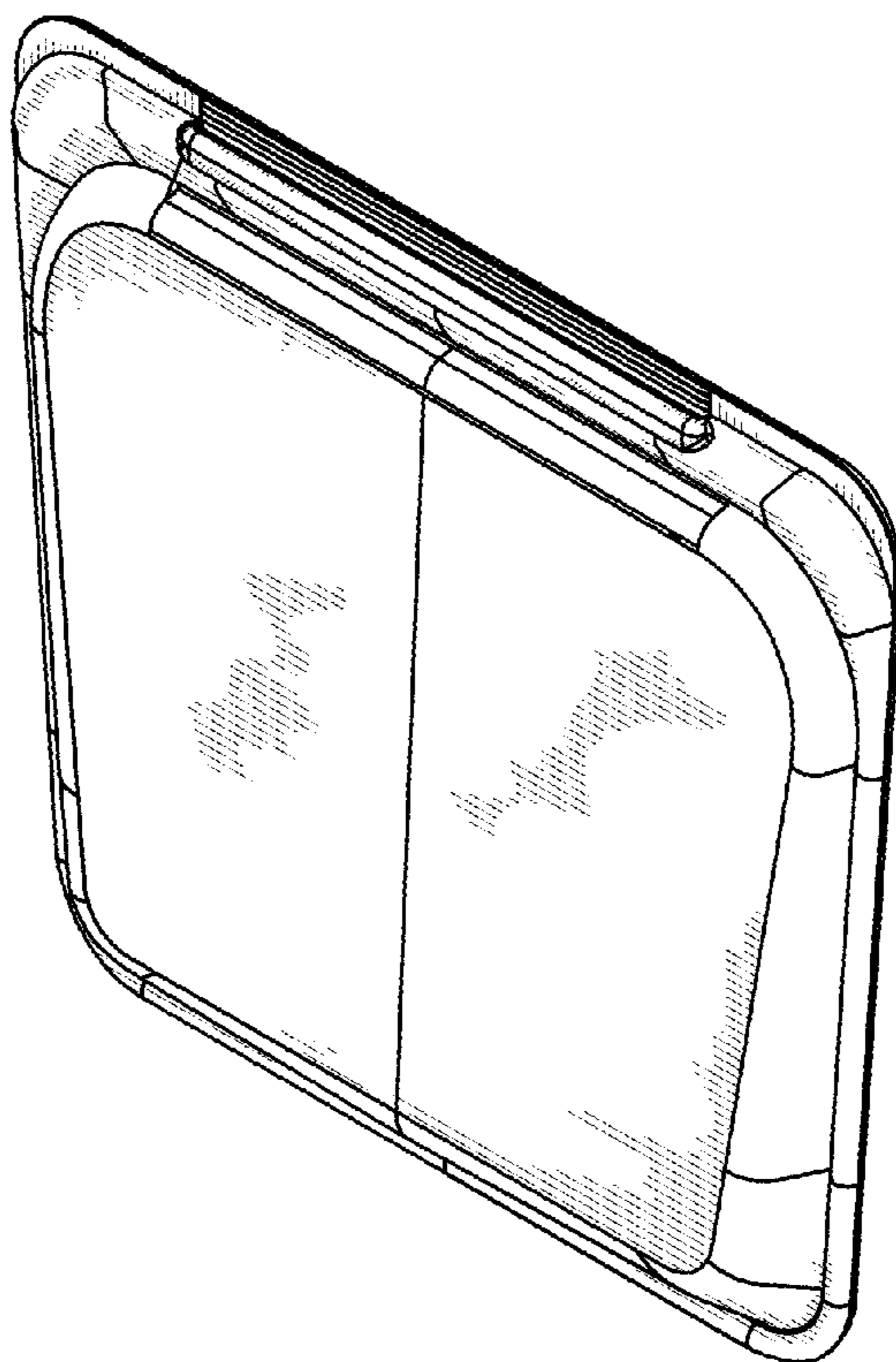

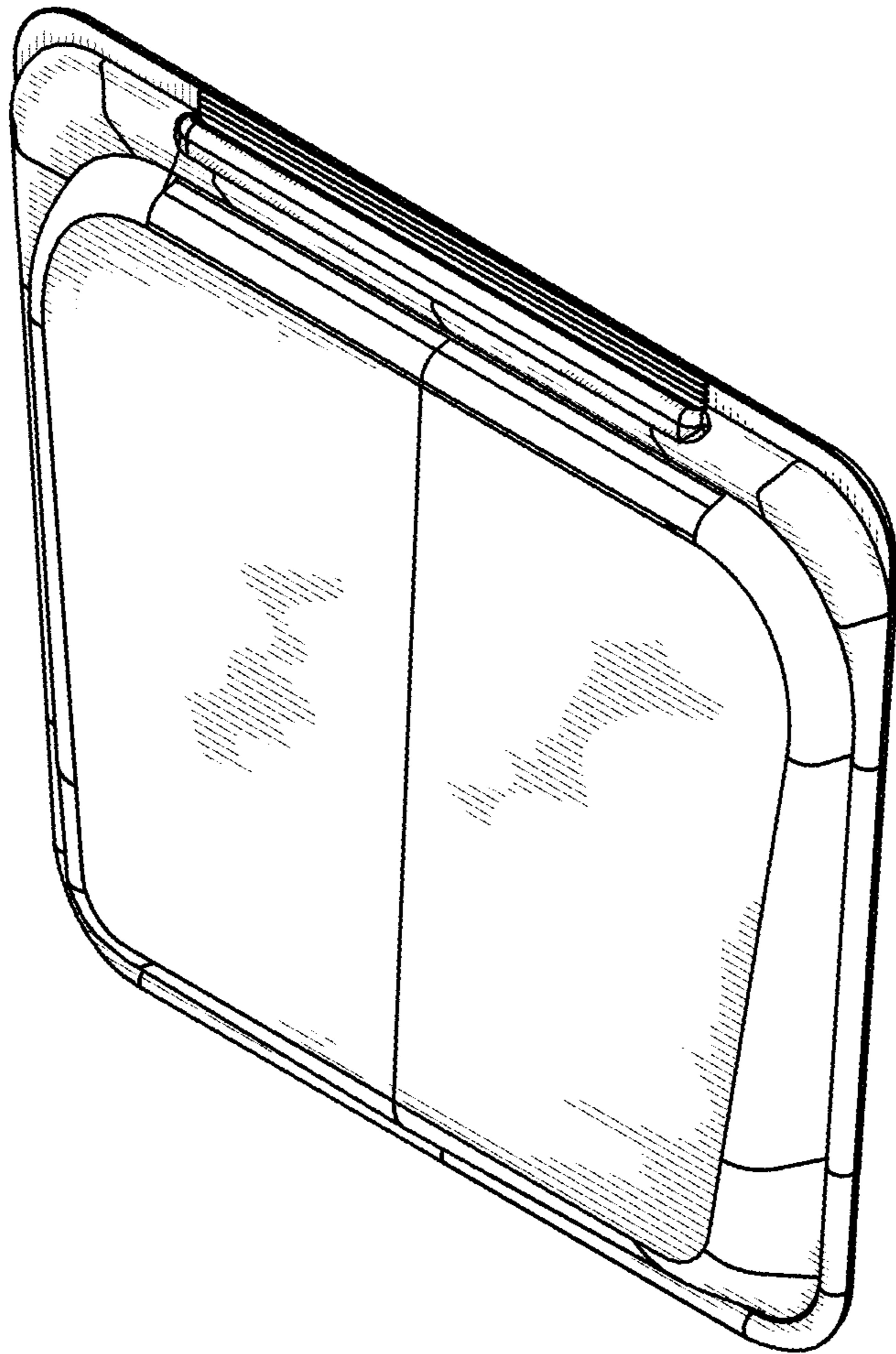

FIG. 1

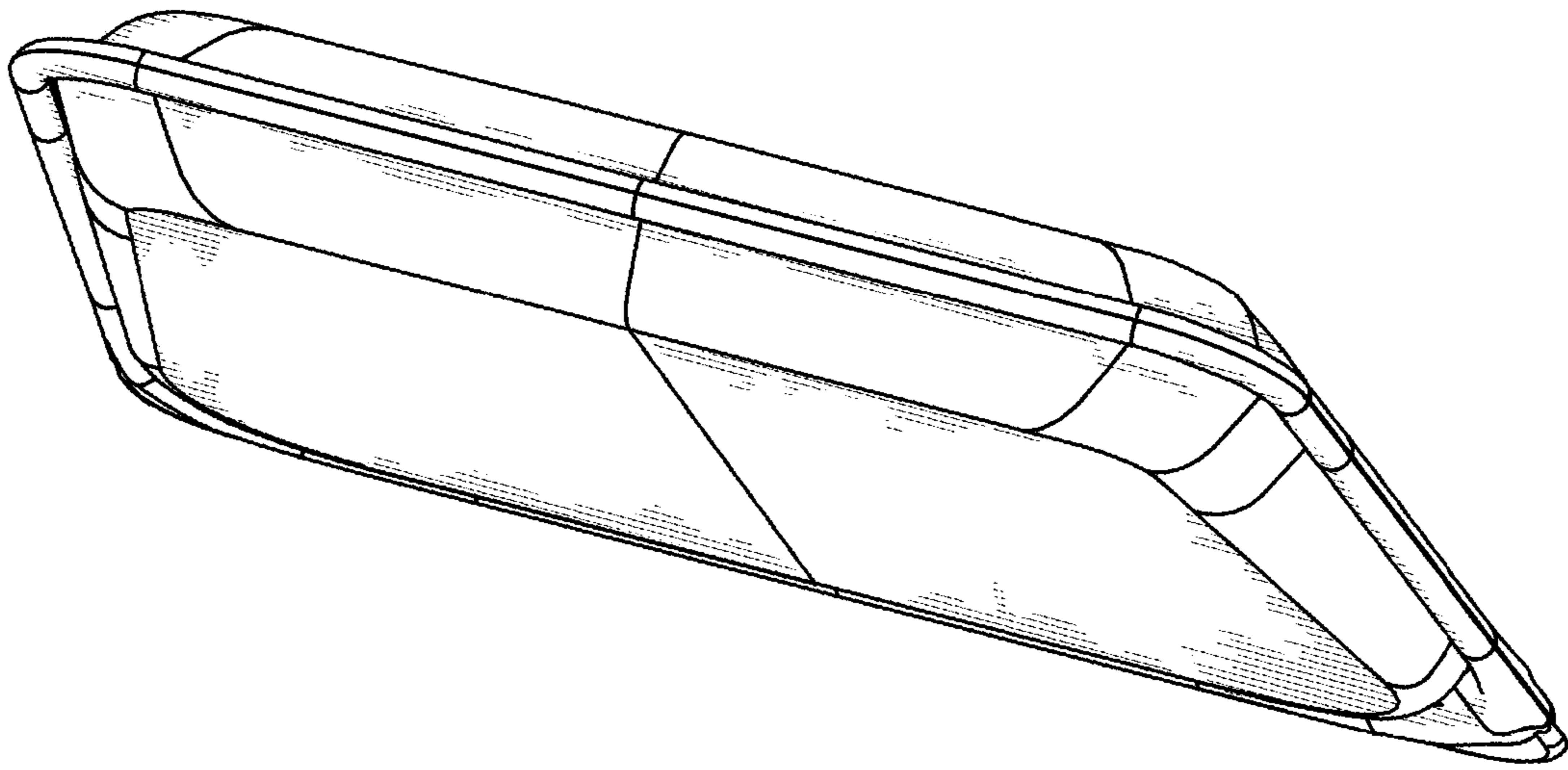

FIG. 2

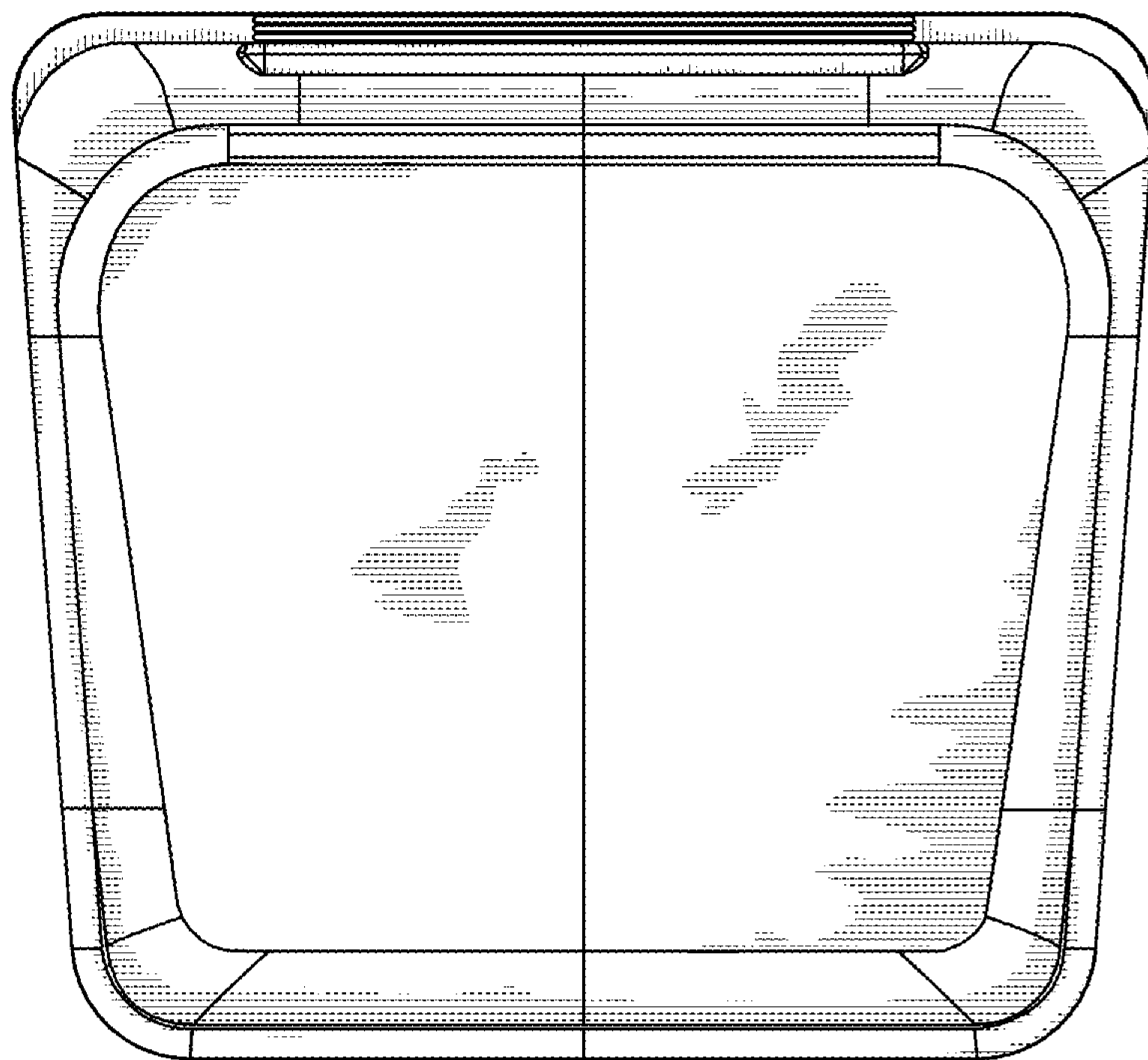

FIG. 3

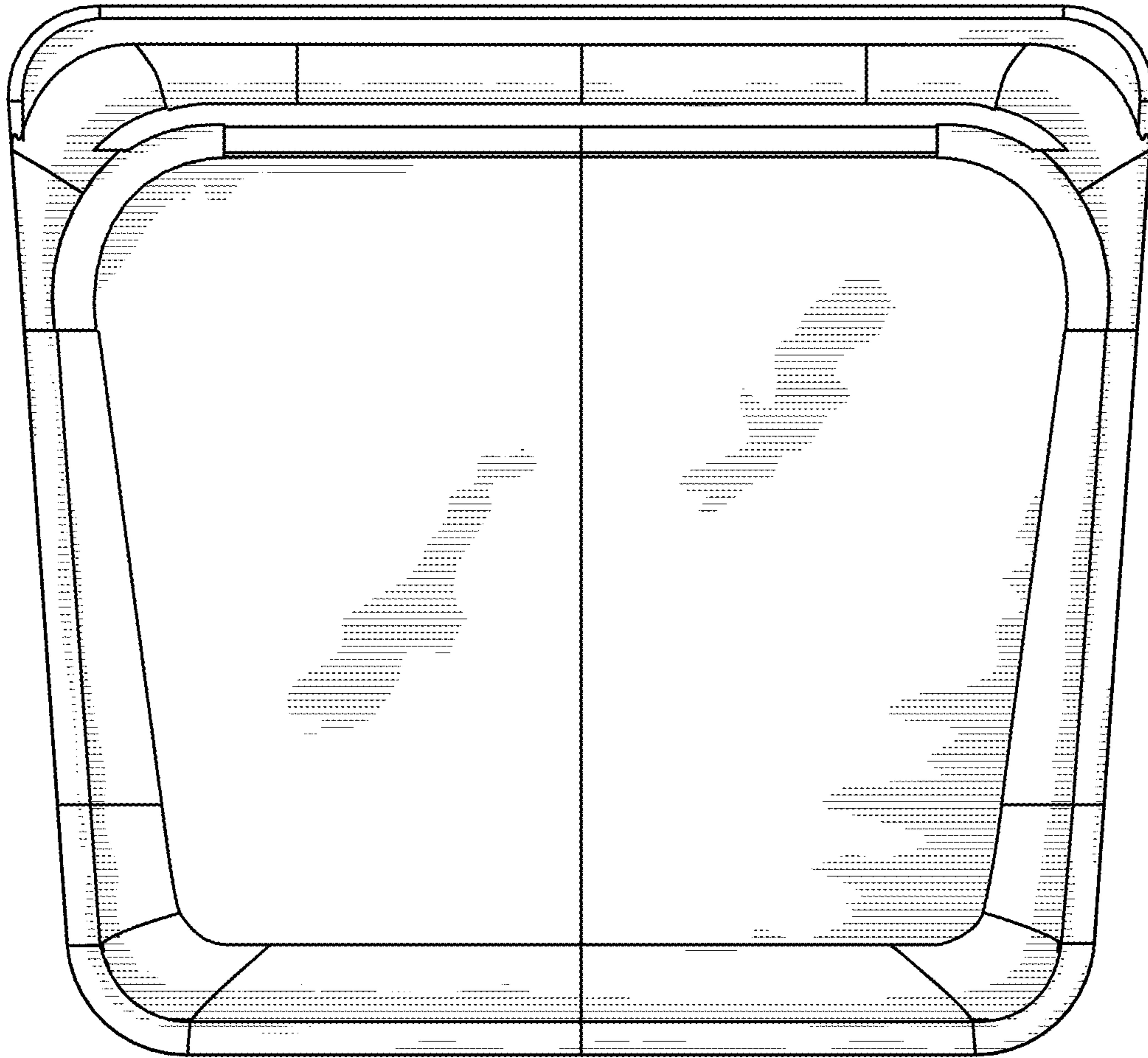

FIG. 4

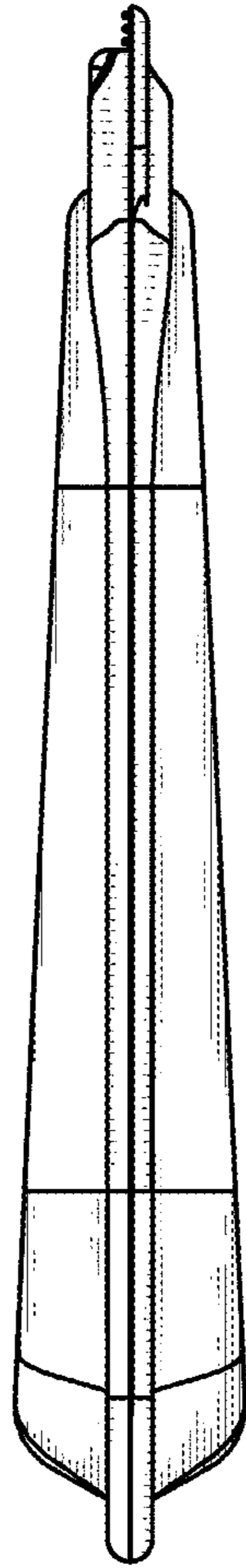

FIG. 5

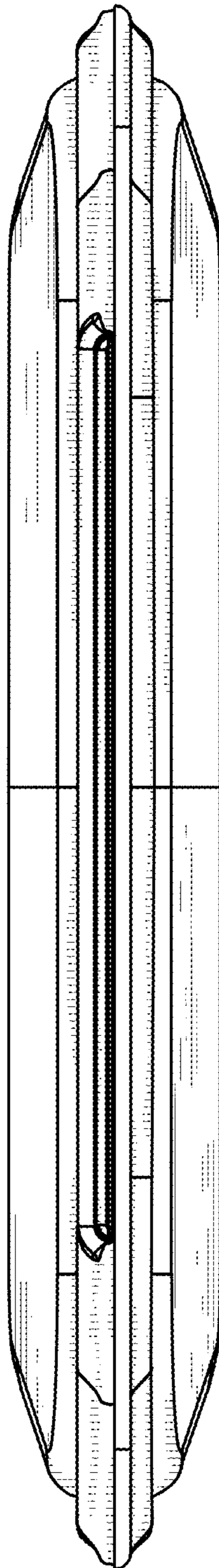

FIG. 6

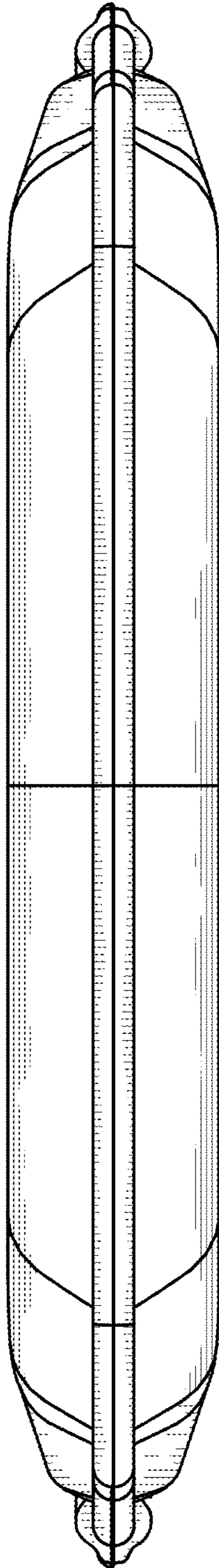

FIG. 7