



US00D770900S

(12) **United States Design Patent** (10) **Patent No.:** **US D770,900 S**  
**Hendricks et al.** (45) **Date of Patent:** **\*\* Nov. 8, 2016**

(54) **CONTAINER FOR A CONFECTIONERY**

(71) Applicant: **The Hershey Company**, Hershey, PA (US)

(72) Inventors: **William J. Hendricks**, Elizabethtown, PA (US); **Jonathon K. Markey**, Greensboro, NC (US)

(73) Assignee: **The Hershey Company**, Hershey, PA (US)

(\*\*) Term: **15 Years**

(21) Appl. No.: **29/532,191**

(22) Filed: **Jul. 2, 2015**

(51) **LOC (10) Cl.** ..... **09-01**

(52) **U.S. Cl.**  
USPC ..... **D9/516**

(58) **Field of Classification Search**  
USPC ..... D9/430, 414, 432, 524, 516  
CPC ..... B65D 1/00  
See application file for complete search history.

(56) **References Cited**

**U.S. PATENT DOCUMENTS**

D328,711 S	8/1992	Deflander	
D369,742 S *	5/1996	Brookshire	D9/523
D509,441 S *	9/2005	Wilson	D9/521
D609,098 S *	2/2010	Almstead, Jr.	D9/442
D723,372 S *	3/2015	Lecetre	D9/516
D743,266 S *	11/2015	Rathbone	D9/529
D754,913 S *	4/2016	Almsberger	D27/152
D758,882 S *	6/2016	Bruining	D9/524

\* cited by examiner

*Primary Examiner* — Cynthia Underwood

(74) *Attorney, Agent, or Firm* — Design IP

(57) **CLAIM**

The ornamental design for a container for a confectionery, as shown and described.

**DESCRIPTION**

FIG. 1 is a rear left perspective view of a first embodiment of a container for a confectionery showing our new design; FIG. 2 is a front elevation view thereof; FIG. 3 is a rear elevation view thereof; FIG. 4 is a left side elevation view thereof; FIG. 5 is a right side elevation view thereof; FIG. 6 is a top plan view thereof; FIG. 7 is a bottom plan view thereof; FIG. 8 is a front right perspective view of the container for a confectionery of FIG. 1, showing a portion of the lid portion thereof in an alternate position; FIG. 9 is a rear left perspective view of a second embodiment of a container for a confectionery showing our new design; FIG. 10 is a front elevation view thereof; FIG. 11 is a rear elevation view thereof; FIG. 12 is a left side elevation view thereof; FIG. 13 is a right side elevation view thereof; FIG. 14 is a top plan view thereof; FIG. 15 is a bottom plan view thereof; and, FIG. 16 is a front right perspective view of the container for a confectionery of FIG. 9, showing a portion of the lid portion thereof in an alternate position.

The broken lines appearing in FIGS. 1-16 represent environmental subject matter only and form no part of the claimed design. In the embodiment of FIGS. 9-16, the oblique shade lines shown on the container for a confectionery represent a translucent material.

**1 Claim, 10 Drawing Sheets**

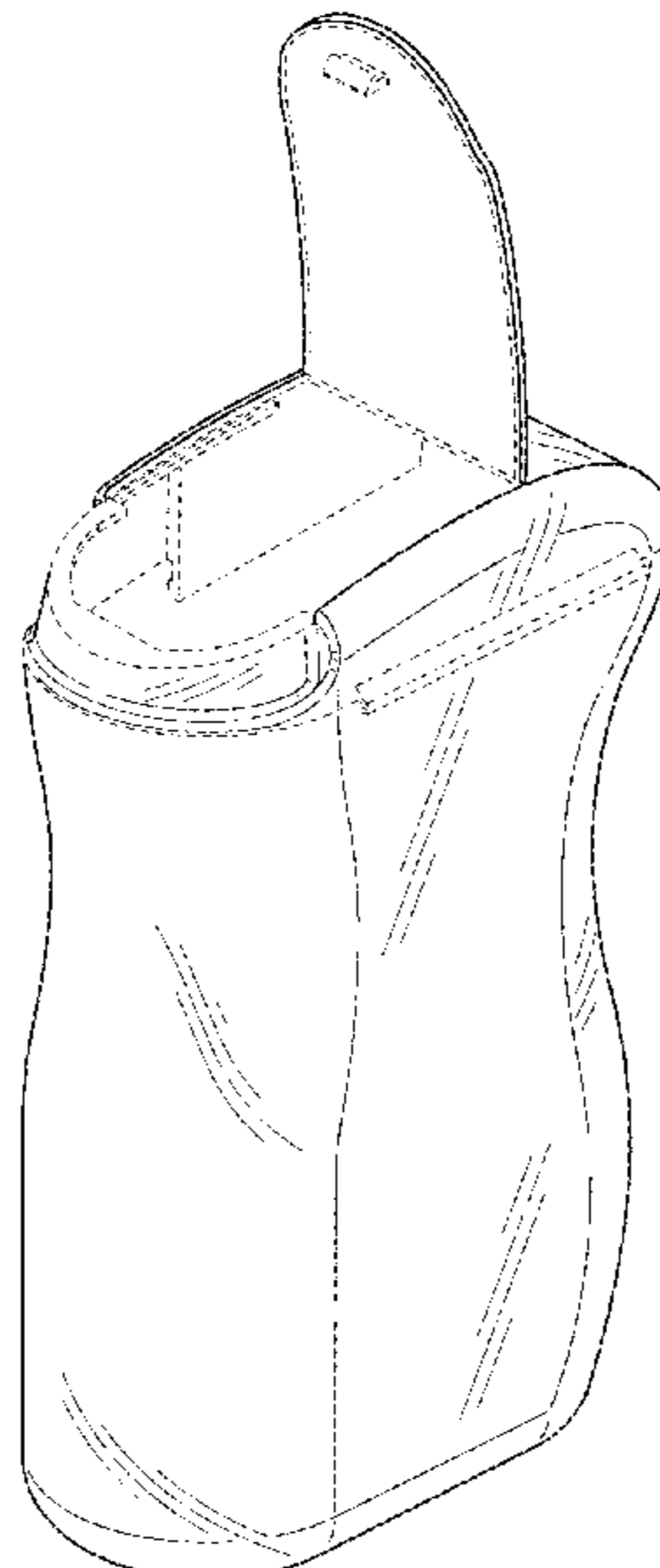

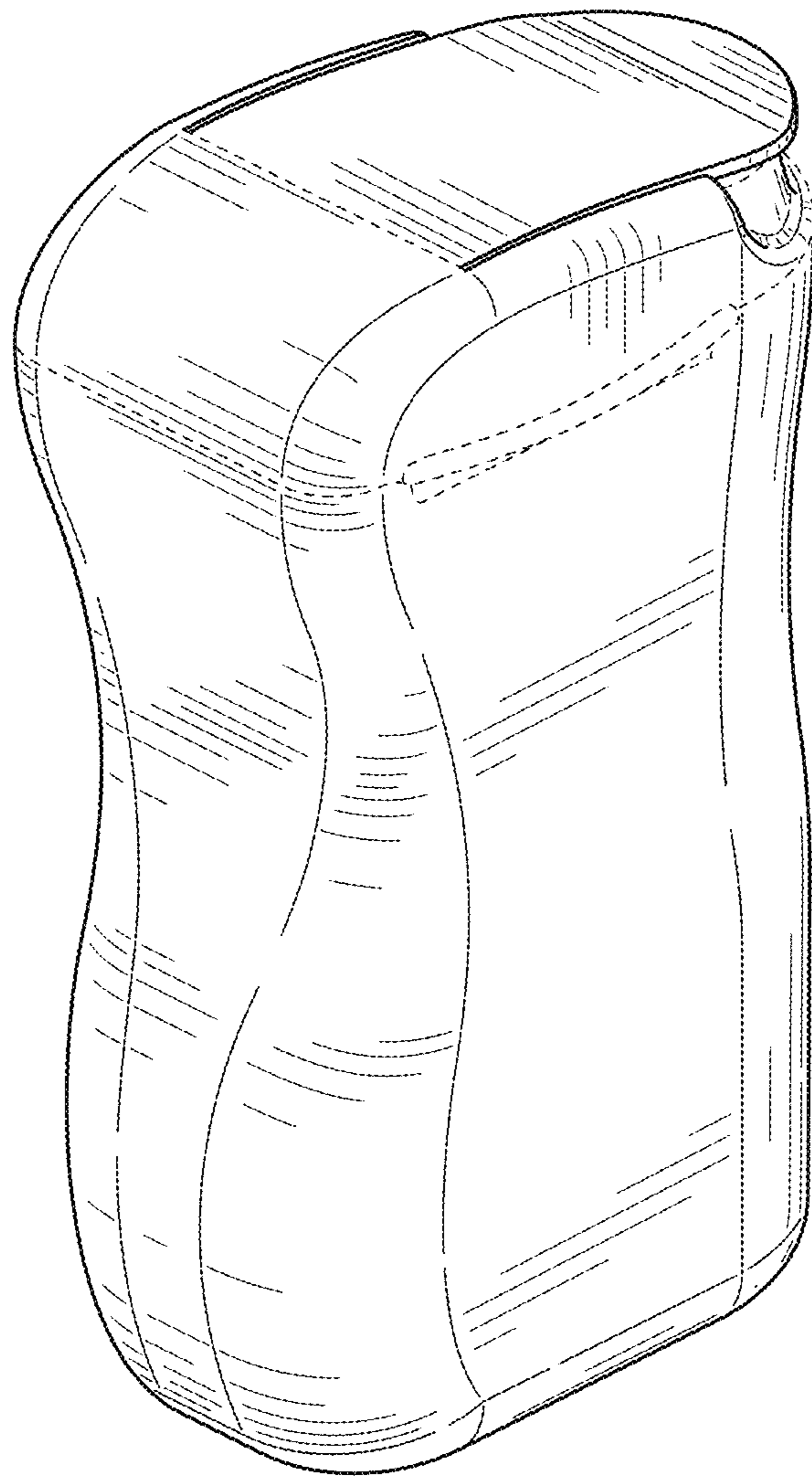

FIG. 1

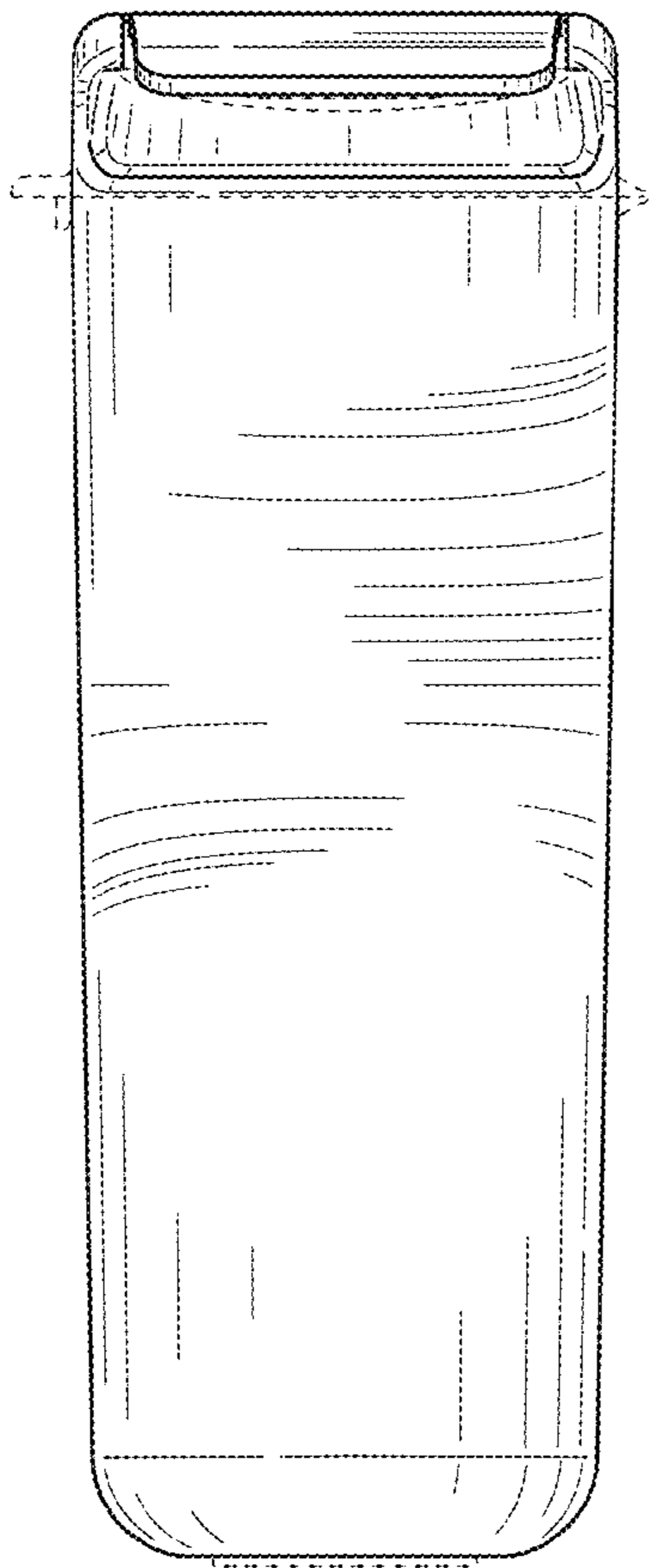

FIG. 2

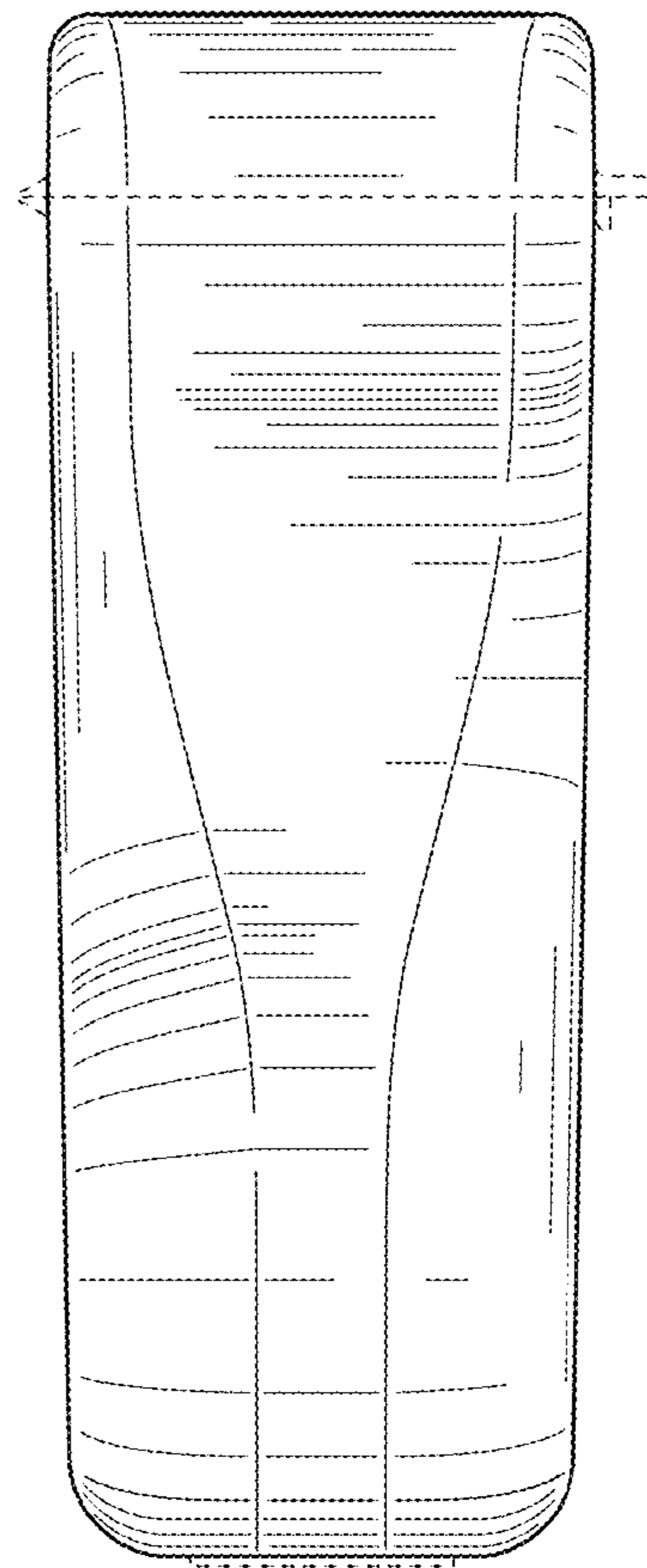

FIG. 3

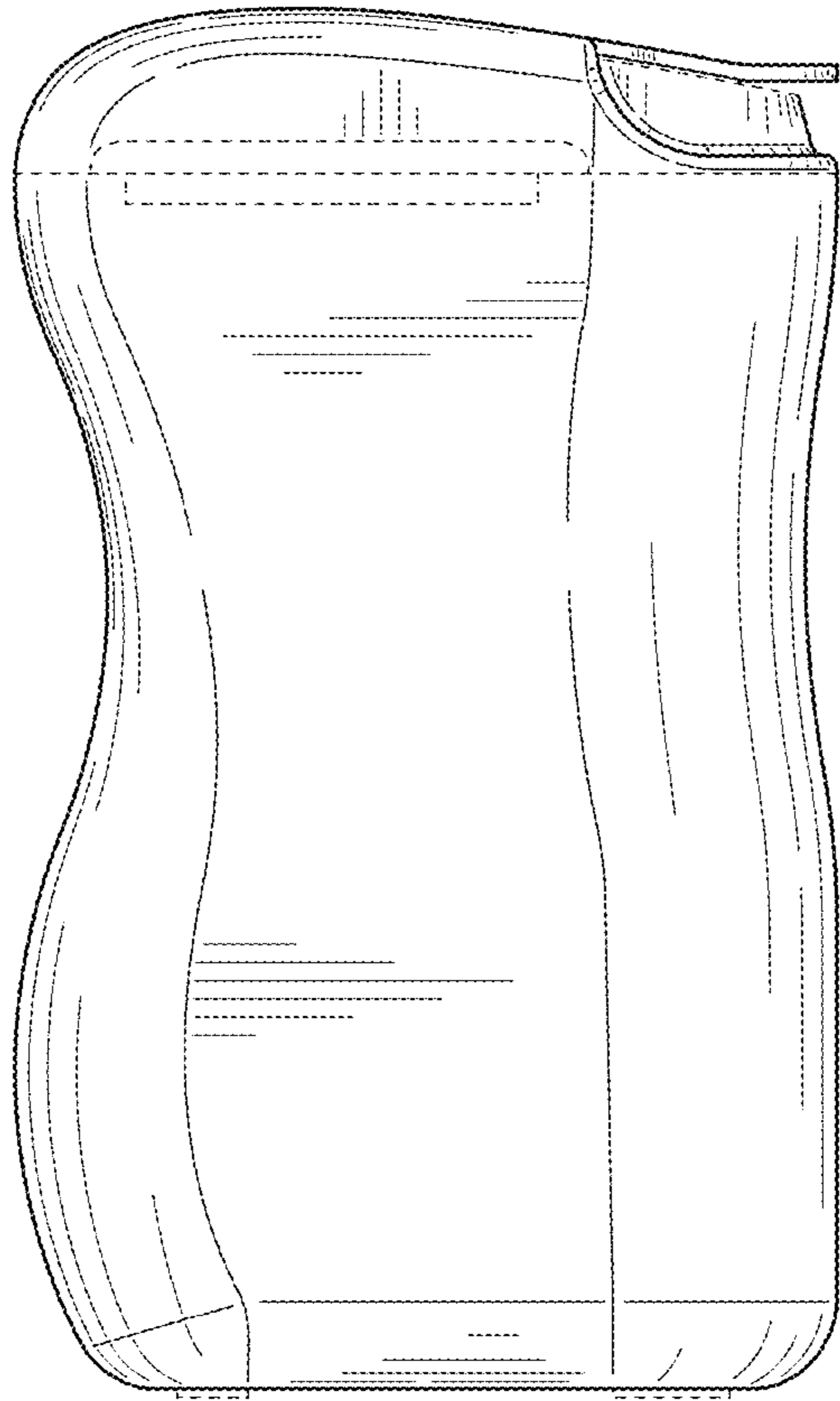

FIG. 4

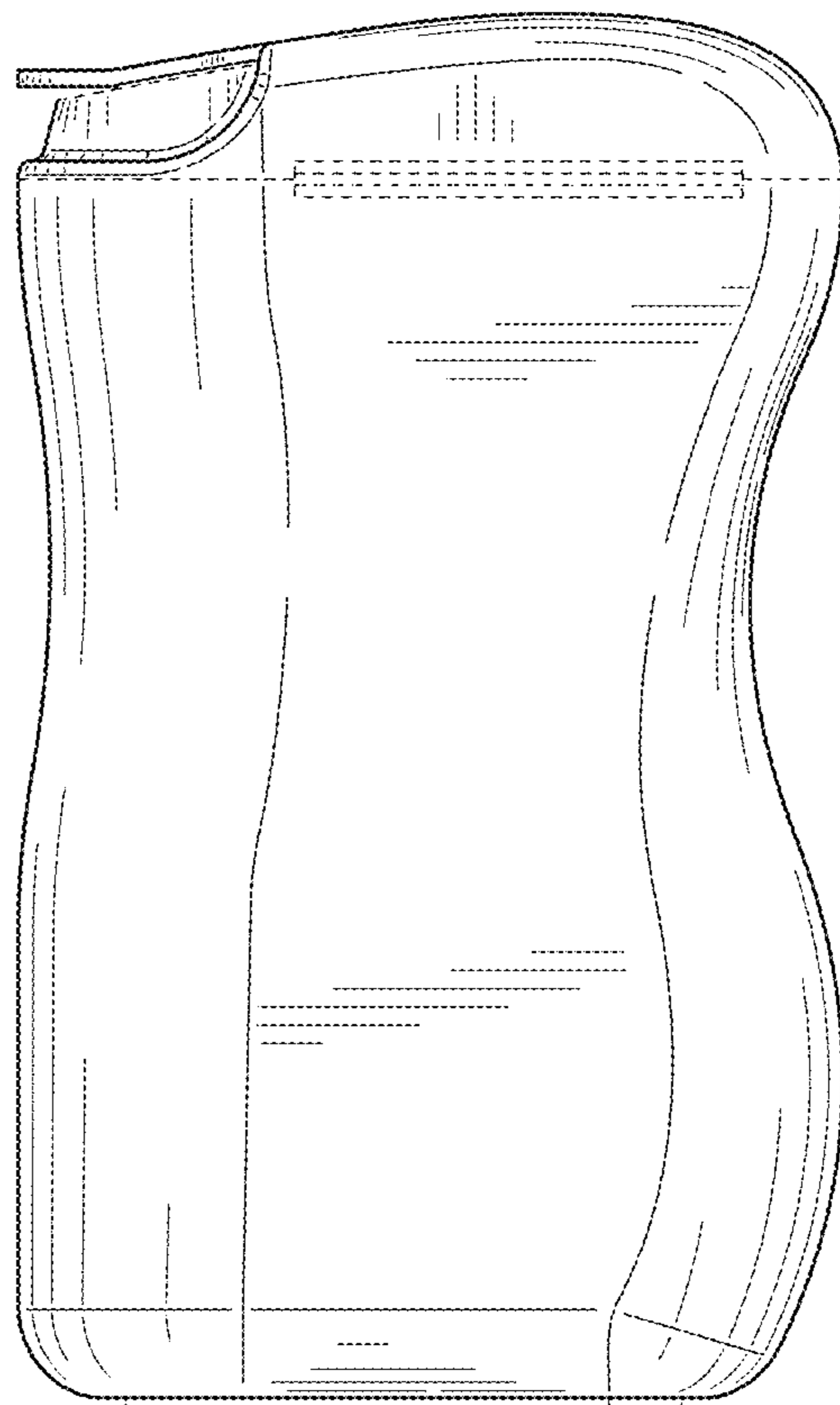

FIG. 5

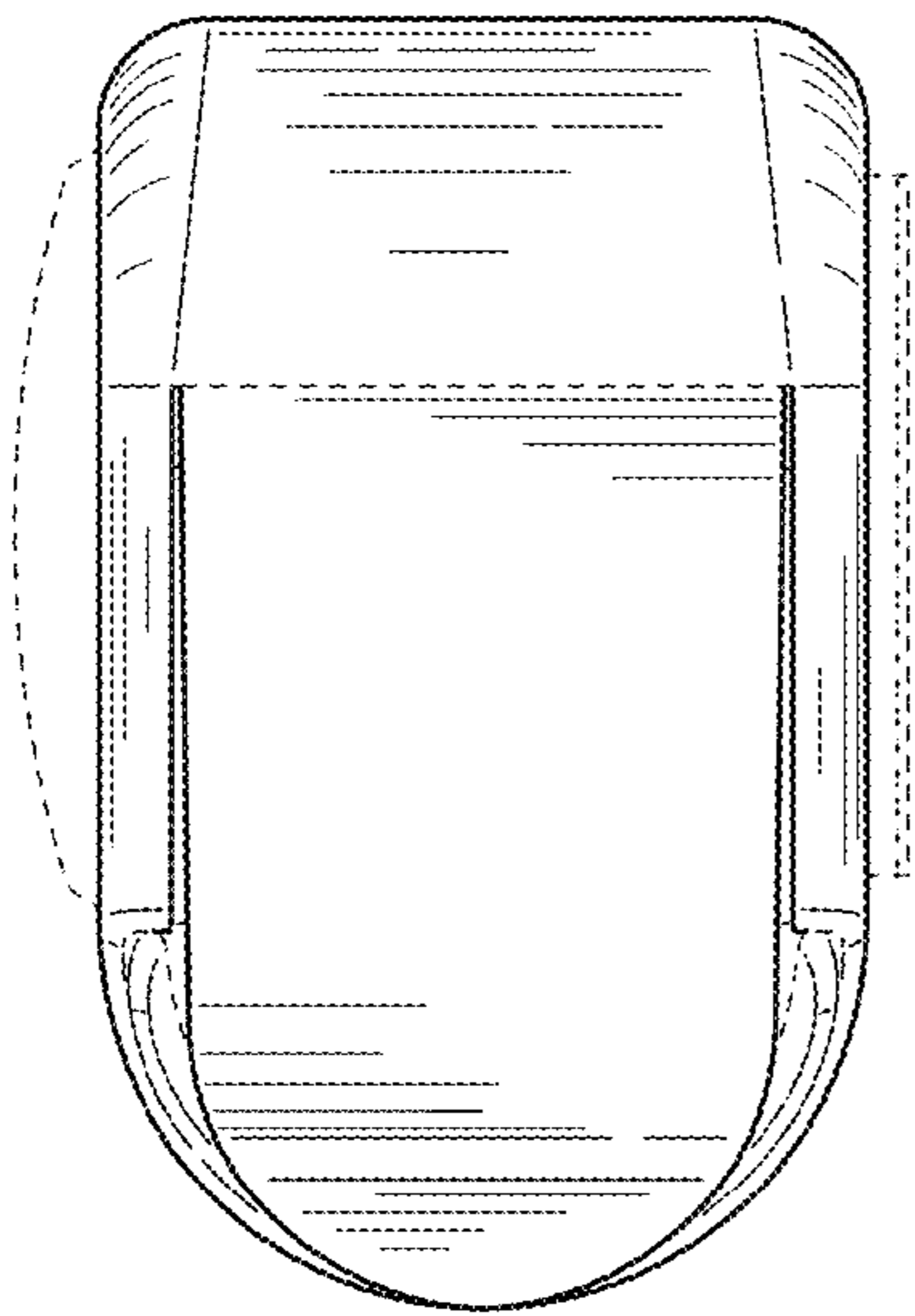

FIG. 6

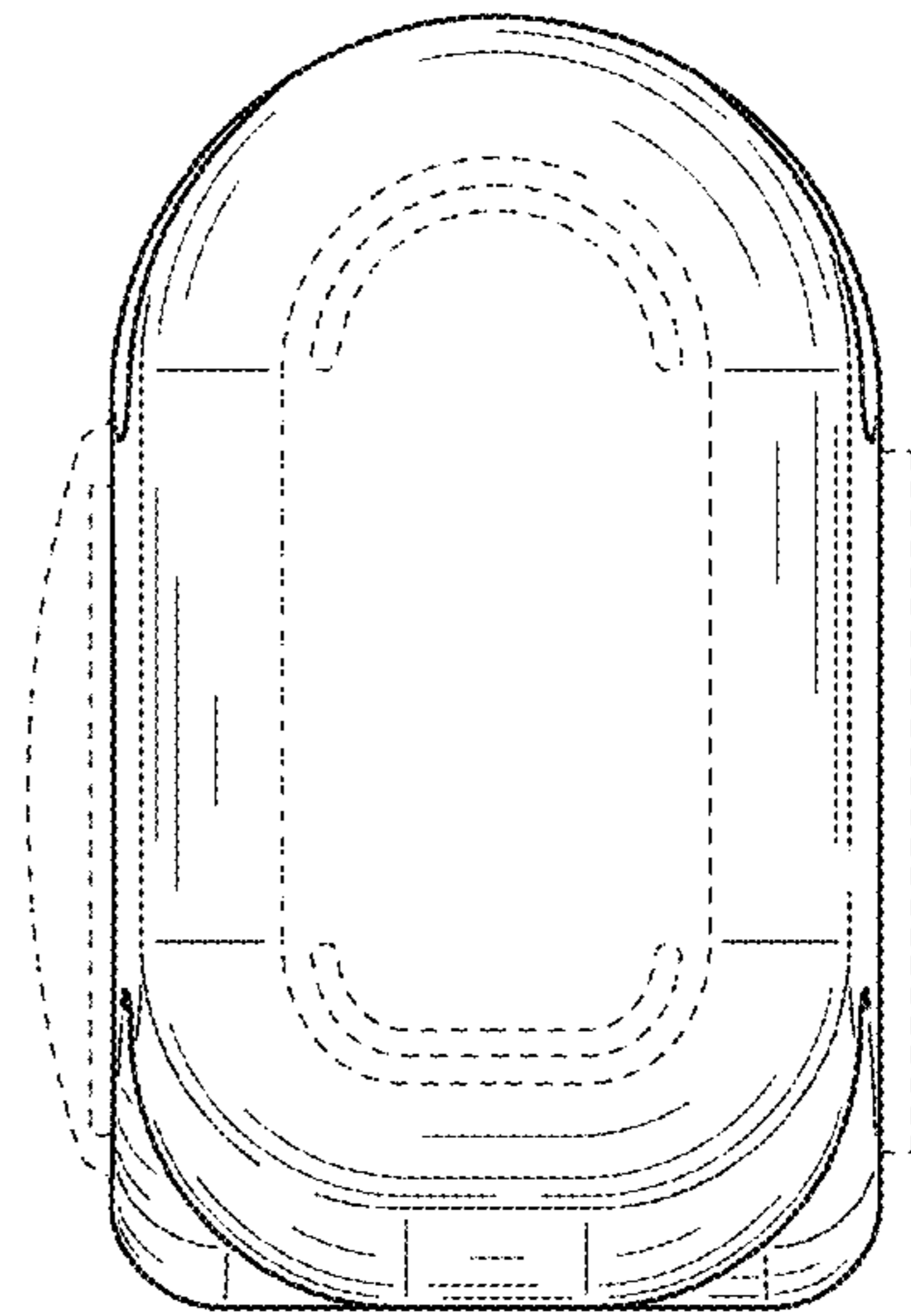

FIG. 7

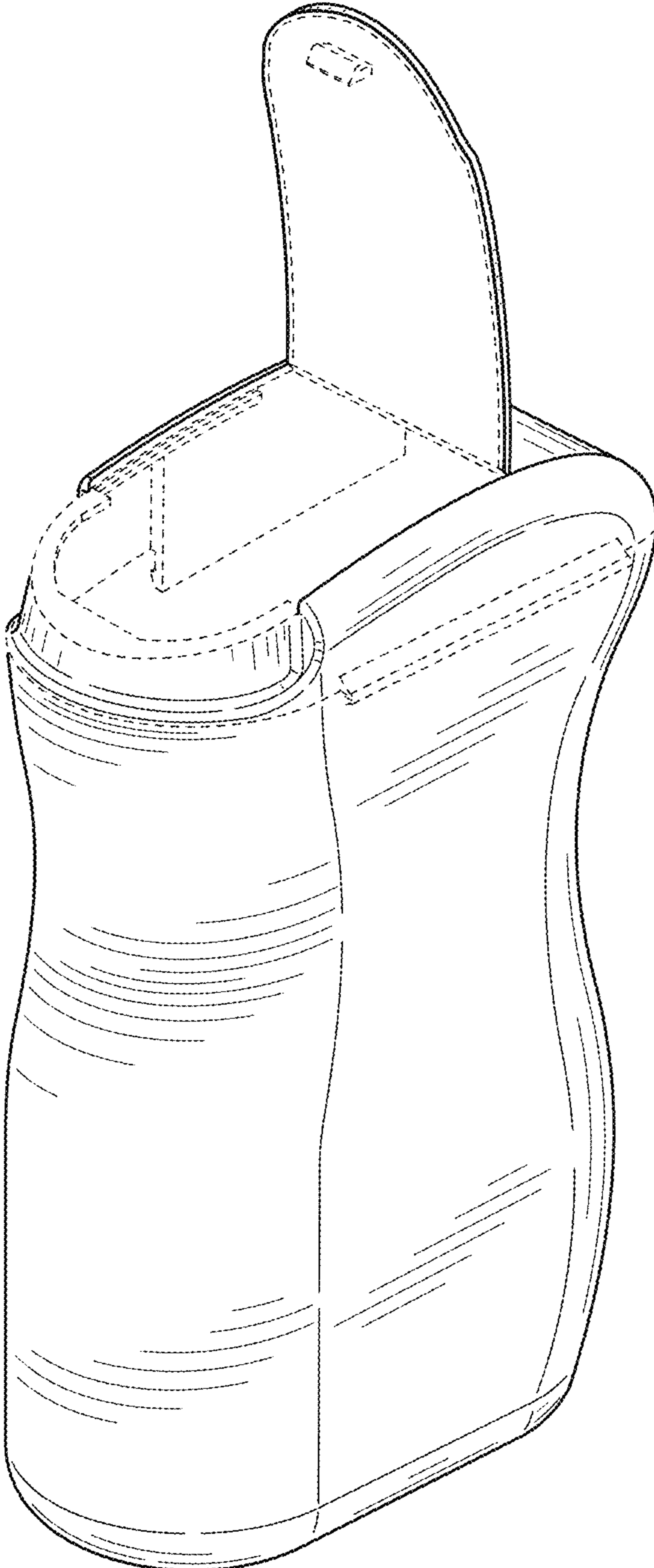

FIG. 8

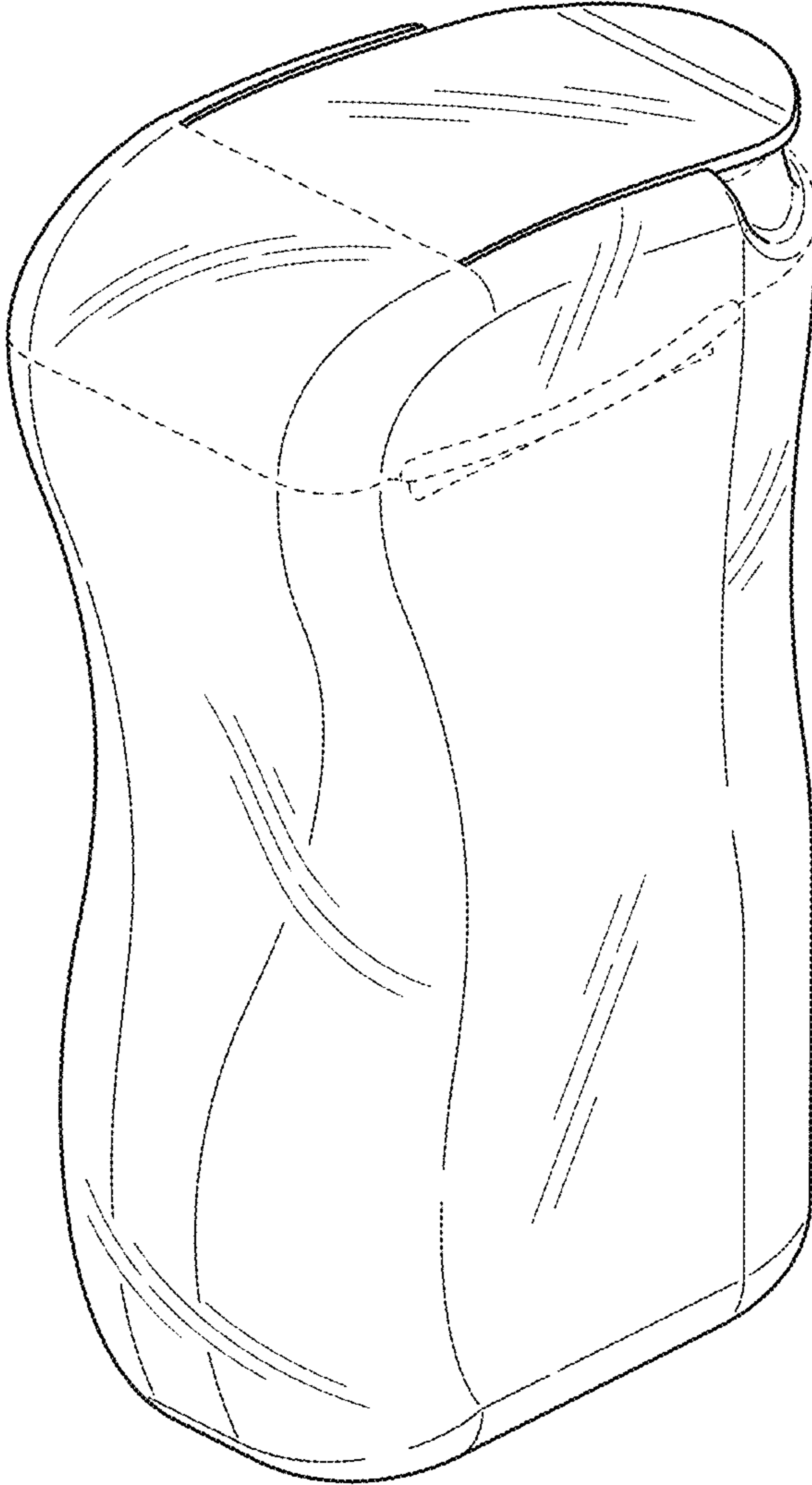

FIG. 9

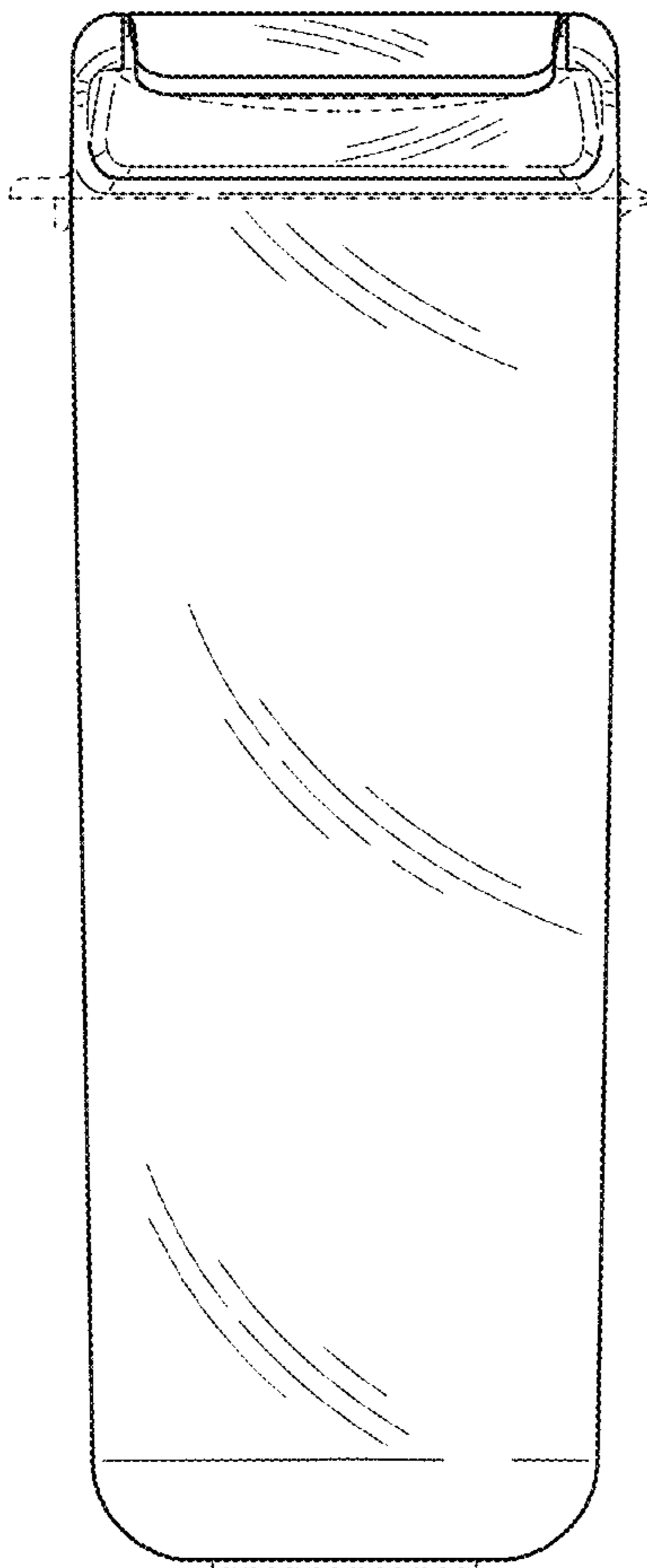

FIG. 10

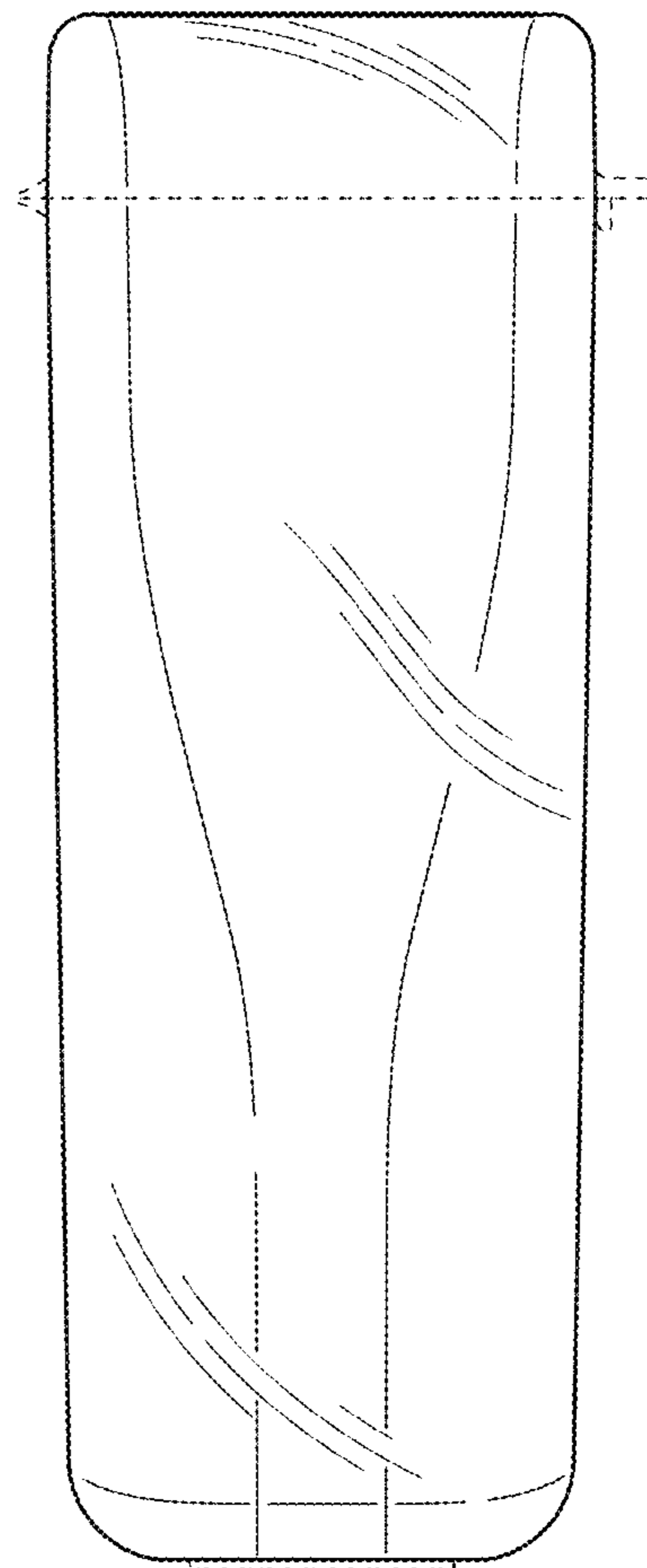

FIG. 11



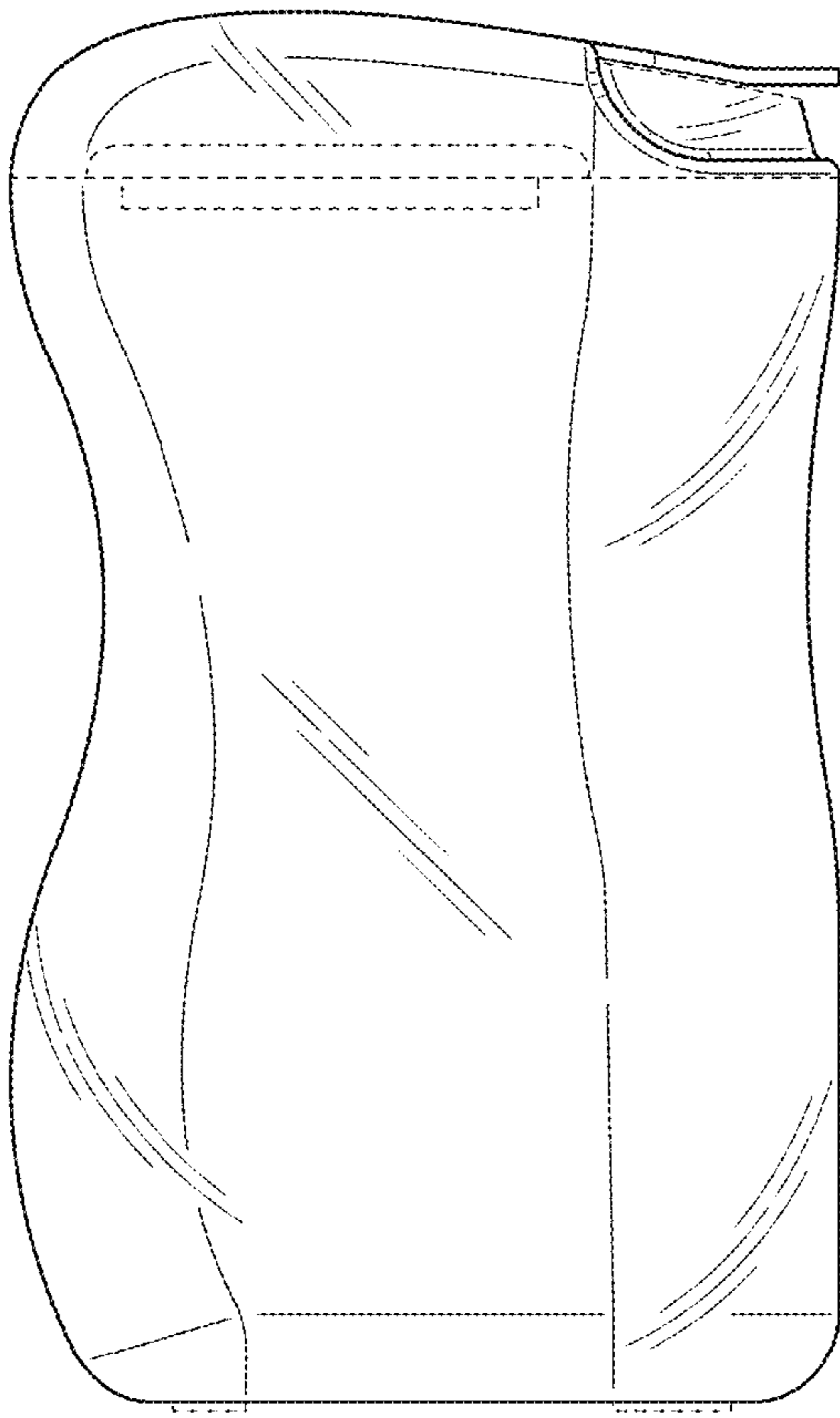

FIG. 12

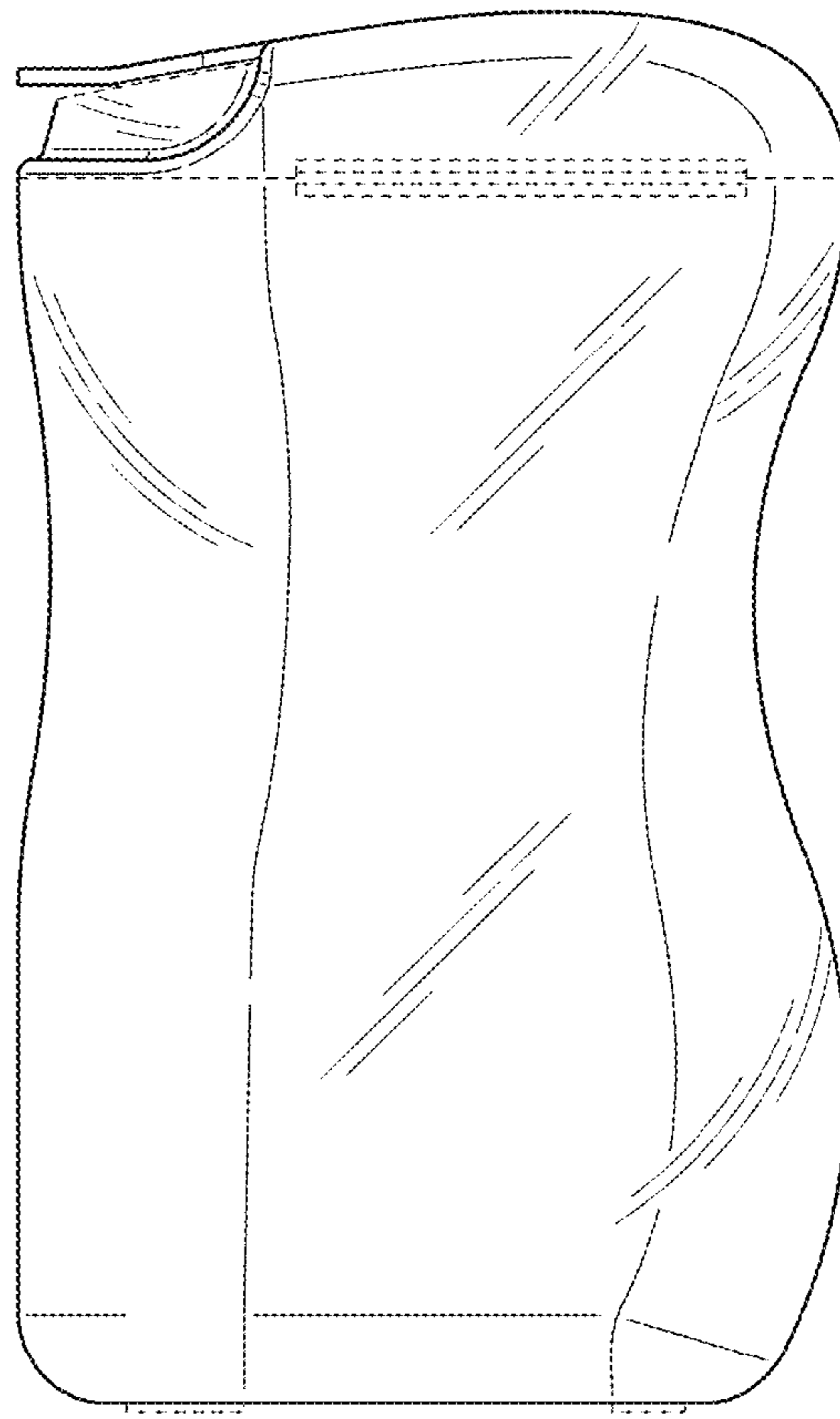

FIG. 13

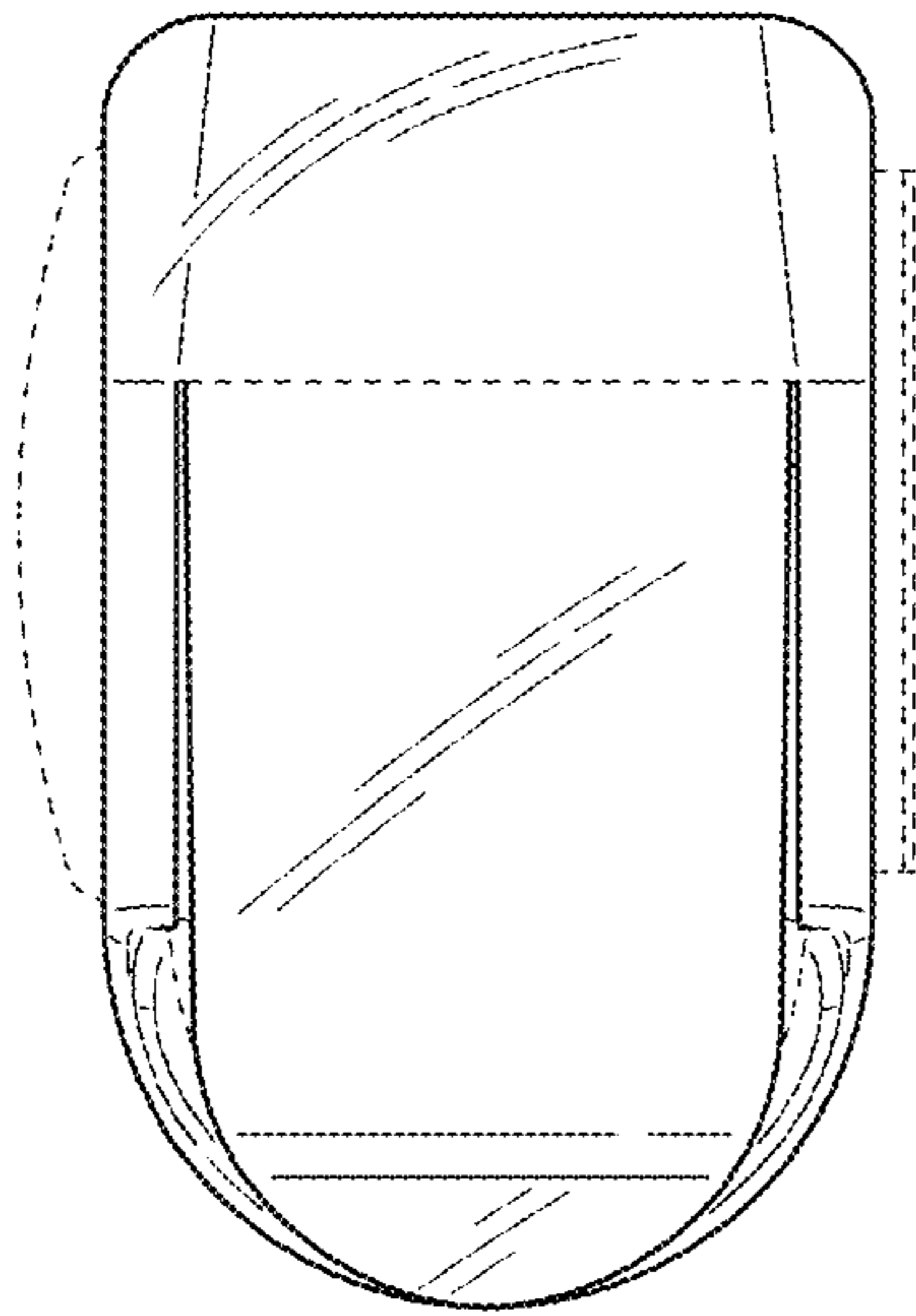

FIG. 14

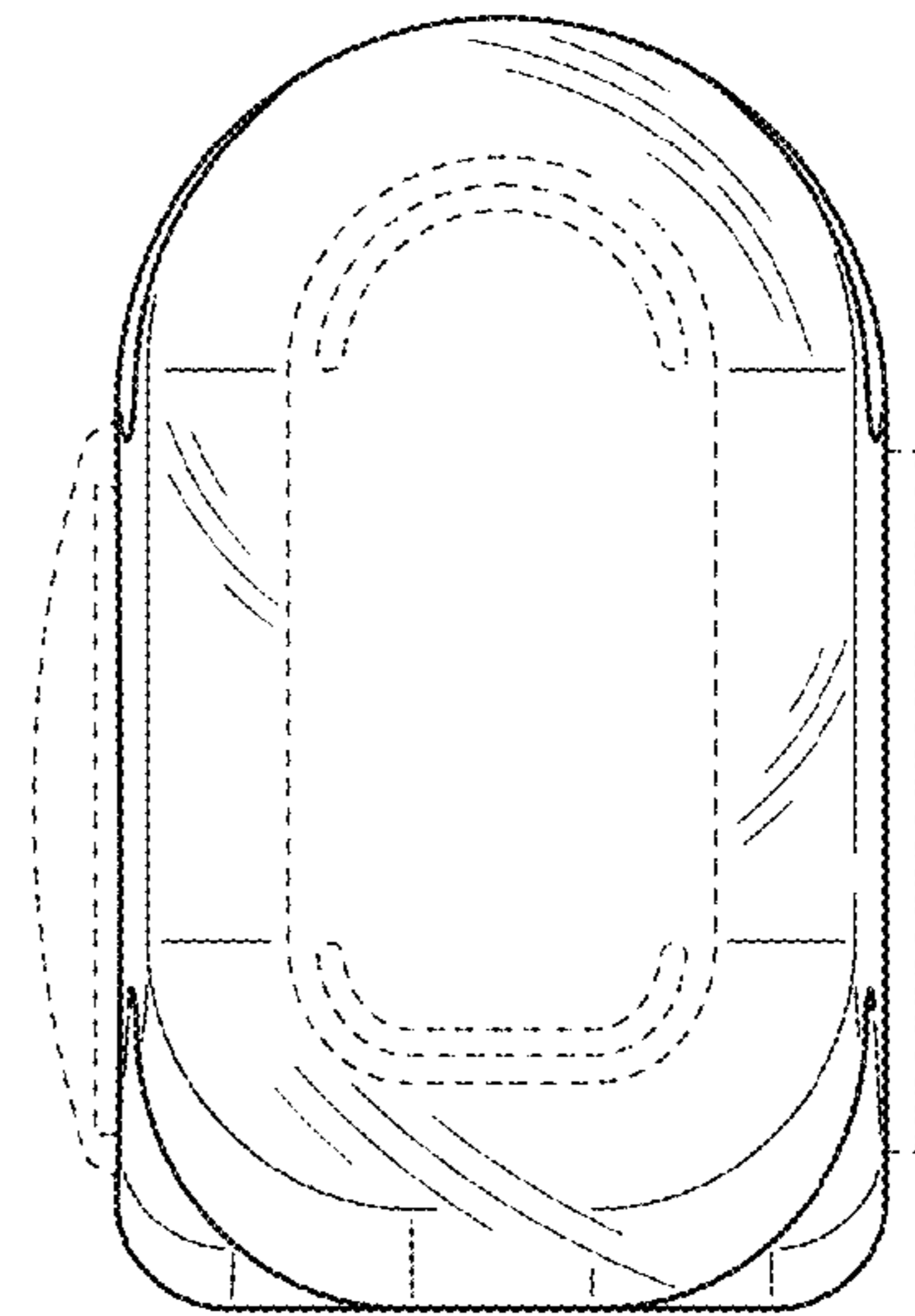

FIG. 15

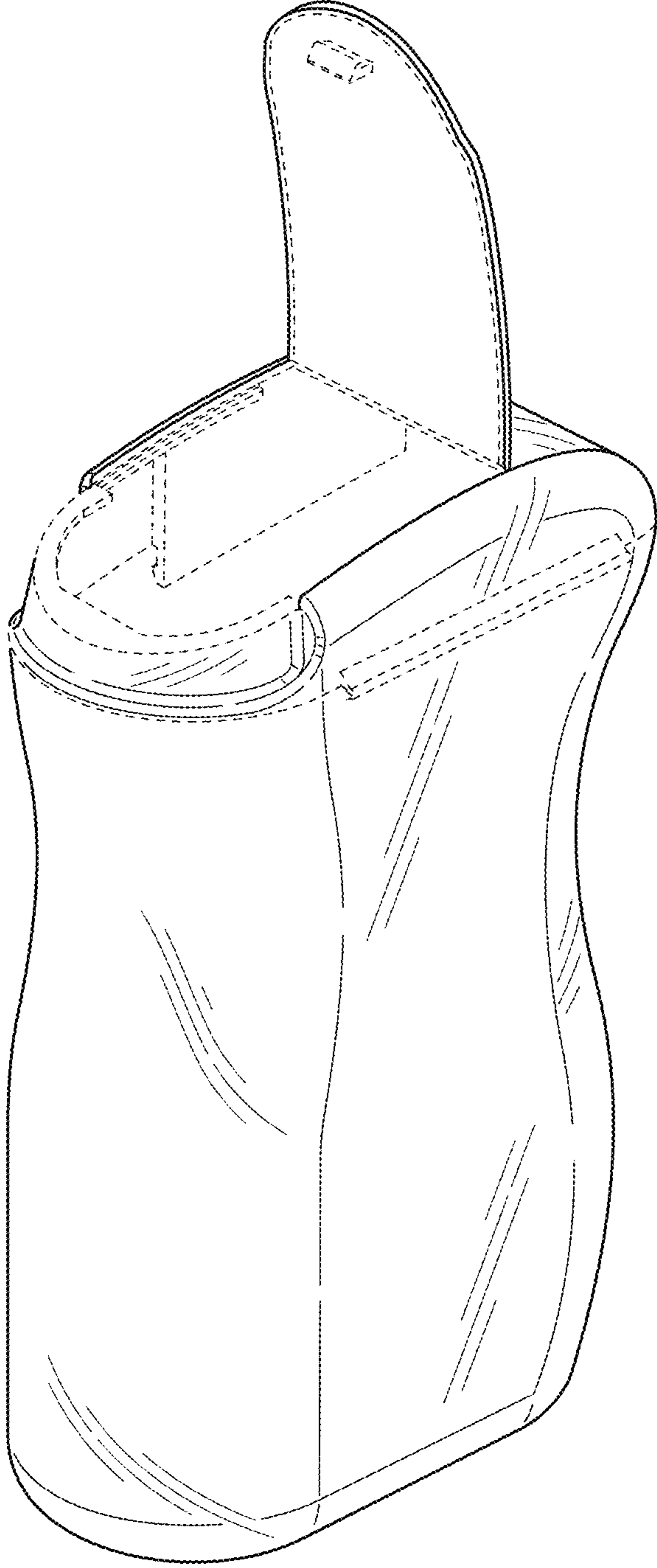

FIG. 16