



US00D770884S

(12) **United States Design Patent** (10) **Patent No.:** **US D770,884 S**
Moreau et al. (45) **Date of Patent:** **** Nov. 8, 2016**

(54) **FASTENER WITH LOCKING RING**
(71) Applicant: **Ty-Flot, Inc.**, Manchester, NH (US)
(72) Inventors: **Darrell A. Moreau**, Manchester, NH (US); **Andre W. Moreau**, Bedford, NH (US)
(73) Assignee: **Ty-Flot, Inc.**, Manchester, NH (US)
(**) Term: **14 Years**
(21) Appl. No.: **29/514,784**
(22) Filed: **Jan. 16, 2015**
(51) **LOC (10) Cl.** **08-08**
(52) **U.S. Cl.**
USPC **D8/382**
(58) **Field of Classification Search**
USPC D8/331, 333, 340, 343, 349, 382, 387,
D8/388, 391, 393, 397, 399
CPC F16G 15/00; F16G 15/02; F16G 15/04;
F16G 15/06; Y10T 403/32861; F16C 11/04
See application file for complete search history.

(56) **References Cited**
U.S. PATENT DOCUMENTS
D32,793 S * 6/1900 Fauber 411/427
1,269,733 A * 6/1918 Nelson F16G 15/02
59/85
2,798,404 A * 7/1957 Schaefer F16B 37/16
16/110.1
4,337,614 A * 7/1982 Briscoe F16G 15/06
411/518
4,398,322 A * 8/1983 Ewen F16B 21/04
24/595.1
D336,844 S * 6/1993 Hozapfel D8/387
5,312,199 A * 5/1994 Smith, Jr. F16C 11/00
403/119
5,433,547 A * 7/1995 Hart F16B 39/32
403/154
5,628,178 A * 5/1997 Beckham F16G 13/02
59/86
D454,773 S * 3/2002 Gilbert D8/331
D455,636 S * 4/2002 Gilbert D8/331

(Continued)

Primary Examiner — Sandra Snapp
Assistant Examiner — Ieisha Price
(74) *Attorney, Agent, or Firm* — Mesmer & Deleault, PLLC

(57) **CLAIM**
We claim the ornamental design for a fastener with locking ring, as shown and described.

DESCRIPTION

FIG. 1 is a left side perspective view of a fastener with locking ring showing our new design with the locking ring installed on the fastener head portion;
FIG. 2 is a right side perspective view thereof;
FIG. 3 is a front elevational view thereof;
FIG. 4 is a rear elevational view thereof;
FIG. 5 is a left side elevational view thereof shown rotated ninety degrees to an upright position;
FIG. 6 is a left side perspective view thereof, shown without the locking ring;
FIG. 7 is a right side perspective view thereof, shown without the locking ring;
FIG. 8 is a front elevational view thereof, shown without the locking ring;
FIG. 9 is a rear elevational view thereof, shown without the locking ring;
FIG. 10 is a left side elevational view thereof, shown rotated ninety degrees to an upright position;
FIG. 11 is a left side elevational view of the locking ring shown at an enlarged scale;
FIG. 12 is a front elevational view of the locking ring shown at the enlarged scale;
FIG. 13 is a left side perspective view of the locking ring shown at the enlarged scale;
FIG. 14 is a right side perspective view of the locking ring shown at the enlarged scale; and,
FIG. 15 is an environmental left side perspective view of the Fastener with locking ring.
The broken lines in the drawings illustrate portions of the fastener with locking ring and form no part of the claimed design. The broken line showing of the shackle body in FIG. 15 illustrates the environment of the claimed design and forms no part thereof.

1 Claim, 6 Drawing Sheets

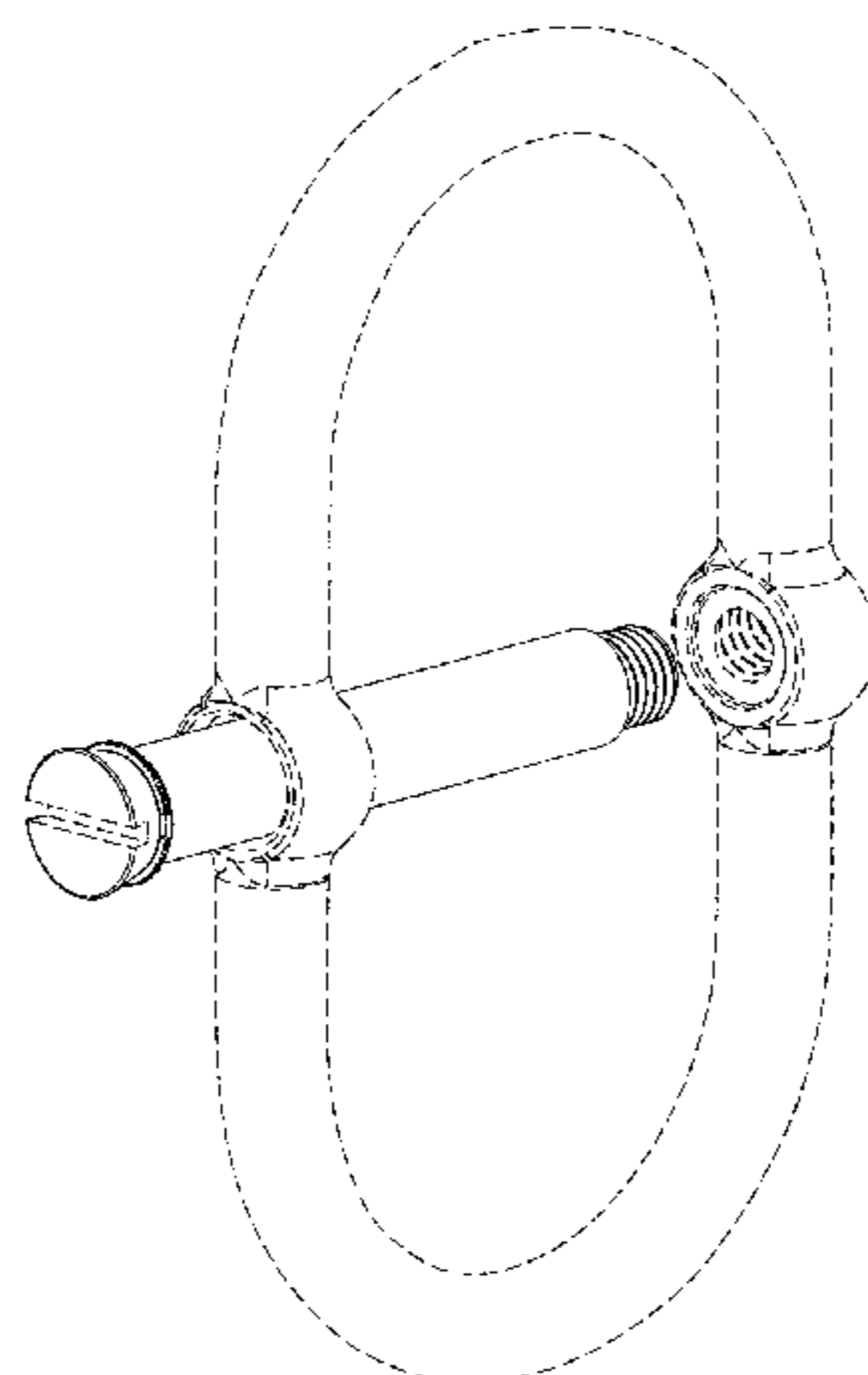

(56)

References Cited

U.S. PATENT DOCUMENTS

D455,945 S *	4/2002	Gilbert	D8/331	2012/0073088 A1*	3/2012	Boeckman	F16G 15/06
6,948,752 B1 *	9/2005	Crow	B66C 1/125	2013/0067881 A1*	3/2013	Khrakovsky	F16G 15/06
				294/82.11					59/86
D568,729 S *	5/2008	Gary	D8/382	2014/0212206 A1*	7/2014	Moreau	F16G 15/06
D698,621 S *	2/2014	Moreau	D8/333	2015/0121836 A1*	5/2015	Moreau	F16G 15/08
D708,042 S *	7/2014	Moreau	D8/331					403/150
D730,717 S *	6/2015	Moreau	D8/331	2015/0143674 A1*	5/2015	Maurice	F16B 45/04
9,169,900 B1 *	10/2015	Moreau	F16G 15/06					24/598.7
2011/0265442 A1*	11/2011	Segura	B66C 1/10	2016/0076572 A1*	3/2016	O'Dell	F16B 19/002
				59/86					411/508

* cited by examiner

FIG. 1

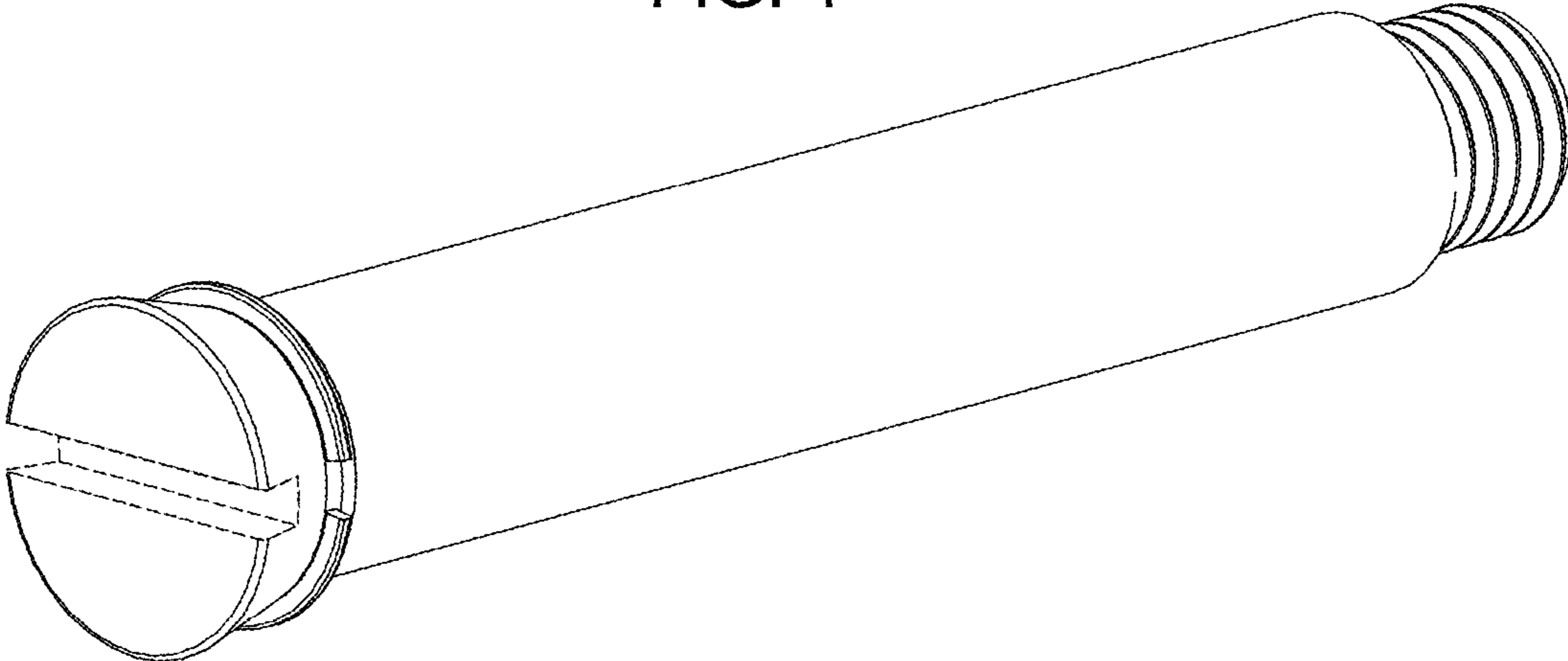

FIG. 2

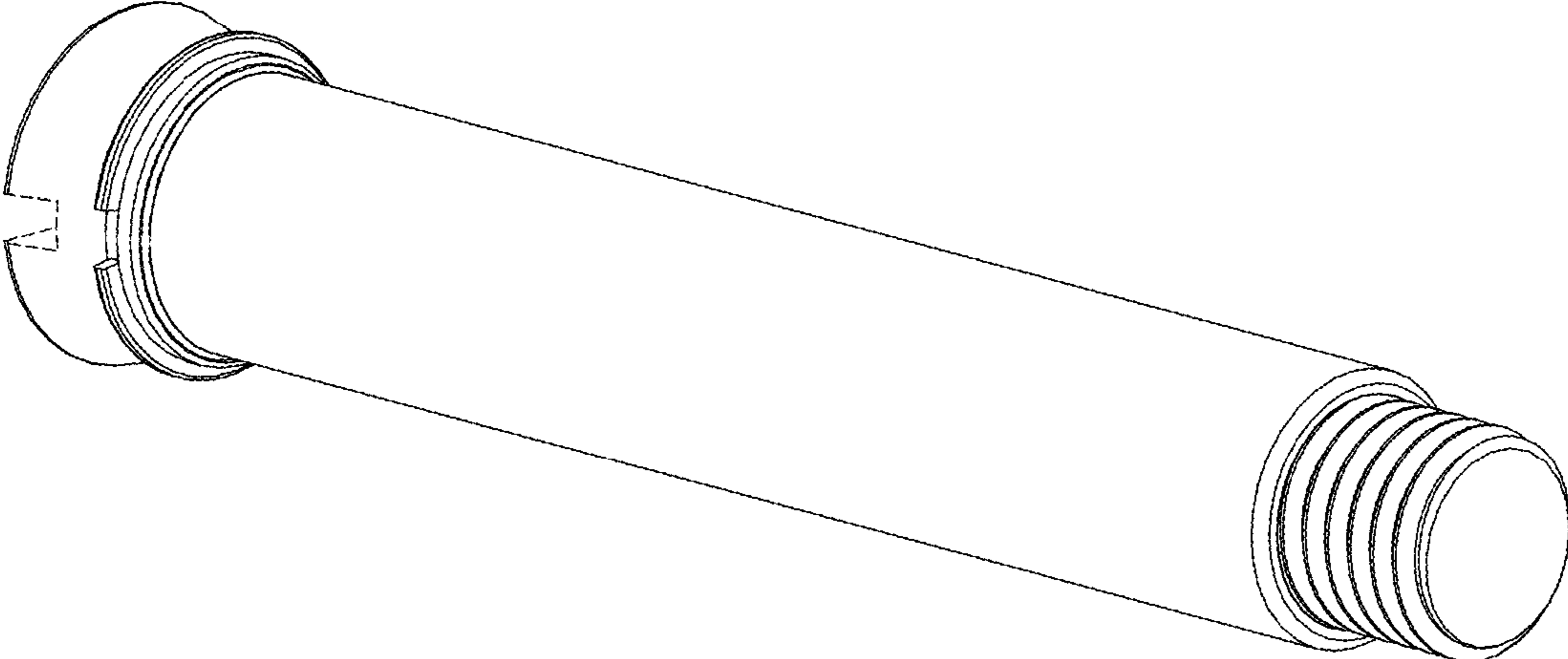

FIG. 3

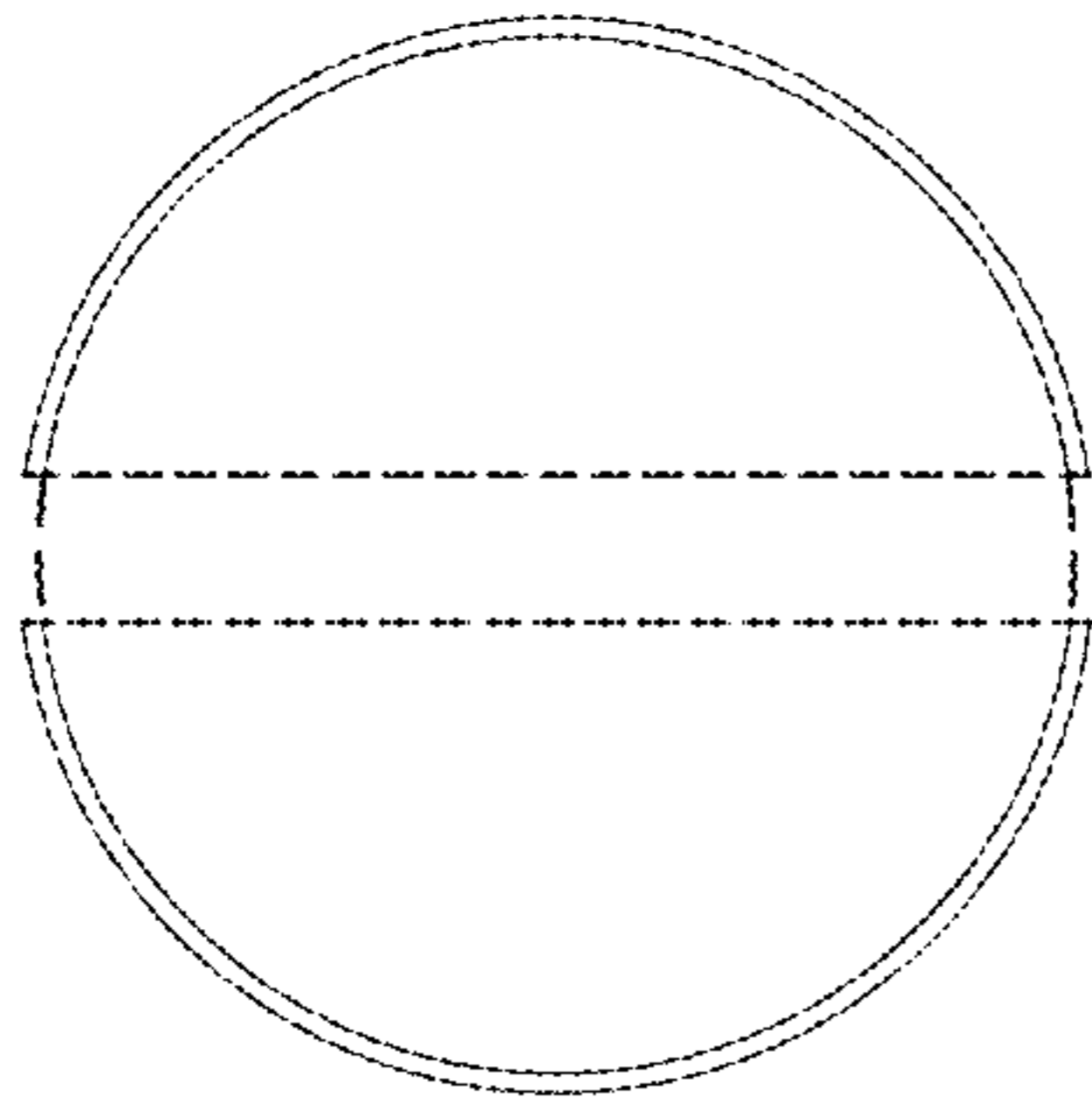

FIG. 4

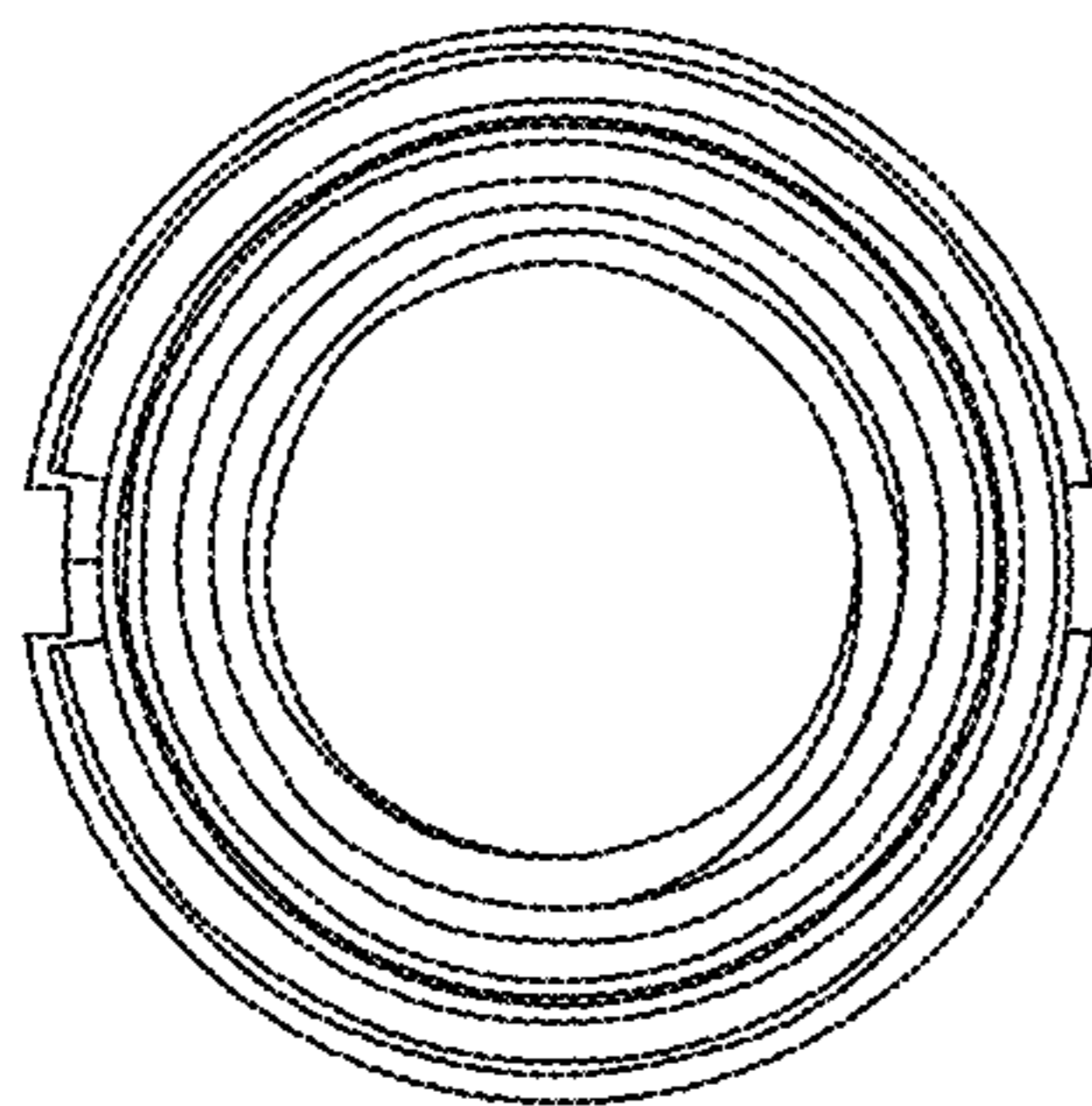

FIG. 5

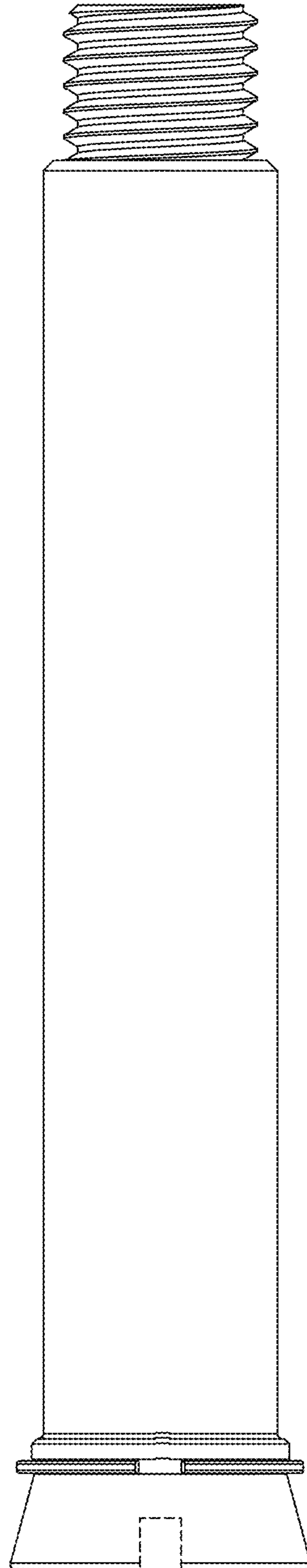

FIG. 6

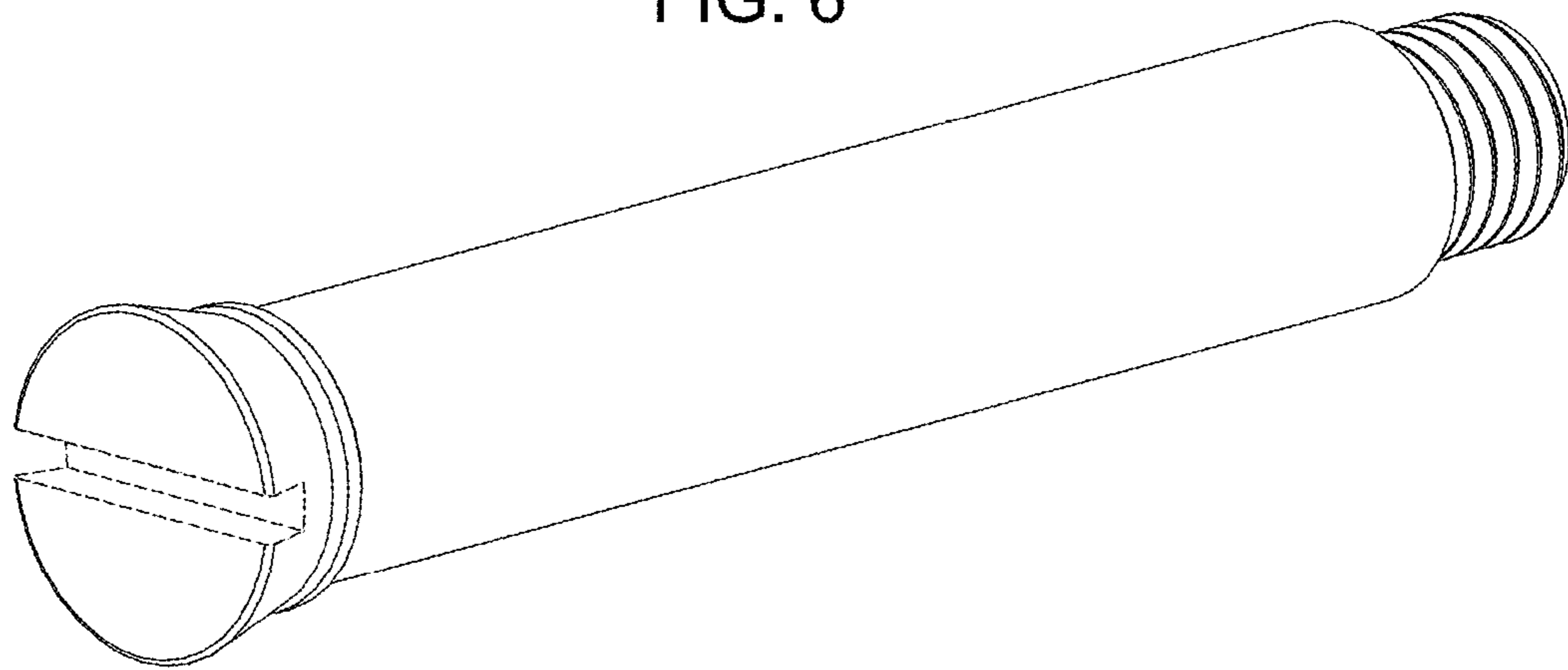

FIG. 7

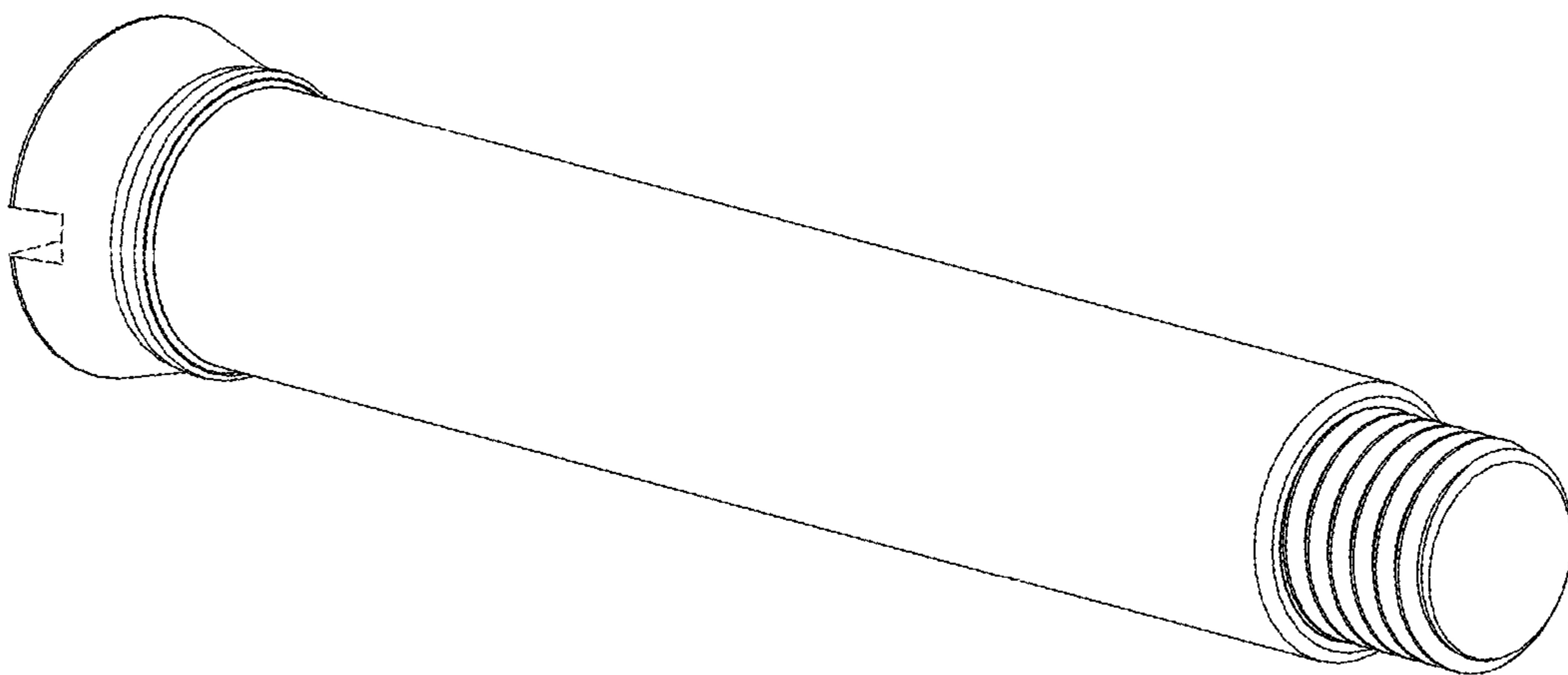

FIG. 8

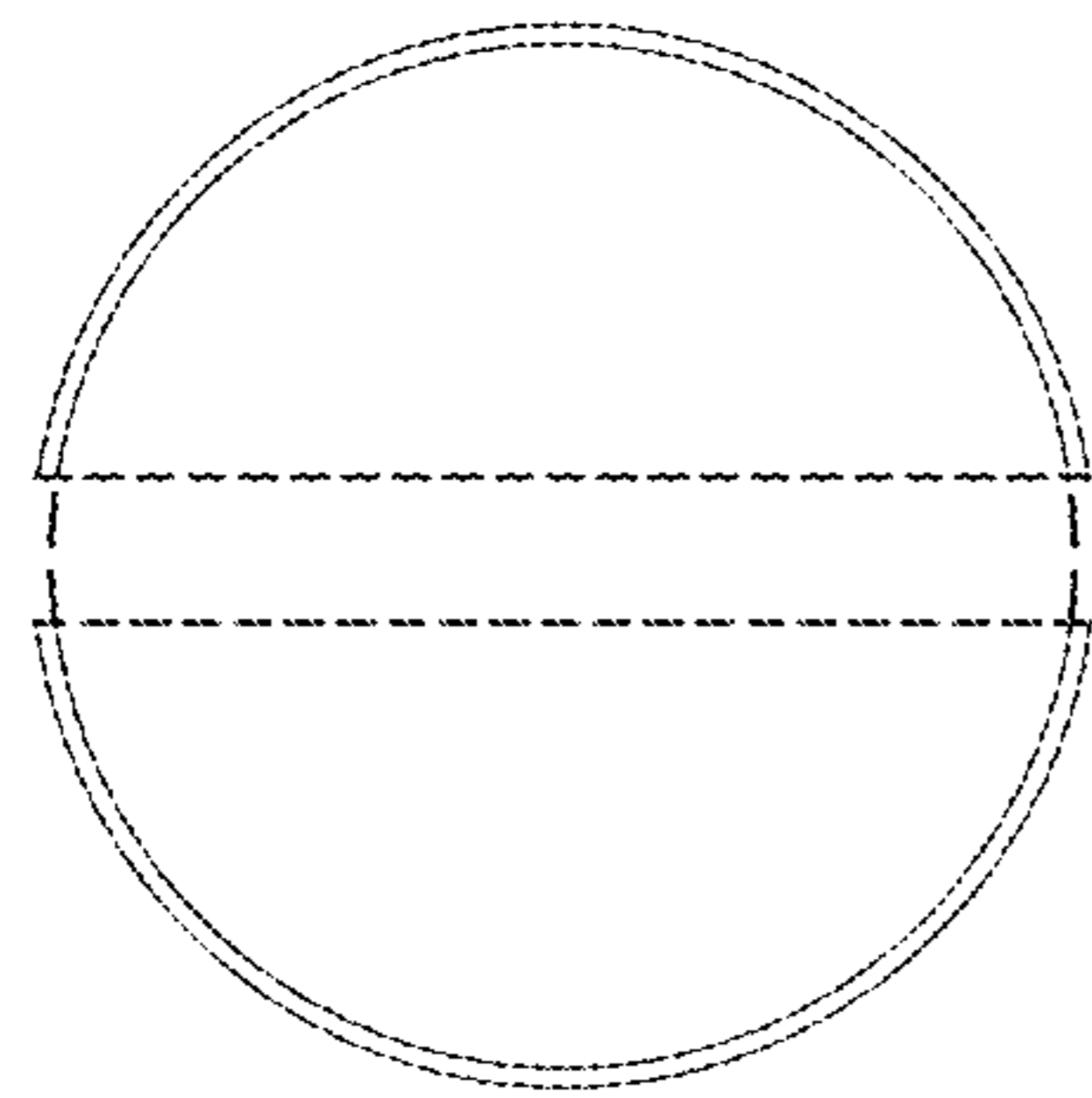

FIG. 9

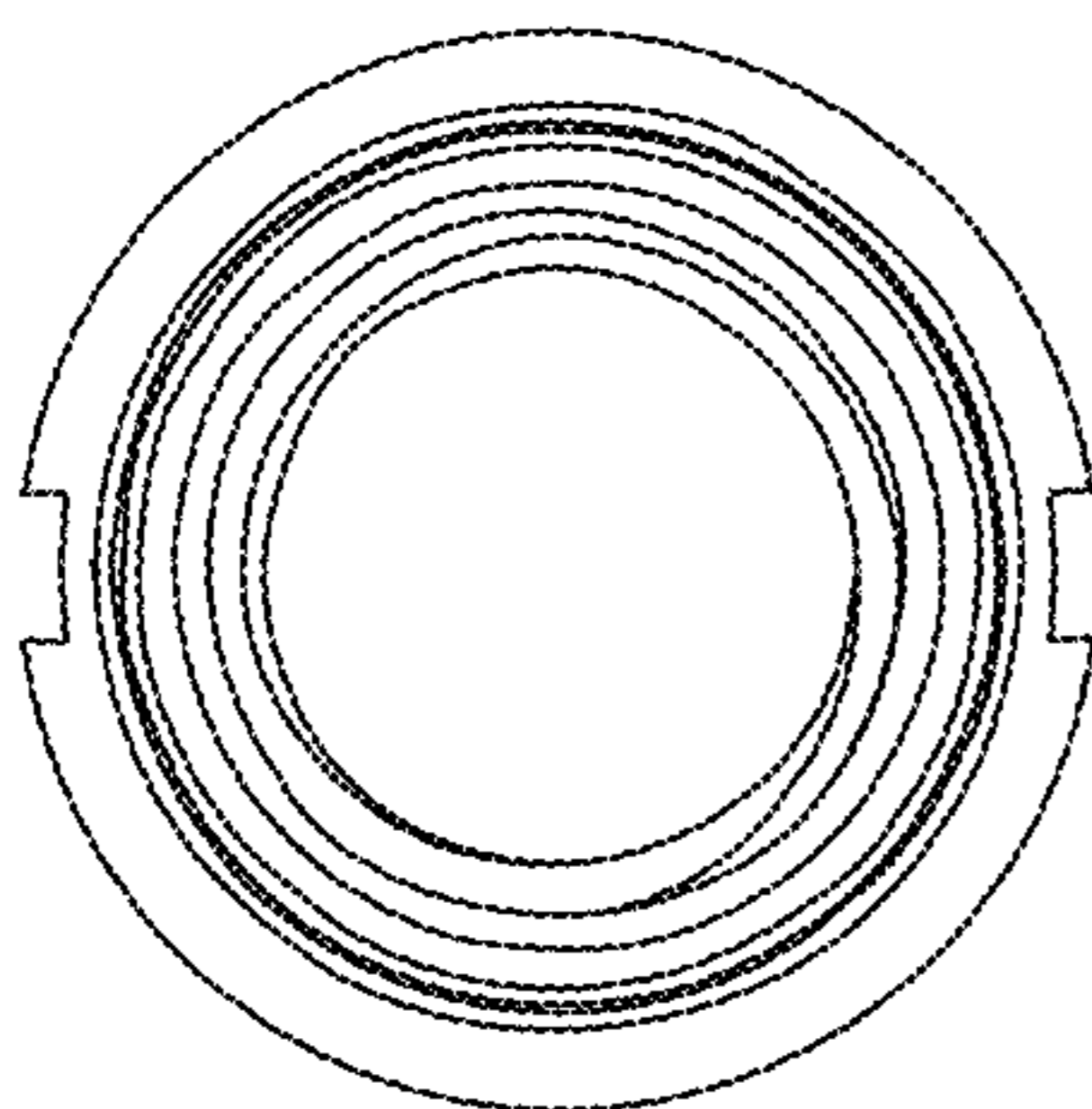

FIG. 10

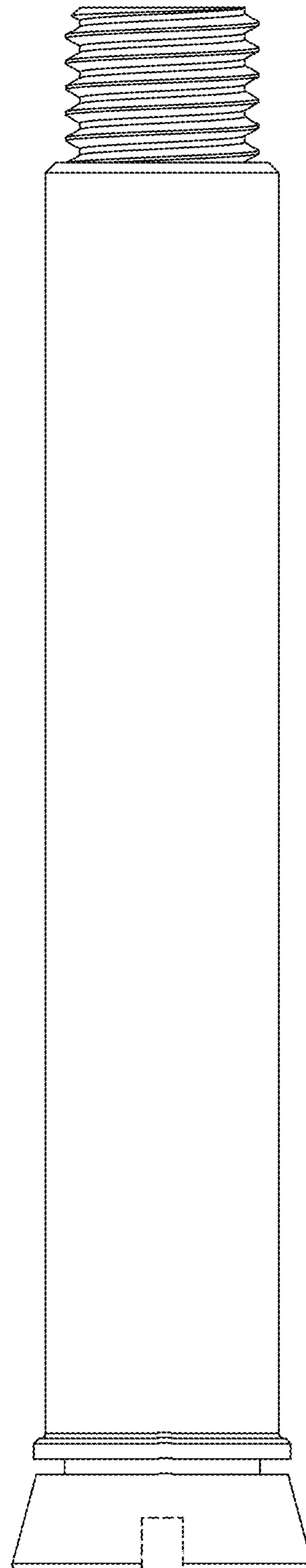

FIG. 11

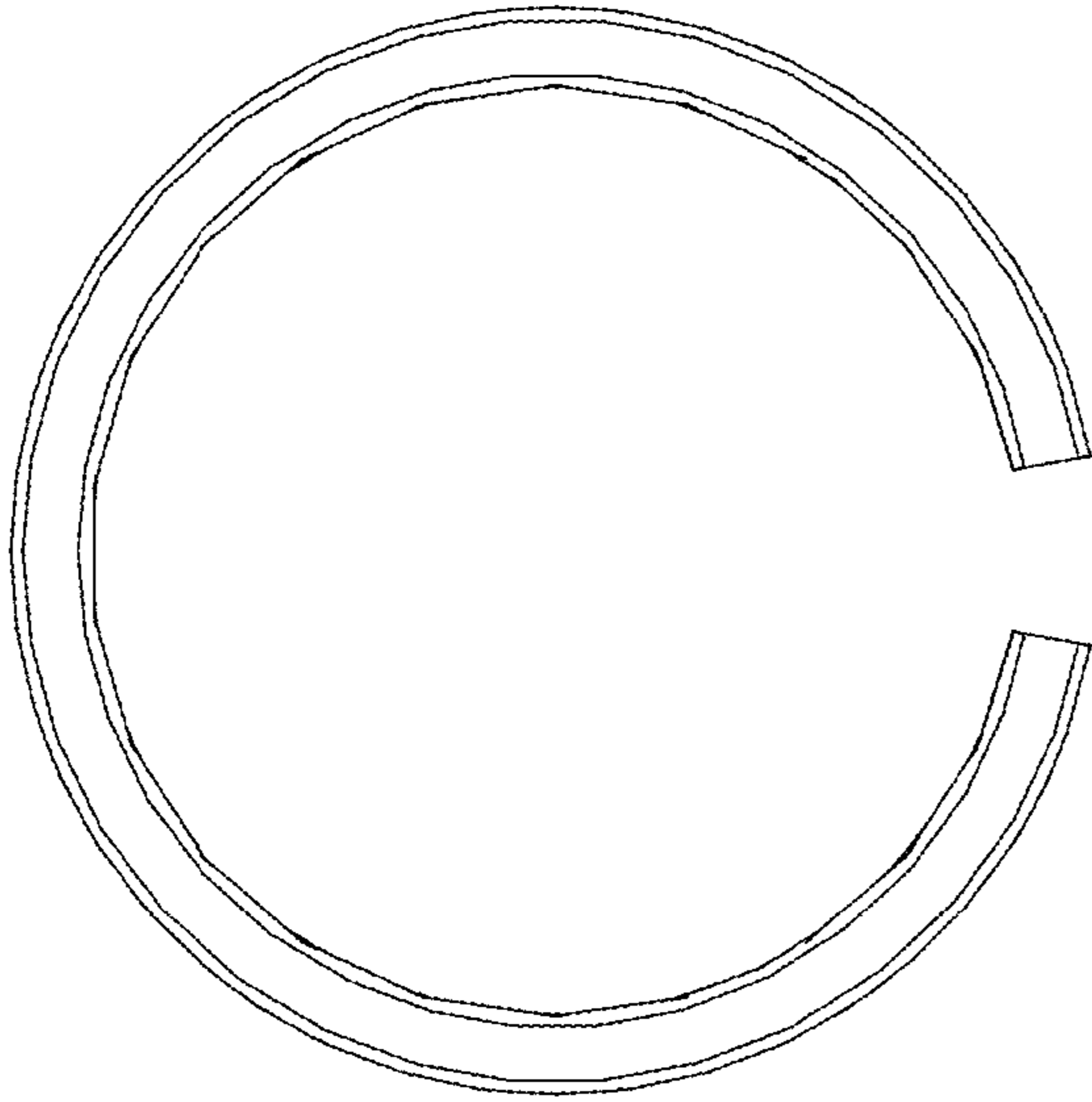

FIG. 12

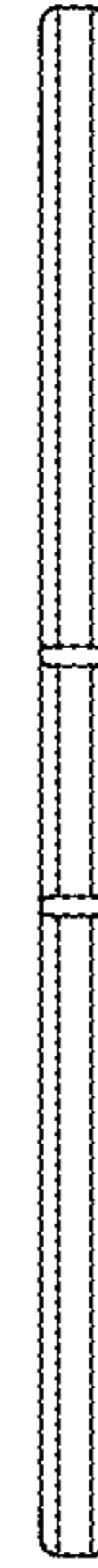

FIG. 13

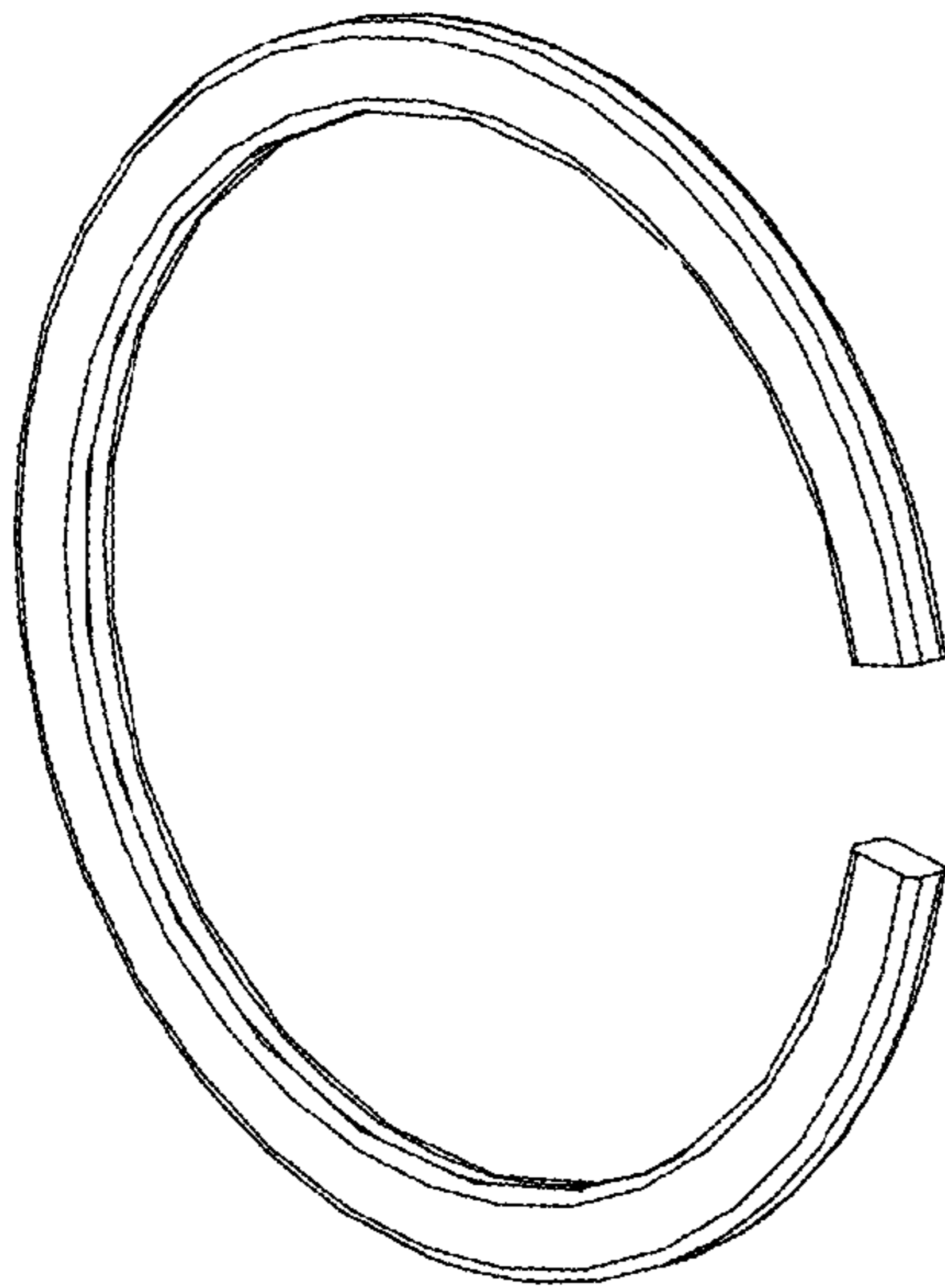

FIG. 14

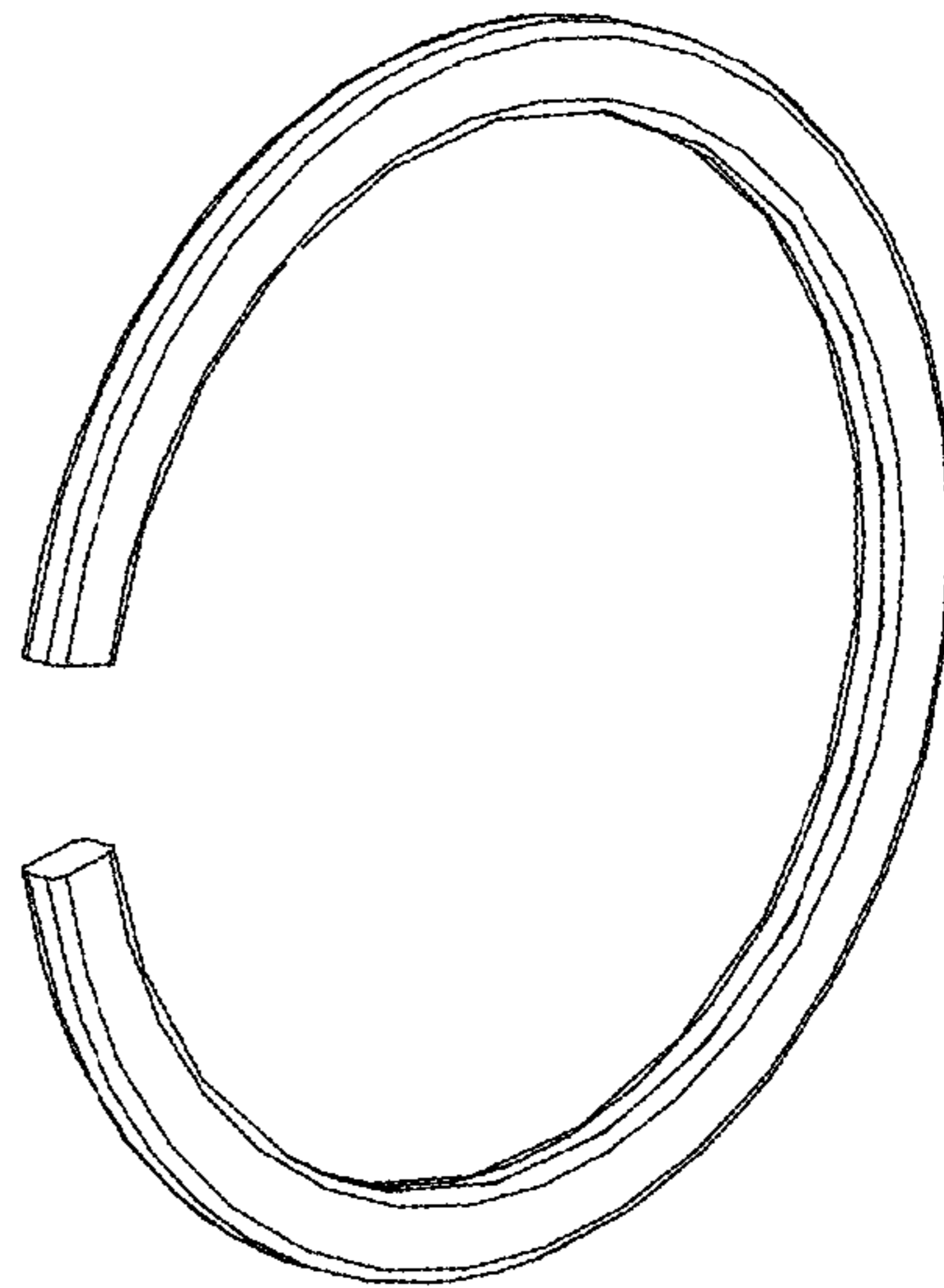

FIG. 15

