



US00D770765S

(12) **United States Design Patent** (10) **Patent No.:** **US D770,765 S**  
**Hanson** (45) **Date of Patent:** **\*\* Nov. 8, 2016**

(54) **BOOT HANDBAG**

(71) Applicant: **Betty Hanson**, Katy, TX (US)

(72) Inventor: **Betty Hanson**, Katy, TX (US)

(\*\*) Term: **14 Years**

(21) Appl. No.: **29/525,918**

(22) Filed: **May 5, 2015**

(51) **LOC (10) Cl.** ..... **03-01**

(52) **U.S. Cl.**  
USPC ..... **D3/238**

(58) **Field of Classification Search**  
USPC ..... D3/234, 238; D2/909–910  
CPC ..... A45C 1/024; A45C 3/06  
See application file for complete search history.

(56) **References Cited**

U.S. PATENT DOCUMENTS

D118,430 S *	1/1940	Doree	.....	D2/984
D165,540 S *	12/1951	Neal	.....	D2/900
D198,307 S *	6/1964	Cohn	.....	D2/910
D251,574 S *	4/1979	Molinari	.....	D3/238

(Continued)

*Primary Examiner* — Holly Baynham

(74) *Attorney, Agent, or Firm* — Karen B. Tripp

(57) **CLAIM**

The ornamental design for a boot handbag, as shown and described.

**DESCRIPTION**

FIG. 1 is a perspective view of an embodiment of a boot handbag configured in accordance with the present invention, wherein the handbag is shown closed, and the toe of the

boot-appearing portion of the handbag has a rounded “toe” shape, and the handle has a solid and relatively smooth configuration.

FIG. 2 is a front view of the handbag of FIG. 1.

FIG. 3 is a back view of the handbag of FIG. 1.

FIG. 4 is a right side view of the handbag of FIG. 1.

FIG. 5 is a left side view of the handbag of FIG. 1.

FIG. 6 is a top view of the handbag of FIG. 1.

FIG. 7 is a bottom view of the handbag of FIG. 1.

FIG. 8 is a perspective view of an alternative embodiment of a boot handbag configured in accordance with the present invention, wherein the handbag is shown closed, the toe of the boot-appearing portion of the handbag has a pointed “toe” shape, the handle has a chain type configuration which optionally may have ribbon, leather, or fabric woven there-through, and straps are positioned across and around the near-middle, central, or “ankle” section of the boot-appearing portion of the handbag for placement of charms, bling, or similar decoration.

FIG. 9 is a front view of the handbag of FIG. 8.

FIG. 10 is a back view of the handbag of FIG. 8.

FIG. 11 is a right side view of the handbag of FIG. 8.

FIG. 12 is a left side view of the handbag of FIG. 8.

FIG. 13 is a top view of the handbag of FIG. 8.

FIG. 14 is a bottom view of the handbag of FIG. 8. s a perspective view of an embodiment of shorts or jean shorts configured in accordance with the present invention, wherein the shorts are fastened or closed.

FIG. 15 is a perspective view of a third embodiment of a boot handbag configured in accordance with the present invention, wherein the handbag is shown closed, and is like the handbag of FIG. 8 except that the handle is like that of the handbag of FIG. 1; and,

FIG. 16 is a perspective view of a fourth embodiment of a boot handbag configured in accordance with the present invention, wherein the handbag is shown closed, and is like the handbag of FIG. 1 except that the handle is like that of the handbag of FIG. 8.

**1 Claim, 11 Drawing Sheets**

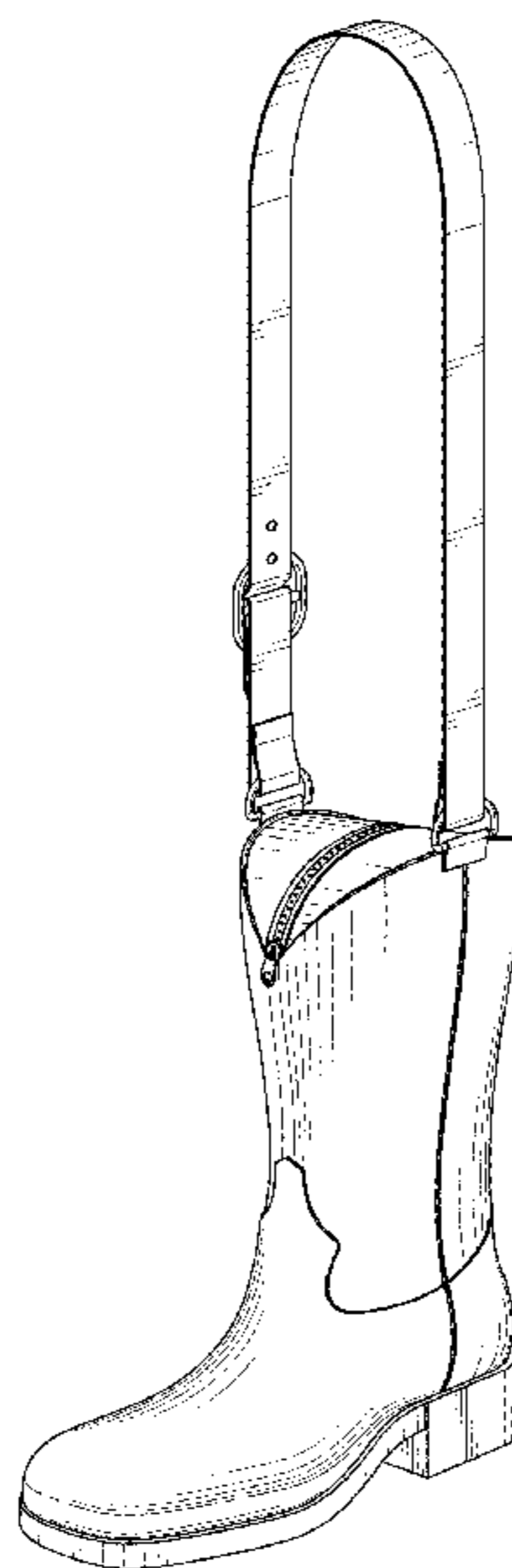

(56)

**References Cited**

U.S. PATENT DOCUMENTS

D251,575 S \* 4/1979 Molinari ..... D3/238  
D322,513 S \* 12/1991 Berger ..... D2/902  
D344,626 S \* 3/1994 Landa ..... D3/236  
D468,097 S \* 1/2003 Landa ..... D3/238

D525,016 S \* 7/2006 Feller ..... D2/909  
D536,170 S \* 2/2007 Elson ..... D3/238  
D547,931 S \* 8/2007 Thorp ..... D2/909  
D665,165 S \* 8/2012 Brazzell ..... D3/234  
D671,313 S \* 11/2012 Brazzell ..... D3/234

\* cited by examiner

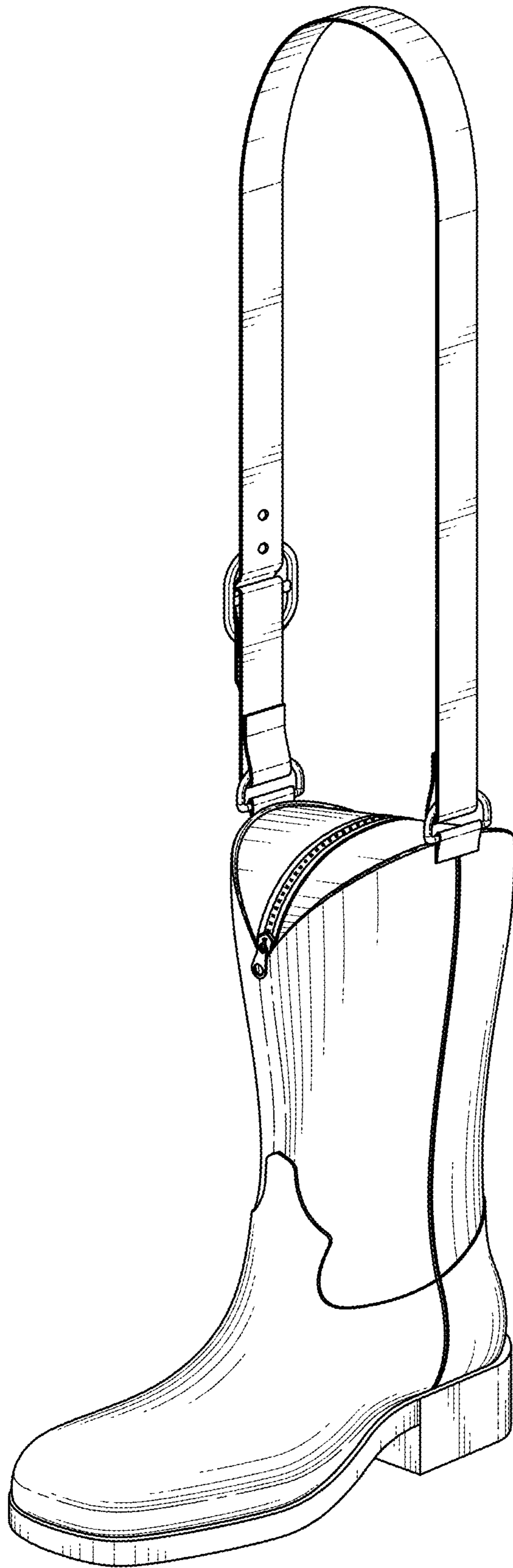

FIG. 1

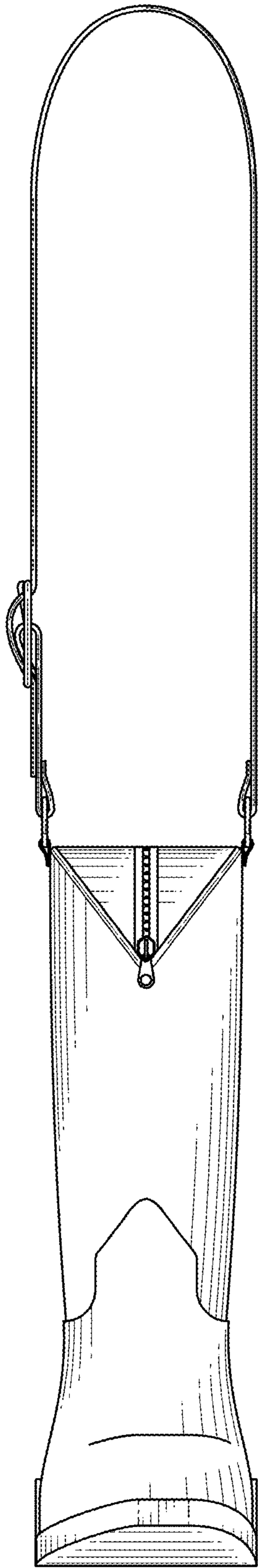

FIG. 2

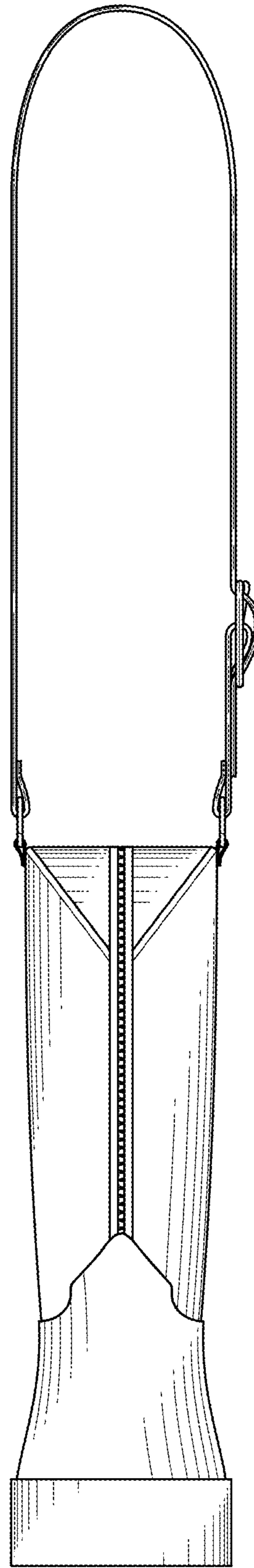

FIG. 3

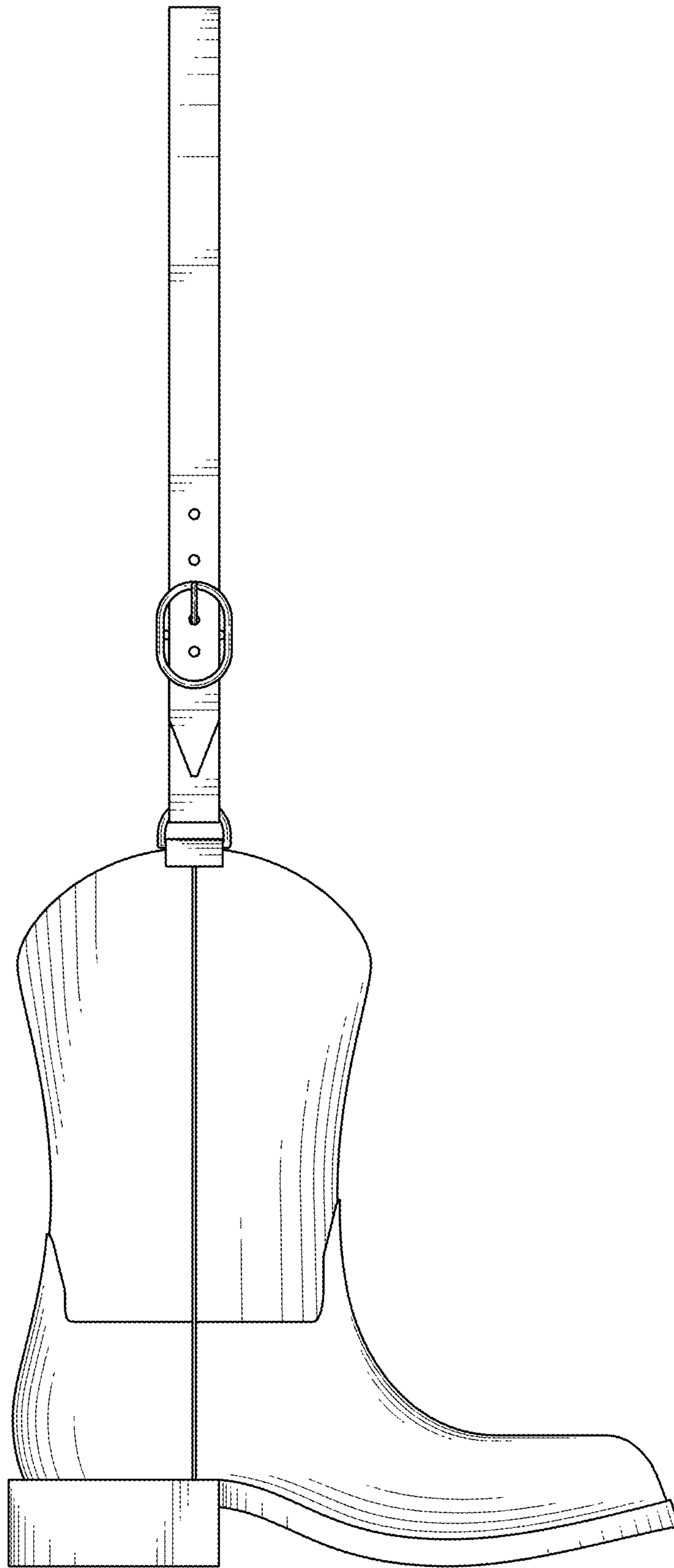

FIG. 4

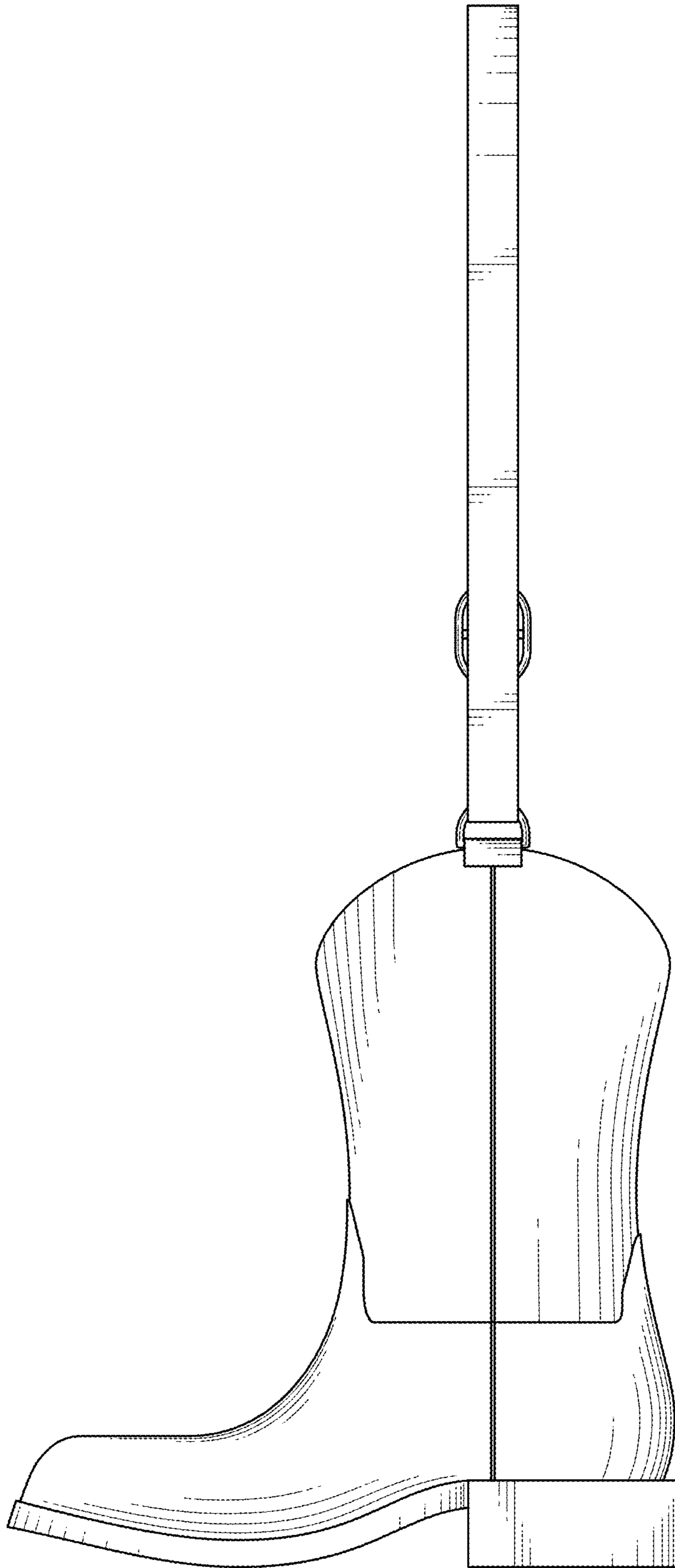

FIG. 5

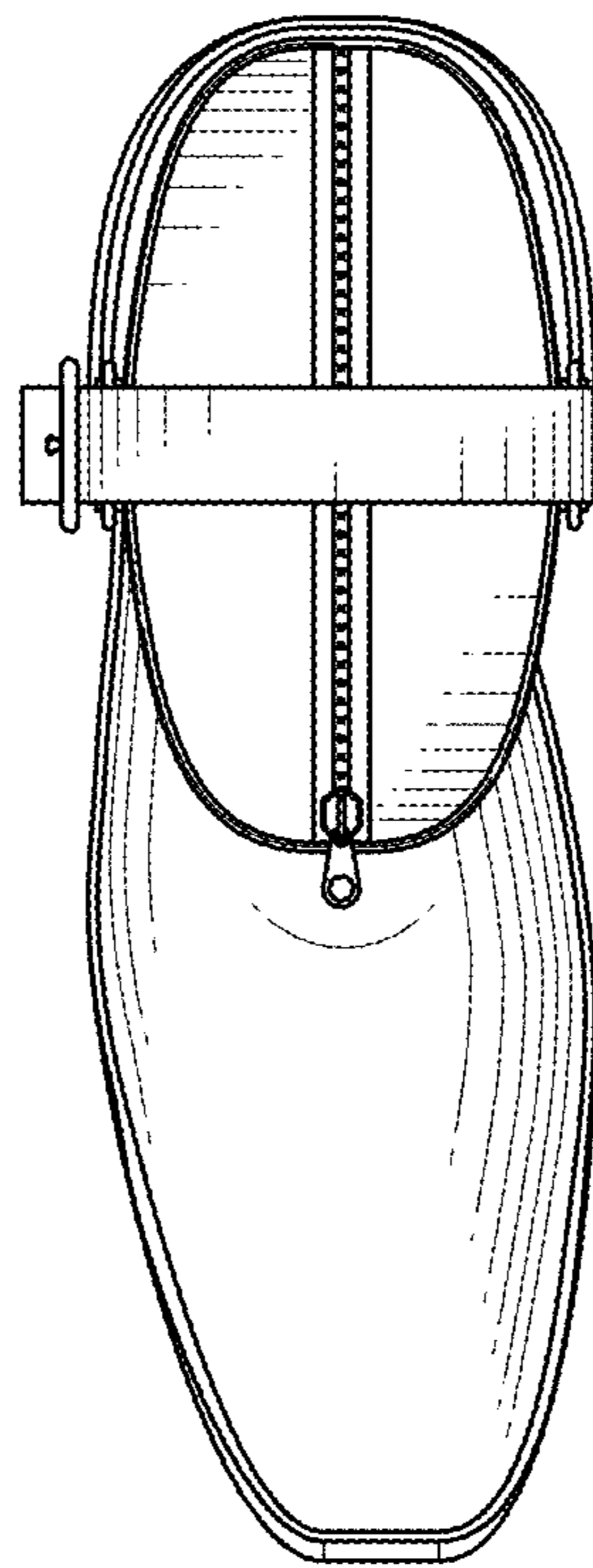

FIG. 6

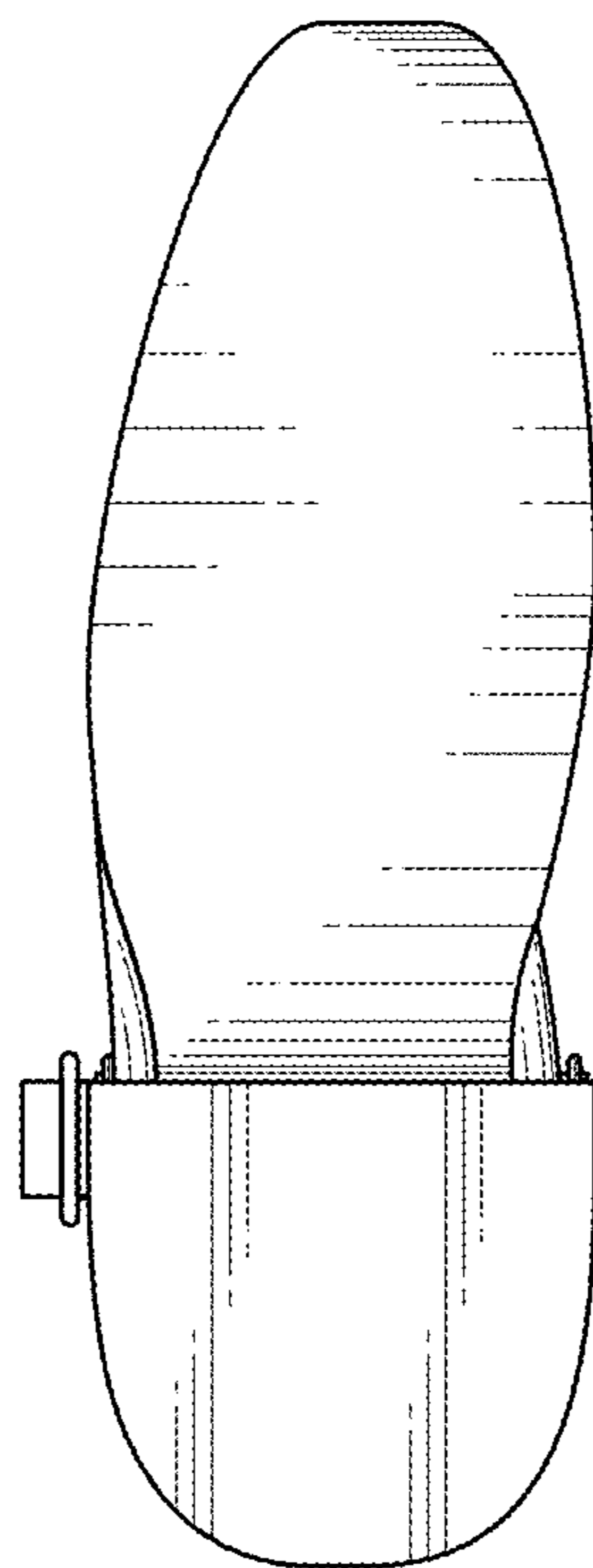

FIG. 7

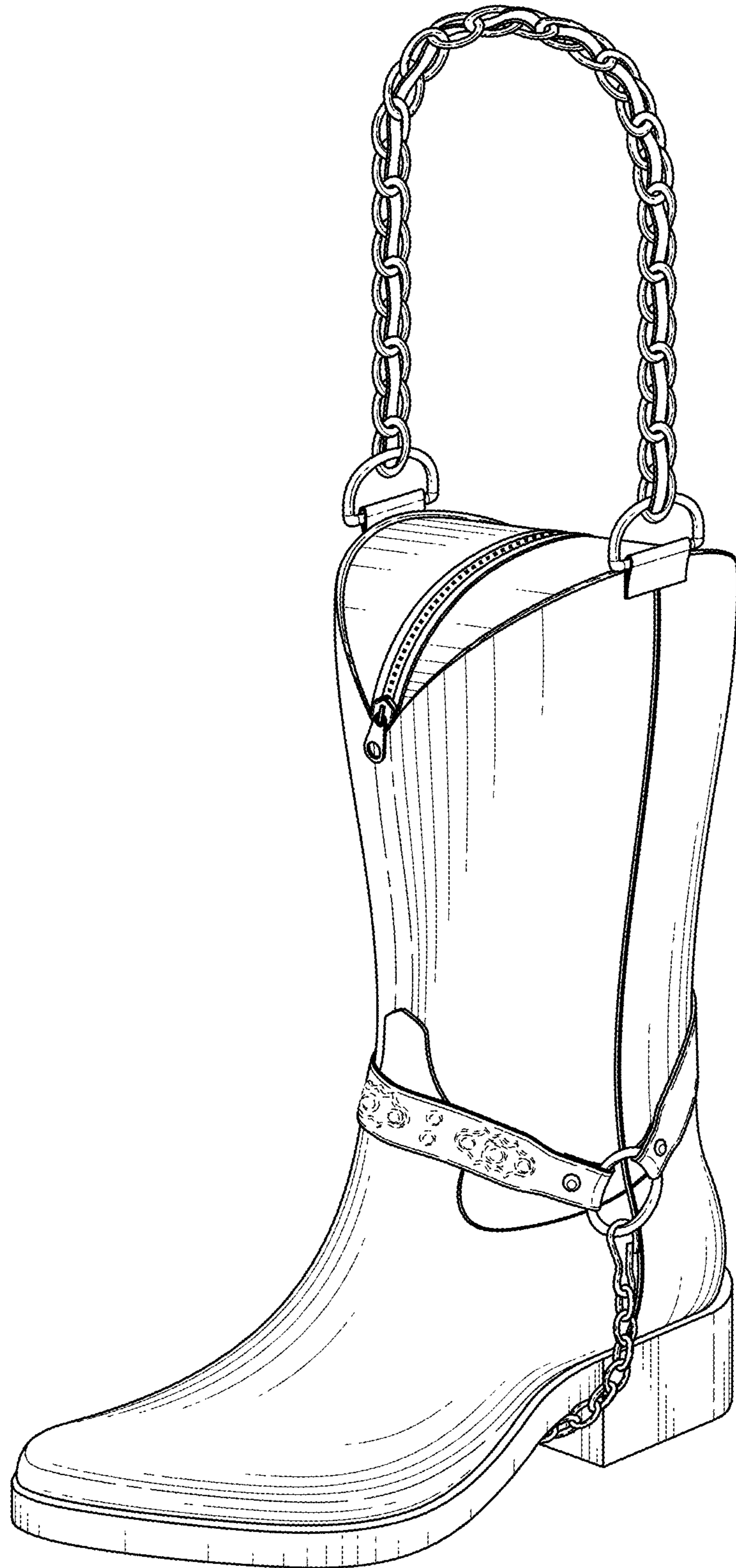

FIG. 8



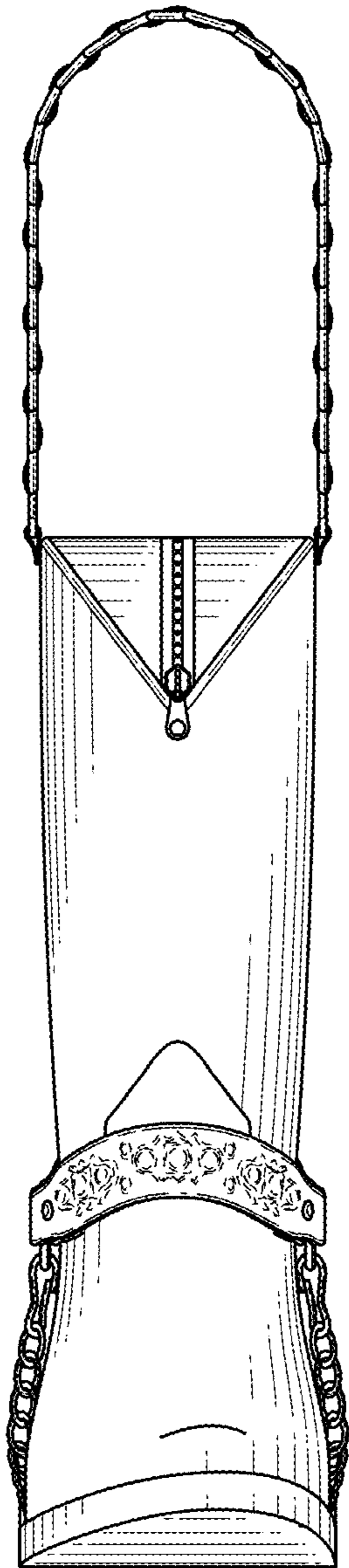

FIG. 9

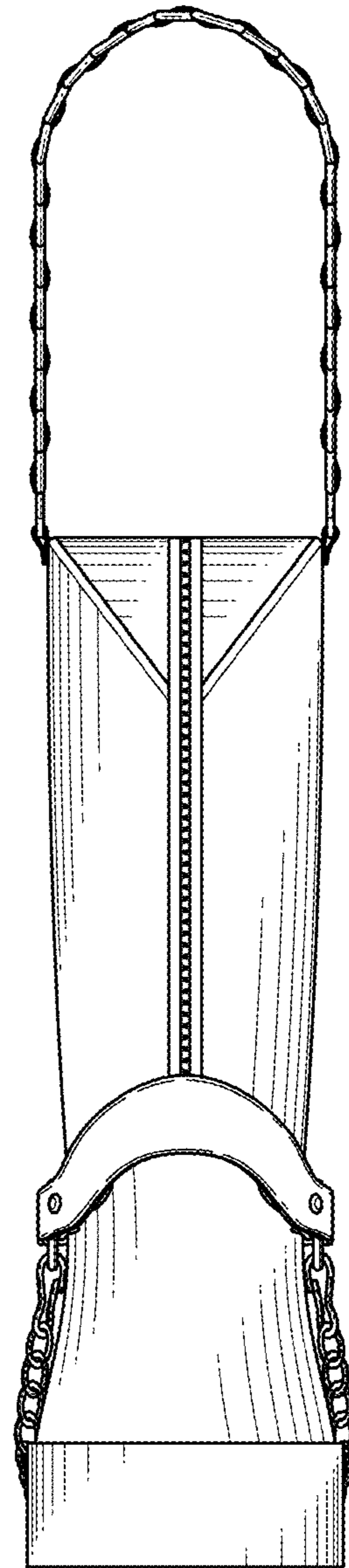

FIG. 10

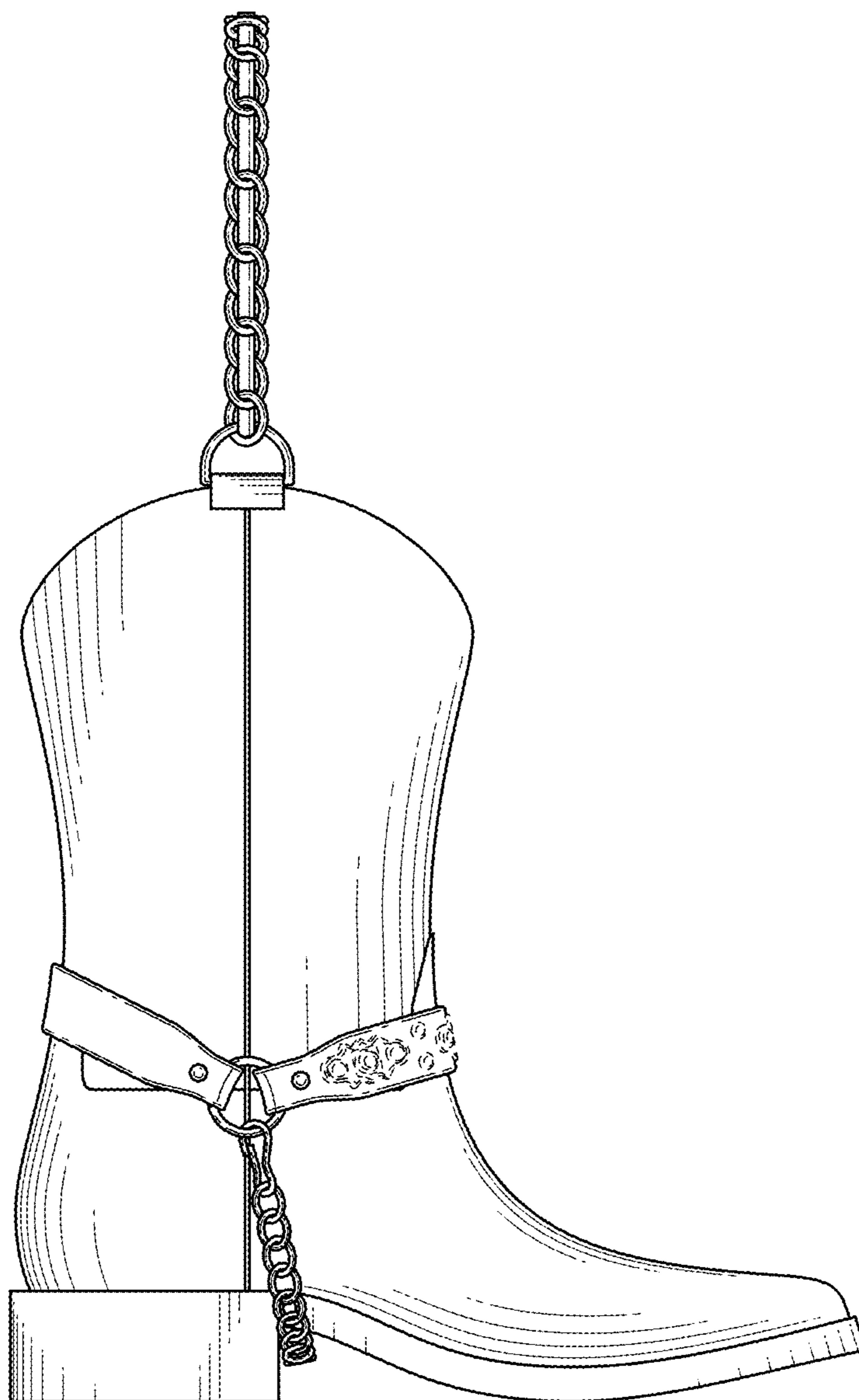

FIG. 11

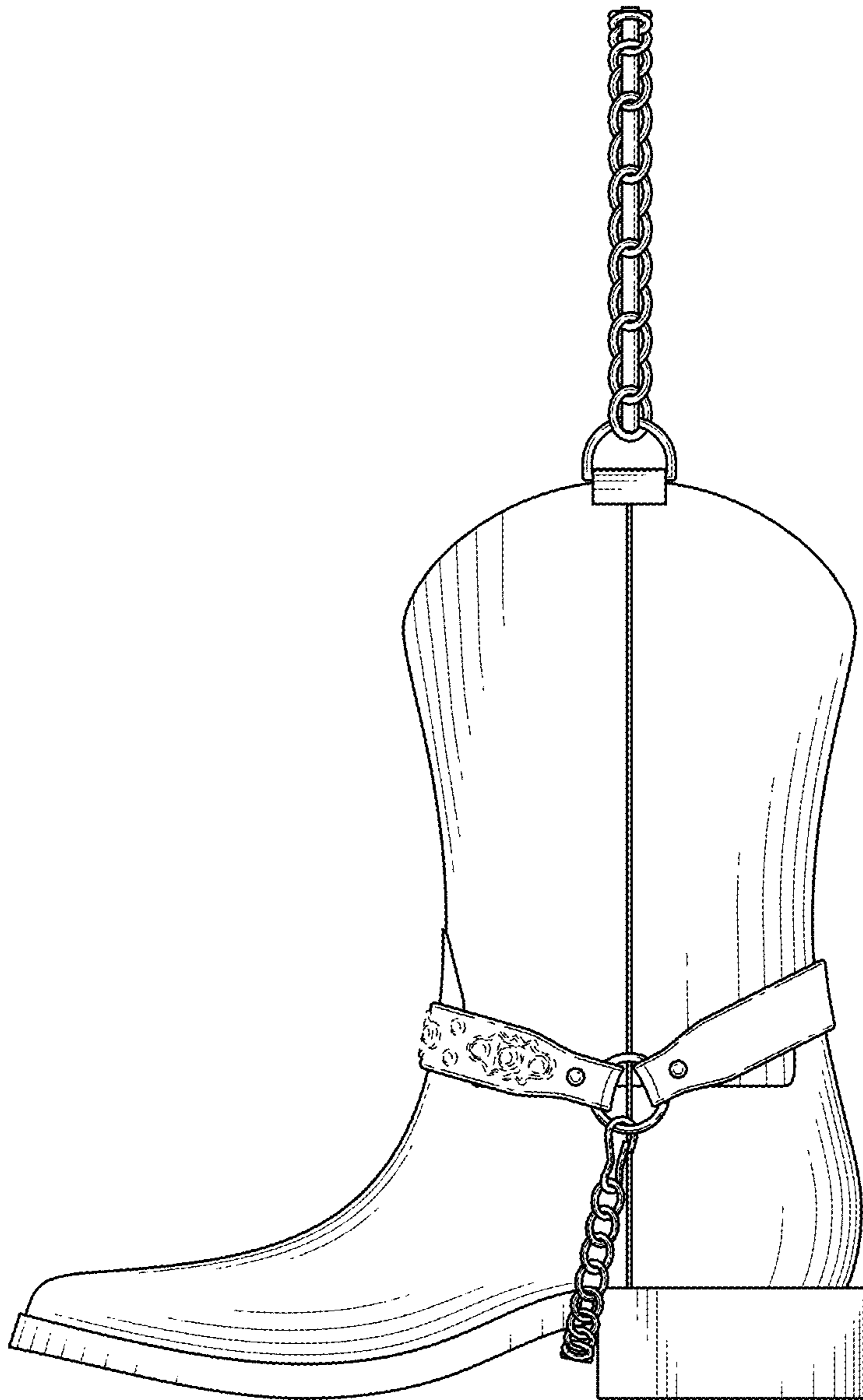

FIG. 12

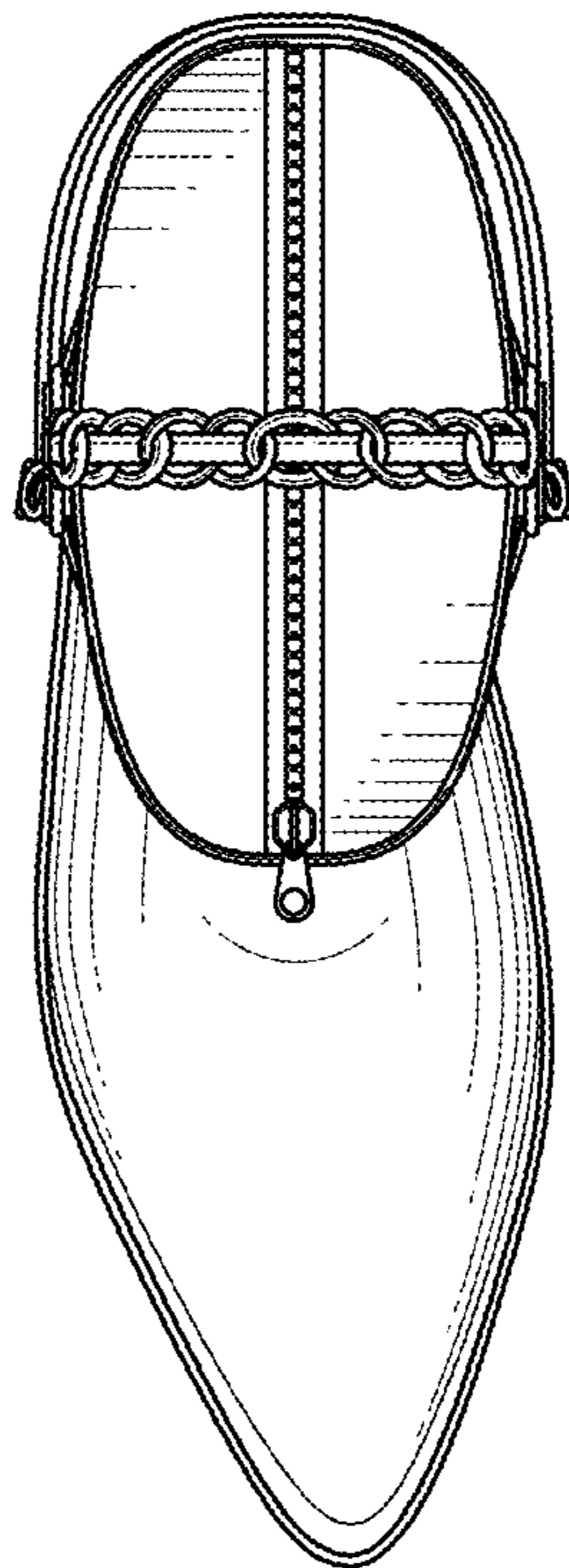

FIG. 13

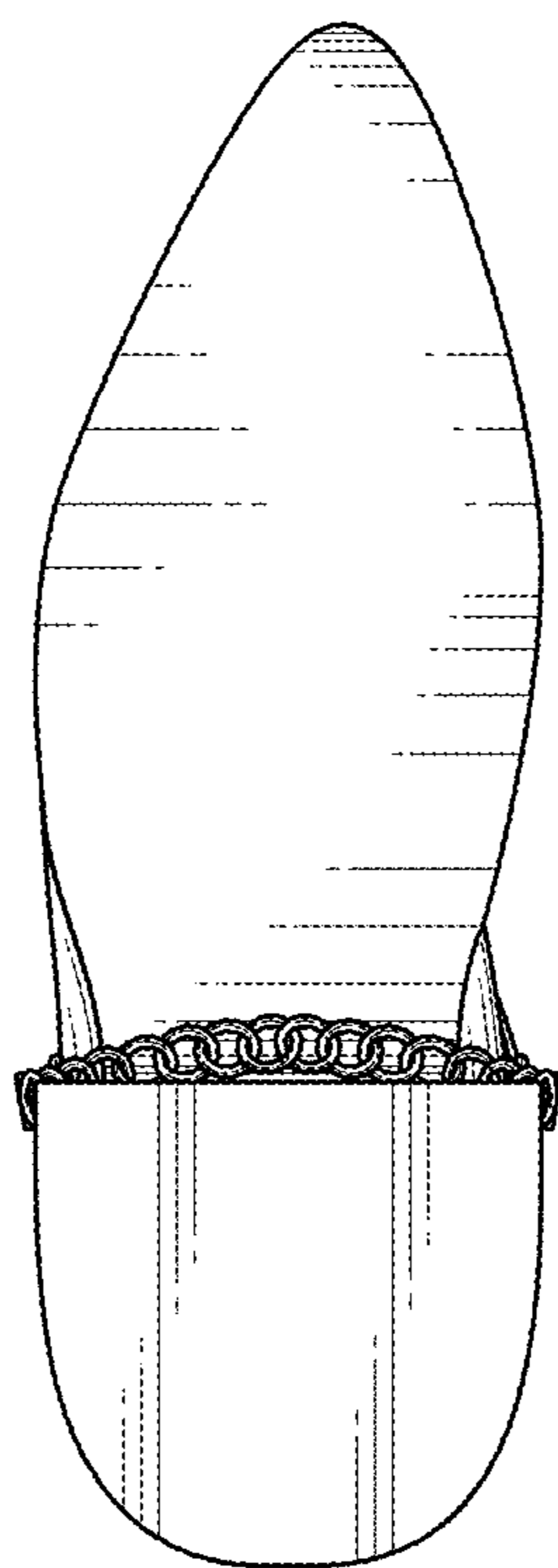

FIG. 14

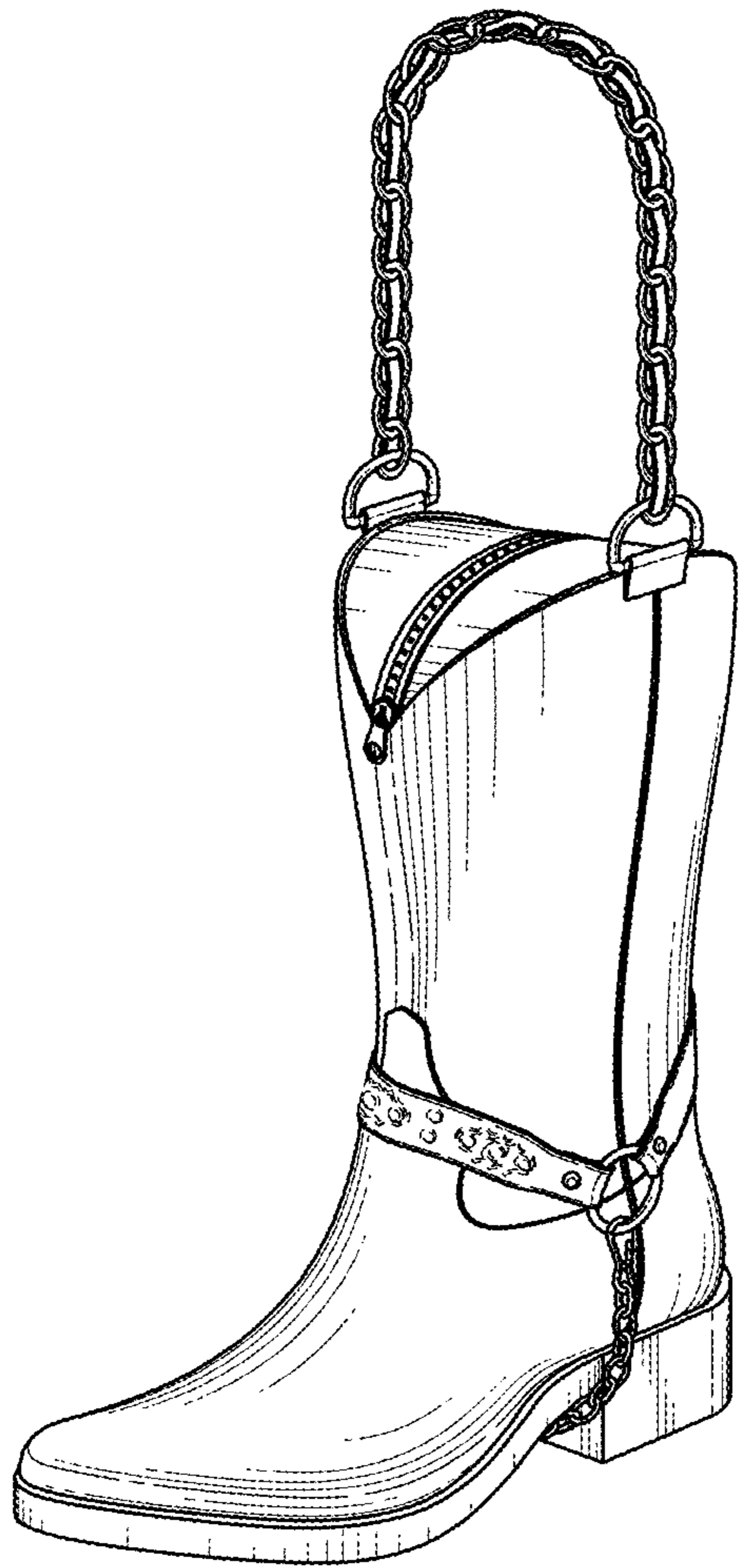

FIG. 15

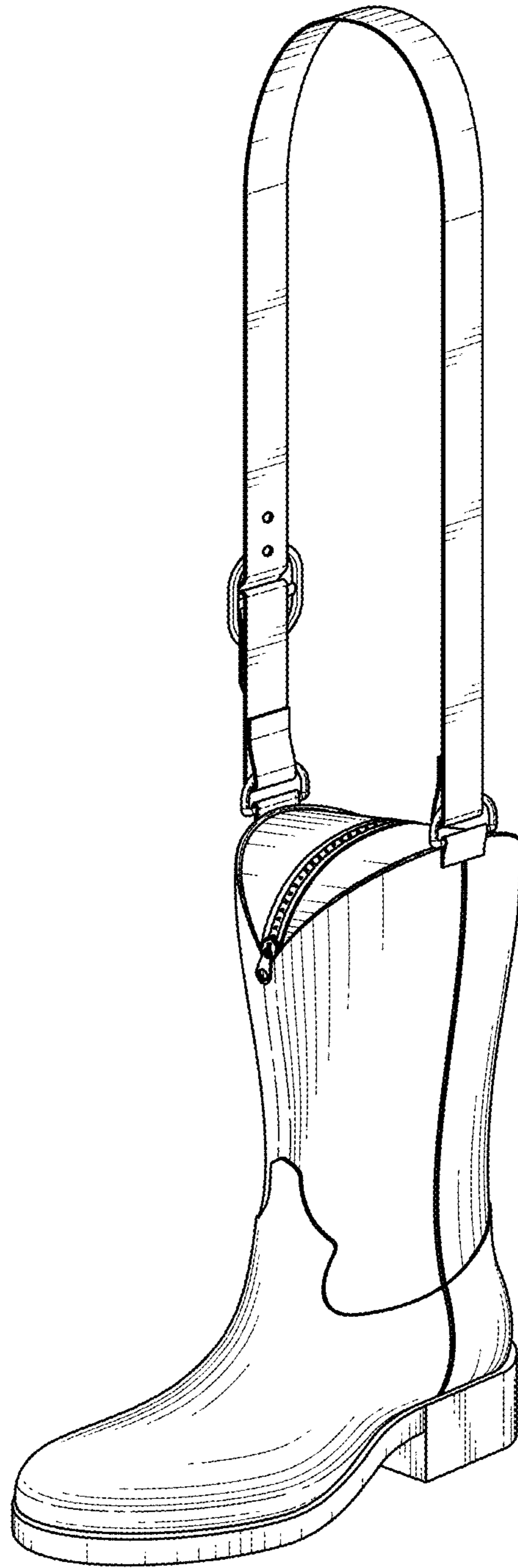

FIG. 16