



US00D770685S

(12) **United States Design Patent** (10) **Patent No.:** **US D770,685 S**
Teller et al. (45) **Date of Patent:** **** *Nov. 1, 2016**

(54) **COSMETIC PRODUCT CONTAINER**

(71) Applicant: **EOS PRODUCTS, LLC**, New York, NY (US)

(72) Inventors: **Jonathan Teller**, New York, NY (US);
Sanjiv Mehra, New York, NY (US);
Peter Waxman, New York, NY (US);
Joseph Speter, New York, NY (US);
Sherry Jhawar, New York, NY (US);
Hamish Campbell, New York, NY (US)

(73) Assignee: **EOS PRODUCTS, LLC**, New York, NY (US)

(*) Notice: This patent is subject to a terminal disclaimer.

(**) Term: **14 Years**

(21) Appl. No.: **29/488,093**

(22) Filed: **Apr. 15, 2014**

(51) **LOC (10) Cl.** **28-03**

(52) **U.S. Cl.**
USPC **D28/82**; D28/88; D9/519; D9/554;
D9/551

(58) **Field of Classification Search**

USPC D28/85-91, 82, 76-79, 4-7, 8.1, 8.2, 9;
D9/502, 570, 503, 504, 519, 552, 554,
D9/557, 564, 566, 567, 600, 726, 601, 551,
D9/521, 416, 529, 438, 435; D24/101,
D24/102; D1/127, 130; D5/43, 44, 56, 59,
D5/60, 62, 55; 132/316, 317, 318, 320;
206/581, 823, 385; D3/265, 270,
D3/271.1; 424/467; D14/489
CPC B65D 1/00; B65D 3/00; B65D 5/00;
B65D 11/00; B65D 25/00; B65D 81/00
See application file for complete search history.

(56) **References Cited**

U.S. PATENT DOCUMENTS

1,852,455 A 4/1932 Friedman
2,745,642 A * 5/1956 Hermann 366/130
3,167,079 A * 1/1965 Weil 134/137

(Continued)

FOREIGN PATENT DOCUMENTS

JP 1136041 S 3/2002
JP 2001321140 A 11/2004

OTHER PUBLICATIONS

SIPO Office Action issued Jul. 17, 2014 in connection with CN Appl. No. 201080063211.X citing JP 2004-321410A and JP 1136041S.

Primary Examiner — Marianne Pandozzi

Assistant Examiner — Jae Liang

(74) *Attorney, Agent, or Firm* — Martin & Ferraro, LLP

(57) **CLAIM**

The ornamental design for a cosmetic product container, as shown and described.

DESCRIPTION

FIG. 1 is a front elevational view of a cosmetic product container showing my new design; FIG. 2 is a left side elevational view thereof; FIG. 3 is a right side elevational view thereof; FIG. 4 is a rear elevational view thereof; FIG. 5 is a top plan view thereof; and, FIG. 6 is a bottom plan view thereof. The broken lines in the drawing depict portions of the cosmetic product container that form no part of the claimed design. The stippling in FIGS. 1-6 shows contrast in appearance.

1 Claim, 3 Drawing Sheets

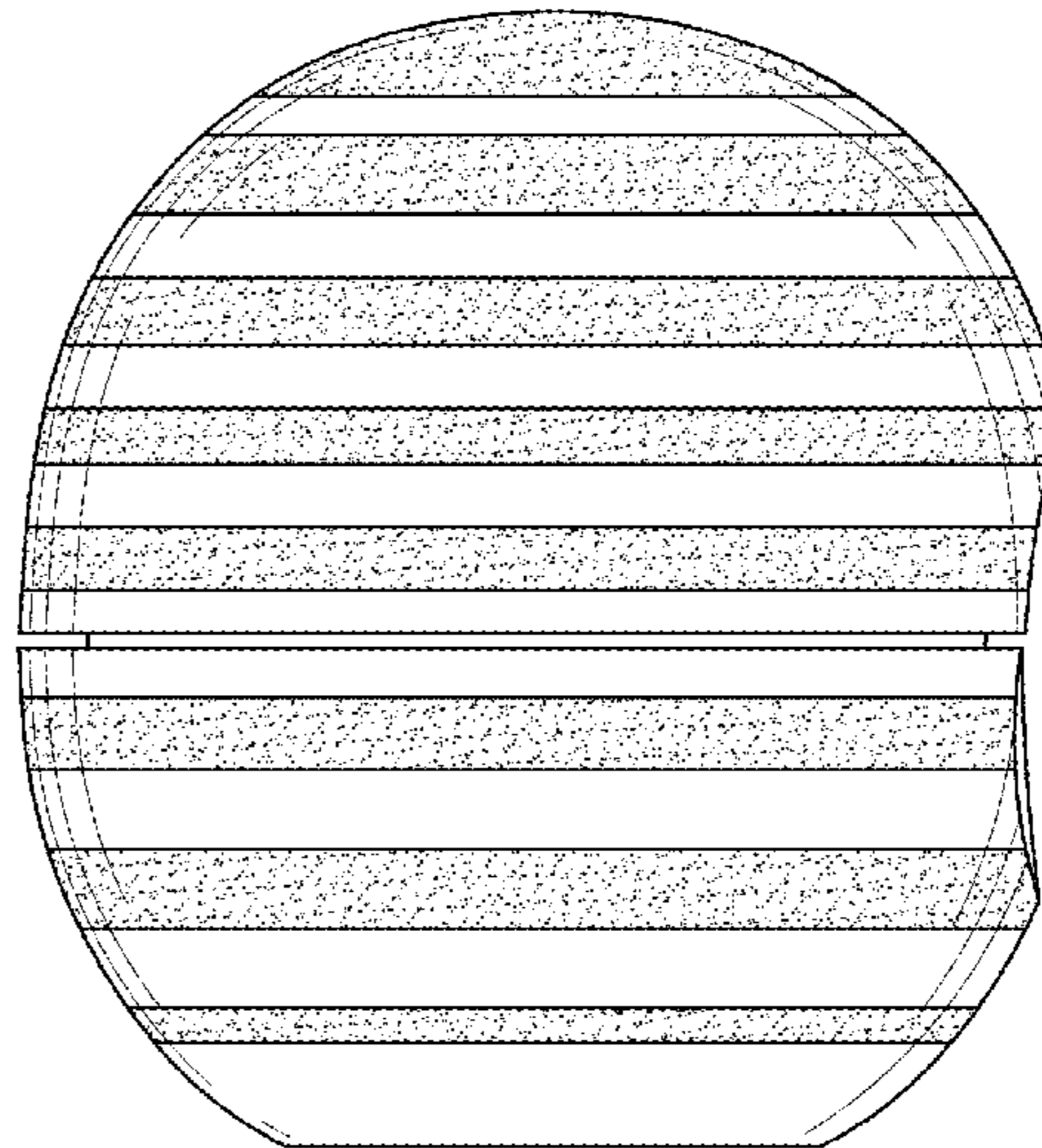
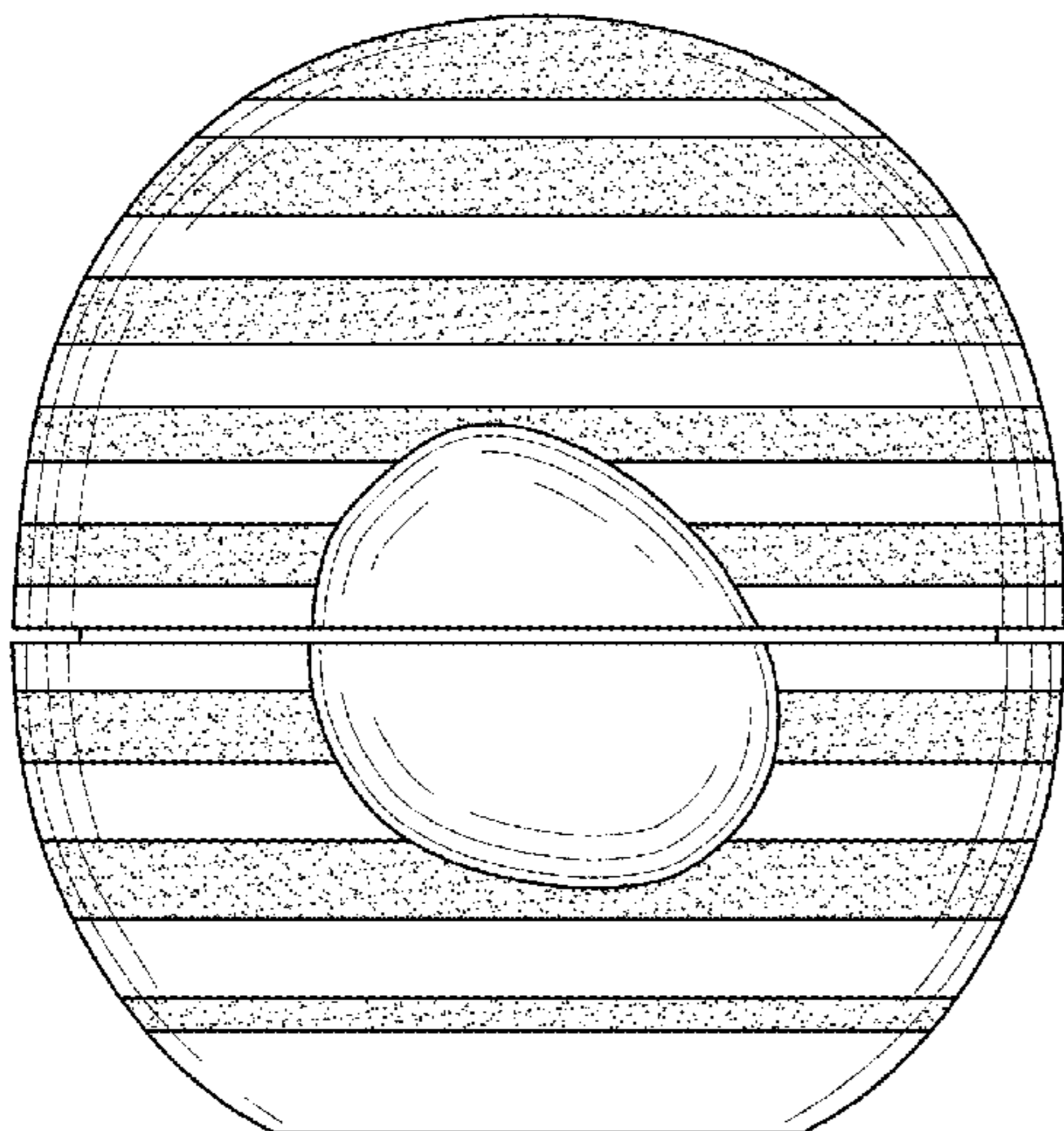

(56)

References Cited

U.S. PATENT DOCUMENTS

D206,463 S * 12/1966 Federighi D9/502
5,044,496 A 9/1991 Tanaka
D321,129 S * 10/1991 Giuseppe D9/502
D380,672 S * 7/1997 Rowe D9/669
D382,207 S * 8/1997 Rowe D9/636
6,193,427 B1 2/2001 Benguigui
6,391,972 B1 5/2002 Hatakeyama
D474,021 S * 5/2003 Lenaerts D3/302

D521,868 S * 5/2006 Arima D9/502
D625,469 S * 10/2010 Dubitsky et al. D28/84
D635,371 S * 4/2011 Schilling et al. D5/60
D644,939 S * 9/2011 Teller D9/726
D656,741 S * 4/2012 Snyder D5/60
8,444,337 B2 * 5/2013 Teller 401/88
D726,219 S * 4/2015 Chaudhri et al. D14/489

* cited by examiner

FIG. 1

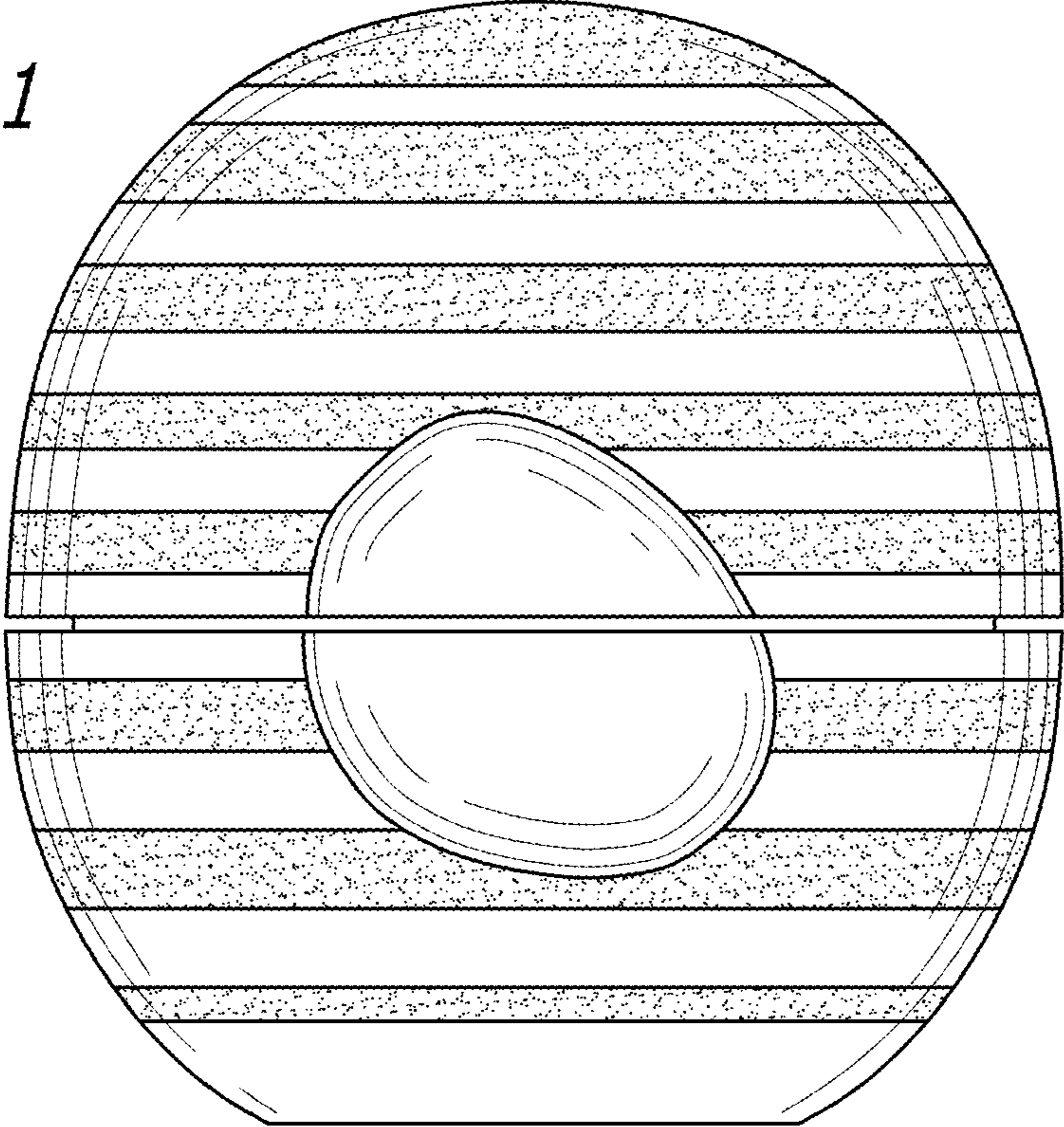

FIG. 2

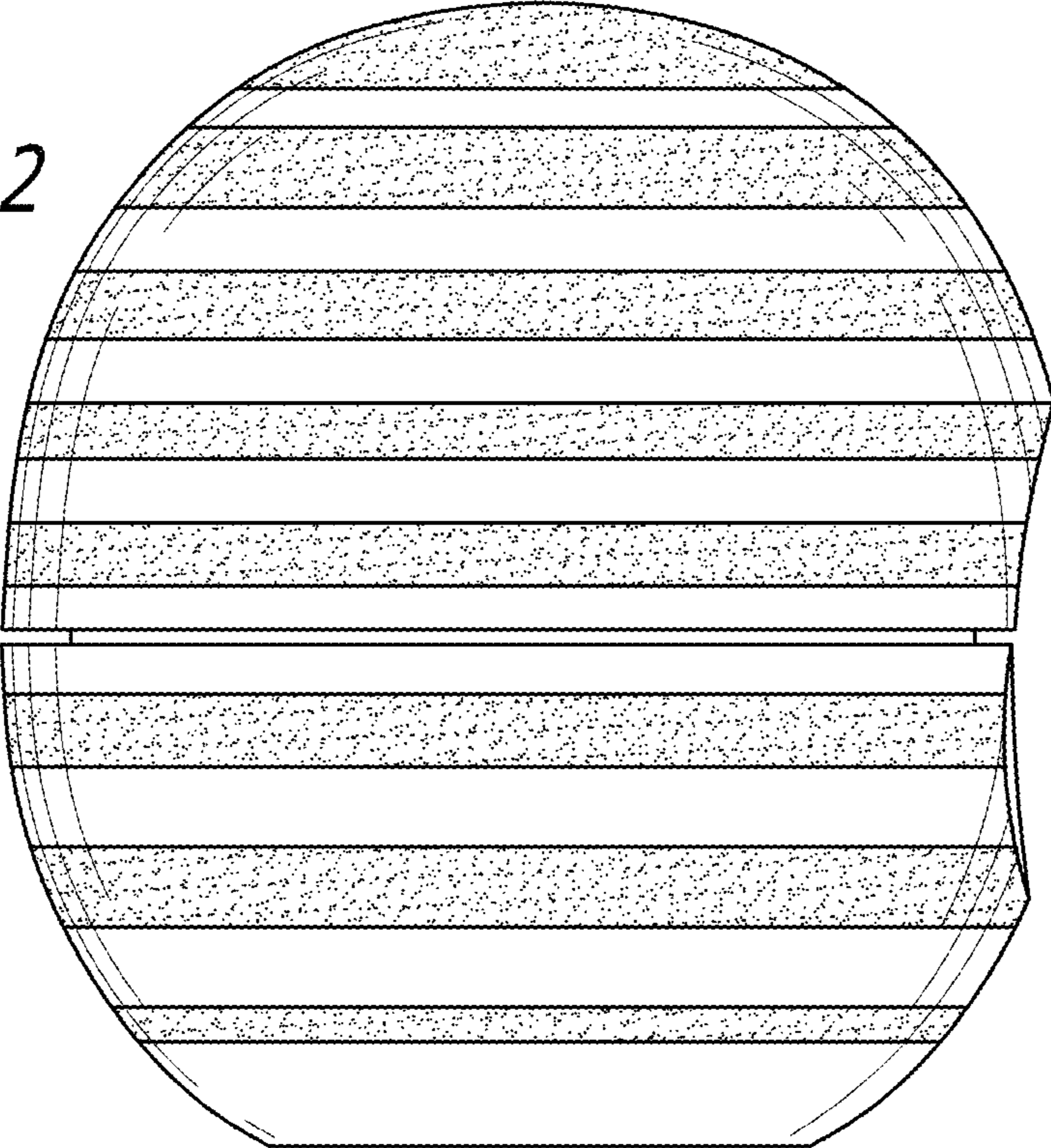

FIG. 3

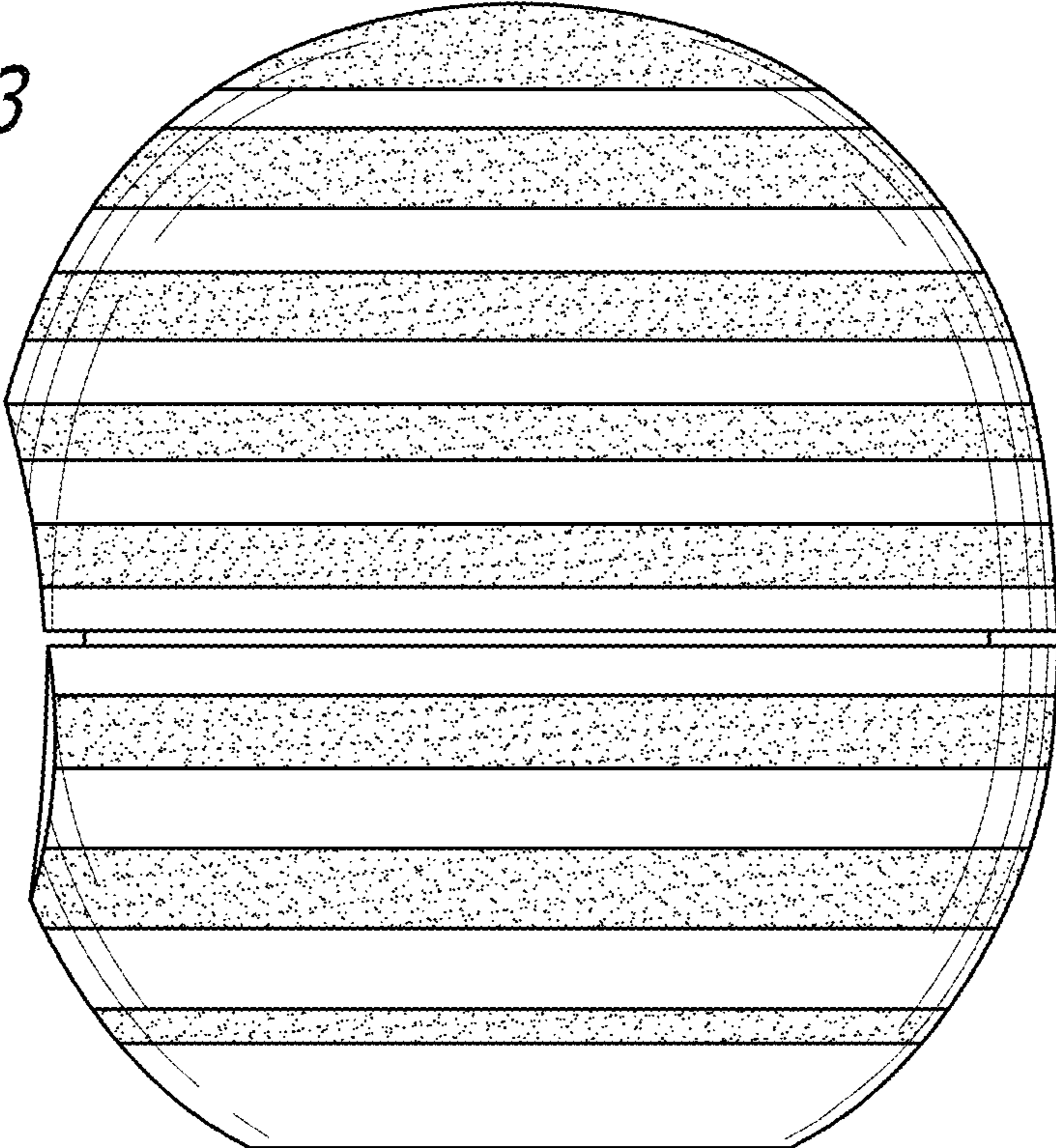

FIG. 4

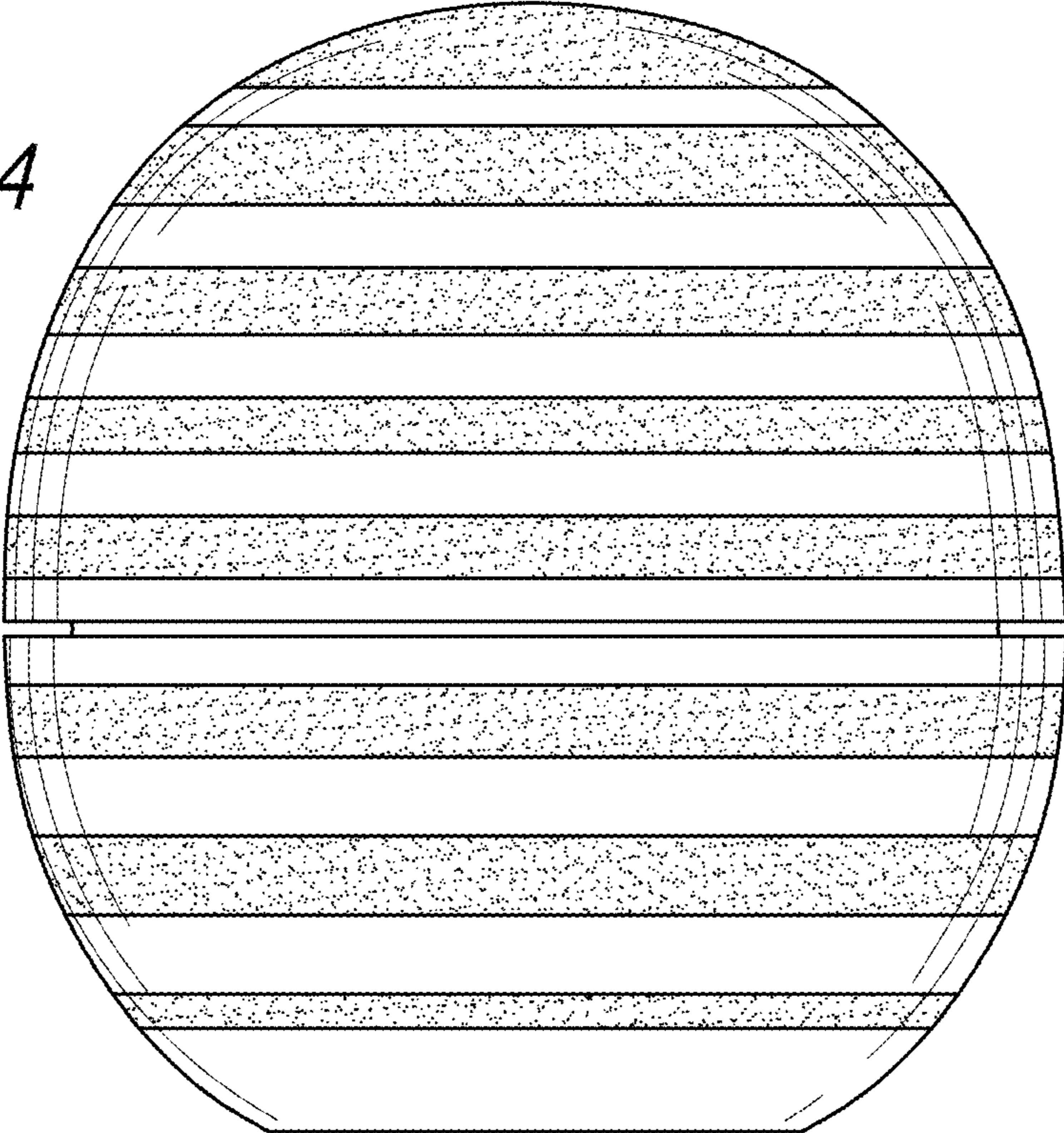

FIG. 5

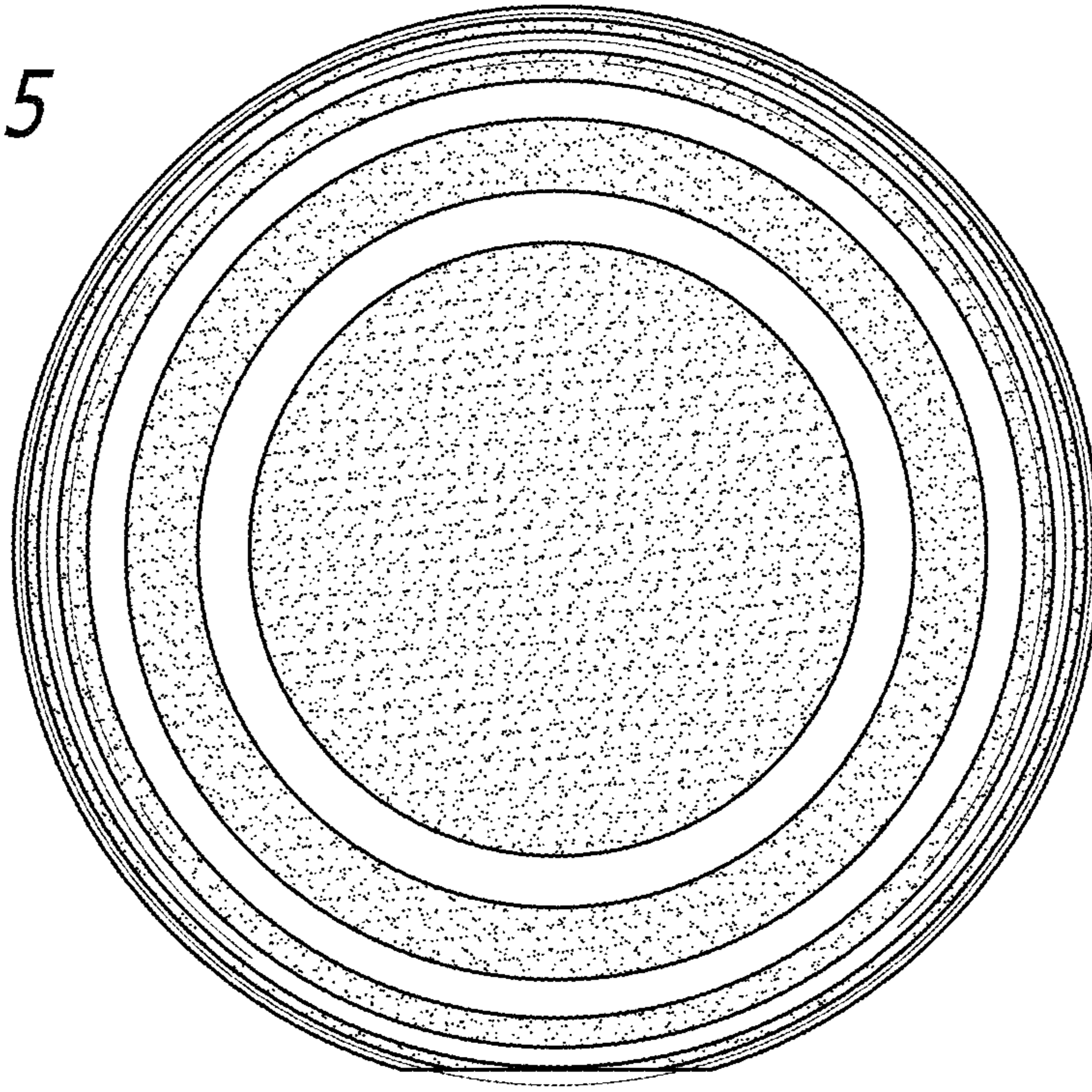

FIG. 6

