



US00D770668S

(12) **United States Design Patent** (10) **Patent No.:** **US D770,668 S**  
**Toms** (45) **Date of Patent:** **\*\* Nov. 1, 2016**

(54) **EXPANDABLE WALL MOUNT LUMINAIRE**  
(71) Applicant: **Hubbell Incorporated**, Shelton, CT (US)  
(72) Inventor: **Shaun Robert Toms**, Fontana, CA (US)  
(73) Assignee: **Hubbell Incorporated**, Shelton, CT (US)  
(\*\*) Term: **14 Years**

*Primary Examiner* — Clare E Heflin  
(74) *Attorney, Agent, or Firm* — Michael Best & Friedrich, LLP

(21) Appl. No.: **29/499,179**

(22) Filed: **Aug. 12, 2014**

**Related U.S. Application Data**

(62) Division of application No. 29/449,873, filed on Mar. 15, 2013, now Pat. No. Des. 713,987.

(51) **LOC (10) Cl.** ..... **26-03**

(52) **U.S. Cl.**  
USPC ..... **D26/92**

(58) **Field of Classification Search**  
USPC ..... D26/71, 72, 85, 87, 92, 118; 362/147, 362/249.02–249.06, 294, 373, 432  
CPC .... F21S 9/03; F21S 8/086; F21W 2131/103; F21V 15/01; F21V 29/02  
See application file for complete search history.

(56) **References Cited**

**U.S. PATENT DOCUMENTS**

|            |        |           |
|------------|--------|-----------|
| D308,261 S | 5/1990 | Shemitz   |
| D323,897 S | 2/1992 | Compton   |
| D329,104 S | 9/1992 | Dieperink |
| D370,544 S | 6/1996 | Compton   |

(Continued)

(57) **CLAIM**  
The ornamental design for an expandable wall mount luminaire, as shown and described.

**DESCRIPTION**

FIG. 1 is a top perspective view of a first embodiment of my design;  
FIG. 2 is a bottom perspective view of my design shown in FIG. 1;  
FIG. 3 is a top view of my design shown in FIG. 1;  
FIG. 4 is a bottom view my design shown in FIG. 1;  
FIG. 5 is a front view of my design shown in FIG. 1;  
FIG. 6 is a right-side view of my design shown in FIG. 1, the left-side view being the mirror image thereof;  
FIG. 7 is a top view of a second embodiment of my design;  
FIG. 8 is a bottom view of my design shown in FIG. 7;  
FIG. 9 is a front view of my design shown in FIG. 7;  
FIG. 10 is a right-side view of my design shown in FIG. 7, the left-side view being the mirror image thereof;  
FIG. 11 is a top view of a third embodiment of my design;  
FIG. 12 is a bottom view of my design shown in FIG. 11;  
FIG. 13 is a front view of my design shown in FIG. 11; and, FIG. 14 is a right-side view of my design shown in FIG. 11, the left-side view being the mirror image thereof.  
The broken lines shown on the drawings depict portions of the luminaire that form no part of the claimed design.  
The luminaire is shown with a symbolic break in its length.  
The appearance of any portion of the article between the break lines forms no part of the claimed design.

**1 Claim, 7 Drawing Sheets**

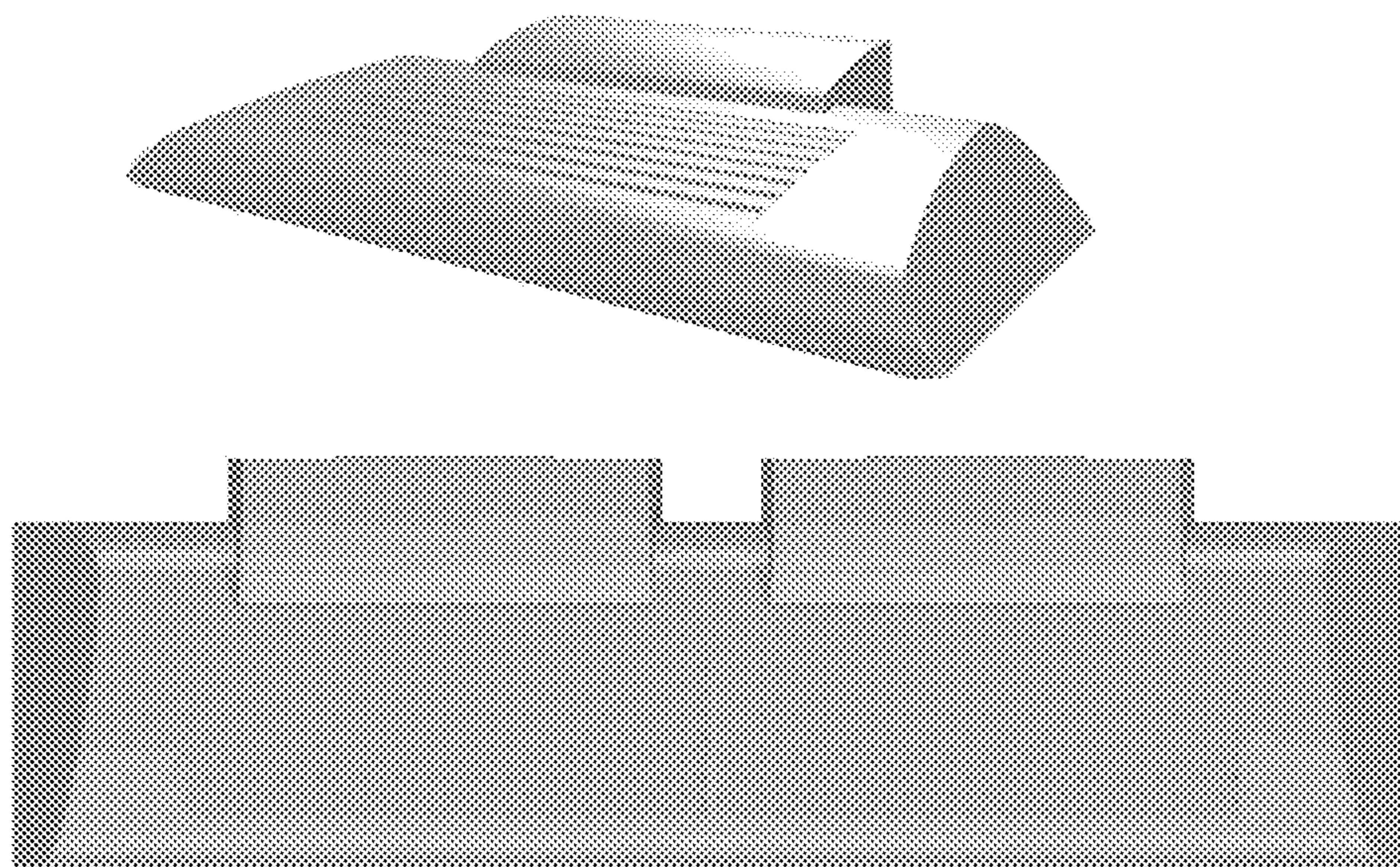

(56)

References Cited

U.S. PATENT DOCUMENTS

|             |         |                   |                 |         |                   |        |
|-------------|---------|-------------------|-----------------|---------|-------------------|--------|
| 5,655,833 A | 8/1997  | Raczynski         | 8,232,745 B2    | 7/2012  | Chemel            |        |
| D406,916 S  | 3/1999  | Klaus             | D670,021 S      | 10/2012 | Ahrari et al.     |        |
| D427,340 S  | 6/2000  | Beghelli          | D671,251 S      | 11/2012 | Piegras et al.    |        |
| D442,313 S  | 5/2001  | Wojtkowiak et al. | D672,903 S      | 12/2012 | Toney, Jr. et al. |        |
| D482,487 S  | 11/2003 | Russello et al.   | D676,177 S *    | 2/2013  | Akinrele .....    | D26/71 |
| D485,636 S  | 1/2004  | Patterson et al.  | D676,179 S *    | 2/2013  | Sandell .....     | D26/85 |
| D496,750 S  | 9/2004  | Waldmann          | D676,180 S *    | 2/2013  | Sandell .....     | D26/92 |
| D568,521 S  | 5/2008  | Compton           | D680,258 S      | 4/2013  | Ahrari et al.     |        |
| D603,077 S  | 10/2009 | Kinnune et al.    | D680,259 S      | 4/2013  | Ahrari et al.     |        |
| D615,234 S  | 5/2010  | Oblak             | D680,676 S *    | 4/2013  | Boyer .....       | D26/92 |
| D634,878 S  | 3/2011  | Guercio et al.    | 8,454,194 B2    | 6/2013  | Liu               |        |
| D634,879 S  | 3/2011  | Guercio et al.    | D713,987 S *    | 9/2014  | Toms .....        | D26/92 |
| D645,604 S  | 9/2011  | Kauffman et al.   | D736,984 S *    | 8/2015  | Dal Ponte .....   | D26/92 |
| D655,848 S  | 3/2012  | Yu Chung Han      | 2011/0210676 A1 | 9/2011  | Beghelli          |        |
|             |         |                   | 2011/0310614 A1 | 12/2011 | Budike, Jr.       |        |
|             |         |                   | 2012/0014099 A1 | 1/2012  | An et al.         |        |

\* cited by examiner



FIGURE 1

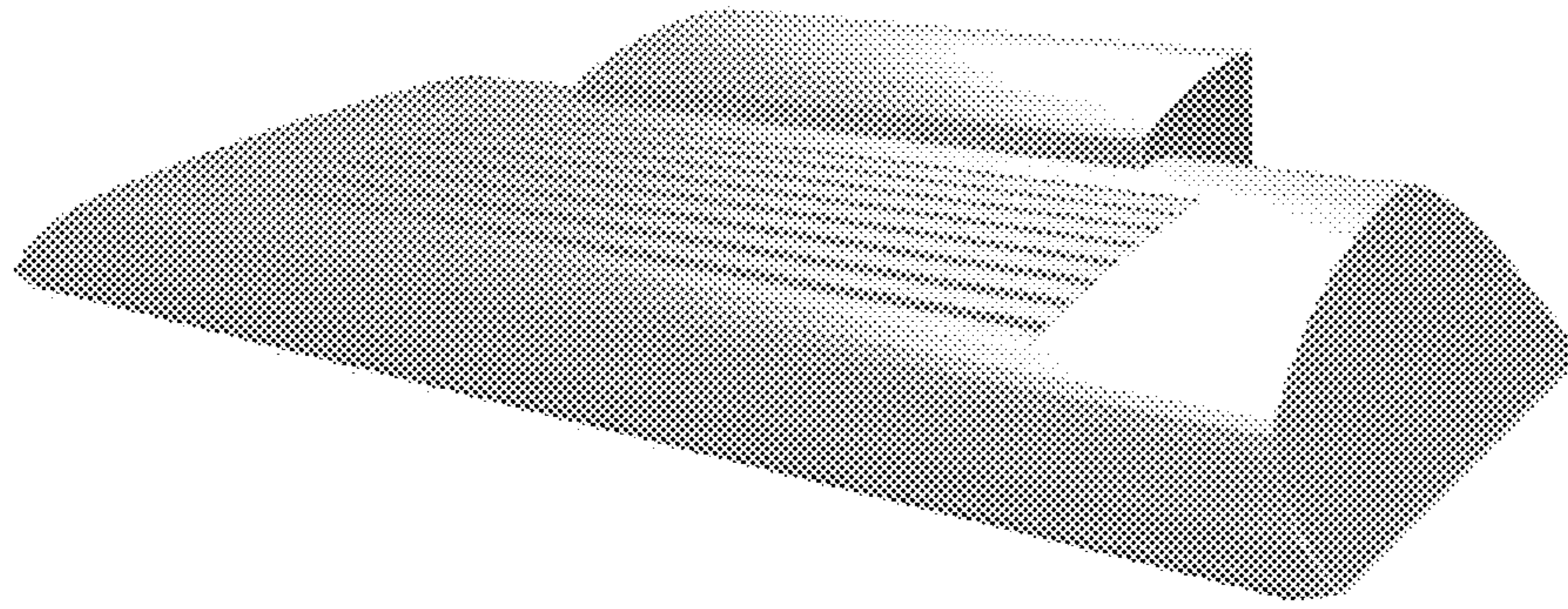

FIGURE 2

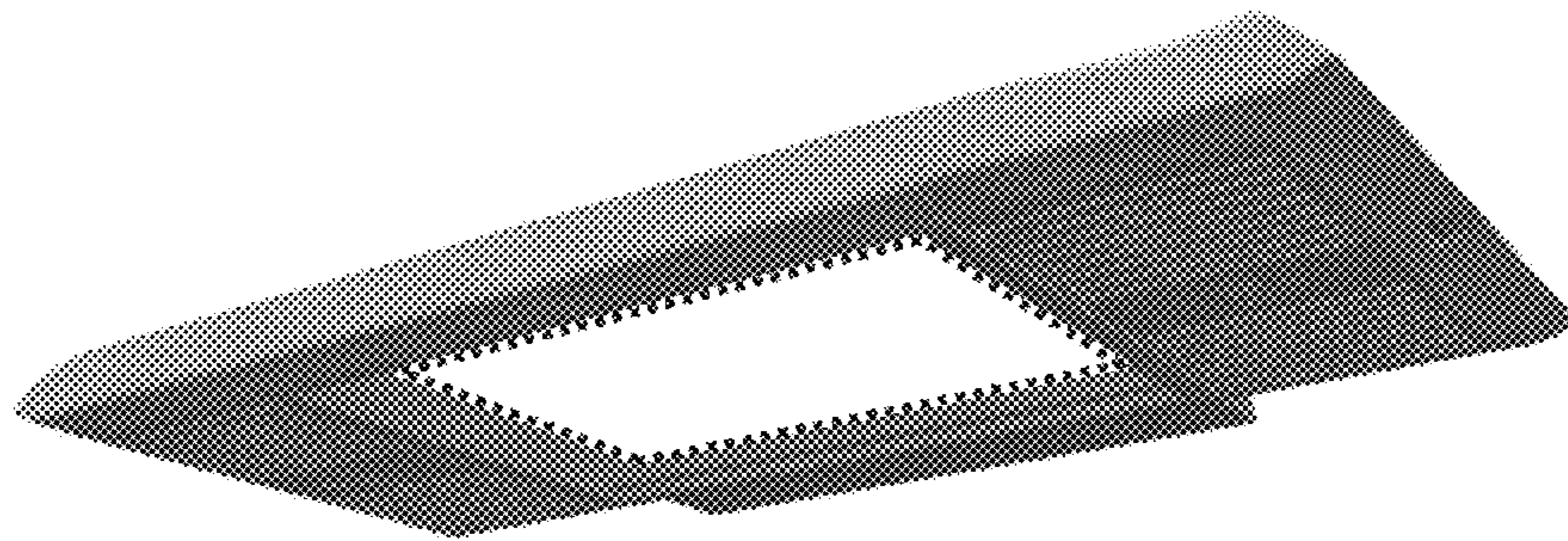

FIGURE 3



FIGURE 4

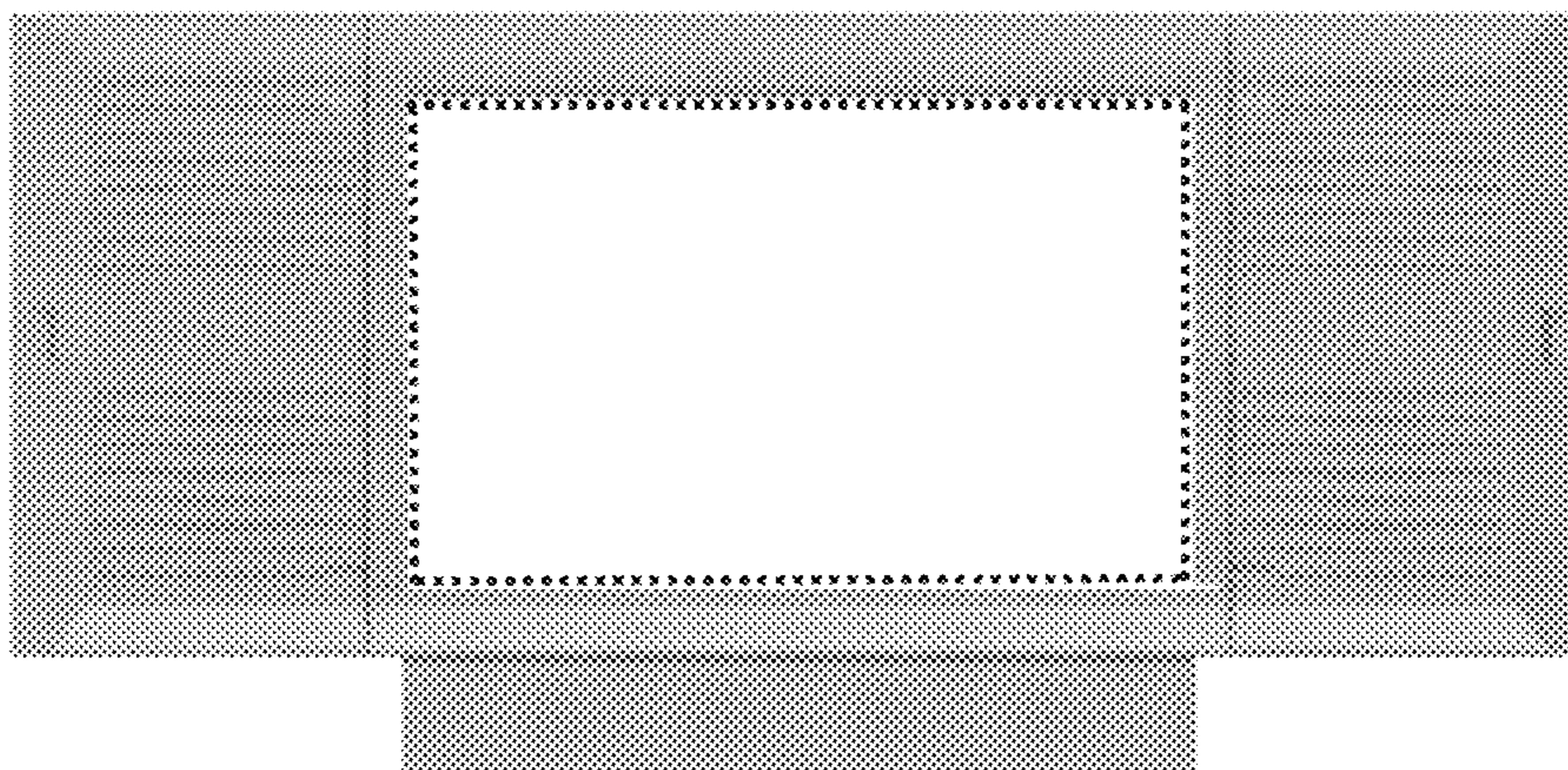



FIGURE 5

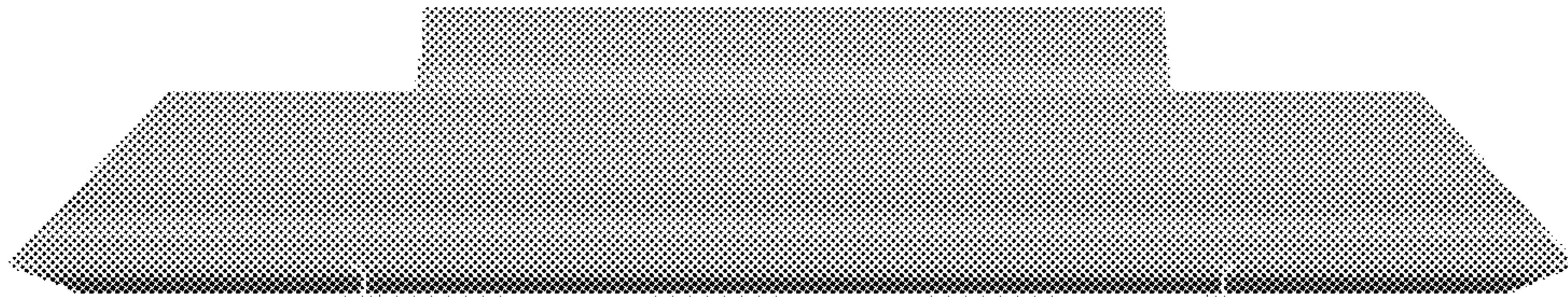

FIGURE 6

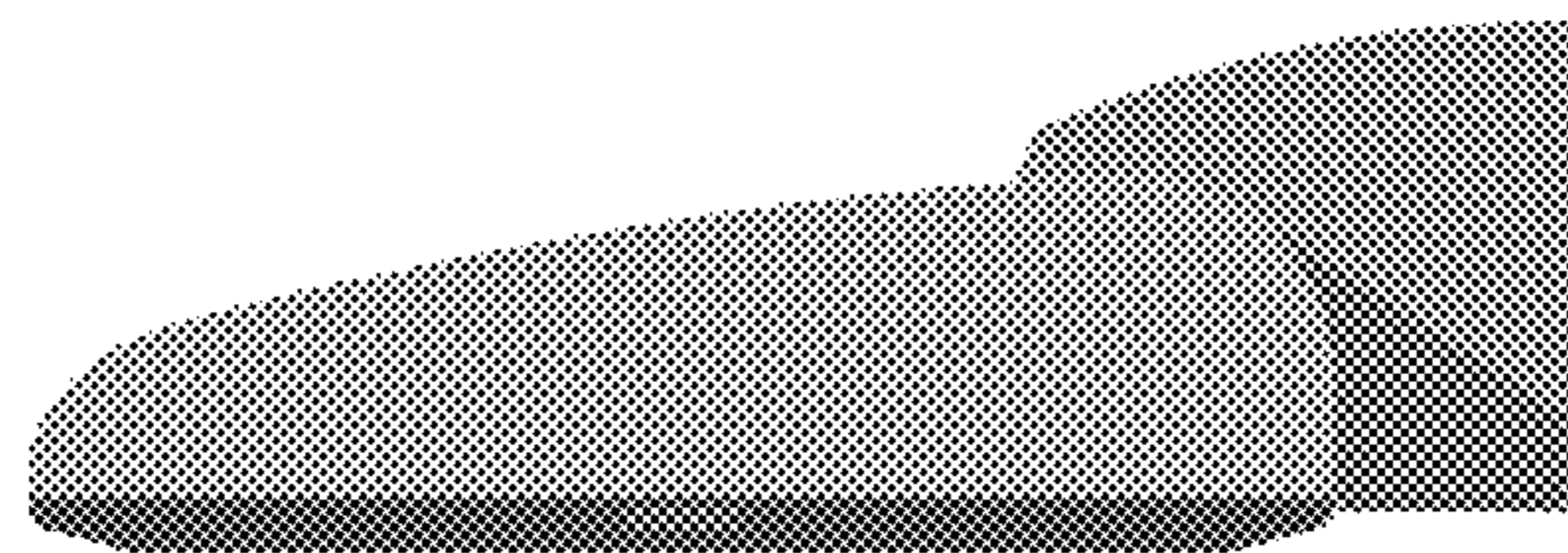

FIGURE 7

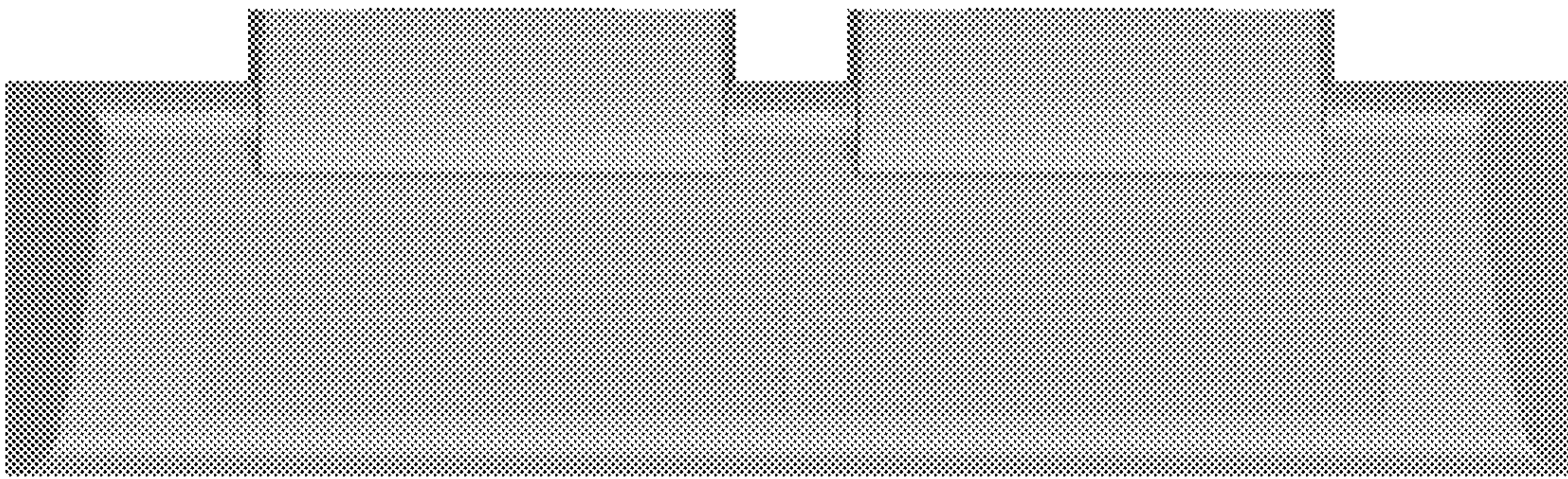

FIGURE 8

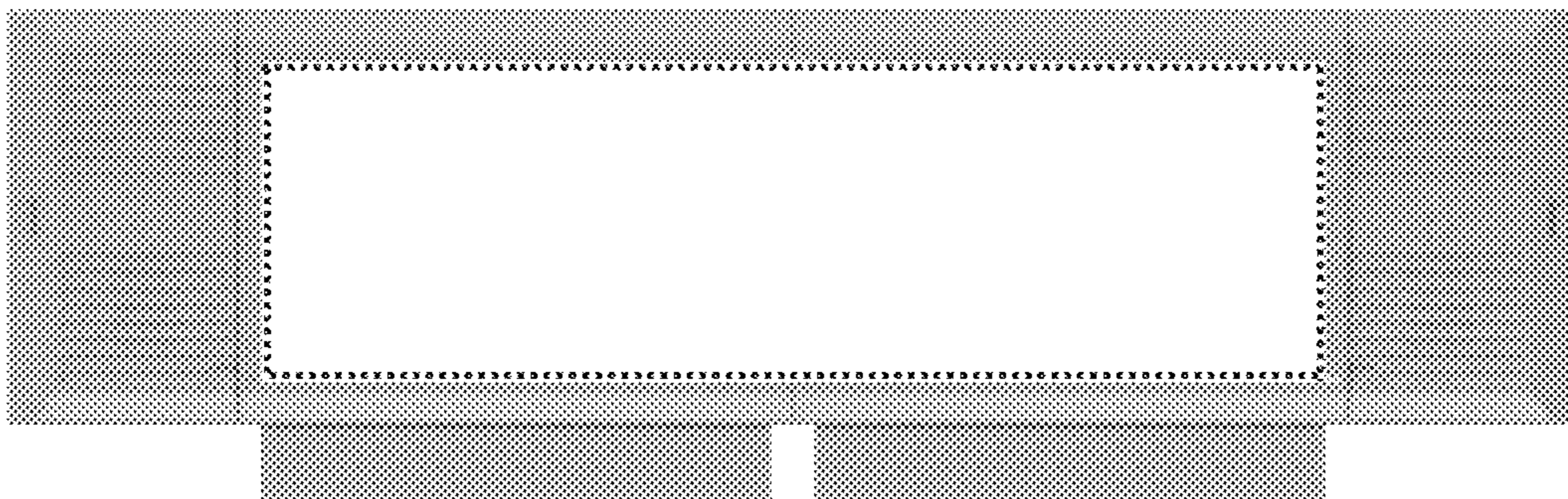

FIGURE 9

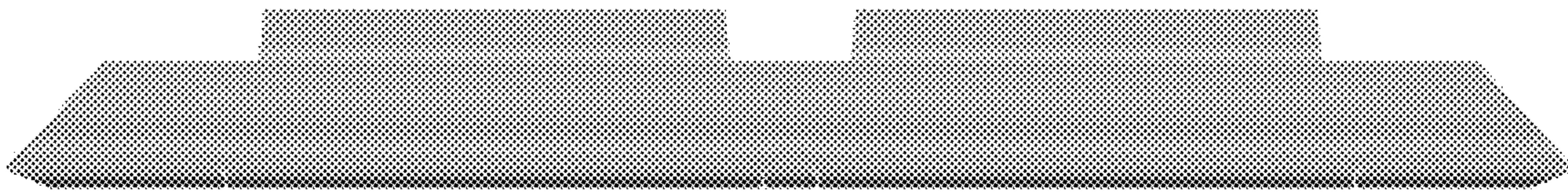

FIGURE 10

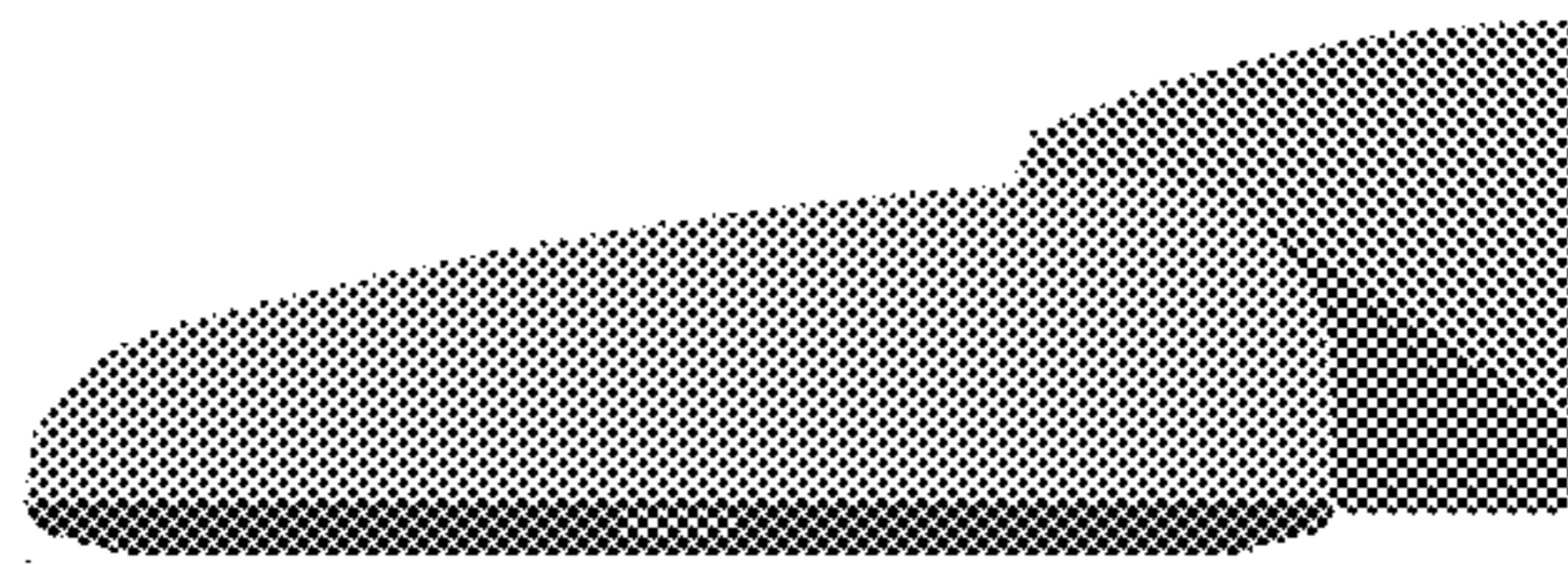



FIGURE 11

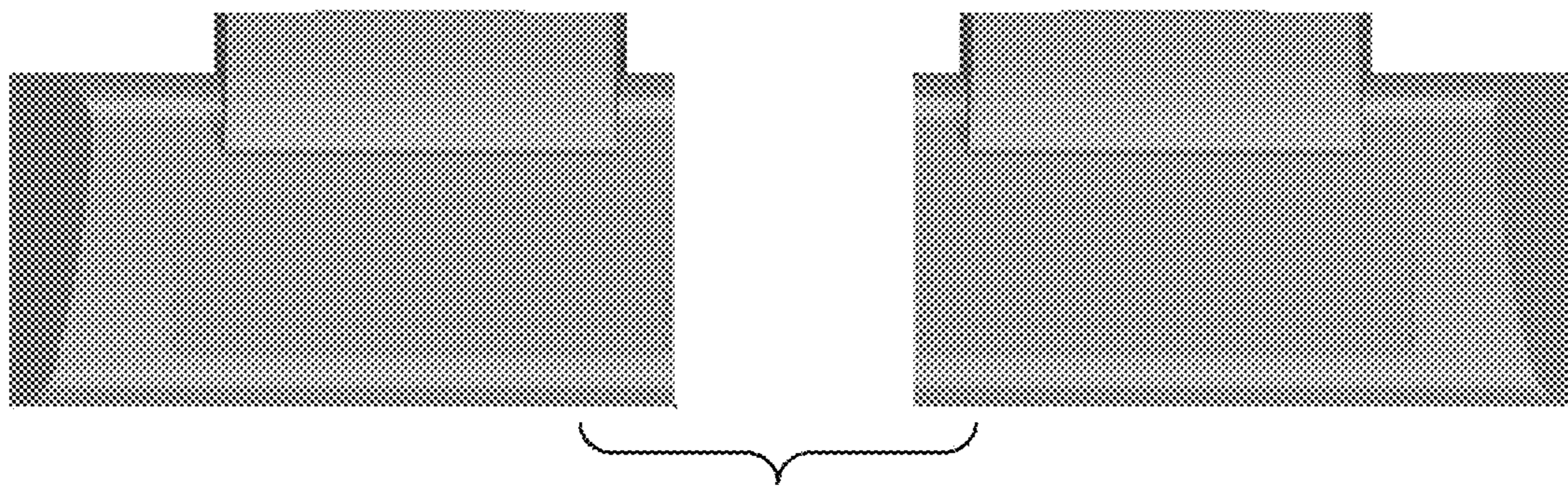

FIGURE 12

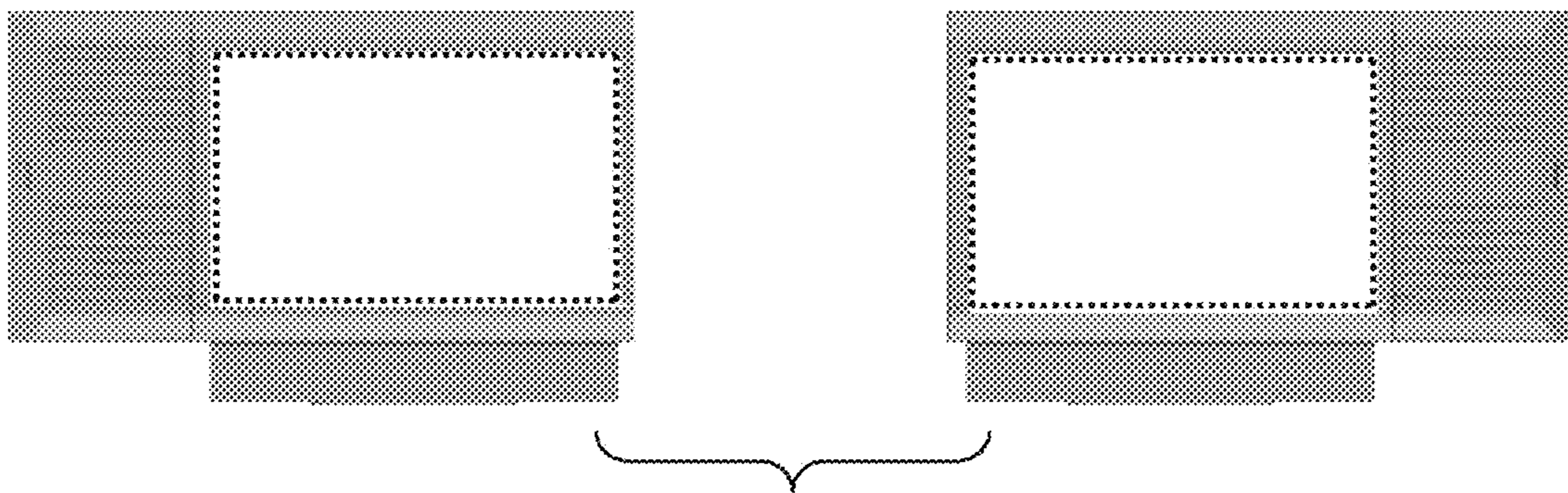



FIGURE 13

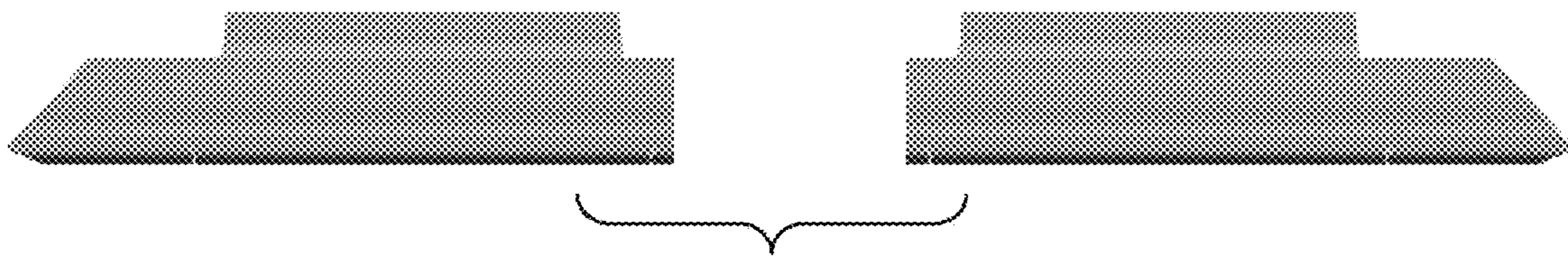

FIGURE 14

