



US00D770662S

(12) **United States Design Patent**
Nicholas

(10) **Patent No.:** **US D770,662 S**
(45) **Date of Patent:** **** Nov. 1, 2016**

(54) **LIGHTING FIXTURE**

(71) Applicant: **The L.D. Kichler Co.**, Cleveland, OH (US)

(72) Inventor: **Kenneth J. Nicholas**, Parma, OH (US)

(73) Assignee: **The L.D. Kichler Co.**, Cleveland, OH (US)

(**) Term: **14 Years**

(21) Appl. No.: **29/513,943**

(22) Filed: **Jan. 7, 2015**

Related U.S. Application Data

(63) Continuation of application No. 29/442,950, filed on Jun. 17, 2013, now Pat. No. Des. 722,402, which is a continuation-in-part of application No. 29/442,532, filed on Mar. 15, 2013, now Pat. No. Des. 728,145.

(51) **LOC (10) Cl.** **26-03**

(52) **U.S. Cl.**
USPC **D26/81**

(58) **Field of Classification Search**
USPC D26/80-91, 118, 152, 155
CPC F21S 8/03; F21S 8/033; F21S 8/036;
F21S 8/04; F21S 8/043; F21S 8/046; F21S
8/06; F21S 8/061; F21S 8/063; F21S 8/065;
F21S 8/068; F21V 1/04; F21V 1/06; F21V
1/12; F21V 3/02; F21V 3/023; F21V 5/06
See application file for complete search history.

(56) **References Cited**

U.S. PATENT DOCUMENTS

D35,908 S * 5/1902 Jamison D26/81
D206,454 S * 12/1966 Rosen D26/80
D252,350 S * 7/1979 Glassman D26/80
D252,531 S * 7/1979 Glassman D26/80
D470,617 S * 2/2003 Dolan D26/81

D481,484 S * 10/2003 Cuevas D26/84
D536,468 S * 2/2007 Crosby D26/84
2015/0116998 A1* 4/2015 Feit F21V 29/70
362/235

OTHER PUBLICATIONS

Gothic Lantern by Neirmann Weeks/ from House Beautiful Nov. 2002.*

(Continued)

Primary Examiner — Clare E Heflin

(74) *Attorney, Agent, or Firm* — Calfee, Halter & Griswold LLP

(57) **CLAIM**

I claim the ornamental design for a lighting fixture, as shown and described.

DESCRIPTION

FIG. 1 is a front perspective view of a lighting fixture. The support arms have three-way, one hundred twenty degree overall rotational symmetry, and the outer frame has four-way, ninety degree overall rotational symmetry. The candles, bobeches, and center stem each have a circular horizontal cross-section.

FIG. 2 is a right side elevational view of the lighting fixture of FIG. 1.

FIG. 3 is a top plan view of the lighting fixture of FIG. 1. FIG. 4 is a front perspective view of a second embodiment of the lighting fixture. Each set of support arms has three-way, one hundred twenty degree overall rotational symmetry, and the outer frame has four-way, ninety degree overall rotational symmetry. The candles, bobeches, and center stem each have a circular horizontal cross-section.

FIG. 5 is a front elevational view of the lighting fixture of FIG. 4; and,

FIG. 6 is a top plan view of the lighting fixture of FIG. 4. The broken lines shown on the drawings depict portions of the lighting fixture that form no part of the claimed design.

1 Claim, 6 Drawing Sheets

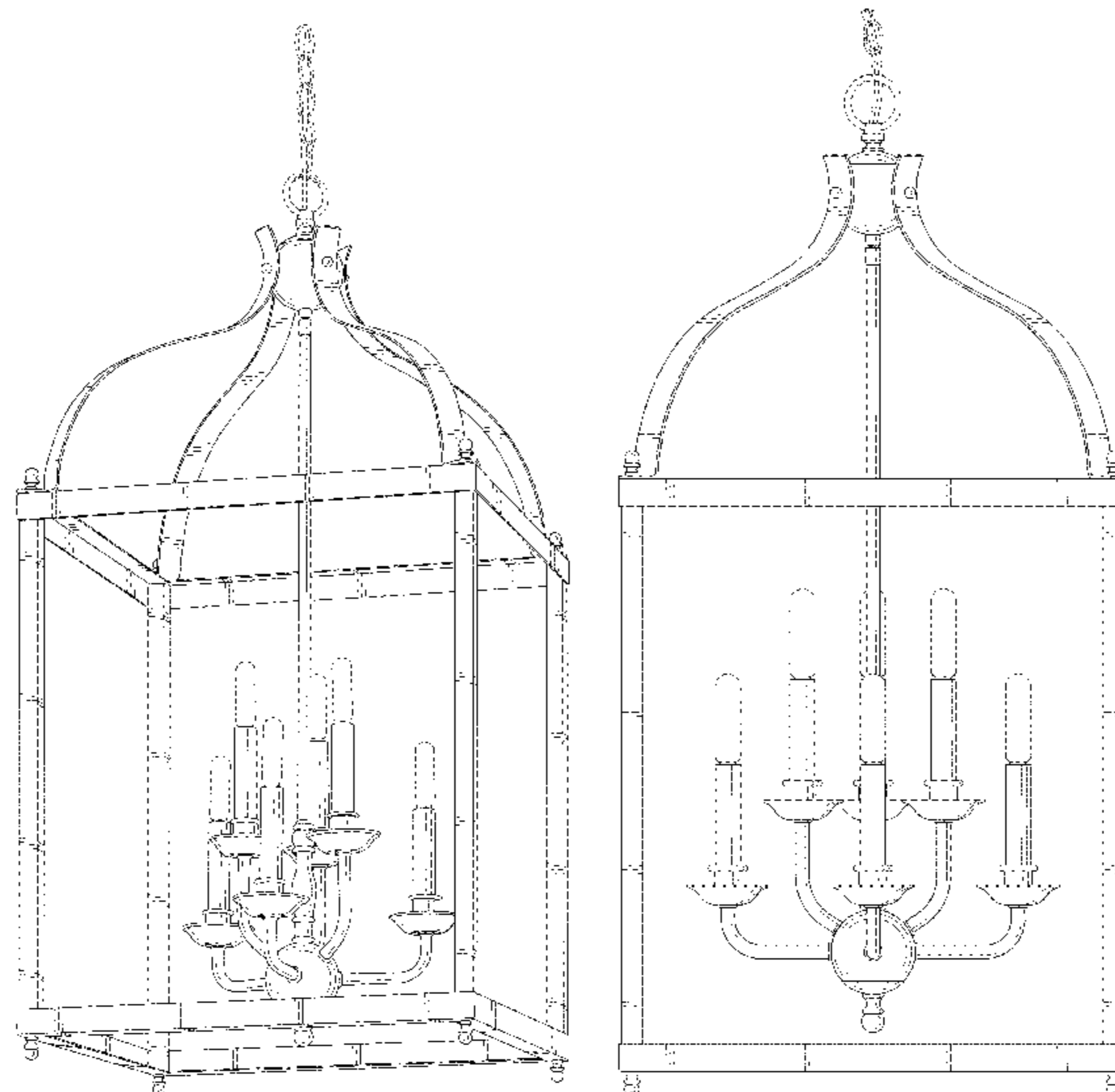

(56)

References Cited

OTHER PUBLICATIONS

Item C on top right of p. 25 in the Restoration Hardware “Famous Fall Lighting Sale” catalog. (3 pages—includes front and rear covers of catalog).*

“Bradford” light fixture shown on pp. 168 and 169 of the Troy Lighting catalog #RCAT-Interior © 2006. (3 pages—includes rear cover of catalog).*

Adams Colonial Pendant Hanging Light item #: LL-133-HA found at lanternland.com, visited Feb. 5, 2016.*

Crabapple 3 Light Foyer Pendant by Savoy House found at wayfair.com, visited Feb. 5, 2016.*

Delaney Pendant Item#: LC661 found at ballarddesigns.com visited Feb. 5, 2016. (2 pages).*

Lincoln 4-Light Pendant Item #: LC816, found at ballarddesigns.com, visited Feb. 5, 2016 (2 pages).*

Kichler “Larkin Collection” found at LightingDirect.com visited Feb. 5, 2016 (2 pages).*

* cited by examiner

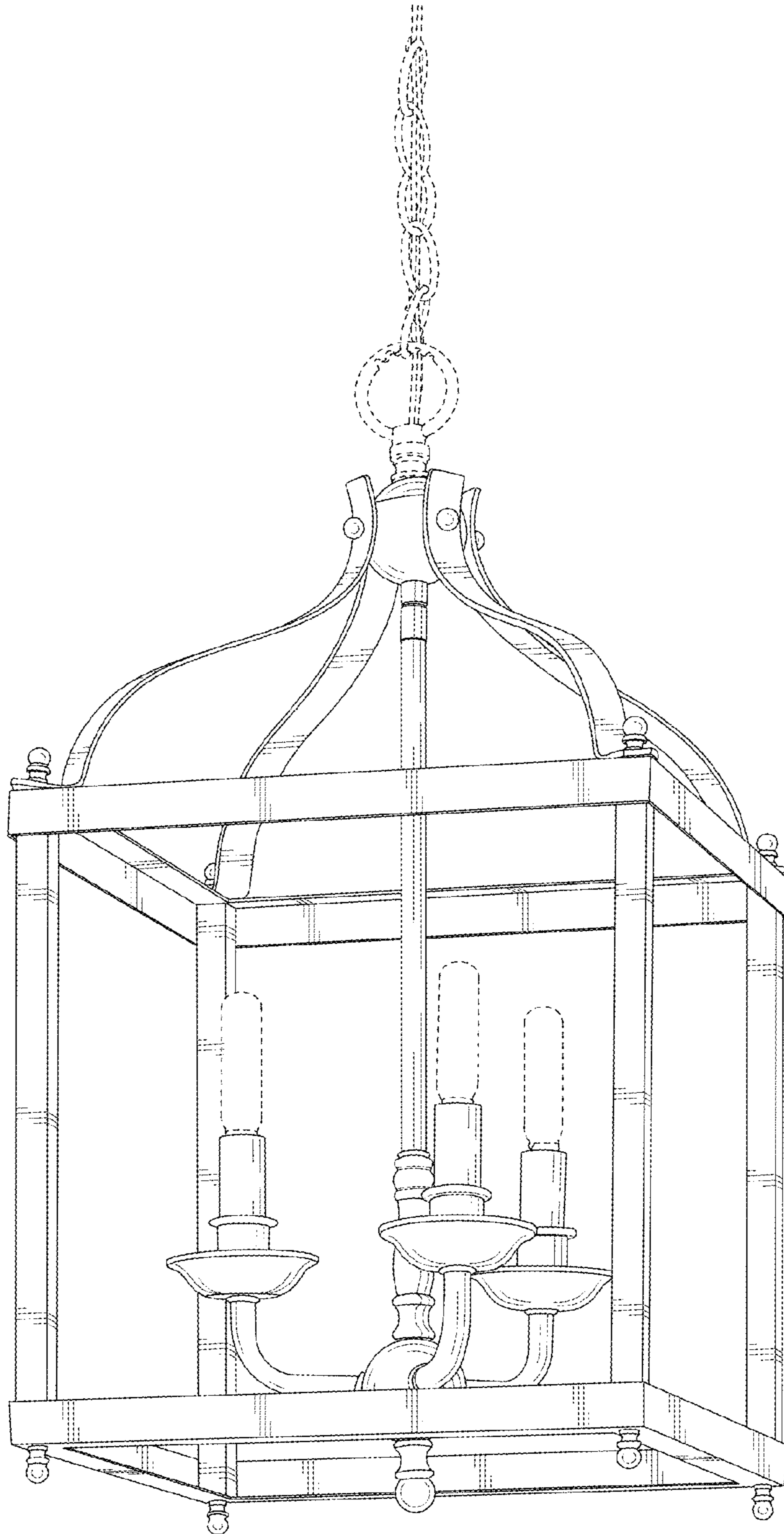

FIG. 1

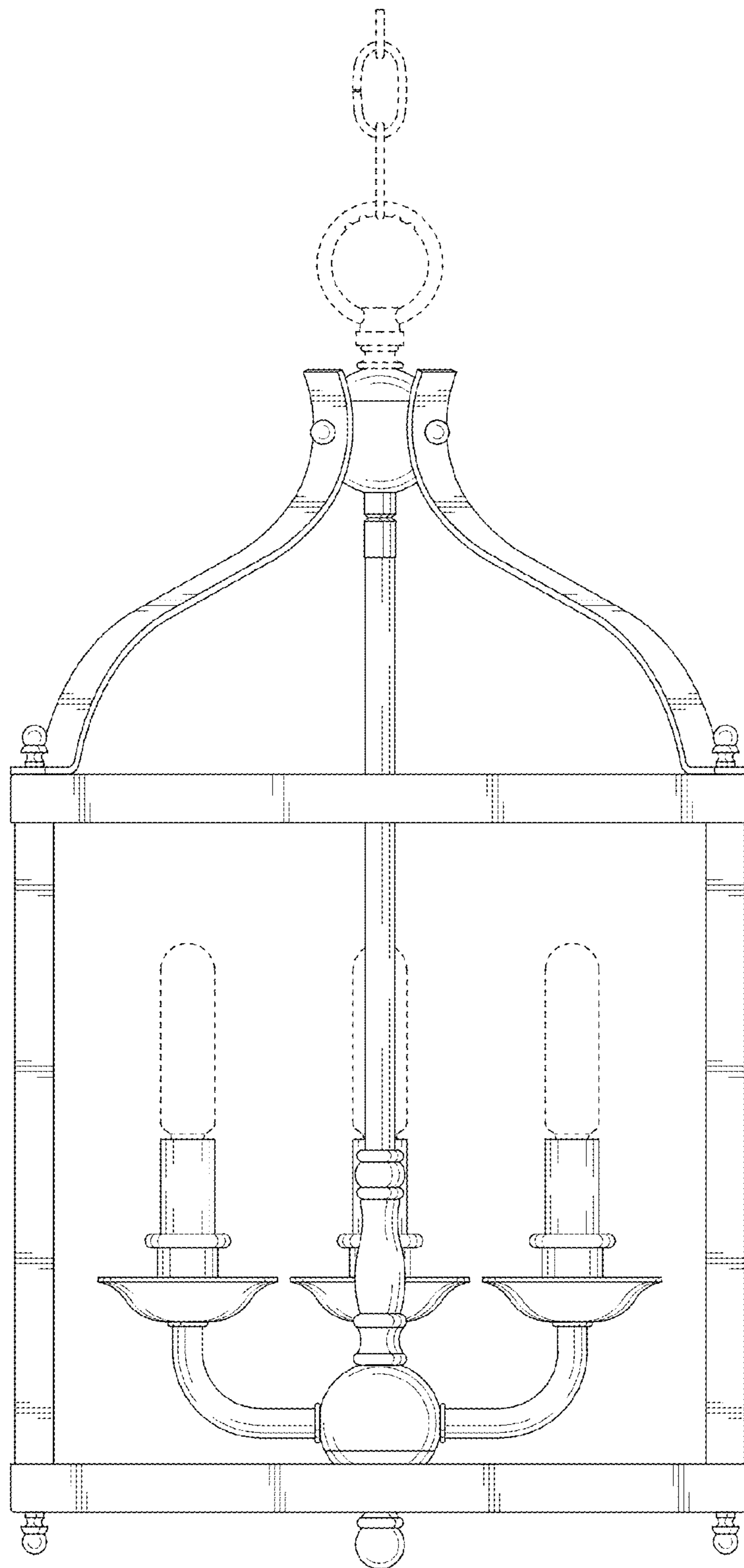

FIG. 2

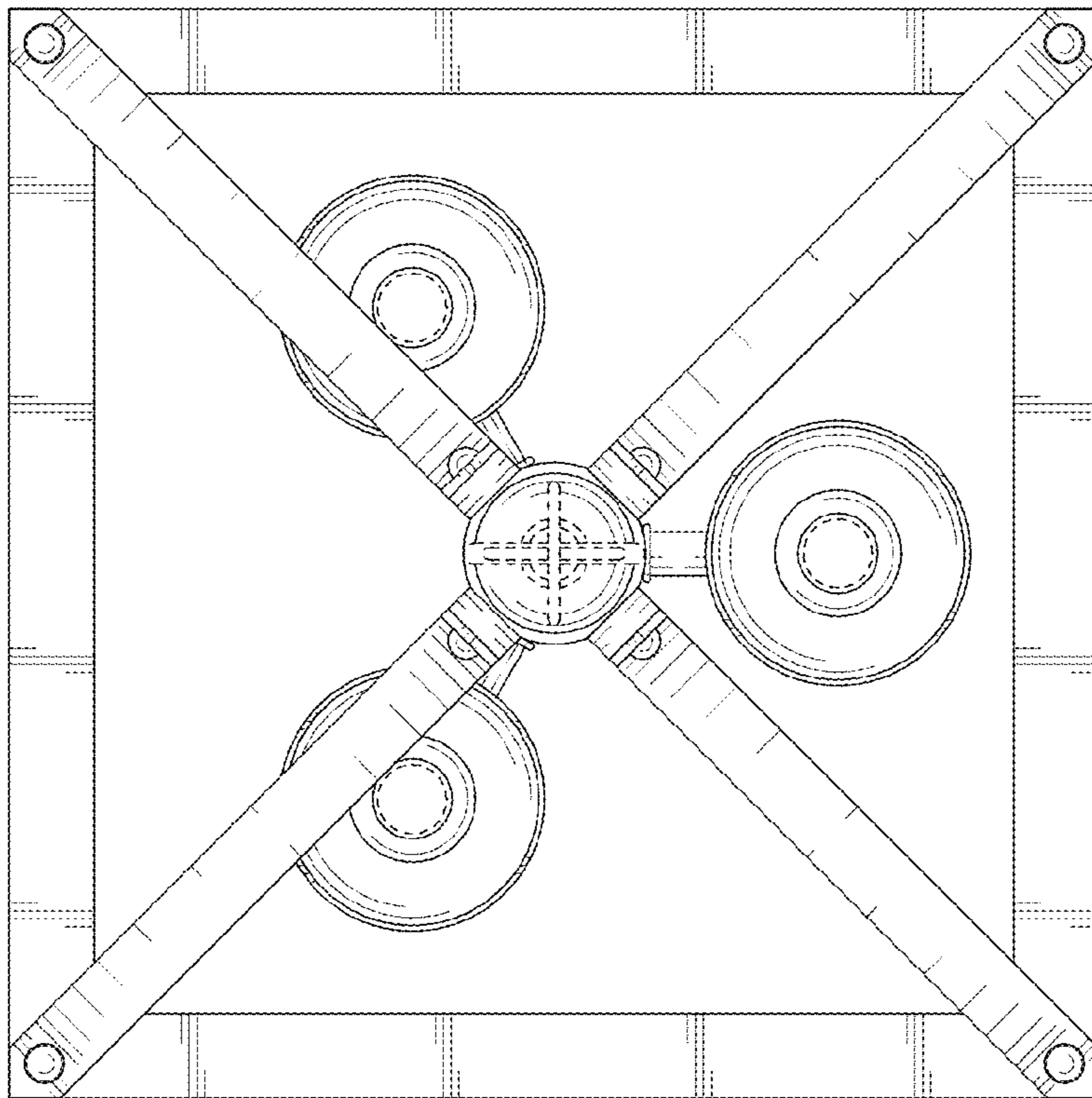

FIG. 3

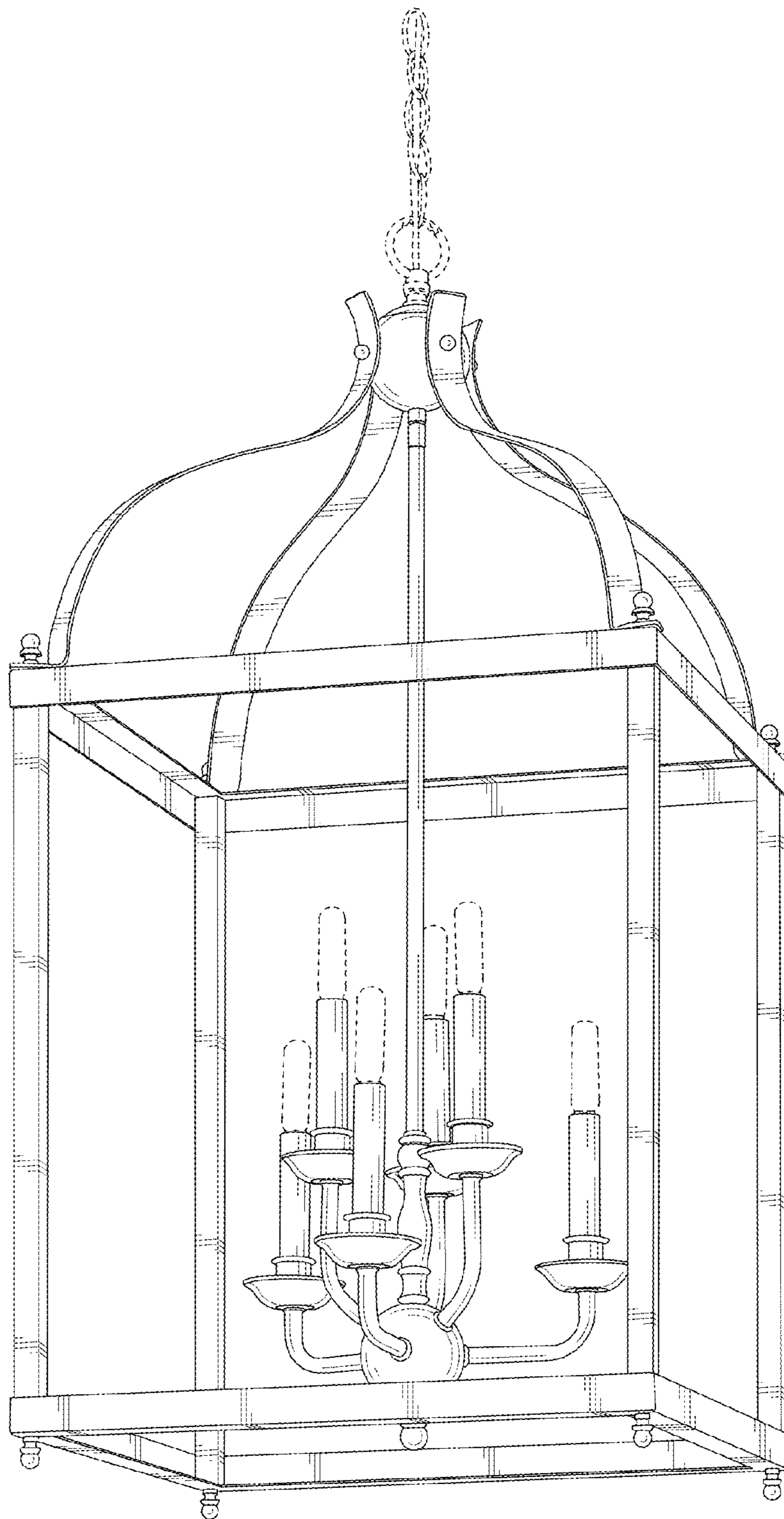

FIG. 4

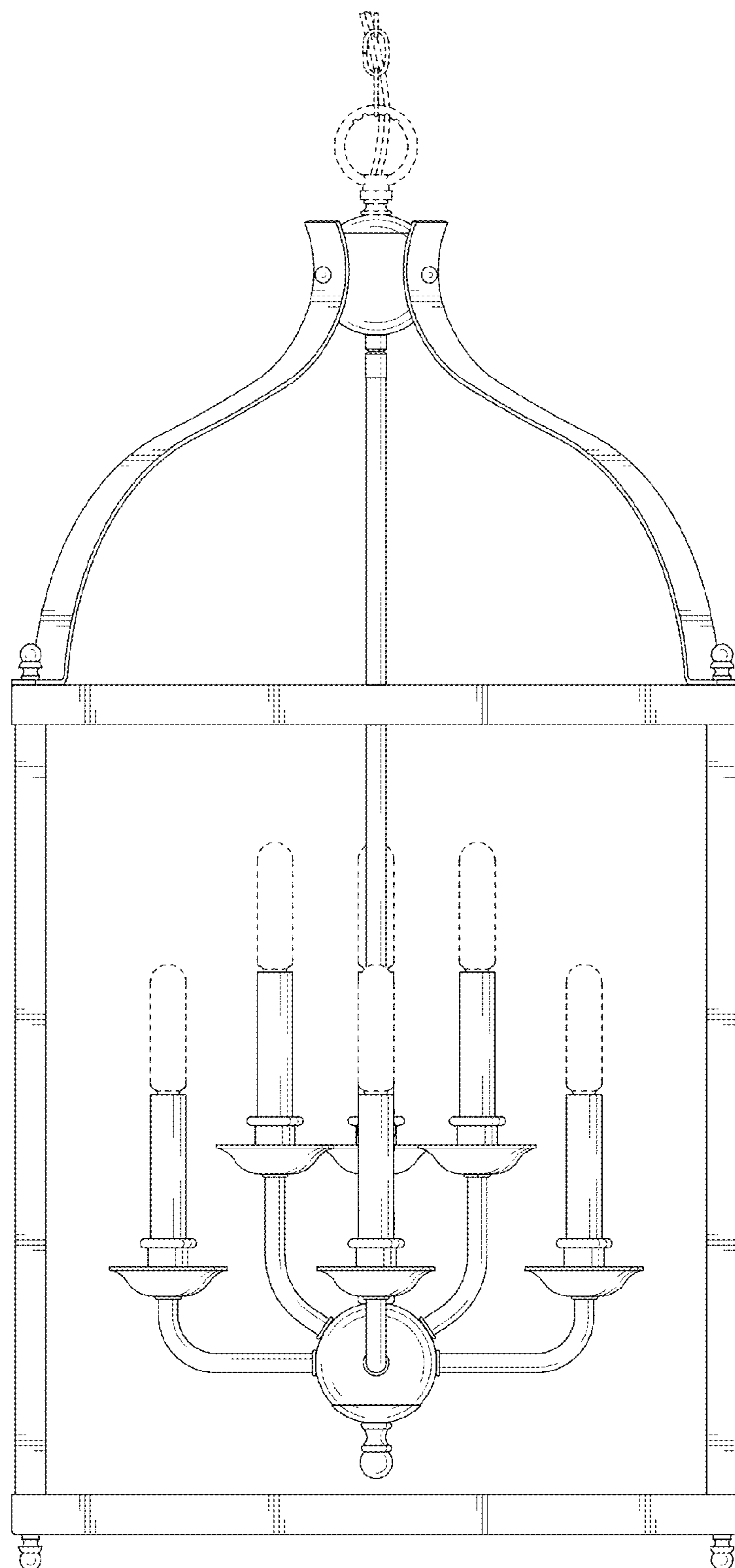

FIG. 5

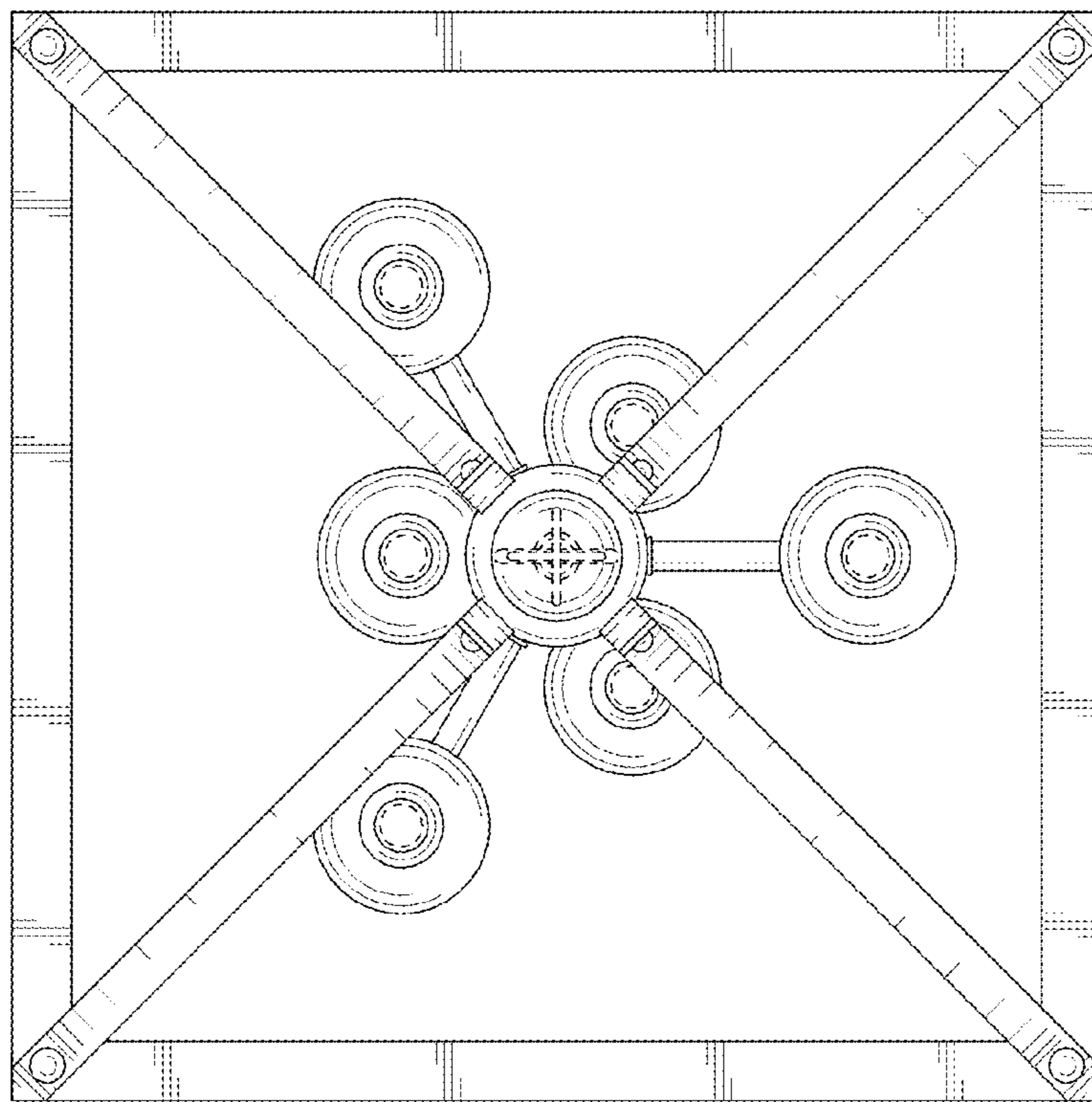

FIG. 6